



For your reference:

Please note that this product is no longer available and is provided as a reference technical document.

FREQUENCY RESPONSE ANALYZER

**FRA5097**

---

**GPIB/USB INSTRUCTION MANUAL**





DA00014285-002

**FRA5097**

**FREQUENCY RESPONSE ANALYZER**

**GPIB/USB INSTRUCTION MANUAL**

**Registered trademark**

National Instruments is a registered trademark of National Instruments Corporation USA.

Other company names and product names are trademarks or registered trademarks of their respective owners.

## INTRODUCTION

This instruction manual describes the FRA5097 GPIB and USB interface. Refer to the separate volume "FRA5097 INSTRUCTION MANUAL" for information on panel operations. The GPIB and USB interface of the FRA5097 has numerous functions, which allow control of nearly all front-panel operations. In addition, settings and measurement data can be read externally.

- The FRA5097 GPIB/USB interface operation manual is comprised of the following sections.

### **1. Preparations Before Use**

Describes the procedures for setting addresses and delimiters of the GPIB, as well as the procedures for resetting the remote status.

### **2. Service Request and Status byte**

Details the service request (SRQ) and the status byte.

### **3. Program Messages**

Describes the formats for program codes, the list of commands, and individual commands.

### **4. Notes for Programming**

Describes cautionary instructions that are specific to the FRA5097, as well as notes for its use.

### **5. Sample Program**

Describes the sample program that uses the GPIB interface.

### **6. Specifications**

Describes the specifications for the GPIB and USB interface of the FRA5097.

---

# Contents

---

1. Preparations before Use.....	1-1
1.1 Overview of the FRA5097 GPIB/USB Interface.....	1-2
1.2 USB Setup .....	1-2
1.3 GPIB Setup .....	1-2
1.4 Interface Selection .....	1-3
1.5 Setting GPIB Addresses.....	1-3
1.6 Setting Delimiters .....	1-4
1.7 USB ID.....	1-4
1.8 Resetting the Remote Status .....	1-5
1.9 Notes.....	1-5
2. Service Request and Status Byte .....	2-1
2.1 Service Request.....	2-2
2.2 Status Byte .....	2-3
3. Program Messages .....	3-1
3.1 Program Codes .....	3-2
3.1.1 Setup Messages .....	3-3
3.1.2 Query Messages.....	3-3
3.1.3 Parameters.....	3-3
3.1.4 Input buffer .....	3-6
3.2 Data Transfer .....	3-7
3.2.1 Transfer of ASCII Format Data.....	3-8
3.2.2 Transfer of Binary Format Data.....	3-9
3.3 Program Code List.....	3-12
3.3.1 Setup Message List.....	3-13
3.3.2 Query Message List .....	3-16
3.4 Individual program code description .....	3-19
4. Notes for Programming .....	4-1
5. Sample Program.....	5-1
5.1 Overview of Sample Program .....	5-2
5.2 Setup and Query .....	5-3
5.3 Setting a Sweep Frequency Range and Sweep Measurement.....	5-5

## Contents

---

5.4	Transfer of Measurement Data to Controller (1) .....	5-7
5.5	Transfer of Measurement Data to Controller (2) .....	5-9
6.	Specifications .....	6-1
6.1	Interface Functions .....	6-2
6.2	GPIB Bus Driver .....	6-2
6.3	Applied Codes .....	6-2
6.4	Answers to Interface Messages.....	6-3
6.5	Multi-line Interface Messagess .....	6-4

---

## Figures

---

Figure 1-1	Status Label .....	1-5
Figure 3-1	Program Code Syntax.....	3-2
Figure 3-2	Data Transfer Procedure.....	3-7

---

## Tables

---

Table 2-1	Status Byte .....	2-3
Table 3-1	Main Header List .....	3-12
Table 3-2	Setup Message List .....	3-13
Table 3-3	Query Message List .....	3-16



# 1. Preparations before Use

<b>1.1 Overview of the FRA5097 GPIB/USB</b>	
Interface .....	1-2
<b>1.2 USB Setup</b> .....	1-2
<b>1.3 GPIB Setup</b> .....	1-2
<b>1.4 Interface Selection</b> .....	1-3
<b>1.5 Setting GPIB Addresses</b> .....	1-3
<b>1.6 Setting Delimiters</b> .....	1-4
<b>1.7 USB ID</b> .....	1-4
<b>1.8 Resetting the Remote Status</b> .....	1-5
<b>1.9 Notes</b> .....	1-5

### 1.1 Overview of the FRA5097 GPIB/USB Interface

The FRA5097 allows nearly all functions to be remotely set via the GPIB or USB. In addition, measurement data and setup conditions can be transferred externally, so that an automatic measurement system can be configured effortlessly.

### 1.2 USB Setup

The FRA5097 can be controlled by the USB Test and Measurement Class (USB-TMC) protocol. Most panel operations can be controlled, allowing the internal statuses, including setting values and errors, to be read.

- The USB connector is located on the rear panel.
- The USB interface is intended for use in a relatively favorable environment. Whenever possible, avoid use where the power supply may frequently fluctuate or be subject to excessive noise.

Install the USB-TMC class driver into the computer used for control and use a commercially available USB cable to connect the computer to the FRA5097. The driver installation file can be downloaded from the National Instruments Corporation website. The procedures for installing the driver are shown below.

1. Search for the VISA Run-time Engine page of the National Instruments Corporation website, or select "VISA driver downloads" at the following URL.  
<http://www.ni.com/support/visa/>
2. Download the VISA Run-time Engine from the VISA Run-time Engine page. User registration is required at this time. Download VISA Run-time Engine Version 3.3 or later.
3. The downloaded file is a self-extracting file. Extract the file and install it.
4. Completion of successful installation means that the USB-TMC class driver has been installed.

For details, visit the National Instruments Corporation website.



### 1.3 GPIB Setup

Mount a GPIB board (card) to the computer to control, using a commercially available GPIB cable. For details, refer to the user's manual that comes with the GPIB controller board (card) to be used.

### 1.4 Interface Selection

Select an interface to use from GPIB or USB. The FRA5097 cannot be controlled through the deselected interface. The selected value is retained by the battery even after the power is turned off.

Note that GPIB is selected upon shipment.

Open menu [Output] [SELECT]; then, select [GPIB] or [USB] from the table using the ITEM   keys.



#### CAUTION

Unexpected operation may occur in some computers if you switch the interface from USB to GPIB or unplug or plug the USB cable when the computer is recognizing the FRA5097,.

---

### 1.5 Setting GPIB Addresses

Use the front panel to set a GPIB address of the FRA5097. Assign a unique value that differs from those allocated to the other components (computer etc.) which are connected via the GPIB cable.

The set value will be battery-protected even when the power is turned off.

The default address is "2."

Open the menu [Output][GPIB][ADDRESS], use the ENTRY keys to input a value between 0 and 30, and then press the  key.

### 1.6 Setting Delimiters

Select GPIB delimiters that will be used for the FRA5097 to transmit data.

Use the front panel to make the settings. Either CR/LF or CR can be selected. An EOI signal will be output concurrently with the final byte of a delimiter. The set delimiter will be battery-protected even when the power is turned off. The default delimiter is "CR/LF^EOI."

Open the menu [Output][GPIB][OUTPUT DELIMITER]; then, select [CR/LF^EOI] or [CR^EOI] from the table using the ITEM   keys.

The delimiter when USB is selected is fixed to "LF".

As a delimiter used for the FRA5097 to receive data, either <CR >, <LF> or an EOI signal or any combination of these can be accepted except for binary format data. Any delimiter that is used when the FRA5097 receives binary format data, will terminate a data transfer with a specified byte count or an EOI signal.

In this instruction manual, a "message terminator" or a "terminator" is referred to as a "delimiter."

### 1.7 USB ID

When more than one FRA5097 are USB connected within the system, use the following numbers for the applications to identify each FRA5097.

- Vendor ID : 3402(0x0D4A)
- Product ID : 10(0x0A)
- Serial number : Product production number (serial number)

The FRA5097 serial number is displayed when the menu [OUTPUT] [USB] is open. You cannot change the FRA5097 serial number.

### 1.8 Resetting the Remote Status

In the GPIB remote mode, REM is shown at the upper right of the LCD. See Fig. 1-1 Status display (reference).

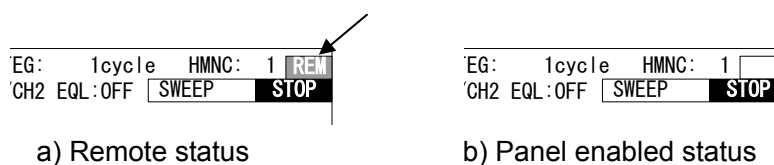

**Figure 1-1 Status Label**

In the remote status, all GPIB or USB operations will be enabled, and any key-in operation from the panel of the FRA5097 will be disabled except the LOCAL key.

To reset the remote status, press the LOCAL key, set the REN line of the GPIB bus to High (False) via the controller, or issue the GTL command. However, the LOCAL key will be disabled as long as the FRA5097 is in the local lockout status. To reset the local lockout status, it is necessary to set the REN line of the GPIB bus to High (False) via the controller.

### 1.9 Notes

- Mate/unmate the GPIB connector in a condition in which all components on the bus are turned off.
- When using the GPIB, turn on all the components on the bus.
- In a system, up to 15 components can be connected to the GPIB, including the controller. As shown below, there are some restrictions on cable length.
  - The total extension of a cable must be 2 m x the number of components or 20 m - whichever is shorter.
  - The length of a single cable must be 4 m or shorter.
- Exercise particular care when setting GPIB addresses. If identical addresses are specified for different components in a system, they may be damaged.
- Exercise particular care when setting delimiters. Unless delimiters are set in a unified manner in a system, unexpected trouble may result.
- The GPIB and USB interfaces are intended for use in a relatively favorable environment. Whenever possible, avoid using the GPIB and USB in a place where the power supply may suffer frequent variations or it is subject to excessive noise.



## **2. Service Request and Status Byte**

<b>2.1 Service Request.....</b>	<b>2-2</b>
<b>2.2 Status Byte.....</b>	<b>2-3</b>

### 2.1 Service Request

A service request (SRQ) is intended to set the SQR signal line of the bus lines to Low (True) and attempt an interrupt to the controller when the transmission of the SRQ is enabled and the FRA5097 is put in any of the following conditions:

- When a sweep is completed
- When one cycle of a manual sweep measurement is completed
- When overload input has taken place during a measurement
- When output data is ready for a query
- When some error has taken place

When an SRQ of the FRA5097 has been detected by the controller and a serial poll has been performed, the FRA5097 will turn down the SRQ after transferring the status byte (see the next section) to the controller.

Once permitted, the transmission of the SRQ will be run whether the status is remote or local.



## 2.2 Status Byte

### 2.2 Status Byte

The FRA5097 status byte contents are indicated in Table 2-1 Status Byte.

Note that some reset conditions are different for GPIB and USB.

**Table 2-1 Status Byte**

Bit	Content	Conditions for Setting to "1"	Conditions for Resetting to "0"
(MSB)7	0	(Unused)	<b>Note 2</b> (Unused)
6	RQS	<ul style="list-style-type: none"> <li>When SRQ is transmitted</li> </ul>	<b>Note 1</b>
5	Error occurred	<ul style="list-style-type: none"> <li>When an error has occurred</li> </ul>	<b>Note 4</b> <ul style="list-style-type: none"> <li>When an error code is read</li> </ul>
4	0	(Unused)	<b>Note 2</b> (Unused)
3	Output ready	<b>Note 3</b> <ul style="list-style-type: none"> <li>When output data is ready for a query</li> </ul>	<b>Note 4</b> <ul style="list-style-type: none"> <li>When a subsequent query message is received</li> </ul>
2	Overvoltage input occurred	<ul style="list-style-type: none"> <li>When overvoltage input has occurred</li> </ul>	<b>Note 4</b> <ul style="list-style-type: none"> <li>When a normal measurement ends</li> <li>When a subsequent sweep is started</li> <li>When an error code is read</li> </ul>
1	Measure end	<ul style="list-style-type: none"> <li>When one cycle of a manual sweep measurement ends via GPIB</li> <li>When a calibration ends</li> </ul>	<b>Note 4</b> <ul style="list-style-type: none"> <li>When a subsequent measurement is started</li> <li>When a subsequent calibration is started</li> </ul>
(LSB)0	Sweep end	<ul style="list-style-type: none"> <li>When a sweep ends after reaching the maximum or minimum</li> </ul>	<b>Note 4</b> <ul style="list-style-type: none"> <li>When a subsequent sweep is started</li> </ul>

**Note 1** : • When a DCL or SDC (device clear) is received.  
 • After the status byte is read (due to a serial poll while an SRQ is being output or in response to a query message).

**Note 2** : • Constantly 0 because this is not used.

**Note 3** : • If this setting is made when output data is ready for a query, then the setting will remain even after the data has been output. The SRQ will be transmitted immediately if the transmission of the SRQ (service request) is then enabled for "Output ready" in response to the setup message "SRqenable 8".

**Note 4** : • When a device clear (DCL or SDC) signal is received.  
 • GPIB : After serial poll during the SRQ output, and also after reading the status byte as requested by a query message.  
 • USB : After reading the status byte as requested by a query message.  
 For USB, execution of a serial poll does not result in clearing.



## 3. Program Messages

3.1	Program Codes .....	3-2
3.1.1	Setup Messages .....	3-3
3.1.2	Query Messages .....	3-3
3.1.3	Parameters .....	3-3
3.1.4	Input buffer .....	3-6
3.2	Data Transfer .....	3-7
3.2.1	Transfer of ASCII Format Data .....	3-8
3.2.2	Transfer of Binary Format Data .....	3-9
3.3	Program Code List .....	3-12
3.3.1	Setup Message List .....	3-13
3.3.2	Query Message List .....	3-16
3.4	Individual program code description .....	3-19

3.1 Program Codes

If a program code contains an unspecified header or parameter, the input buffer will be cleared when the program code is interpreted, and no subsequent program code will be executed.

A program code is composed of a header part and a parameter part that follows it, which are divided by ";" (semicolon). The program code syntax is as follows:

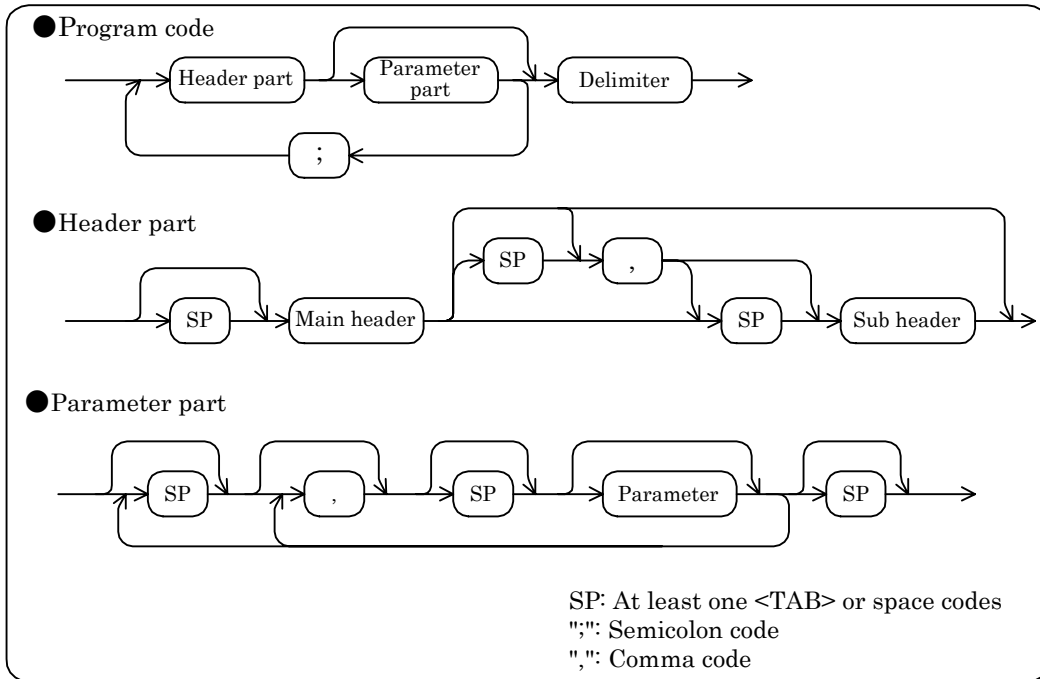

Figure 3-1 Program Code Syntax

A header part is comprised of one main header and two or more sub headers whose number depends on the main header (however, a header part may contain optional sub headers or no sub header). The main header and sub headers are divided by at least one <TAB>, space or "," (comma).

**Ex:** osc offset <parameter part>  
 sweep resolution log decade <parameter part>  
 ?identifier No parameter contained

When a header part so requires, its parameter part is made up of the required number of parameters which are divided by ",", however a parameter part is generally optional. In addition, either the numerical format or string (mnemonic) format can be used for the parameter part.

**Ex:** sweep range <minimum>, <maximum>  
 sweep range <minimum>, The maximum is optional  
 sweep range <minimum> Same as above  
 sweep range ,, <maximum> The minimum is optional

### 3.1.1 Setup Messages

Setup messages refer to the program codes that are intended to make a range of settings for the FRA5097 and instruct it to perform its functions.

### 3.1.2 Query Messages

Query messages refer to the program codes whose header parts are all prefixed with "?" (a question code). They are intended to run queries about the status, setups or measurement data of the FRA5097 and prompt the FRA5097 to output answer messages to them. Query messages generally have corresponding setup messages, except some exceptional ones. Any query message, which has the corresponding setup message, is represented by that setup message, except that its header part is prefixed with "?" (a question code).

When the FRA5097 has received a query message, it will get ready to respond to it by checking the relevant status, setups or measurement data. If the FRA5097 is then specified as a talker, it will output an answer message to the query. Any query message that has a corresponding setup message, follows the format of that setup message. Also, a header can be appended to a query message using the header setup message "SETUP HEADER ON" The status will become "SETUP HEADER OFF" by power on or when a DCL or SDC (device clear) is received.

There are setup messages for data such as measurement data to specify data formats. If a format is specified by a setup message, then the specified format will be used for that data. When more than one query is put to the FRA5097 at a time, the FRA5097 will receive only the final query and ignore all preceding queries. Also, when the FRA5097 receives a new query before completing the output to a previous query, it will start output to the new query.

### 3.1.3 Parameters

There are parameters in numeric and string formats.

#### a) Parameters in numeric format

According to individual setup items, the following three numeric formats are available for parameters used in setup messages or for answer messages to be output to query messages.

- NR1 format Integer format
- NR2 format Real number format
- NR3 format Real number format (exponent format)

(Contd.)

● NR1 format

The NR1 is an integer format (a format using numbers that do not include any decimal point. The decimal point of an integer is implicitly regarded as being placed at the end of its final digit).

±DDDD

- ⊙ At the time of input, any reading zero or space is ignored.
- ⊙ At the time of output, a reading zero is a space.
- ⊙ The sign is represented by "+" and "-".
- ⊙ If the sign is omitted at the time of input, it will be interpreted as "+".  
Any number of digits can be used.
- ⊙ At the time of output, "+" may be represented by a space according to the setup item. The fixed number of digits is used according to the setup item.

**Ex:** +01234  
-500  
18

● NR2 format

The NR2 is a real number format (a format using numbers that include decimal points, each of which is represented by "." (period)).

±DD. DD

- ⊙ At the time of input, any reading zero or space is ignored.  
If the numeric value before the decimal point is omitted, the integer part will be interpreted as 0.
- ⊙ At the time of output, a reading zero is a space.
- ⊙ The sign is represented by "+" and "-".
- ⊙ If the sign is omitted at the time of input, it will be interpreted as "+".  
Any number of digits can be used.
- ⊙ At the time of output, "+" may be represented by a space according to the setup item. The fixed number of digits is used according to the setup item.

**Ex:** +012.34  
-50.0  
1.8

● NR3 format

The NR3 is a real number (exponent) format.

±DD. DD E±DD

- ⊙ Exponent part
- ⊙ At the time of input, any reading zero or space is ignored.  
The sign is represented by "+" and "-". If the sign is omitted, it will be interpreted as "+". Any number of digits can be used.
- ⊙ At the time of output, a reading zero is "0" rather than a space.  
The numeric value is a multiple of 3 and is composed of "E" + Sign + 2-digit number, for which fixed 4 digits are used.
- ⊙ Same as NR2 format.

**Ex:** +0.1234E +03  
-50.0E -06  
1.8E-9

To set a floating-point number as a parameter in a setup message, any of the three formats (NR1, NR2 and NR3) can be used.

To set an integral number as a parameter in a setup message, only the NR1 format can be used.

In actuality, a value that is set in a setup message will be rounded so that it will be within each parameter's resolution. Therefore, if a higher-digit number is specified, some digits that follow a certain number of digits will be discarded (rounded off). Even in this case, however, normal scaling will be performed for a decimal point or for exponents, if any.

#### b) Parameters in string format

To use data in string format as a parameter in a setup message or to transmit data in string format in response to a query message, the following formats are available:

- Mnemonic (string) format
- General string (title etc.) format

#### ● Mnemonic (string) format

For parameters in NR1 or string format, the mnemonic (string) format can be substituted for the integer (NR1) format.

For reception, the FRA5097 can use either of the integer and mnemonic formats.

In mnemonic format, an intended string can be written as is. The mnemonic format is case-independent.

The FRA5097 can transmit in mnemonic format in response to the mnemonic setup message "SETUP MNEMONIC ON" Also, the FRA5097 will output in uppercase without any truncation.

**Ex:**     OSCILLATOR MODE ON,Quick,zero  
          DISPLAY ANALYSIS CH1BYCH2

(Contd.)

- General string (title etc.) format

Follow the notation shown below for any other general string format. Note that any string output by the FRA5097 will be enclosed with [""] (a double quotation).

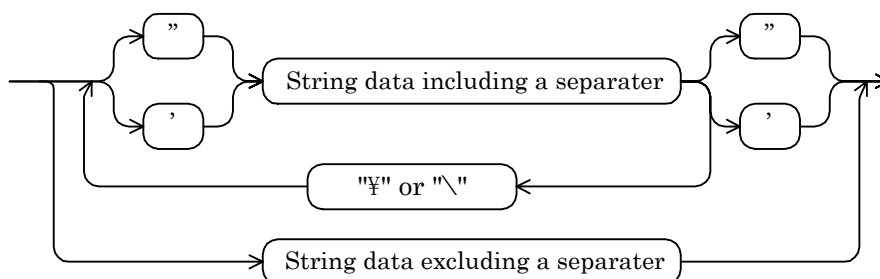

Separator: Either SP, ", " or ";"  
 SP: At least one <TAB> or space code  
 ": Double quotation code  
 ': Single quotation code  
 "¥" or "¥": "¥" for JIS and "¥" for ASCII. These are used when ', ',  
 "¥" or "¥" should be contained in a string.

**Ex:** data write title <tag number>, 'sample title'  
 file load disk DATA.DAT, <tag number>  
 data write title <tag number>, "include quote mark like as \', \\ and \' , "  
     The string to be passed is: include quote mark like as",\ and' .  
 data write title <tag number>, "these ; , aren't terminators."  
     The string to be passed is: these ; , aren't terminators.

#### 3.1.4 Input buffer

- You can send as many commands as possible at once, provided the total contents fit within the input buffer capacity (4096 bytes).
- The sent commands are first stored in the input buffer, then they are interpreted and executed one at a time.
- When an improper command found during an interpretation or an execution, an error is issued, and subsequent executions are aborted.
- Once the interpretations and executions are completed, the input buffer is cleared, and inputting of next command becomes possible.
- When sending a large size data (for instance a "DAta Write data" command), divide such data to be below the buffer capacity before transferring.



### 3.2 Data Transfer

The FRA5097 can output/receive data to/from the controller using a data transfer message.

The data transfer procedure is shown below.

Refer to "3.3 Program Code List" for details on program codes.

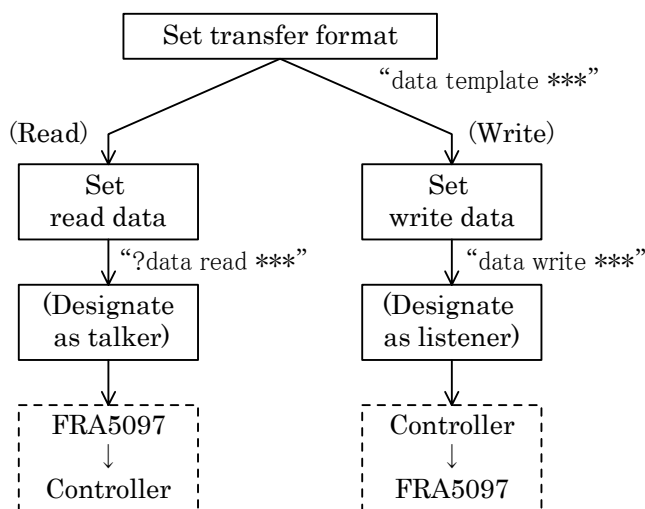

Figure 3-2 Data Transfer Procedure

- **Specifying the transfer format**

The format of data to be transferred (binary or ASCII) and its configuration (types or combinations of frequency, gain, phase etc.) can be set by means of the setup message "data template"

- **Reading data (data output)**

If the FRA5097 has been specified as a talker after receiving the query message "?data read" in which the number of data to be read is defined by a parameter, it will output the data to the controller.

- **Writing data (data input)**

If the FRA5097 has received the setup message "data write" in which the number of data to be written is specified by a parameter, it will receive the data from the controller. The type of the written data is "OPERATED" which indicates that the data has undergone an arithmetic calculation.

### 3.2.1 Transfer of ASCII Format Data

The FRA5097 will transfer data in ASCII format if the data transfer format is set to ASCII through the setup message "data template string".

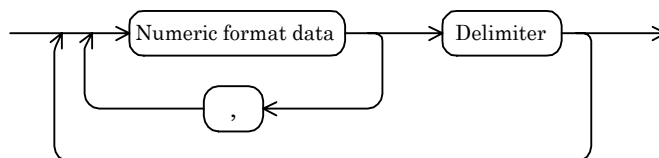

The measurement data in ASCII format refers to a series of numerical data blocks, of which the number and configuration are pre-defined. "," (commas) are used between individual data in a block. Interblock delimiters are as follows:

- At time of reception : Either <CR>, <LF> or EOI or any combination of these can be accepted.
- At time of transmission : The delimiter that was selected from the menu [Output][GPIB] [OUTPUT DELIMITER] will be used. However, no EOI is appended to an interblock delimiter.

The pre-defined number of blocks will be transferred.

Shown below are the I/O form and transfer format that are used at power-on or when a DCL or SDC (device clear) is received:

- Transfer format: ASCII format
- Per-block configuration: <frequency (Hz)>, <gain (dB)>, <phase (deg)>  

NR2	NR2	NR2
17 characters	8 characters	7 characters

#### a) Example of ASCII format data transmission from FRA5097

- Setup message to FRA5097

data template string, sweep, logr, theta (delimiter)

Per-block configuration : <frequency>, <gain (log)>, <phase> in ASCII format

?data read data 1,0,3 (delimiter)

Transfers **3** blocks of data starting at block **0** of tag **1**

- Answer from FRA5097

1000000.0000, 123.450, -134.23 (block delimiter)

100000.0000, 0.012, 0.34 (block delimiter)

1000.0000, -84.544, 140.33 (delimiter)

### b) Example of ASCII format data reception by FRA5097

- Setup message and transfer data to FRA5097

data template string, 1, 5, 6 (delimiter)

Per-block configuration : <frequency>, <a>, <b> in ASCII format

data write data 1, 3, 2 (delimiter)

Writes **2** blocks of data starting at block **3** of tag **1**

1.0E+6, 1.0, -1.000 (delimiter)

1.0E+6, -2.23, 2.34 (delimiter)

The data received will be written as operated data (OPERATED).

### 3.2.2 Transfer of Binary Format Data

When the data transfer format has been set to anything other than "string" via the setup message "data template" the FRA5097 will transfer the data in the specified binary format.

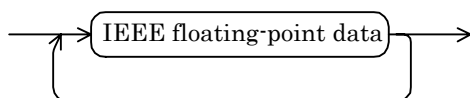

The measurement data in binary format refers to a series of floating-point data blocks in IEEE 754 (subset), of which the number and configuration are pre-defined. There is no delimiter between individual data in a block or between blocks.

No delimiter setting is required for the entire data, either. At the time of reception, a data transfer will terminate when a specified byte count or an EOI message is received, while at the time of transmission, a data transfer will terminate when an EOI is output together with the final byte of the entire data row.

#### c) Example of binary format (IEEE Double) data transmission from FRA5097

- Setup message to FRA5097  
data template double, sweep, logr, theta (delimiter)  
Per-block configuration : <frequency> <gain (log)> <phase> in IEEE Double  
The size of a single block is 8bytes x 3 = 24bytes  
?data read data 2, 10, 200 (delimiter)  
Transfers **200** blocks of data starting at block **10** of tag **2**

- Answer from FRA5097

#504800 4,800bytes data row in IEEE Double format (delimiter)  
#: Indicates the binary data format.  
5: Indicates that the decimal digit string showing the byte count of the data is in five digits.  
04800: Indicates that the data is 4,800bytes (24bytes per block x 200 blocks).  
(delimiter): Indicates the delimiter that was selected from the menu [Output][GPIB][OUTPUT DELIMITER] (CR/LF^EOI or CR^EOI).

#### d) Example of binary format (IEEE Float (reverse byte order)) data reception by FRA5097

- Setup message and transfer data to FRA5097  
data template invfloat, sweep, r (delimiter)  
Per-block configuration : <frequency> <gain> in IEEE Float (reverse byte order)  
The size of a single block is 4bytes x 2 = 8bytes.  
data write 3, 100, 10 (delimiter)  
Writes **10** blocks of data starting at block **100** of tag **3**

#3080 80bytes data in IEEE Float format (reverse byte order)  
#: Indicates the binary data format.  
3: Indicates that the decimal string showing the byte count of the data is in 3 digits. An ASCII character between 1-9 can be specified.  
080: Indicates that the data is 80bytes (8bytes per block x 10 blocks).

An EOI is appended to the final data byte.

Even when the FRA5097 has received an EOI during data reception (when it has not completed receiving a specified byte count), it will terminate the reception of the binary data after receiving the bytes that have reached up to that time.

**e) IEEE floating point format**

Through the setup message "data template", the following four IEEE floating point formats can be used as a transfer format for measurement data or operated data:

- IEEE double-precision floating point format (big endian)
- IEEE single-precision floating point format (big endian)
- IEEE double-precision floating point format (little endian)
- IEEE single-precision floating point format (little endian)

● IEEE double-precision floating point format in normal byte order (8bytes per data)

Transfer order

1	2	3	4	5	6	7	8
seeeeeee	eeeemmmm	mmmmmmmm	mmmmmmmm	mmmmmmmm	mmmmmmmm	mmmmmmmm	mmmmmmmm
MSB	MSB						

s: Sign of mantissa                      0: positive, 1: negative  
 e: Exponent part (11bit)                exp: 0 to 2,047  
 m: Mantissa (52bit)                      mantissa

Numeric value =  $(-1)^s \times 2^{(\text{exp}-1023)} \times (\underline{1} + \text{mantissa}/2^{52})$   
 However, when exp is 0, the underlined 1 is omitted

● IEEE single-precision floating point format in normal byte order (4bytes per data)

Transfer order

1	2	3	4
seeeeeee	emmmmmmm	mmmmmmmm	mmmmmmmm
MSB	MSB		

s: Sign of mantissa                      0: positive, 1: negative  
 e: Exponent part (8bit)                exp: 0 to 255  
 m: Mantissa (23bit)                      mantissa

Numeric value =  $(-1)^s \times 2^{(\text{exp}-127)} \times (\underline{1} + \text{mantissa}/2^{23})$   
 However, when exp is 0, the underlined 1 is omitted

● IEEE double-precision floating point format in reverse byte order

● IEEE single-precision floating point format in reverse byte order

Any of these formats is identical to the corresponding IEEE double-precision or single-precision floating-point format in normal byte order, except that the order of bytes to be transferred is reverse.

### 3.3 Program Code List

### 3.3 Program Code List

In a keyword string in headers or parameters that are used with the FRA5097, any number of characters that come before the final character can be omitted, except for some characters at the head of the string that may not be omitted. In the following description, characters that cannot be omitted will be represented in uppercase, and those which can be omitted will be represented in lowercase. A fully spelled header etc. makes the corresponding program code easier to understand, while an abbreviated one allows the controller resources or the transfer rate of a program code to be improved.

The main headers used in the FRA5097 program code are indicated in Table 3-1 Main Header List.

**Table 3-1 Main Header List**

Function	Main header	Action & setup range
Arithmetic calculation control	<b>CA</b> lculatIon	Arithmetic calculation, differentiation & integration, open-to-close loop conversion
Amplitude compression setup	<b>CO</b> mpression	A range of parameters for amplitude compression control
Data processing	<b>DA</b> tA	Tag switching, data navigation, display switching, data exchange to/from controller, format
Display control	<b>DI</b> splay	Analysis mode, graph display control, display range, marker
File processing	<b>FI</b> le	USB flash drive, mass memory, permanent memory, file list, deletion, rename
Input part control	<b>IN</b> put	Overload detection setup, equalization, weighting etc.
Measurement control	<b>ME</b> asure	Integration control, delay control, measurement mode, harmonics etc.
Oscillator control	<b>OS</b> cillator	Oscillator control, such as frequencies, amplitudes, offset, phases and waveforms, ON/OFF
Setup proces-sing of varied types	<b>SE</b> tup	Setups of calibration, clock, initialization, buzzer, etc.
Sweep control	<b>SW</b> EEP	Setups of sweep mode, max/min, resolution etc.
Others	Depends on the program code	SRQ mask, status byte, error, overload detection check etc.

In actuality, program codes are case-independent, so any of the following representations can be substituted for the oscillator control header "OScillator":

- os
- oSill
- oscillator

### 3.3 Program Code List

#### 3.3.1 Setup Message List

Table 3-2 Setup Message List (contd.)

Function	Header	Ref. page	Query
Run messages for arithmetic calculations on data			
Arithmetic calculation	<b>CA</b> lculati <b>o</b> n <b>AR</b> ithmetic	3-20	Present
Differentiation/integration	<b>CA</b> lculati <b>o</b> n <b>J</b> w	3-22	Present
Open-to-close loop conversion	<b>CA</b> lculati <b>o</b> n <b>L</b> oop	3-24	Present
Setup messages for amplitude compression control			
Reference amplitude level	<b>CO</b> mpressi <b>o</b> n <b>A</b> mplitud <b>e</b>	3-26	Present
Amplitude correction factor	<b>CO</b> mpressi <b>o</b> n <b>C</b> orrecti <b>o</b> n	3-27	Present
Maximum error rate of reference amplitude	<b>CO</b> mpressi <b>o</b> n <b>E</b> rr <b>o</b> r	3-28	Present
Output amplitude limitation	<b>CO</b> mpressi <b>o</b> n <b>L</b> imit	3-29	Present
Amplitude compression mode	<b>CO</b> mpressi <b>o</b> n mode	3-30	Present
Maximum retry times of correction	<b>CO</b> mpressi <b>o</b> n <b>R</b> etry	3-31	Present
Setup messages for data control			
Tag-number switching	<b>DA</b> ta <b>C</b> Urr <b>e</b> nt	3-32	Present
Display data switching	<b>DA</b> ta <b>D</b> isplay	3-33	Present
Entry of equalization data	<b>DA</b> ta <b>E</b> qualiz <b>e</b>	3-34	Absent
Register in open equalizer memory	<b>DA</b> ta <b>O</b> pen	3-35	Absent
Register in short equalizer memory	<b>DA</b> ta <b>S</b> hort	3-43	Absent
Data transfer format	<b>DA</b> ta <b>T</b> emplat <b>e</b>	3-44	Present
Data transfer from controller	<b>DA</b> ta <b>W</b> rite data	3-46	Absent
Transfer of general character strings from controller	<b>DA</b> ta <b>W</b> rite <b>T</b> itle	3-47	Absent
Setup messages for display control			
Analysis mode	<b>DI</b> splay <b>AN</b> alysis	3-48	Present
Autoscale	<b>DI</b> splay <b>AU</b> to	3-49	Present
Grid ON/OFF	<b>DI</b> splay <b>G</b> rid mode	3-50	Present
Grid type	<b>DI</b> splay <b>G</b> rid <b>T</b> ype	3-51	Present
Grid mode	<b>DI</b> splay <b>G</b> rid <b>S</b> tyle	3-52	Present
Setup of active marker	<b>DI</b> splay <b>MA</b> rker <b>A</b> ctive	3-54	Present
Setup of delta marker mode	<b>DI</b> splay <b>MA</b> rker mode	3-55	Present
Graph display mode	<b>DI</b> splay mode	3-56	Present
Phase display range	<b>DI</b> splay <b>P</b> hase	3-60	Present
Display scale (X axis)	<b>DI</b> splay <b>S</b> cale <b>X</b> axis	3-61	Present
Display scale (Y <sub>-1</sub> axis)	<b>DI</b> splay <b>S</b> cale <b>Y1</b> axis	3-62	Present
Display scale (Y <sub>-2</sub> axis)	<b>DI</b> splay <b>S</b> cale <b>Y2</b> axis	3-63	Present
Display units setting	<b>DI</b> splay <b>U</b> nits	3-64	Present
Graph display window mode	<b>DI</b> splay <b>W</b> indow	3-65	Present

### 3.3 Program Code List

**Table 3-2 Setup Message List (contd.)**

Function	Header	Ref. page	Query
Setup messages for file control			
Deletion of files	<b>File DElete Disk</b>	3-66	Absent
Deletion of mass memory	<b>File DElete Mass</b>	3-67	Absent
Deletion of permanent memory	<b>File DElete Permanent</b>	3-68	Absent
Loading data from USB flash drive	<b>File Load Disk data</b>	3-72	Absent
Loading setup conditions from USB flash drive	<b>File Load Disk Condition</b>	3-73	Absent
Loading from mass memory	<b>File Load Mass</b>	3-74	Absent
Loading from permanent memory	<b>File Load Permanent</b>	3-75	Absent
Rename of file	<b>File Rename Disk</b>	3-76	Absent
Saving data to file	<b>File Save Disk data</b>	3-77	Absent
Saving setup conditions to file	<b>File Save Disk Condition</b>	3-78	Absent
Storage to mass memory	<b>File Save Mass</b>	3-79	Absent
Storage to permanent memory	<b>File Save Permanent</b>	3-80	Absent
Setup messages for input part control			
Action for overload input	<b>INput Action</b>	3-81	Present
Arithmetic calculation for input (weighing)	<b>INput CAalculate</b>	3-82	Present
Input equalization	<b>INput Equalize</b>	3-83	Present
Open equalizer setting	<b>INput Open</b>	3-84	Present
Detection level for overload input	<b>INput OVer</b>	3-85	Present
Short function setting	<b>INput Short</b>	3-86	Present
Setup messages for measurement control			
Max cycles of automatic integration	<b>Measure Auto MAx Cycle</b>	3-87	Present
Max time of automatic integration	<b>Measure Auto MAx Sec</b>	3-88	Present
Type of max automatic integration	<b>Measure Auto MAx Type</b>	3-89	Present
Action of automatic integration	<b>Measure Auto mode</b>	3-90	Present
Coherence calculation mode	<b>Measure Coherence</b>	3-91	Present
Delay cycles for measurement start	<b>Measure Delay Cycle</b>	3-92	Present
Delay time for measurement start	<b>Measure Delay Sec</b>	3-93	Present
Delay type for measurement start	<b>Measure Delay Type</b>	3-94	Present
Order of harmonic analysis	<b>Measure Harmonic</b>	3-95	Present
Cycles of manual integration	<b>Measure Integration Cycle</b>	3-96	Present
Time of manual integration	<b>Measure Integration Sec</b>	3-97	Present
Type of manual integration	<b>Measure Integration Type</b>	3-98	Present
Measurement mode	<b>Measure Mode</b>	3-99	Present
Setup of Repeat Measure mode	<b>Measure Repeat</b>	3-100	Present



### 3.3 Program Code List

**Table 3-2 Setup Message List (contd.)**

Function	Header	Ref. page	Query
Setup messages for oscillator control			
Output amplitude	<b>OS</b> cillator <b>A</b> mplitude	3-101	Present
Frequency	<b>OS</b> cillator <b>F</b> requency	3-102	Present
Voltage change mode	<b>OS</b> cillator mode	3-103	Present
Output offset (DC bias)	<b>OS</b> cillator <b>OFF</b> Set	3-105	Present
Start/stop phase	<b>OS</b> cillator <b>P</b> hase	3-106	Present
Output waveform	<b>OS</b> cillator <b>W</b> aveform	3-107	Present
Setup messages of various types			
Buzzer ON/OFF	<b>SE</b> tup <b>B</b> uzzer	3-108	Present
Execution of calibration	<b>SE</b> tup <b>C</b> alibration	3-109	Absent
Date of clock	<b>SE</b> tup <b>D</b> ate	3-110	Present
GPIB header ON/OFF	<b>SE</b> tup <b>H</b> header	3-111	Present
Setup of initialization	<b>SE</b> tup <b>I</b> nitialize	3-112	Absent
Mnemonic ON/OFF	<b>SE</b> tup <b>M</b> nemonic	3-113	Present
Clock time	<b>SE</b> tup <b>T</b> ime	3-114	Present
Setup messages for sweep control			
Manual sweep	<b>SW</b> EEP <b>MA</b> nual	3-115	Present
Start/stop of sweep measurement	<b>SW</b> EEP <b>ME</b> asure	3-116	Present
Sweep range	<b>SW</b> EEP range	3-117	Present
Sweep resolution (Log steps/sweep)	<b>SW</b> EEP <b>RE</b> solution log sweep	3-118	Present
Sweep resolution (Log steps/decade)	<b>SW</b> EEP <b>RE</b> solution log <b>D</b> ecade	3-118	Present
Sweep resolution (Lin steps/sweep)	<b>SW</b> EEP <b>RE</b> solution <b>L</b> in sweep	3-120	Present
Sweep resolution (Hz)	<b>SW</b> EEP <b>RE</b> solution <b>L</b> in <b>H</b> z	3-121	Present
Type of sweep resolution	<b>SW</b> EEP <b>RE</b> solution <b>M</b> ode	3-122	Present
Operation mode of low-speed & high-density sweep	<b>SW</b> EEP <b>S</b> low mode	3-124	Present
Target channel for low-speed & high-density sweep	<b>SW</b> EEP <b>S</b> low <b>T</b> arget	3-125	Present
Target gain variation for low-speed & high-density sweep (dB)	<b>SW</b> EEP <b>S</b> low <b>V</b> ariation <b>L</b> ogr	3-126	Present
Target amplitude variation for low-speed & high-density sweep (Vrms)	<b>SW</b> EEP <b>S</b> low <b>V</b> ariation <b>R</b>	3-127	Present
Target phase variation for low-speed & high-density sweep (deg)	<b>SW</b> EEP <b>S</b> low <b>V</b> ariation <b>T</b> heta	3-128	Present
Target variation for real part of low-speed & high-density sweep (Vrms)	<b>SW</b> EEP <b>S</b> low <b>V</b> ariation <b>A</b>	3-129	Present
Target variation for imaginary part of low-speed & high-density sweep (Vrms)	<b>SW</b> EEP <b>S</b> low <b>V</b> ariation <b>B</b>	3-130	Present
Target variation type for low-speed & high-density sweep	<b>SW</b> EEP <b>S</b> low <b>V</b> ariation <b>M</b> ode	3-131	Present
List of other setup messages			
Enabling SRQ transmission	<b>SR</b> qenable	3-135	Present

### 3.3 Program Code List

#### 3.3.2 Query Message List

Table 3-3 Query Message List (contd.)

Function	Header	Ref. Page	Setup
Query messages for arithmetic calculations on data			
Arithmetic calculation	?CA $\mathbf{l}$ culat $\mathbf{i}$ on $\mathbf{A}$ rith $\mathbf{m}$ etic	3-20	Present
Differentiation/integration	?CA $\mathbf{l}$ culat $\mathbf{i}$ on $\mathbf{J}$ w	3-22	Present
Open-to-close loop conversion	?CA $\mathbf{l}$ culat $\mathbf{i}$ on $\mathbf{L}$ oop	3-24	Present
Query messages for amplitude compression control			
Reference amplitude level	?CO $\mathbf{m}$ press $\mathbf{i}$ on $\mathbf{A}$ mplit $\mathbf{u}$ de	3-26	Present
Amplitude correction factor	?CO $\mathbf{m}$ press $\mathbf{i}$ on $\mathbf{C}$ orrect $\mathbf{i}$ on	3-27	Present
Max error rate of reference amplitude	?CO $\mathbf{m}$ press $\mathbf{i}$ on $\mathbf{E}$ rror	3-28	Present
Output amplitude limitation	?CO $\mathbf{m}$ press $\mathbf{i}$ on $\mathbf{L}$ imit	3-29	Present
Amplitude compression mode	?CO $\mathbf{m}$ press $\mathbf{i}$ on $\mathbf{M}$ ode	3-30	Present
Max retry times of correction	?CO $\mathbf{m}$ press $\mathbf{i}$ on $\mathbf{R}$ etry	3-31	Present
Query messages for data control			
Tag-number switching	?DA $\mathbf{T}$ a $\mathbf{C}$ U $\mathbf{r}$ rent	3-32	Present
Display data switching	?DA $\mathbf{T}$ a $\mathbf{D}$ isplay	3-33	Present
Transfer of setup conditions to controller	?DA $\mathbf{T}$ a $\mathbf{R}$ ead $\mathbf{C}$ ON $\mathbf{D}$ ition	3-36	Absent
Data transfer to controller	?DA $\mathbf{T}$ a $\mathbf{R}$ ead $\mathbf{C}$ U $\mathbf{r}$ rent	3-39	Absent
Transfer of tag data to controller	?DA $\mathbf{T}$ a $\mathbf{R}$ ead $\mathbf{d}$ ata	3-40	Absent
Block count of tag data	?DA $\mathbf{T}$ a $\mathbf{R}$ ead $\mathbf{S}$ ize	3-41	Absent
Title of tag data	?DA $\mathbf{T}$ a $\mathbf{R}$ ead $\mathbf{T}$ itle	3-42	Absent
Data transfer format	?DA $\mathbf{T}$ a $\mathbf{T}$ emplate	3-44	Present
Query messages for display control			
Analysis mode	?DI $\mathbf{s}$ play $\mathbf{A}$ N $\mathbf{A}$ lysis	3-48	Present
Autoscale	?DI $\mathbf{s}$ play $\mathbf{A}$ U $\mathbf{T}$ o	3-49	Present
Grid ON/OFF	?DI $\mathbf{s}$ play $\mathbf{G}$ rid $\mathbf{m}$ ode	3-50	Present
Grid type	?DI $\mathbf{s}$ play $\mathbf{G}$ rid $\mathbf{T}$ ype	3-51	Present
Grid mode	?DI $\mathbf{s}$ play $\mathbf{G}$ rid $\mathbf{S}$ tyle	3-52	Present
Setup of active marker	?DI $\mathbf{s}$ play $\mathbf{M}$ A $\mathbf{R}$ ker $\mathbf{A}$ ctive	3-54	Present
Setup of delta marker mode	?DI $\mathbf{s}$ play $\mathbf{M}$ A $\mathbf{R}$ ker $\mathbf{m}$ ode	3-55	Present
Graph display mode	?DI $\mathbf{s}$ play $\mathbf{m}$ ode	3-56	Present
Phase display range	?DI $\mathbf{s}$ play $\mathbf{P}$ hase	3-60	Present
Display scale (X axis)	?DI $\mathbf{s}$ play $\mathbf{S}$ cale $\mathbf{X}$ axis	3-61	Present
Display scale (Y <sub>-1</sub> axis)	?DI $\mathbf{s}$ play $\mathbf{S}$ cale $\mathbf{Y}$ 1axis	3-62	Present
Display scale (Y <sub>-2</sub> axis)	?DI $\mathbf{s}$ play $\mathbf{S}$ cale $\mathbf{Y}$ 2axis	3-63	Present
Setup of Display Unit	?DI $\mathbf{s}$ play $\mathbf{U}$ nits	3-64	Present
Graph display window mode	?DI $\mathbf{s}$ play $\mathbf{W}$ indow	3-65	Present

### 3.3 Program Code List

**Table 3-3 Query Message List (contd.)**

Function	Header	Ref. page	Setup
Query messages for file control			
List of files	?File <b>Dir</b> <b>Disk</b>	3-69	Absent
Mass memory list	?File <b>Dir</b> <b>Mass</b>	3-70	Absent
Permanent memory list	?File <b>Dir</b> <b>Permanent</b>	3-71	Absent
Setup messages for input part control			
Action for overload input	?INput <b>Action</b>	3-81	Present
Arithmetic calculation for input (weighing)	?INput <b>CA</b> lculate	3-82	Present
Input equalization	?INput <b>E</b> qualize	3-83	Present
Open equalization	?INput <b>O</b> pen	3-84	Present
Detection level for overload input	?INput <b>O</b> ver	3-85	Present
Short equalization	?INput <b>S</b> hort	3-86	Present
Setup messages for measurement control			
Max cycles of automatic integration	?Measure <b>Auto</b> <b>MA</b> x <b>C</b> ycle	3-87	Present
Max time of automatic integration	?Measure <b>Auto</b> <b>MA</b> x <b>S</b> ec	3-88	Present
Type of max automatic integration	?Measure <b>Auto</b> <b>MA</b> x <b>T</b> ype	3-89	Present
Action of automatic integration	?Measure <b>Auto</b> mode	3-90	Present
Coherence calculation mode	?Measure <b>C</b> oherence	3-91	Present
Delay cycles for measurement start	?Measure <b>Delay</b> <b>C</b> ycle	3-92	Present
Delay time for measurement start	?Measure <b>Delay</b> <b>S</b> ec	3-93	Present
Delay type for measurement start	?Measure <b>Delay</b> <b>T</b> ype	3-94	Present
Order of harmonic analysis	?Measure <b>H</b> armonic	3-95	Present
Cycles of manual integration	?Measure <b>I</b> ntegration <b>C</b> ycle	3-96	Present
Time of manual integration	?Measure <b>I</b> ntegration <b>S</b> ec	3-97	Present
Type of manual integration	?Measure <b>I</b> ntegration <b>T</b> ype	3-98	Present
Measurement mode	?Measure <b>M</b> ode	3-99	Present
Setup of Repeat Measure mode	?Measure <b>R</b> epeat	3-100	Present
Query messages for oscillator control			
Output amplitude	?O <b>S</b> cillator <b>A</b> mplitude	3-101	Present
Frequency	?O <b>S</b> cillator <b>F</b> requency	3-102	Present
Voltage reset mode	?O <b>S</b> cillator mode	3-103	Present
Output offset (DC bias)	?O <b>S</b> cillator <b>O</b> FFSet	3-105	Present
Start/stop phase	?O <b>S</b> cillator <b>P</b> hase	3-106	Present
Output waveform	?O <b>S</b> cillator <b>W</b> aveform	3-107	Present

### 3.3 Program Code List

**Table 3-3 Query Message List (contd.)**

Function	Header	Ref. page	Setup
Query messages of various types			
Buzzer ON/OFF	?SEtup <b>B</b> uzzer	3-108	Present
Date of clock	?SEtup <b>D</b> ate	3-110	Present
GPIB header ON/OFF	?SEtup <b>H</b> header	3-111	Present
Mnemonic ON/OFF	?SEtup <b>M</b> nemonic	3-113	Present
Clock time	?SEtup <b>T</b> ime	3-114	Present
Query messages for sweep control			
Manual sweep	?SWEEP <b>M</b> ANual	3-115	Present
Start/stop of sweep measurement	?SWEEP <b>M</b> Easure	3-116	Present
Sweep range	?SWEEP <b>R</b> ange	3-117	Present
Sweep resolution (Log steps/sweep)	?SWEEP <b>R</b> ESolution log sweep	3-118	Present
Sweep resolution (Log steps/decade)	?SWEEP <b>R</b> ESolution log <b>D</b> ecade	3-118	Present
Sweep resolution (Lin steps/sweep)	?SWEEP <b>R</b> ESolution <b>L</b> in sweep	3-120	Present
Sweep resolution (Hz)	?SWEEP <b>R</b> ESolution <b>L</b> in Hz	3-121	Present
Type of sweep resolution	?SWEEP <b>R</b> ESolution <b>M</b> ode	3-122	Present
Operation mode of low-speed & high-density sweep	?SWEEP <b>S</b> low mode	3-124	Present
Target channel for low-speed & high-density sweep	?SWEEP <b>S</b> low <b>T</b> arget	3-125	Present
Target gain variation for low-speed & high-density sweep (dB)	?SWEEP <b>S</b> low <b>V</b> ariation <b>L</b> ogr	3-126	Present
Target amplitude variation for low-speed & high-density sweep (Vrms)	?SWEEP <b>S</b> low <b>V</b> ariation <b>R</b>	3-127	Present
Target phase variation for low-speed & high-density sweep (deg)	?SWEEP <b>S</b> low <b>V</b> ariation <b>T</b> heta	3-128	Present
Target variation for real part of low-speed & high-density sweep (Vrms)	?SWEEP <b>S</b> low <b>V</b> ariation <b>A</b>	3-129	Present
Target variation for imaginary part of low-speed & high-density sweep (Vrms)	?SWEEP <b>S</b> low <b>V</b> ariation <b>B</b>	3-130	Present
Target variation type for low-speed & high-density sweep	?SWEEP <b>S</b> low <b>V</b> ariation <b>M</b> ode	3-131	Present
List of other query messages			
Error code	?E <b>R</b> ror	3-132	Absent
Model identification code	?I <b>D</b> entifier	3-133	Absent
Results of overload detection	?O <b>V</b> erload	3-134	Absent
Enabling SRQ transmission	?S <b>R</b> qenable	3-135	Present
Status byte	?S <b>T</b> atus	3-136	Absent
Software version	?V <b>E</b> rsion	3-137	Absent
Reading of all setup conditions	?L <b>E</b> arn	3-138	Absent

#### **3.4 Individual program code description**

In paragraph 3.4, the program codes of the GPIB/USB will be detailed.

The lowercase part of each program code can be omitted.

The underlined part of an answer to a query message is a header that is output only when "SEtup Header" is set to 1 or ON.

■ **CA**lculat**ion** **A**rith**metic**

?**CA**lculat**ion** **A**rith**metic**

Setup: **CA**lculat**ion** **A**rith**metic** <param1>, <param2>, <param3>, <param4>, <param5>, <param6>

Query: ?**CA**lculat**ion** **A**rith**metic**

(Answer) CALCULATION ARITHMETIC <param1>, <param2>, <param3>, <param4>, <param5>, <param6>

- General: Sets or inquires the function of arithmetic calculation

- Parameter (when parameters are set)

- param1: Type of target data 1 for arithmetic calculation
- param4: Type of target data 2 for arithmetic calculation

Format: NR1 or string

NR1	String	Description
0	<b>T</b> ag	Tag data
1	<b>C</b> onstant	Real constant
2	<b>J</b>	Imaginary constant
	Omit	None changes

- param2: Value of target data 1 for arithmetic calculation
  - param5: Value of target data 2 for arithmetic calculation
- Format: NR1 (when target data type for calculation is tag data)  
 Range: 0, 1 to 6 (0 indicates the tag currently displayed)  
 NR3 (when target data type for calculation is a (real or imaginary) constant)  
 Range: -99.99E+6 to +99.99E+6  
 Resolution: 0.001E-06
- Omit: None changes
- param3: Arithmetic calculation mode
- Format: NR1 or string

NR1	String	Description
0	<b>A</b> dd	Addition (param2) + (param5) = (param6)
1	<b>S</b> ubtract	Subtraction (param2) – (param5) = (param6)
2	<b>M</b> ultipl <b>y</b>	Multiplication (param2) x (param5) = (param6)
3	<b>D</b> ivide	Division (param2) ÷ (param5) = (param6)
	Omit	None changes

### 3.4 Individual program code description

- param6: Tag number to which calculation result is stored  
Format: NR1  
Range: 0, 1 to 6 (0 indicates the tag currently displayed)  
Omit: None changes
- Answer message (when a query is run)
  - param1: Current type of target data 1 for arithmetic calculation
  - param4: Current type of target data 2 for arithmetic calculation  
Format: NR1 (characters: 2) or string (to be set by **SE**tup **M**nemonic)

Answer format		Description
NR1	String	
0	TAG	Target data is tags
1	CONSTANT	Target data is real constants
2	J	Target data is imaginary constants

  - param2: Current value of target data 1 for arithmetic calculation
  - param5: Current value of target data 2 for arithmetic calculation  
Format: NR1 (when target data type for calculation is tag data)  
Range: 0, 1 to 6 (0 indicates the tag currently displayed)  
Characters: 2  
NR3 (when target data type for calculation is a (real or imaginary) constant)  
Range: -99.99E+6 to +99.99E+6  
Characters: 10
  - param3: Arithmetic calculation mode  
Format: NR1 (characters: 2) or string (to be set by **SE**tup **M**nemonic)

Answer format		Description
NR1	String	
0	ADD	Addition
1	SUBSTRACT	Subtraction
2	MULTIPLY	Multiplication
3	DIVIDE	Division

  - param6: Tag number to which calculation result is stored  
Format: NR1  
Range: 0, 1 to 6 (0 indicates the tag currently displayed)  
Characters: 2
  - Example setup  
cal a 0,0,2,1,10,0    Multiplies the data currently displayed by 10

■ **CA**lcalulation Jw

?**CA**lcalulation Jw

Setup: **CA**lcalulation Jw <param1>, <param2>, <param3>

Query: ?**CA**lcalulation Jw

(Answer) CALCULATION JW <param1>, <param2>, <param3>

- General: Sets or inquires the function of differential and integral operation

- Parameter (when parameters are set)

- param1: Type of arithmetic calculation

Format: NR1

param1	Description
-2	Double integration
-1	Integration
1	Differentiation
2	Second order differentiation
(Omit)	None changes

- param2: Tag number of target data for arithmetic calculation

Format: NR1

Range: 0, 1 to 6 (0 indicates the tag currently displayed)

Omit: None changes

- param3: Tag number to which calculation result is stored

Format: NR1

Range: 0, 1 to 6 (0 indicates the tag currently displayed)

Omit: None changes



### 3.4 Individual program code description

---

- Answer message (when a query is run)

- param1: Current type of arithmetic calculation

Format: NR1

param1	Description
-2	Double integration
-1	Integration
1	Differentiation
2	Second order differentiation

- param2: Current tag number of target data for arithmetic calculation

Format: NR1

Range: 0, 1 to 6 (0 indicates the tag currently displayed)

Characters: 2

- param3: Tag number to which current calculation result is stored

Format: NR1

Range: 0, 1 to 6 (0 indicates the tag currently displayed)

Characters: 2

- Example setup

cal jw -2,1,2

Double-integrates tag 1 data and store the result to tag 2

## ■ CA Calculation Loop

### ?CA Calculation Loop

Setup: **CA** Calculation Loop <param1>, <param2>, <param3>, <param4>, <param5>

Query: **?CA** Calculation Loop

(Answer) CALCULATION LOOP <param1>, <param2>, <param3>, <param4>, <param5>

- General: Sets or inquires the function of open-to-close loop calculation

- Parameter (when parameters are set)

- param1: Tag number of target data for arithmetic calculation

Format: NR1

Range: 0, 1 to 6 (0 indicates the tag currently displayed)

Omit: None changes

- param2: Type of feedback element data Tm

Format: NR1 or string

NR1	String	Description
0	Tag	Tag data
1	Constant	Real constant
	Omit	None changes

- param3: Value of feedback element data Tm

Format: NR1 (when target data type for calculation is tag data)

Range: 0, 1 to 6 (0 indicates the tag currently displayed)

NR3 (when target data type for calculation is a constant)

Range: -099.99E+6 to +99.99E+6

Resolution: 0.001E-6

- param4: Arithmetic calculation mode

Format: NR1 or string

NR1	String	Description
0	Close	Open→close loop conversion
1	Open	Close→open loop conversion
	Omit	None changes

- param5: Tag number to which calculation result is stored

Format: NR1

Range: 0, 1 to 60 (0 indicates the tag currently displayed)

### 3.4 Individual program code description

- Answer message (when a query is run)

- param1: Current tag number of target data for arithmetic calculation

Format: NR1

Range: 0, 1 to 6 (0 indicates the tag currently displayed)

Characters: 2

- param2: Current type of feedback element data Tm

Format: NR1 (characters: 2) or string (to be set by **SE**up **M**nemonic)

Answer format		Description
NR1	String	
0	TAG	Target data is tags
1	CONSTANT	Target data is real constants

- param3: Current value of feedback element data Tm

Format: NR1 (when feedback element data is tag data)

Range: 0, 1 to 6 (0 indicates the tag currently displayed)

Characters: 2

NR3 (when feedback element data is real constants)

Range: -99.99E+6 to +99.99E+6

Characters: 10

- param4: Current mode of arithmetic calculation

Format: NR1 (characters: 2) or string (to be set by **SE**up **M**nemonic)

Answer format		Description
NR1	String	
0	CLOSE	Open→close loop conversion
1	OPEN	Close→open loop conversion

- param5: Tag number to which current calculation result is stored

Format: NR1

Range: 0, 1 to 6 (0 indicates the tag currently displayed)

Characters: 2

- Example setup

cal loop 1, 0, 2, 1, 3

Determines the open loop property and stores it to tag 3 when the property data of close loop is in tag 1 and the property data of feedback element Tm is in tag 2

## ■ **CO**mpression **A**mplitude

### ?**CO**mpression **A**mplitude

Setup: **CO**mpression **A**mplitude <param>

Query: ?**CO**mpression **A**mplitude

(Answer) COMPRESSION AMPLITUDE <param>

- General: Sets or inquires the reference amplitude level for amplitude compression
  
- Parameter (when parameters are set)
  - param: Reference amplitude level
    - Format: NR3
    - Range: 1E-3 to 250(1 mVrms to 250 Vrms)
    - Resolution: 3 digits
  
- Answer message (when a query is run)
  - param: Current level of reference amplitude
    - Format: NR3
    - Range: 1.00E-03 to 250E+00(1 mVrms to 250 Vrms)
    - Characters: 9
  
- Example setup  
compression amplitude 7.07e1      Reference amplitude level: 70.7 Vrms
  
- Related program codes  
COmpression Correction, COmpression Error, COmpression Limit,  
COmpression mode, COmpression Retry

## ■ **CO**mpression **CO**rrrection

### ?**CO**mpression **CO**rrrection

Setup: **CO**mpression **CO**rrrection <param>

Query: ?**CO**mpression **CO**rrrection

(Answer) COMPRESSION CORRECTION <param>

- General: Sets or inquires the amplitude correction factor for amplitude compression
  
- Parameter (when parameters are set)
  - param: Amplitude correction factor
    - Format: NR1
    - Range: 0 to 100 (%)
    - Resolution: 1 (%)
  
- Answer message (when a query is run)
  - param: Current amplitude correction factor
    - Format: NR1
    - Range: 0 to 100 (%)
    - Characters: 4
  
- Example setup  
compression correction 70                      Amplitude correction factor: 70%
  
- Related program codes  
COmpression Amplitude, COmpression Error, COmpression Limit,  
COmpression mode, COmpression Retry

## ■ **CO**mpression **E**rror

### ?**CO**mpression **E**rror

Setup: **CO**mpression **E**rror <param>

Query: ?**CO**mpression **E**rror

(Answer) COMPRESSION\_ERROR <param>

- General: Sets or inquires the maximum error rate for amplitude compression

- Parameter (when parameters are set)

- param: Maximum error rate
  - Format: NR1
  - Range: 0 to 100 (%)
  - Resolution: 1 (%)

- Answer message (when a query is run)

- param: Current maximum error rate
  - Format: NR1
  - Range: 0 to 100 (%)
  - Characters: 4

- Example setup

compression error 1

Maximum error rate: 1%

- Related program codes

COmpression Amplitude, COmpression Correction, COmpression Limit,  
COmpression mode, COmpression Retry

## ■ **CO**mpression Limit

### ?**CO**mpression Limit

Setup: **CO**mpression Limit <param>

Query: ?**CO**mpression Limit

(Answer) COMPRESSION LIMIT <param>

- General: Sets or inquires the output amplitude limitation for amplitude compression
  
- Parameter (when parameters are set)
  - param: Maximum amplitude (output open conversion)  
Format: NR3  
Range: 1E-3 to 10.0 (Vpeak)  
Resolution: Up to 3 digits, 10  $\mu$  V
  
- Answer message (when a query is run)
  - param: Current maximum amplitude (output open conversion)  
Format: NR3  
Range: 1.00E-03 to 10.0E+00 (Vpeak)  
Characters: 9
  
- Example setup  
compression limit 1.2                      Maximum output amplitude: 1.2 Vpeak
  
- Related program codes  
COmpression Amplitude, COmpression Correction, COmpression Error,  
COmpression mode, COmpression Retry

## ■ **CO**mpression mode

### ?**CO**mpression mode

Setup: **CO**mpression mode <param>

Query: ?**CO**mpression mode

(Answer) COMPRESSION MODE <param>

- General: Sets or inquires the operation mode of amplitude compression
- Parameter (when parameters are set)
  - param: Operation mode of amplitude compression
  - Format: NR1 or string

NR1	String	Description
0	<b>OFF</b>	Amplitude compression OFF
1	<b>CH1</b>	Amplitude compression ON, Reference input: CH1
2	<b>CH2</b>	Amplitude compression ON, Reference input: CH2
Omit		None changes

- Answer message (when a query is run)
  - param: Current operation mode of amplitude compression
  - Format: NR1 (characters: 2) or string (to be set by **SE**tup **M**nemonic)

Answer format		Description
NR1	String	
0	OFF	Amplitude compression OFF
1	CH1	Amplitude compression ON, Reference input: CH1
2	CH2	Amplitude compression ON, Reference input: CH2

- Example setup
 

compression mode ch1	Amplitude compression ON with ch1 as the reference input
----------------------	--
- Related program codes
 

COmpression Amplitude, COmpression Correction, COmpression Error, COmpression Limit, COmpression Retry



## ■ **CO**mpression Retry

### ?**CO**mpression Retry

Setup: **CO**mpression Retry <param>

Query: ?**CO**mpression Retry

(Answer) COMPRESSION\_RETRY <param>

- General: Sets or inquires the maximum retry times of correction for amplitude compression
  
- Parameter (when parameters are set)
  - param: Maximum retry times of correction  
Format: NR1  
Range: 1 to 9999 (times)  
Resolution: 1
  
- Answer message (when a query is run)
  - param: Current maximum retry times of correction  
Format: NR1  
Range: 1 to 9999 (times)  
Characters: 5
  
- Example setup  
compression retry 100                      Maximum retry times of correction: 100
  
- Related program codes  
COmpression Amplitude, COmpression Correction, COmpression Error,  
COmpression Limit, COmpression mode

## ■ **DA**tA **CU**rrent

### ?**DA**tA **CU**rrent

Setup: **DA**tA **CU**rrent <param>

Query: ?**DA**tA **CU**rrent

(Answer) DATA CURRENT <param>

- General: Sets or inquires the current tag number
  
- Parameter (when parameters are set)
  - param: Tag number to be defined as the current tag number  
Format: NR1  
Range: 1 to 6
  
- Answer message (when a query is run)
  - param: Current current tag number  
Format: NR1  
Range: 1 to 6  
Characters: 2
  
- Example setup

data current 2	Defines and displays tag 2 as the current tag number
----------------	--
  
- Remarks

The current tag indicates the one that is currently active. It refers to the tag number that is used when tag number 0 is specified in arithmetic calculation, etc.

The following will result if a tag is specified as a current tag when a graph is shown in SPLIT view mode ("Display Window SPLIT"):

  - When the specified tag number matches the tag number of either the upper or lower graph, the graph will become active.
  - When the specified tag number is not currently displayed, the data of that number will be assigned to either the upper or lower graph which is currently active.
  
- Related program codes

Display Window , DAta Display

## ■ **DA**ta Display

### ?**DA**ta Display

Setup: **DA**ta Display <param1>, <param2>

Query: ?**DA**ta Display

(Answer) DATA DISPLAY <param1>, <param2>

- General: Sets or inquires the tag number to be displayed
  
- Parameter (when parameters are set)
  - param1: Tag number to be displayed. In SPLIT view mode, this is the tag number that is displayed in the upper graph.
    - Format: NR1
    - Range: 1 to 6
    - Omit: None changes
  - param2: In SPLIT view mode, this is the tag number that is displayed in the lower graph. This will be disabled in SINGLE view mode. If 0 is specified, then the lower graph will not be changed.
    - Format: NR1
    - Range: 0 to 6
    - Omit: None changes
  
- Answer message (when a query is run)
  - param1: Tag number that is currently being displayed (in SPLIT view mode, the tag number in the upper graph)
    - Format: NR1
    - Range: 1 to 6
    - Characters: 2
  - param2: Tag number that is displayed in the lower graph (in SPLIT view mode). Constantly 0 in SINGLE view mode
    - Format: NR1
    - Range: 1 to 6
    - Characters: 2
  
- Example setup
 

data display 1,2	Displays tag 1 and tag 2 respectively in the upper and lower graphs (in SPLIT mode)
------------------	---
  
- Related program codes
  - Display Window, **DA**ta **C**urrent

#### ■ Data Equalize

Setup: Data Equalize <param>

- General: Registers with equalize memory
- Parameter (when parameters are set)
  - param: Tag number of data to be registered with equalize memory  
Format: NR1  
Range: 1 to 6
- Example setup  
data equalize 1                      Registers tag 1 data with equalize memory
- Remarks  
After the data has been registered with equalize memory, the equalize function will be enabled by means of "INput Equalize ON"
- Related program code  
INput Equalize

### ■ DAta Open

Setup: DAta Open <param>

- General: Register in open equalizer memory

- Parameter (when setting)

- param: Tag number for registry in open equalizer memory

Format: NR1

Range: 1 to 6

- Example setup

data open 1

Register tag 1 data in open equalizer memory

- Remarks

After registering, the open equalizer is effective by INput Open ON.

- Related program code

INput Open

## ■ ?DATA Read COndition

Query: ?DATA Read COndition <param>

(Answer)

### DATA READ CONDITION

<param1>, <param2>, <param3> (block delimiter)  
 <param4> (block delimiter)  
 <param5>, <param6>, <param7> (block delimiter)  
 <param8>, <param9>, <param10>, <param11> (block delimiter)  
 <param12>, <param13> (block delimiter)  
 <param14>, <param15> (block delimiter)  
 <param16>,<param17>,<param18>,<param19>,<param20> (record delimiter)

- General: Inquires the measurement conditions for specified tag data
- Parameter (when a query is run)
  - param: Tag number to which measurement conditions will be transferred
    - Format: NR1
    - Range: 1 to 6
    - Omit: Current tag number
- Answer message
  - param1: Data type
    - Format: NR1 (characters: 2) or string (to be set by **SE**tup **M**nemonic)

Answer format		Description
NR1	String	
0	RAW	Measurement data
1	OPRD	Operated data

  - param2: Data count
    - Format: NR1
    - Range: Up to (Data count of specified tag)
    - Characters: 6
  - param3: Date and time when a measurement was carried out
    - Format: YYYY-MM-DD, HH-MM-SS (year-month-day, hour-minute-second)
    - SS is constantly 00

### 3.4 Individual program code description

- param4: Title of data  
Format: A character string is enclosed with double quotation codes ("").  
Refer to "**3.1.3 b) Parameters in string format**".
- param5: Oscillator amplitude (V<sub>peak</sub>)  
Format: NR3, 9 characters
- param6: Oscillator, DC bias (V)  
Format: NR3, 10 characters
- param7: Oscillator waveform  
Format: NR1 or string Refer to "OScillator Waveform".
- param8: Maximum sweep frequency (Hz)  
Format: NR3, 17 characters
- param9: Minimum sweep frequency (Hz)  
Format: NR3, 17 characters
- param10: Sweep type  
Format: NR1 or string Refer to "SWEEP REsolution Mode".
- param11: Sweep resolution  
Format: NR1 or string Refer to "SWEEP REsolution \*\*\*\*".
- param12: Integration type  
Format: NR1 or string Refer to "Measure Integration Type".
- param13: Integration level  
Format: NR1 or NR3 Refer to "Measure Integration \*\*\*\*".
- param14: Delay type  
Format: NR1 or string Refer to "Measure Delay Type".
- param15: Delay level  
Format: NR1 or NR3 Refer to "Measure Delay \*\*\*\*".
- param16: Degree of harmonic analysis  
Format: NR1, 3 characters
- param17: Measurement mode  
Format: NR1 or string Refer to "Measure Mode".
- param18: Automatic integration function  
Format: NR1 (characters: 2) or string (to be set by **SE**up **M**nemonic)

Answer format		Description
NR1	String	
0	OFF	Manual integration
1	ON	Automatic integration

### 3.4 Individual program code description

- param19: Low-speed & high-density sweep function

Format: NR1 (characters: 2) or string (to be set by **SE**up **M**nemonic)

Answer format		Description
NR1	String	
0	OFF	Normal sweep
1	ON	Low-speed & high-density sweep

- param20: Amplitude compression function

Format: NR1 (characters: 2) or string (to be set by **SE**up **M**nemonic)

Answer format		Description
NR1	String	
0	OFF	Amplitude compression OFF
1	ON	Amplitude compression ON

- Example setup

?data read condition 1

Transfers the measurement conditions of tag data 1 to controller

- Remarks

When the data is of operated type (param1 is 0 or OPRD), the data between param5 and param20 is invalid.



#### ■ ?DAta Read CUrrent

Query: ?DAta Read CUrrent

(Answer) Measurement data

- General: Inquires the final data that was measured (block 1)
- Answer message (when a query is run)  
The format that was set by "DAta Template" will be used.
- Example setup  
?data read current                      Inquires the final data measured
- Remarks  
The transfer format etc. can be set by "DAta Template". No header is included.
- Related program code  
DAta Template

#### ■ ?DAta Read data

Query: ?DAta Read data <param1>, <param2>, <param3>

(Answer) (Tag data)

- General: Inquires a specified data range of a specified tag

- Parameter (when parameters are set)

- param1: Tag number to be inquired for data
  - Format: NR1
  - Range: 1 to 6
  - Omit: Current tag number
- param2: Block number of data from which reading is started
  - Format: NR1
  - Range: 0 to (block count of data to be read minus 1)
  - Omit: 0
- param3: Block count of data to be read
  - Format: NR1
  - Range: 1 to (block count of data to be read)
  - Omit: Block count of data to be read

- Answer message (when a query is run)

The format set by "DAta Template" will be used.

- Example setup

?data read data 2

Inquires all data of tag 2

- Remarks

The transfer format etc. can be set using "DAta Template" No header is included.

An error will result if an attempt is made to read the data of a tag for which a measurement is in progress (error code:43).

- Related program codes

DAta Template, ?DAta Read Size, DAta Write data

## ■ ?DAta Read Size

Query: ?DAta Read Size <param>

(Answer) DATA READ SIZE <param>

- General: Inquiries the data block count of a tag
  
- Parameter (when a query is run)
  - param: Tag number from which the data block count is read out
    - Format: NR1
    - Range: 1 to 6
    - Omit: Current tag number
  
- Answer message (when a query is run)
  - param: Block count of data in a specified tag
    - Format: NR1
    - Range: 1 to (block count of data in a specified tag)
    - Characters: 6
  
- Example setup
  - ?data read size 1    Inquires the block count of data in tag 1
  
- Related program code
  - ?DAta Read data

## ■ ?DAta Read Title

Query: ?DAta Read Title <param>

(Answer) DATAWRITE TITLE <param>

- General: Inquires the title string of a tag
  
- Parameter (when a query is run)
  - param: Tag number from which the title string is read out
  - Format: NR1
  - Range: 1 to 6
  - Omit: Current tag number
  
- Answer message (when a query is run)
  - param: Title string of data in a specified tag
  - Format: String
  
- Example setup
  - ?data read title 3                                  Inquires the title of tag 3
  
- Remarks
  - A null string ("") will be read out when there is no data in a specified tag.
  
- Related program code
  - DAta Write title

## ■ Data Short

Setup: **Data Short** <param>

- General: Register in short equalizer memory
- Parameter (when setting)
  - param: Tag number for registry in short equalizer memory  
Format: NR1  
Range: 1 to 6
- Example setup  
data short 1    Register tag 1 data in short equalizer memory
- Remarks  
After registering, the open equalizer is effective by INput Short ON.
- Related program code  
INput Short

## ■ Data Template

### ?Data Template

Setup: **Data Template** <param1>, <param2>,...

Query: **?Data Template**

(Answer) DATA TEMPLATE <param1>, <param2>,...

- General: Sets or inquires the data transfer format

- Parameter (when parameters are set)

- param1: Data format

Format: NR1 or string

NR1	String	Transfer format
0	<b>String</b>	ASCII format
1	<b>Double</b>	IEEE Double format
2	<b>Float</b>	IEEE Float format
3	<b>INVDouble</b>	IEEE Double format in reverse byte order
4	<b>INVFloat</b>	IEEE Float format in reverse byte order

- param2 or later: Configuration and sequence of transfer data in a single block

Format: NR1 or string

NR1	String	Description
1	<b>Sweep</b>	Frequency
2	<b>LOGR</b>	Amplitude (dBV) or gain (dB)
3	<b>R</b>	Amplitude (Vrms) or gain
4	<b>Theta</b>	Phase (deg)
5	<b>A</b>	Real part of amplitude (Vrms) or gain
6	<b>B</b>	Imaginary part of amplitude (Vrms) or gain

The sequence of the 2nd argument (param2) or later is optional. 6 arguments at maximum (up to param7).

### 3.4 Individual program code description

- Answer message (when a query is run)

- param1: Current data format

Format: NR1 (characters: 2) or string (to be set by SEtup Mnemonic)

Answer format		Description
NR1	String	
0	STRING	Character string
1	DOUBLE	IEEE Double
2	FLOAT	IEEE Float
3	INVDOUBLE	IEEE Double in reverse byte order
4	INVFLOAT	IEEE Float in reverse byte order

- param2 or later: Configuration and sequence of transfer data in a single block

Format: NR1 (characters: 2) or string (to be set by SEtup Mnemonic)

Answer format		Description
NR1	String	
1	SWEEP	Frequency
2	LOGR	Amplitude (dBV) or gain (dB)
3	R	Amplitude (Vrms) or gain
4	THETA	Phase (deg)
5	A	Real part of amplitude (Vrms) or gain
6	B	Imaginary part of amplitude (Vrms) or gain

- Example setup

data template string, sweep, logr, theta

Sets so that the string format data will be output in sequence of frequency - string - phase

- Remarks

The units for LOGR, R, A or B of param2 or later will depend on the current analysis mode (to be set by "Display ANalysis").

	Analysis mode	
	CH1/CH2 or CH2/CH1	CH1 or CH2
LOGR	dB	dBV
R	No unit (ratio)	Vrms
A, B	No unit (ratio)	Vrms

- Related program codes

?DAta Read CUrrent, ?DAta Read data, DAta Write data

#### ■ **DAta Write data**

Setup: **DAta Write data** <param1>, <param2>, <param3> (delimiter)(data)

- General: Writes data
  
- Parameter (when parameters are set)
  - param1: Tag number to which data is written
    - Format: NR1
    - Range: 1 to 6
    - Default: Current tag number
  - param2: Block number of data from which writing is started
    - Format: NR1
    - Range: 0 to 20000
  - param3: Block count of data to be written
    - Format: NR1
    - Range: 1 to 20001

- Example setup

data write data 2, 0, 101                      Writes 101 data starting at the head of tag 2

- Remarks

The transfer format etc. can be set by "DAta Template".

The total block count in a tag to which data has been written is: param2 + param3.

Any data following the block number specified in param2, will be not changed even after the data has been written. When the original tag is empty, any data that follows param2 will become 0.

If an EOI is received during the transfer of some data in binary format before the specified amount of data has arrived, then the tag data will not be changed.

- Related program codes

DAta Template, ?DAta Read Size, ?DAta Read data



#### ■ **DAta Write Title**

Setup: **DAta Write Title** <param1>, <param2>

- **General:** Writes the title string of a tag
  
- **Parameter (when parameters are set)**
  - **param1:** Tag number to which the title string is written  
Format: NR1  
Range: 1 to 6
  - **param2:** Title string  
Format: String, up to 63 characters

- **Example setup**

data write title 2,"DATA NO.5, GAIN:10dB"

- **Remarks**

When a space, comma or semicolon is contained in a title string, enclose it with double quotation codes (") or single quotation codes (,).

- **Related program code**

?DAta Read Title

## ■ Display ANalysis

### ?Display ANalysis

Setup: **D**isplay **A**Nalysis <param>

Query: **?D**isplay **A**Nalysis

(Answer) DISPLAY ANALYSIS <param>

- General: Sets or inquires the analysis mode of the tag data that is being displayed (active)

- Parameter (when parameters are set)

- param: Analysis mode

Format: NR1 or string

NR1	String	Description
0	<b>CH1B</b> ych2	Analysis mode: CH1/CH2
1	<b>CH2B</b> ych1	Analysis mode: CH2/CH1
2	<b>CH1</b>	Analysis mode: CH1
3	<b>CH2</b>	Analysis mode: CH2

- Answer message (when a query is run)

- param: Current analysis mode

Format: NR1 (characters: 2) or string (to be set by SEtup Mnemonic)

Answer format		Description
NR1	String	
0	CH1BYCH2	Analysis mode: CH1/CH2
1	CH2BYCH1	Analysis mode: CH2/CH1
2	CH1	Analysis mode: CH1
3	CH2	Analysis mode: CH2

- Example setup

display analysis ch1b

Sets the analysis mode of the currently shown tag to CH1/CH2

- Related program code

Display mode

## ■ Display Auto

### ?Display AUto

Setup: **D**isplay **AU**to <param>

Query: ?D**I**splay **AU**to

(Answer) DISPLAY AUTO <param>

- General: Sets or inquires autoscale ON/OFF

- Parameter (when parameters are set)

- param: Setting of autoscale

Format: NR1 or string

NR1	String	Description
0	<b>OFF</b>	Autoscale OFF
1	<b>ON</b>	Autoscale ON

- Answer message (when a query is run)

- param: Current setup conditions of autoscale

Format: NR1 (characters: 2) or string (to be set by SEtup Mnemonic)

Answer format		Description
NR1	String	
0	OFF	Autoscale OFF
1	ON	Autoscale ON

- Example setup

display auto on

Autoscale ON

- Related program codes

Display Scale Xaxis, Display Scale Y1axis, Display Scale Y2axis

## ■ Display Grid mode

### ?Display Grid mode

Setup: **D**isplay **G**rid mode <param>

Query: **?D**isplay **G**rid mode

(Answer) DISPLAY GRID MODE <param>

- General: Sets or inquires a grid display or no grid display

- Parameter (when parameters are set)

- param: Grid display/no grid display

Format: NR1 or string

NR1	String	Description
0	<b>OFF</b>	No grid displayed
1	<b>ON</b>	Grid displayed

- Answer message (when a query is run)

- param: Current grid display condition

Format: NR1 (characters: 2) or string (to be set by SEtup Mnemonic)

Answer format		Description
NR1	String	
0	<b>OFF</b>	No grid displayed
1	<b>ON</b>	Grid displayed

- Example setup

display grid on

Displays a grid

- Related program codes

Display Grid Type, Display Grid Style

## ■ Display Grid Type

### ?Display Grid Type

Setup: **D**isplay **G**rid Type <param>

Query: **?D**isplay **G**rid Type

(Answer) DISPLAY GRID TYPE <param>

- General: Sets or inquires the grid type

- Parameter (when parameters are set)

- param: Grid type

Format: NR1 or string

NR1	String	Description
0	<b>S</b> olid	Grid in solid line
1	<b>B</b> roken	Grid in broken line

- Answer message (when a query is run)

- param: Current grid type

Format: NR1 (characters: 2) or string (to be set by SEtup Mnemonic)

Answer format		Description
NR1	String	
0	<b>S</b> OLID	Grid in solid line
1	<b>B</b> ROKEN	Grid in broken line

- Example setup

display grid type 1

Sets a grid in broken line

- Related program codes

Display Grid mode, Display Grid Style

## ■ Display Grid Style

### ?Display Grid Style

Setup: **D**isplay **G**rid **S**tyle <param>

Query: **?D**isplay **G**rid **S**tyle

(Answer) DISPLAY GRID STYLE <param>

- General: Sets or inquires the grid mode

- Parameter (when parameters are set)

- param: Grid mode

Format: NR1 or string

NR1	String	Description
0	<b>X</b>	X axis only grid
1	<b>XY1</b>	X and Y1 axis grids
2	<b>XY2</b>	X and Y2 axis grids
3	<b>XY1Y2</b>	X, Y1 and Y2 axis grids

- The FRA5095 software version less than 1.99 character string designates the corresponding numerical value (NR1) for replacement.

NR1	String	Description
0	<b>F</b>	Frequency axis grid only
1	<b>FR</b>	Frequency and gain axis grids
2	<b>FTheta</b>	Frequency and phase axis grids
3	<b>FRTheata</b>	Frequency, gain and phase axis grids

- Answer message (when a query is run)

- param: Current grid mode

Format: NR1 (characters: 2) or string (to be set by SSetup Mnemonic)

Answer format		Description
NR1	String	
0	X	X axis grid only
1	XY1	X and Y1 axis grids
2	XY2	X and Y2 axis grids
3	XY1Y2	X, Y1 and Y2 axis grids

### 3.4 Individual program code description

---

- Example setup

display grid style XY1Y2

Displays a grid for X-Y1-Y2

- Remarks

This setup will be valid only when the graph is a Bode diagram (in which the horizontal axis is for frequency and the vertical axis for gain/amplitude/phase).

- Related program codes

Display Grid mode, Display Grid Type

## ■ Display MArker Active

### ?Display MArker Active

Setup: **D**isplay **M**Arker **A**ctive <param>

Query: **?D**isplay **M**Arker **A**ctive

(Answer) DISPLAY MARKER ACTIVE <param>

- General: Sets or inquires the active marker

- Parameter (when parameters are set)

- param: Setting of active marker

Format: NR1 or string

NR1	String	Description
0	Off	No marker displayed
1	Data	Data marker
2	Vertical	X-axis line marker
3	Horizontal	Y-axis line marker

- Answer message (when a query is run)

- param: Current active marker

Format: NR1 (characters: 2) or string (to be set by **SE**tup **M**nemonic)

Answer format		Description
NR1	String	
0	OFF	No marker displayed
1	DATA	Data marker
2	VERTICAL	X-axis line marker
3	HORIZONTAL	Y-axis line marker

- Example setup

display ma a DATA

Displays a data marker, Sets to active

- Related program code

Display MArker mode



■ **D**isplay **M**Arker mode

?**D**isplay **M**Arker mode

Setup: **D**isplay **M**Arker mode <param>

Query: ?**D**isplay **M**Arker mode

(Answer) DISPLAY MARKER MODE <param>

- General: Sets or inquires the delta marker

- Parameter (when parameters are set)

- param: Setting of delta marker mode

Format: NR1 or string

NR1	String	Description
0	<b>N</b> ormal	Normal marker mode
1	<b>D</b> elta	Delta marker mode

- Answer message (when a query is run)

- param: Current delta marker mode

Format: NR1 (characters: 2) or string (to be set by **S**Etup **M**nemonic)

Answer format		Description
NR1	String	
0	NORMAL	Normal marker mode
1	DELTA	Delta marker mode

- Example setup

display marker mode delta                      Sets the delta marker mode

- Related program code

Display MArker Active

## ■ Display mode

### ?Display mode

Setup: **D**isplay mode <param1>, <param2>, <param3>

Query: **?D**isplay mode

(Answer) DISPLAY MODE <param1>, <param2>, <param3>

- General: Sets or inquires the graph display mode

- Parameter (when parameters are set)

- param1: X axis of graph

Format: NR1 or string

NR1	String	Description
0	<b>LOGS</b> sweep	Frequency (LOG, Hz)
1	<b>S</b> sweep	Frequency (LIN, Hz)
2	<b>LOGR</b>	Gain (dB) or voltage amplitude (dBV)
3	<b>R</b>	Gain (no unit) or voltage amplitude (Vrms)
4	<b>Theta</b>	Phase (deg)
5	<b>A</b>	Real part of gain (no unit) or voltage amplitude (Vrms)
6	<b>B</b>	Imaginary part of gain (no unit) or voltage amplitude (Vrms)
	Omit	None changes

- param2: Y<sub>-1</sub> axis of graph

- param3: Y<sub>-2</sub> axis of graph

Format: NR1 or string

NR1	String	Description
2	<b>RD</b> b	Gain (dB) or voltage amplitude (dBV), impedance (dBΩ), admittance
3	<b>R</b>	Gain (no unit) or voltage amplitude (Vrms), impedance (Ω), admittance (S)
4	<b>Theta</b>	Phase (deg)
5	<b>A</b>	Real part of gain (no unit) or real part of voltage amplitude (Vrms), admittance (Ω), susceptance (S)
6	<b>B</b>	Imaginary part of gain (no unit) or imaginary part of voltage amplitude (Vrms), admittance (Ω), susceptance (S)
7	<b>Minusb</b>	-B
8	<b>RLog</b>	R logarithm
9	<b>ALog</b>	A logarithm
10	<b>MALog</b>	-A logarithm
11	<b>BLog</b>	B logarithm
12	<b>MBLog</b>	-B logarithm
0	<b>Off</b>	No indication
	Omit	No change

### 3.4 Individual program code description

- The FRA5095 software version less than 1.99 character string designates the corresponding numerical value (NR1) for replacement.

NR1	String	Description
2	<b>LOGR</b>	Gain (dB) or voltage amplitude (dBV)
3	<b>R</b>	Gain (no unit) of voltage amplitude (Vrms)
4	<b>Theta</b>	Phase (deg)
5	<b>A</b>	Real part of gain (no unit) real part of voltage amplitude (Vrms)
6	<b>B</b>	Imaginary part of gain (no unit) or imaginary part of voltage amplitude (Vrms)
7	<b>Minusb</b>	- imaginary part of gain or - imaginary part of voltage amplitude (Vrms)
0	<b>Off</b>	No indication
	Omit	No change

- Answer message (when a query is run)

- param1: X axis of current graph

Format: NR1 (characters: 2) or string (to be set by **SE**up **M**nemonic)

Answer format		Description
NR1	String	
0	LOGSWEEP	Frequency (LOG, Hz)
1	SWEEP	Frequency (LIN, Hz)
2	LOGR	Gain (dB) or voltage amplitude (dBV)
3	R	Gain (no unit) or voltage amplitude (Vrms)
4	THETA	Phase (deg)
5	A	Real part of gain (no unit) or voltage amplitude (Vrms)
6	B	Imaginary part of gain (no unit) or voltage amplitude (Vrms)

- param2: Y<sub>-1</sub> axis of current graph

- param3: Y<sub>-2</sub> axis of current graph

Format: NR1 (characters: 2) or string (to be set by **SE**up **M**nemonic)

NR1	String	Description
2	RDB	Gain (dB) or voltage amplitude (dBV), impedance ( $\Omega$ ), admittance (S)
3	R	Gain (no unit) or voltage amplitude (Vrms), impedance ( $\Omega$ ), admittance
4	THETA	Phase (deg)
5	A	Real part of gain (no unit) or real part of voltage amplitude (Vrms), impedance ( $\Omega$ ), conductance (S)
6	B	Imaginary part of gain (no unit) or imaginary part of voltage amplitude (Vrms), impedance ( $\Omega$ ), susceptance (S)
7	MINUSB	-B
8	RLOG	R logarithm
9	ALOG	A logarithm
10	MALOG	-A logarithm
11	BLOG	B logarithm
12	MBLOG	-B logarithm
0	OFF	No display
	Omit	No change

### 3.4 Individual program code description

- Example setup

display mode 0, 2, 4

Sets graph to Bode diagram

Frequency - Gain (dB) - Phase

- Remarks

In the "Display mode," which is intended for graph representation, the X and Y axes can be set individually by arguments, but only the following combinations are available:

Setting Format		Display Mode
NR1	Character String	
0, 2, 4	LOGSweep, RDb, Theta	logF - dBR - $\theta$
0, 3, 4	LOGSweep, R, Theta	logF - R - $\theta$
0, 8, 4	LOGSweep, RLog, Theta	logF - logR - $\theta$
1, 2, 4	Sweep, RDb, Theta	F - dBR - $\theta$
1, 3, 4	Sweep, R, Theta	F - R - $\theta$
1, 8, 4	Sweep, RLog, Theta	F - logR - $\theta$
0, 2, 0	LOGSweep, RDb	logF - dBR
0, 3, 0	LOGSweep, R	logF - R
0, 8, 0	LOGSweep, RLog	logF - logR
1, 2, 0	Sweep, RDb	F - dBR
1, 3, 0	Sweep, R	F - R
1, 8, 0	Sweep, RLog	F - logR
0, 5, 6	LOGSweep, A, B	logF - A - B
0, 9, 11	LOGSweep, ALog, BLog	logF - logA - logB
0, 10, 11	LOGSweep, MAlLog, BLog	logF - log(-A) - logB
0, 9, 12	LOGSweep, ALog, MBLog	logF - logA - log(-B)
0, 10, 12	LOGSweep, MAlLog, MBLog	logF - log(-A) - log(-B)
1, 5, 6	Sweep, A, B	F - A - B
1, 9, 11	Sweep, ALog, BLog	F - logA - logB
1, 10, 11	Sweep, MAlLog, BLog	F - log(-A) - logB
1, 9, 12	Sweep, ALog, MBLog	F - logA - log(-B)
1, 10, 12	Sweep, MAlLog, MBLog	F - log(-A) - log(-B)
0, 4, 0	LOGSweep, Theta	logF - $\theta$
1, 4, 0	Sweep, Theta	F - $\theta$
4, 2, 0	Theta, RDb	$\theta$ - dBR
4, 3, 0	Theta, R	$\theta$ - R
4, 8, 0	Theta, RLog	$\theta$ - logR
5, 6, 0	A, B	a - b
5, 7, 0	A, Minusb	a - -b

### 3.4 Individual program code description

The units for dBR, R, A, B and Minusb will be as follows according to the current setup of the analysis mode ("Display ANalysis").

- When Display Units are set to gain

	Analysis mode "Display Analysis"	
	CH1/CH2 or CH2/CH1	CH1 or CH2
dBR	Gain (dB)	Voltage amplitude (dBV)
R	Gain (no unit)	Voltage amplitude (Vrms)
A	Real part of gain (no unit)	Real part of voltage amplitude (Vrms)
B	Imaginary part of gain (no unit)	Imaginary part of voltage amplitude (Vrms)
Minusb	-Imaginary part of gain (no unit)	-Imaginary part of voltage amplitude (Vrms)

- When Display Units are set to impedance

	Analysis mode "Display ANalysis"			
	CH1/CH2	CH2/CH1	CH1	CH2
dBR	Impedance (dB $\Omega$ )	Admittance (dBS)	Voltage amplitude (dBV)	Current amplitude (dBA)
R	Impedance ( $\Omega$ )	Admittance (S)	Voltage amplitude (Vrms)	Current amplitude (Arms)
A	Resistance ( $\Omega$ )	Conductance (S)	Real part of voltage amplitude (Vrms)	Real part of current amplitude (Arms)
B	Reactance ( $\Omega$ )	Susceptance (S)	Imaginary part of voltage amplitude (Vrms)	Imaginary part of current amplitude (Arms)

- Related program code

Display ANalysis

## ■ Display Phase

### ?Display Phase

Setup: **D**isplay Phase <param>

Query: **?D**isplay Phase

(Answer) DISPLAY PHASE <param>

- General: Sets or inquires the phase display range
- Parameter (when parameters are set)
  - param: Central value in the phase display range
  - Format: NR3
  - Range: -180, 0, 180 (deg)

param set value	Phase display range
-180	-360 to 0 deg
0	-180 to 180 deg
180	0 to 360 deg

- Answer message (when a query is run)
  - param: Central value in the current phase display range
  - Format: NR3
  - Range: -180E+00 to +180E+00  
(Available values: 180, -0, 180)
  - Characters: 11

- Example setup
 

display phase 0	Sets the phase display range to -180 to +180 deg
-----------------	--

- Remarks
 

Even when the graph is set to autoscale, the phase display range defined here will not be exceeded.

## ■ Display Scale Xaxis

### ?Display Scale Xaxis

Setup: **D**isplay **S**cale **X**axis <param1>, <param2>

Query: **?D**isplay **S**cale **X**axis

(Answer) DISPLAY SCALE XAXIS <param1>, <param2>

- General: Sets or inquires the display range for X axis of graph

- Parameter (when parameters are set)

- param1: Maximum display range for X axis of graph
- param2: Minimum display range for X axis of graph

Format: NR3

- Answer message (when a query is run)

- param1: Maximum display range for X axis of current graph
- param2: Minimum display range for X axis of current graph

Format: NR3

- Example setup

display scale x 1, 1e6

Sets the X-axis display range to 1 to 1e6

1 Hz to 1 MHz if the display mode of X axis is set to Frequency

- Remarks

The setup or query of the maximum or minimum display range for the X axis using this program code, will depend on the display mode of the current graph (to be set by "Display mode").

Display mode for X axis	Unit	When set	When queried
		Setup range	Characters
Frequency F, logF	Hz	0.1E-3 to 15E+6	17
Phase $\theta$	deg	-1.0E9 to 1.0E9	11
Real part (gain or amplitude) a	No unit or Vrms	-1.0E9 to 1.0E9	11
(Resistance, conductance) A	$\Omega$ or S	-1.0E9 to 1.0E9	11

The numeric value obtained in response to a query will be the one set in the menu [Graph][SCALE], rather than the display range of the X axis that is currently shown in the graph.

## ■ Display Scale Y1axis

### ?Display Scale Y1axis

Setup: **Display Scale Y1axis** <param1>, <param2>

Query: **?Display Scale Y1axis**

(Answer) DISPLAY SCALE Y1AXIS <param1>, <param2>

- General: Sets or inquires the display range for Y<sub>-1</sub> axis of graph

- Parameter (when parameters are set)

- param1: Maximum display range for Y<sub>-1</sub> axis of graph

- param2: Minimum display range for Y<sub>-1</sub> axis of graph

Format: NR3

- Answer message (when a query is run)

- param1: Maximum display range for Y<sub>-1</sub> axis of current graph

- param2: Minimum display range for Y<sub>-1</sub> axis of current graph

Format: NR3

- Example setup

display scale y1 0, 20

Sets the Y<sub>-1</sub>-axis display range to 0 to 20. 0 dB to 20 dB if the display mode of Y<sub>-1</sub> axis is set to Gain (dB)

- Remarks

The setup or query of the maximum or minimum display range of Y<sub>-1</sub> axis using this program code, will depend on the display mode of the current graph (to be set by "Display mode").

Display mode for Y <sub>-1</sub> axis	Unit	When set	When queried
		Setup range	Characters
Gain or amplitude R, dBR	dB or dBV	-1000 to 1000	12
	No unit or Vrms	-1.0E9 to 1.0E9	10
Phase $\theta$	deg	-1.0E9 to 1.0E9	11
Imaginary part (gain or amplitude) b, -b	No unit or Vrms	-1.0E9 to 1.0E9	11
(Impedance, admittance) R, logR, dBR	dB $\Omega$ or dBS	-1000 to 1000	12
	$\Omega$ or S	-1.0E9 to 1.0E9	10
(Resistance, conductance) A, logA, log (-A)	$\Omega$ or S	-1.0E9 to 1.0E9	11

The numeric value obtained in response to a query will be the one in the menu GraphSCALE, rather than the display range of the Y-1 axis that is currently shown in the graph.



## ■ Display Scale Y2axis

### ?Display Scale Y2axis

Setup: **D**isplay **S**cale **Y2**axis <param1>, <param2>

Query: **?D**isplay **S**cale **Y2**axis

(Answer) DISPLAY SCALE Y2AXIS <param1>, <param2>

- General: Sets or inquires the display range for Y<sub>2</sub> axis of graph
- Parameter (when parameters are set)
  - param1: Maximum display range for Y<sub>2</sub> axis of graph
  - param2: Minimum display range for Y<sub>2</sub> axis of graph
  - Format: NR3
- Answer message (when a query is run)
  - param1: Maximum display range for Y<sub>2</sub> axis of current graph
  - param2: Minimum display range for Y<sub>2</sub> axis of current graph
  - Format: NR3
- Example setup
 

display scale y2 -180, 180	Sets the Y <sub>2</sub> -axis display range to -180 to +180 ±180 deg if the display mode of Y <sub>2</sub> axis is set to Phase
----------------------------	--
- Remarks

The setup or query of the maximum or minimum display range of the Y<sub>2</sub> axis using this program code, will depend on the display mode of the current graph (to be set by "Display mode"). Only the phase can be shown on the Y<sub>2</sub> axis.

Display mode for Y <sub>2</sub> axis	Unit	When set	When queried
		Setup range	Characters
Phase $\theta$	deg	-1.0E9 to 1.0E9	11
(None displayed)	–	–	11
(Reactance, susceptance)	$\Omega$ or S	-1.0E9 to 1.0E9	11

The numeric value obtained in response to a query will be the one set in the menu GraphSCALE, rather than the display range of the Y<sub>2</sub> axis that is currently being shown in the graph. However, if a query is run while the Y<sub>2</sub> axis is not shown, then an answer will be returned with both param1 and param2 as 0.0E+0.

## ■ Display Units

### ?Display Units

Setup: **D**isplay Units <param>

Query: **?D**isplay Units

(Answer) DISPLAY UNITS <param>

- General: Display units setup

- Parameter (when parameters are set)

- param: Display units

Format: NR1 or character string

NR1	String	Description
0	<b>G</b> ain	Gain display
1	<b>I</b> mpedance	Ohms ( $\Omega$ or S) display

- Answer message (when a query is run)

- param: Present graph display window mode

Format: NR1 (character string: 2) or SEtup Mnemonic

Answer format		Description
NR1	String	
0	<b>GAIN</b>	Gain display
1	<b>IMPEDANCE</b>	Ohms ( $\Omega$ or S) display

- Example setup

display units 1

Display units set to impedance

- Remarks

Display units differ between graph and analysis modes.

- Related program code

INput Open

## ■ Display Window

### ?Display Window

Setup: **D**isplay **W**indow <param>

Query: **?D**isplay **W**indow

(Answer) DISPLAY WINDOW <param>

- General: Sets or queries the graph display window mode

- Parameter (when parameters are set)

- param: Setting of graph display window mode

Format: NR1 or string

NR1	String	Description
0	<b>S</b> ingle	Single view
1	<b>S</b> plit	Split view

- Answer message (when a query is run)

- param: Current graph display window mode

Format: NR1 (characters: 2) or string (to be set by **SE**tup **M**nemonic)

Answer format		Description
NR1	String	
0	<b>S</b> INGLE	Single view
1	<b>S</b> PLIT	Split view

- Example setup

display window split

Sets a graph to the SPLIT view mode (split it vertically into two parts)

#### ■ File DElete Disk

Setup: File DElete Disk <param>

- General: Deletes files
  
- Parameter (when parameters are set)
  - param: Name of a file to be deleted
  - Format: String
  - Range: Name strings of files that exist in a USB flash drive
  
- Example setup

file delete disk data1.dat		Deletes the data file "data1.dat"
----------------------------	--	-----------------------------------
  
- Remarks

An error will result if you specify the name of a file that does not exist.
  
- Related program code
  - ?File Dlr Disk

#### ■ File DElete Mass

Setup: File DElete Mass <param>

- General: Deletes mass memory
- Parameter (when parameters are set)
  - param: Number of mass memory to be deleted  
Format: NR1  
Range: 1 to (a number that exists in mass memory)

- Example setup

file delete mass 21                      Deletes mass memory #21

- Remarks

An error will result if you specify the number of mass memory that does not exist.

- Related program code

?File Dir Mass

#### ■ File DElete Permanent

Setup: File DElete Permanent <param>

- General: Deletes permanent memory
  
- Parameter (when parameters are set)
  - param: Number of permanent memory to be deleted
  - Format: NR1
  - Range: 1 to (a number that exists in permanent memory)
  
- Example setup

file delete mass 2	Deletes permanent memory #2
--------------------	-----------------------------
  
- Remarks

An error will result if you specify the number of permanent memory that does not exist.
  
- Related program code
  - ?File Dlr Permanent

#### ■ ?File Dlr Disk

Query: ?File Dlr Disk

(Answer) <param1>, <param2>, <param3> block delimiter

:

- General: Outputs the list of files that are stored on a in a USB flash drive
  
- Answer message (when a query is run)
  - param1: File name  
Format: Character string: filename (8-characters) + " " + filename extension (3characters)  
The characters in a file name and an extension that contains less than 8 and 3 characters respectively, will be placed to left and spaces will fill in for the missing characters.
  - param2: Date on which a file was created  
Format: String YYYY-MM-DD (year-month-day)
  - param3: Time at which a file was created  
Format: String HH:MM:SS (hour:minute:second) SS is constantly "00"Individual file names are divided by block delimiters, and the final one is followed by a delimiter.
  
- Example setup  
?file dir disk
  
- Related program codes  
?File Dlr Mass, ?File Dlr Permanent

#### ■ ?File Dlr Mass

Query: ?File Dlr Mass

(Answer) <param1>, <param2>, <param3> (block delimiter)

:

- General: Outputs the list of file numbers that are registered with mass memory

- Answer message (when a query is run)

- param1: Registration number of mass memory  
Format: NR1 (characters:5)  
Range: Registration numbers that exist in mass memory
- param2: Date on which a file was created  
Format: String YYYY-MM-DD (year-month-day)
- param3: Time at which a file was created  
Format: String HH:MM:SS (hour:minute:second) SS is constantly "00"

Individual file names are divided by block delimiters, and the final one is followed by a delimiter.

- Example setup

?file dir mass

- Related program codes

?File Dlr Disk, ?File Dlr Permanent



#### ■ ?File Dlr Permanent

Query: ?File Dlr Permanent

(Answer) <param1>, <param2>, <param3> (block delimiter)

:

- General: Outputs the list of file numbers that are registered with permanent memory

- Answer message (when a query is run)

- param1: Registration number of permanent memory  
Format: NR1 (characters:5)  
Range: Registration numbers that exist in permanent memory
- param2: Date on which a file was created  
Format: String YYYY-MM-DD (year-month-day)
- param3: Time at which a file was created  
Format: String HH:MM:SS (hour:minute:second) SS is constantly "00"

Individual file names are divided by block delimiters, and the final one is followed by a delimiter.

- Example setup

?file dir permanent

- Related program codes

?File Dlr Disk, ?File Dlr Mass

#### ■ File Load Disk data

Setup: File Load Disk data <param1>, <param2>

- General: Loads data files from a USB flash drive
  
- Parameter (when parameters are set)
  - param1: Name of a data file to be loaded (it must include the extension ".dat")
    - Format: String
    - Range: Filename strings that exist in a USB flash drive
  - param2: Tag number to which data is written
    - Format: NR1
    - Range: 1 to 6
    - omit: Current tag number
  
- Example setup
  - file load disk data data1.dat            Loads the data file "data1.dat"
  
- Remarks
  - An error will result if an attempt is made to load a file that does not exist.
  - Be sure to add ".dat" to a file name as an extension.
  
- Related program code
  - File Save Disk data

#### ■ File Load Disk Condition

Setup: **File Load Disk Condition** <param>

- **General:** Loads setup condition files from a USB flash drive
  
- **Parameter (when parameters are set)**
  - **param:** Name of a setup condition file to be loaded (it must include the extension ".con")
    - Format:** String
    - Range:** Filename strings that exist in a USB flash drive
  
- **Example setup**

file load disk condition setup1.con Loads the setup condition file "setup1.con"
  
- **Remarks**

An error will result if an attempt is made to load a file that does not exist.  
Be sure to add ".con" to a file name as an extension.  
Once a setup condition file has been loaded, the FRA5097 will follow the information in that file for its settings.
  
- **Related program code**

File Save Disk Condition



#### ■ File Load Permanent

Setup: File Load Permanent <param1>, <param2>

- General: Loads permanent data and assigns it to a tag
  
- Parameter (when parameters are set)
  - param1: File numbers that are registered with permanent memory
    - Format: NR1
    - Range: File numbers that exist in permanent memory
  - param2: Tag number to which data is written
    - Format: NR1
    - Range: 1 to 6
    - Omit: Current tag number
  
- Example setup
  - file load permanent 15, 2                      Assigns permanent memory #15 to tag 2
  
- Remarks

An error will result if an attempt is made to load the number of permanent memory that does not exist.

The list of file numbers registered with permanent memory can be read by "?File Dir Permanent".
  
- Related program codes
  - ?File Dir Permanent, File Save Permanent

## ■ File Rename Disk

Setup: **File Rename Disk** <param1>, <param2>

- **General:** Renames files in a USB flash drive
  
- **Parameter (when parameters are set)**
  - **param1:** Current file name
    - Format: String
    - Range: Names of files that exist on a USB flash drive (including extensions)
  - **param2:** New file name
    - Format: String
    - Range: Names of files that do not exist on a USB flash drive (including extensions)
  
- **Example setup**

```
file rename disk nowdata.dat old1.dat
```

Renames the file "nowdata.dat" on a USB  
flash drive into "old1.dat"
  
- **Remarks**

An error will result if you specify the name of a file not existing in param1 nor the name of a file existing in a USB flash drive in param2.

The list of files disk can be read by "?File Dlr Disk".
  
- **Related program codes**

?File Dlr Disk, File DElete Disk

#### ■ File Save Disk data

Setup: File Save Disk data <param1>, <param2>

- General: Saves tag data in a USB flash drive
  
- Parameter (when parameters are set)
  - param1: Tag number of data to be saved
    - Format: NR1
    - Range: 1 to 6
    - omit: Current tag number
  - param2: Name of a file to be saved, including the extension ".dat"
    - Format: String
  
- Example setup
  - file save disk data 1, data1.dat      Saves tag 1 data to a USB flash drive as "data1.dat"
  
- Remarks

If another file with an identical name is already in the USB flash drive, then it will be overwritten, so that the previous file data will be cleared.
  
- Related program codes

File Save Disk Condition, File Load Disk data, ?File Dlr Disk

#### ■ File Save Disk Condition

Setup: File Save Disk Condition <param>

- General: Saves setup conditions to a USB flash drive
  
- Parameter (when parameters are set)
  - param: Name of a file to be saved, including the extension ".con"
  - Format: String
  
- Example setup  
file save disk condition setup1.con Saves the current setup conditions to a USB flash drive as "setup1.con"
  
- Remarks  
If another file with an identical name is already present in the USB flash drive, it will be overwritten, so that the previous file data will be cleared.
  
- Related program codes  
File Save Disk data, File Load Disk data, ?File Dir Disk



## ■ File Save Mass

Setup: **File Save Mass** <param1>, <param2>

- **General:** Stores tag data to mass memory
- **Parameter (when parameters are set)**
  - **param1:** Tag number to which tag data is stored  
Format: NR1  
Range: 1 to 6  
omit: Current tag number
  - **param2:** Mass memory number to which data is stored  
Format: NR1  
Range: 1 to 999  
omit: Generates a memory number automatically

- **Example setup**

file save mass 3, 5

Stores tag 3 data to mass memory #5

- **Remarks**

Unique mass memory and permanent memory numbers are assigned to ensure that they are not identical.

If a mass memory number in which data is to be stored already exists, the data will be overwritten and cleared. Similarly, if some data is written in a mass memory number identical to a permanent memory number that already exists, the permanent memory data will be deleted.

If param2 is omitted, the subsequent number of the last memory number in which data was stored, will be generated automatically.

If some data already exists in the mass or permanent memory of that number, the data will be overwritten.

- **Related program codes**

File Load Mass, ?File Dir Mass

## ■ File Save Permanent

Setup: File Save Permanent <param1>, <param2>

- General: Stores tag data in permanent memory
  
- Parameter (when parameters are set)
  - param1: Tag number to which tag data is stored
    - Format: NR1
    - Range: 1 to 6
    - omit: Current tag number
  - param2: Permanent memory number to which tag data is stored
    - Format: NR1
    - Range: 1 to 999
    - omit: Generates a memory number automatically

- Example setup

file save permanent 2, 1                      Stores tag 2 data to permanent memory #1

- Remarks

Unique mass memory and permanent memory numbers will be assigned to ensure that they are not identical.

If a permanent memory number to which data is to be stored already exists, the data will be overwritten and cleared. Similarly, if some data is written in a permanent memory number identical to a mass memory number that already exists, the mass memory data item will be deleted.

If param2 is omitted, the subsequent number of the last memory number to which data was stored, will be generated automatically. If some data already exists in the mass or permanent memory of that number, the data will be overwritten.

- Related program codes

File LoadPermanent, ?File Dir Permanent

## ■ INput Action

### ?INput Action

Setup: **IN**put Action <param1>, <param2>

Query: **?IN**put Action

(Answer) INPUT ACTION <param1>, <param2>

- General: Sets or inquires the action taken when overload input is detected

- Parameter (when parameters are set)

- param1: Buzzer action when overload input is detected

Format: NR1 or string

NR1	String	Description
0	<b>OFF</b>	No buzzer sounds
1	<b>ON</b>	Buzzer sounds

Omit: None changes

- param2: Oscillator and sweep when overload input is detected

Format: NR1 or string

NR1	String	Description
0	<b>OFF</b>	Oscillation & sweep continue
1	<b>Sweep</b>	Only sweep stops
2	<b>OSc</b>	Oscillation & sweep stop

Omit: None changes

- Answer message (when a query is run)

- param1: Current buzzer action when overload input is detected

Format: NR1 (characters: 2) or string (to be set by **SE**tup **M**nemonic)

Answer format		Description
NR1	String	
0	OFF	No buzzer sounds
1	ON	Buzzer sounds

- param2: Current oscillator and sweep when overload input is detected

Format: NR1 (characters: 2) or string (to be set by **SE**tup **M**nemonic)

Answer format		Description
NR1	String	
0	OFF	Oscillation & sweep continue
1	SWEEP	Only sweep stops
2	OSC	Oscillation & sweep stop

- Example setup

input action ON,OSC

Stops both oscillation and sweep when overload input is detected

## ■ INput CAIculate

### ?INput CAIculate

Setup: **IN**put **CA**lculate <param1>, <param2>, <param3>

Query: **?IN**put **CA**lculate

(Answer) INPUT CALCULATE <param1>, <param2>, <param3>

- General: Sets or inquires the input weights

- Parameter (when parameters are set)

- param1: Number to be applied to CH1 input

Format: NR3

Range: 0.0 to 1.0E+6

Omit: None changes

- param2: Number to be applied to CH2 input

Format: NR3

Range: 0.0 to 1.0E+6

Omit: None changes

- param3: Phase invert

Format: NR1 or character string

NR1	String	Description
0	<b>OFF</b>	Phase not inverted
1	<b>ON</b>	Phase inverted

Omit: None changes

- Answer message (when a query is run)

- param1: Number to be applied to the current CH1 input

Format: NR3

Range: 0.00E+00 to 1.00E+06

Characters: 9

- param2: Number to be applied to the current CH2 input

Format: NR3

Range: 0.00E+00 to 1.00E+06

Characters: 9

- param3: Phase invert

Format: NR1 (character string: 2) or SEtup Mnemonic

Answer format		Description
NR1	String	
0	OFF	Phase not inverted
1	ON	Phase inverted

- Example setup

input calculate 0.5, 1.0

CH1 factor: 0.5, CH2 factor: 1.0

## ■ INput Equalize

### ?INput Equalize

Setup: **IN**put Equalize <param>

Query: **?IN**put Equalize

(Answer) INPUT EQUALIZE <param>

- General: Sets or inquires the input equalization process

- Parameter (when parameters are set)

- param: ON/OFF status of equalization

Format: NR1 or string

NR1	String	Description
0	<b>OFF</b>	Not equalized
1	<b>ON</b>	Equalized

- Answer message (when a query is run)

- param: ON/OFF status of current equalization

Format: NR1 (characters: 2) or string (to be set by SEtup Mnemonic)

Answer format		Description
NR1	String	
0	OFF	Not equalized
1	ON	Equalized

- Example setup

input equalize on

Performs equalization

- Related program code

DAta Equalize

## ■ INput Open

### ?INput Open

Setup: **IN**put **O**pen <param>

Query: **?IN**put **O**pen

(Answer) INPUT OPEN <param>

- General: Open equalize function setting/query

- Parameter (when setting)

- param: Open equalize on/off

Format: NR1 or character string

NR1	String	Description
0	<b>OFF</b>	Without open correction
1	<b>ON</b>	Open equalized

- Response message (when query sent)

- param: Present open equalize on/off state

Format: NR1 (character string: 2) or character string SEtup Mnemonic

Answer format		Description
NR1	String	
0	OFF	Without open correction
1	ON	Open equalized

- Usage example

input open on

With open correction

- Related program code

DAta Open

## ■ INput OVer

### ?INput OVer

Setup: **INput OVer** <param1>, <param2>

Query: **?INput OVer**

(Answer) INPUT OVER <param1>, <param2>

- General: Sets or inquires the detection level for overload input

- Parameter (when parameters are set)

- param1: Detection level for CH1 overload

Format: NR3

Range: 0 to 250 (Vrms)

Omit: None changes

- param2: Detection level for CH2 overload

Format: NR3

Range: 0 to 250 (Vrms)

Omit: None changes

- Answer message (when a query is run)

- param1: Current detection level for CH1 overload

Format: NR3

Range: 0.00E+00 to 250E+00

Characters: 9

- param2: Current detection level for CH2 overload

Format: NR3

Range: 0.00E+00 to 250E+00

Characters: 9

- Example setup

input over 123, 10e-3

CH1: 123 Vrms, CH2: 10 mVrms

?input over

(Answer) 123E+00, 10E-03

## ■ INput Short

### ?INput Short

Setup: **IN**put **S**hort <param>

Query: **?IN**put **S**hort

(Answer) INPUT SHORT <param>

- General: Short correction function set/query

- Parameter (when setting)

- param: Short function on/off

Format: NR1 or character string

NR1	String	Description
0	<b>OFF</b>	Without short correction
1	<b>ON</b>	With short correction

- Answer message (when a query is run)

- param: Present short on/off state

Format: NR1 (character string: 2) or character string SEtup Mnemonic setting

Answer format		Description
NR1	String	
0	OFF	Without short correction
1	ON	With short correction

- Example setup

input short on

Short is corrected

- Related program code

DAta Short



## ■ Measure Auto M<sub>A</sub>X Cycle

### ?Measure Auto M<sub>A</sub>X Cycle

Setup: **Measure Auto M<sub>A</sub>X Cycle** <param>

Query: **?Measure Auto M<sub>A</sub>X Cycle**

(Answer) MEASURE AUTO MAX CYCLE <param>

- General: Sets or inquires the maximum cycles of automatic integration
  
- Parameter (when parameters are set)
  - param: Maximum cycles of integration  
Format: NR1  
Range: 2 to 9999 (cycles)
  
- Answer message (when a query is run)
  - param: Current maximum cycles of integration  
Format: NR1  
Range: 2 to 9999  
Characters: 5
  
- Example setup  
measure auto max cycle 100                      Max cycles of automatic integration: 100
  
- Remarks  
This setup will not be valid unless "Measure Auto M<sub>A</sub>X Type" is set to 0 or Cycle.
  
- Related program codes  
Measure Auto M<sub>A</sub>X Sec, Measure Auto M<sub>A</sub>X Type

## ■ Measure Auto M<sub>A</sub>x Sec

### ?Measure Auto M<sub>A</sub>x Sec

Setup: **Measure Auto M<sub>A</sub>x Sec** <param>

Query: **?Measure Auto M<sub>A</sub>x Sec**

(Answer) MEASURE AUTO MAX SEC <param>

- General: Sets or inquires the maximum time of automatic integration
  
- Parameter (when parameters are set)
  - param: Maximum integration time  
Format: NR3  
Range: 0 to 9999 (sec)
  
- Answer message (when a query is run)
  - param: Current maximum integration time  
Format: NR3  
Range: 0.00000E+00 to 9.99900E+03  
Characters: 12
  
- Example setup  
measure auto max sec 1                      Max time of automatic integration: 1 second
  
- Remarks  
Two cycles of integration will definitely be run regardless of the setup. Therefore, even when the integration time is set to 0 second, the measuring time will be two seconds or more at a measuring frequency of 1 Hz.  
This setup will not be valid unless "Measure Auto M<sub>A</sub>x Type" is set to 1 or Sec.
  
- Related program codes  
Measure Auto M<sub>A</sub>x Cycle, Measure Auto M<sub>A</sub>x Type

## ■ Measure Auto MAx Type

### ?Measure Auto MAx Type

Setup: **Measure Auto MAx Type** <param>

Query: **?Measure Auto MAx Type**

(Answer) MEASURE AUTO MAX TYPE <param>

- General: Sets or inquires the setting type of maximum automatic integration
- Parameter (when parameters are set)
  - param: Setting type of maximum integration
  - Format: NR1 or string

NR1	String	Description
0	<b>Cycle</b>	Set by a number of times (cycles)
1	<b>Sec</b>	Set by time

- Answer message (when a query is run)
  - param: Current setting type of maximum integration
  - Format: NR1 (characters: 2) or string (to be set by **SE**up **M**nemonic)

Answer format		Description
NR1	String	
0	CYCLE	Set by a number of times (cycles)
1	SEC	Set by time

- Example setup
 

measure auto max type cycle	Sets automatic integration by a number of times (cycles)
-----------------------------	--
- Remarks
 

Although the maximum level of automatic integration can be set individually using "Measure Auto MAx Cycle" and "Measure Auto MAx Sec", it is the automatic integration set by this program code that will actually be used.
- Related program codes
 

Measure Auto MAx Cycle, Measure Auto MAx Sec

■ **Measure Auto mode**

?Measure Auto mode

Setup: **Measure Auto mode** <param>

Query: **?Measure Auto mode**

(Answer) MEASURE AUTO MODE <param>

- General: Sets or inquires the action of automatic integration

Parameter (when parameters are set)

- param: Action of automatic integration

Format: NR1 or string

NR1	String	Description
0	Off	Manual integration mode
1	Short	SHORT mode
2	Long	LONG mode

- Answer message (when a query is run)

- param: Action of current automatic integration

Format: NR1 (characters: 2) or string (to be set by **SE**tup **M**nemonic)

Answer format		Description
NR1	String	
0	OFF	Manual integration mode
1	SHORT	SHORT mode
2	LONG	LONG mode

- Example setup

measure auto mode SHORT

Set the automatic integration of SHORT mode

- Related program code

Measure Coherence

## ■ Measure Coherence

### ?Measure Coherence

Setup: **M**easure **C**oherence <param>

Query: **?M**easure **C**oherence

(Answer) MEASURE COHERENCE <param>

- General: Sets or inquires the coherence calculation mode
- Parameter (when parameters are set)
  - param: Coherence calculation mode

Format: NR1 or string

NR1	String	Description
0	Off	OFF
1	CH1	CH1
2	CH2	CH2
3	Both	CH1&CH2

- Answer message (when a query is run)
    - param: Current coherence calculation mode
- Format: NR1 (characters: 2) or string (to be set by **SE**up **M**nemonic)

Answer format		Description
NR1	String	
0	OFF	OFF
1	CH1	CH1
2	CH2	CH2
3	BOTH	CH1&CH2

- Example setup
 

measure coherence CH1                      Coherence mode: CH1

- Remarks
 

If this is set to Off, a calculation process will be executed internally in CH1&CH2 (Both).

- Related program code
 

Measure Auto mode

## ■ Measure Delay Cycle

### ?Measure Delay Cycle

Setup: **Measure Delay Cycle** <param>

Query: **?Measure Delay Cycle**

(Answer) MEASURE DELAY CYCLE <param>

- General: Sets or inquires the delay cycles for measurement start
  
- Parameter (when parameters are set)
  - param: Delay cycles  
Format: NR1  
Range: 0 to 9999 (cycles)
  
- Answer message (when a query is run)
  - param: Current delay cycles  
Format: NR1  
Range: 0 to 9999  
Characters: 5
  
- Example setup  
measure delay cycle 10                      Delay cycles for measurement start: 10
  
- Remarks  
Since the delay cycles indicate the number of cycles (= the reciprocal of the frequency to be analyzed), the delay time will vary according to the frequency to be analyzed.  
This setup will not be valid unless "Measure Delay Type" is set to 0 or Cycle.
  
- Related program codes  
Measure Delay Sec, Measure Delay Type

## ■ Measure Delay Sec

### ?Measure Delay Sec

Setup: **Measure Delay Sec** <param>

Query: **?Measure Delay Sec**

(Answer) MEASURE\_DELAY\_SEC <param>

- General: Sets or inquires the delay time for measurement start
  
- Parameter (when parameters are set)
  - param: Delay time for measurement start  
Format: NR3  
Range: 0 to 9999.0 (sec)  
Resolution: 10 msec
  
- Answer message (when a query is run)
  - param: Current delay time  
Format: NR3  
Range: 0.00000E+00 to 9.99900E+03  
Characters: 12
  
- Example setup  
measure delay sec 0.1                      Delay in measurement start: 0.1 secs
  
- Remarks  
This command will define the delay time that can be set regardless of the frequency to be analyzed.  
This setup will not be valid unless "Measure Delay Type" is set to 1 or Sec.
  
- Related program codes  
Measure Delay Cycle, Measure Delay Type

## ■ Measure Delay Type

### ?Measure Delay Type

Setup: **Measure Delay Type** <param>

Query: **?Measure Delay Type**

(Answer) MEASURE DELAY TYPE <param>

- General: Sets or inquires the setting type of delay in measurement start
- Parameter (when parameters are set)
  - param: Setting type of delay in measurement start
  - Format: NR1 or string

NR1	String	Description
0	<b>Cycle</b>	Set by a number of times (cycles)
1	<b>Sec</b>	Set by time

- Answer message (when a query is run)
  - param: Current setting type of delay in measurement start
  - Format: NR1 (characters: 2) or string (to be set by SSetup Mnemonic)

Answer format		Description
NR1	String	
0	CYCLE	Set by a number of times (cycles)
1	SEC	Set by time

- Example setup
 

measure delay type sec	Sets delay in measurement start by means of time
------------------------	--
- Remarks
 

Although the delay in measurement start can be set individually using "Measure Delay Cycle" and "Measure Delay Sec", it is the delay set by this program code that will actually be used.
- Related program codes
 

Measure Delay Cycle, Measure Delay Sec



#### ■ Measure Harmonic

##### ?Measure Harmonic

Setup: **M**measure **H**armonic <param>

Query: **?M**measure **H**armonic

(Answer) MEASURE\_HARMONIC <param>

- General: Sets or inquires the order of harmonic analysis

- Parameter (when parameters are set)

- param: Order of harmonics to be analyzed
  - Format: NR1
  - Range: 1 to 10 (orders)
  - Resolution: 1

- Answer message (when a query is run)

- param: Current order of harmonics to be analyzed
  - Format: NR1
  - Range: 1 to 10
  - Characters: 3

- Example setup

measure harmonic 3

Analyzes the 3rd order harmonic content

## ■ Measure Integration Cycle

### ?Measure Integration Cycle

Setup: **Measure Integration Cycle** <param>

Query: **?Measure Integration Cycle**

(Answer) MEASURE INTEGRATION CYCLE <param>

- General: Sets or inquires the cycles of manual integration

- Parameter (when parameters are set)

- param: Cycles of integration
- Format: NR1
- Range: 1 to 9999 (cycles)

- Answer message (when a query is run)

- param: Current cycles of integration
- Format: NR1
- Range: 1 to 9999
- Characters: 5

- Example setup

measure integration cycle 10            10 cycles of manual integration

- Remarks

This setup will not be valid unless "Measure Integration Type" is set to 0 or Cycle.

The set cycles of integration will be run regardless of the cycles of the frequency to be analyzed.

Shown below is the approximate measuring time when the frequency to be analyzed is defined as f and the cycles of integration as n.

- $f \leq \text{approx } 54 \text{ Hz}$ :             $n/f$
- $\text{aprox } 54 \text{ Hz} < f < 3 \text{ kHz}$ :     $(18.2 \text{ to } 54.6 \text{ ms}) \times n$
- $3 \text{ kHz} \leq f$ :                         $\text{approx } 18.2 \text{ ms} \times n$

- Related program codes

Measure Integration Sec, Measure Integration Type

## ■ Measure Integration Sec

### ?Measure Integration Sec

Setup: **Measure Integration Sec** <param>

Query: **?Measure Integration Sec**

(Answer) MEASURE INTEGRATION SEC <param>

- General: Sets or inquires the integration time

- Parameter (when parameters are set)

- param: Integration time  
Format: NR3  
Range: 0 to 9999.0 (secs)  
Resolution: 10 msec

- Answer message (when a query is run)

- param: Current integration time  
Format: NR3  
Range: 0.00000E+00 to 9.99900E+03  
Characters: 12

- Example setup

measure integration sec 1                      Integration time: 1 sec

- Remarks

The integration time will be set regardless of the frequency to be analyzed.

This setup will not be valid unless "Measure Integration Type" is set to 1 or sec.

- Related program codes

Measure Integration Cycle, Measure Integration Type

## ■ Measure Integration Type

### ?Measure Integration Type

Setup: **Measure Integration Type** <param>

Query: **?Measure Integration Type**

(Answer) MEASURE INTEGRATION TYPE <param>

- General: Sets or inquires the setting type of integration

- Parameter (when parameters are set)

- param: Setting type of integration

Format: NR1 or string

NR1	String	Description
0	<b>Cycle</b>	Set by a number of times (cycles)
1	<b>Sec</b>	Set by time

- Answer message (when a query is run)

- param: Current setting type of integration

Format: NR1 (characters: 2) or string (to be set by **SE**up **M**nemonic)

Answer format		Description
NR1	String	
0	CYCLE	Set by a number of times (cycles)
1	SEC	Set by time

- Example setup

measure integration type cycle      Sets integration by a number of times

- Remarks

Although integration can be set individually using "Measure Integration Cycle" and "Measure Integration Sec", it is the integration level set by this program code that will actually be used.

- Related program codes

Measure Integration Cycle, Measure Integration Sec

## ■ Measure Mode

### ?Measure Mode

Setup: **Measure Mode** <param>

Query: **?Measure Mode**

(Answer) MEASURE MODE <param>

- General: Sets or inquires the measurement mode

- Parameter (when parameters are set)

- param: Measurement mode

Format: NR1 or string

NR1	String	Description
0	<b>CH1Ch2</b>	CH1,CH2
1	<b>CH1Osc</b>	CH1,OSC
2	<b>Oscch2</b>	OSC,CH2

Omit: CH1,CH2

- Answer message (when a query is run)

- param: Current measurement mode

Format: NR1 (characters: 2) or string (to be set by **SEtup Mnemonic**)

Answer format		Description
NR1	String	
0	CH1CH2	CH1,CH2
1	CH1OSC	CH1,OSC
2	OSCCH2	OSC,CH2

- Example setup

measure mode CH1CH2

Measurement mode: CH1,CH2

## ■ Measure Repeat

### ?Measure Repeat

Setup: **Measure Repeat** <param>

Query: **?Measure Repeat**

(Answer) MEASURE REPEAT <param>

- General: Sets or inquires the measurement (Repeat) mode

- Parameter (when parameters are set)

- param: Setting of the measure repeat mode

Format: NR1 or string

NR1	String	Description
0	<b>OFF</b>	OFF
1	<b>ON</b>	ON

- Answer message (when a query is run)

- param: Current measure repeat mode

Format: NR1 (characters: 2) or string (to be set by **SE**tup **M**nemonic)

Answer format		Description
NR1	String	
0	OFF	OFF
1	ON	ON

- Example setup

measure repeat 0

Turns OFF the measure repeat mode

- Remarks

This command corresponds to the operation that is executed by the REPEAT key on the front panel.

## ■ OScillator Amplitude

### ?OScillator Amplitude

Setup: **O**Scillator **A**mplitude <param>

Query: **?O**Scillator **A**mplitude

(Answer) OSCILLATORAMPLITUDE <param>

- General: Sets or inquires the output amplitude of the oscillator

- Parameter (when parameters are set)

- param: Output amplitude (when output open)

Format: NR3

Range: 0 to 10 (Vpeak)

Resolution: Up to 3 digits, 10  $\mu$  V

- Answer message (when a query is run)

- param: Current output amplitude (when output open)

Format: NR3

Range: 0.00E-00 to 10.0E+00

Characters: 9

- Example setup

oscillator amplitude 5.00

Sets the amplitude to 5 V

- Remarks

Even if the output amplitude is modified with this program code, the actual output amplitude will not be changed unless the oscillator output is set to ON in the "OScillator mode".

- Related program code

OScillator mode

## ■ **OScillator Frequency**

### ?**OScillator Frequency**

Setup: **OScillator Frequency** <param>

Query: **?OScillator Frequency**

(Answer) OSCILLATOR FREQUENCY <param>

- General: Sets or inquires the oscillator frequency
  
- Parameter (when parameters are set)
  - param: Oscillator frequency  
Format: NR3  
Range: 0.1E-3 to 15E+6(Hz)  
Resolution: 0.1E - 3 (0.1 mHz)
  
- Answer message (when a query is run)
  - param: Current oscillator frequency  
Format: NR3  
Range: 0.1E-03 to 15.000000000E+06  
Characters: 17
  
- Example setup  
oscillator frequency 1.0e6                      Sets the oscillator frequency to 1 MHz



## ■ **O**scillator mode

### ?**O**scillator mode

Setup: **O**scillator mode <param1>, <param2>, <param3>

Query: ?**O**scillator mode

(Answer) OSCILLATOR MODE <param1>, <param2>, <param3>

- General: Sets or inquires the voltage change mode

- Parameter (when parameters are set)

- param1: Oscillator ON/OFF

Format: NR1 or string

NR1	String	Description
0	<b>OFF</b>	AC/DC OFF
1	<b>A</b> coff	Only AC is OFF
2	<b>ON</b>	AC/DC ON
	Omit	None changes

- param2: Voltage change mode of oscillator (SLOW ON/OFF setup)

Format: NR1 or string

NR1	String	Description
0	<b>Quick</b>	Output changes just after ON/OFF
1	<b>Slow</b>	SLOW ON/OFF mode
	Omit	None changes

- param3: Oscillator stop mode

Format: NR1 or string

NR1	String	Description
0	<b>Zero</b>	Stops at 0 V
1	<b>Hold</b>	Stops in current phase
2	<b>Phase</b>	Stops in specified phase * <sup>1</sup>
	Omit	None changes

\*1: The stop phase can be set by "oscillator phase".

### 3.4 Individual program code description

- Answer message (when a query is run)

- param1: Current ON/OFF status of oscillator

Format: NR1 (characters: 2) or string (to be set by **SE**up **M**nemonic)

Answer format		Description
NR1	String	
0	OFF	AC/DC OFF
1	ACOFF	Only AC is OFF
2	ON	AC/DC ON
3	TRANSITION	In transition

- param2: Voltage change mode of current oscillator

Format: NR1 (characters: 2) or string (to be set by **SE**up **M**nemonic)

Answer format		Description
NR1	String	
0	QUICK	Output changes just after ON/OFF
1	SLOW	SLOW ON/OFF mode

- param3: Current oscillator stop mode

Format: NR1 (characters: 2) or string (to be set by **SE**up **M**nemonic)

Answer format		Description
NR1	String	
0	ZERO	Stops at 0 V
1	HOLD	Stops in current phase
2	PHASE	Stops in specified phase

- Example setup

oscillator mode off,0,0

Turns AC/DC OFF at once. The stop phase is 0 V.

?oscillator mode

(Answer) OFF, QUICK, ZERO

- Related program code

Oscillator Phase

## ■ **OScillator OFFSet**

### ?OScillator OFFSet

Setup: **OScillator OFFSet** <param>

Query: **?OScillator OFFSet**

(Answer) OSCILLATOR OFFSET <param>

- General: Sets or inquires the DC bias
  
- Parameter (when parameters are set)
  - param: DC bias (when output open)
    - Format: NR3
    - Range: -10 to +10 (V)
    - Resolution: 10E-3 (10 mV)
  
- Answer message (when a query is run)
  - param: Current DC bias (when output open)
    - Format: NR3
    - Range: -10.00E+00 to +10.00E+00
    - Characters: 10
  
- Example setup  
oscillator offset 1.0                      DC bias: 1.0 V
  
- Remarks  
Even if the output bias is modified by this program code, the actual output bias will not be changed unless the oscillator output is set to ON in the "OScillator mode".
  
- Related program code  
OScillator mode

## ■ OScillator Phase

### ?OScillator Phase

Setup: **O**Scillator **P**hase <param>

Query: **?O**Scillator **P**hase

(Answer) OSCILLATOR PHASE <param>

- General: Sets or inquires the start/stop phase of the oscillator
  
- Parameter (when parameters are set)
  - param: Start/stop phase
    - Format: NR1
    - Range: 0 to 359 (deg)
    - Resolution: 1 (deg)
  
- Answer message (when a query is run)
  - param: Current start/stop phase
    - Format: NR1
    - Range: 0 to 359
    - Characters: 4
  
- Example setup
 

oscillator phase 90	Start/stop phase: 90 deg Stops at a peak on the positive side of sine wave
---------------------	---
  
- Remarks
 

If this command has been received while the oscillator is ON (either AC or DC or both), an operation in sequence of SLOW OFF → SLOW ON → output ON will result, so that the oscillator output will be turned OFF temporarily. When the oscillator is in process of SLOW ON (i.e., while the amplitude is increasing), an operation of SLOW OFF → SLOW ON will start in a new phase. Whether or not the oscillator amplitude is changing due to SLOW ON or SLOW OFF, can be checked in the "?OScillator mode".
  
- Related program code
  - OScillator mode

■ **OScillator Waveform**

?**OScillator Waveform**

Setup: **OScillator Waveform** <param>

Query: ?**OScillator Waveform**

(Answer) OSCILLATOR WAVEFORM <param>

- General: Sets or inquires the oscillator waveform

- Parameter (when parameters are set)

- param: Selected waveform

Format: NR1 or string

NR1	String	Description
0	<b>S</b> ine	Sine wave
1	<b>SQ</b> uare	Square wave
2	<b>T</b> riangle	Triangular wave

- Answer message (when a query is run)

- param: Current waveform

Format: NR1 (characters: 2) or string (to be set by **SE**tup **M**nemonic)

Answer format		Description
NR1	String	
0	SINE	Sine wave
1	SQUARE	Square wave
2	TRIANGLE	Triangular wave

- Example setup

oscillator waveform 0

Sets the oscillator waveform to sine wave

## ■ **SE**up **B**uzzer

### ?**SE**up **B**uzzer

Setup: **SE**up **B**uzzer <param>

Query: ?**SE**up **B**uzzer

(Answer) SETUP BUZZER <param>

- General: Sets the buzzer to ON/OFF

- Parameter (when parameters are set)

- param: Buzzer ON/OFF

Format: NR1 or string

NR1	String	Description
0	<b>OFF</b>	Buzzer OFF
1	<b>ON</b>	Buzzer ON

- Answer message (when a query is run)

- param: Current buzzer ON/OFF setup

Format: NR1 (characters: 2) or string (to be set by **SE**up **M**nemonic)

Answer format		Description
NR1	String	
0	OFF	Buzzer OFF
1	ON	Buzzer ON

- Example setup

setup buzzer ON

Sets the buzzer to ON

- Remarks

This command will determine whether or not to sound a buzzer when an overload input has been detected or an error has occurred. The click that is heard when hitting a key is not affected by this setup.

#### ■ S~~E~~tup Calibration

Setup: S~~E~~tup Calibration

- General: Performs a calibration

- Example setup

setup calibration

Performs a calibration

- Remarks

FRA5097 error compensation (calibration)is conducted. End of calibration is indicated by Bit 1 of status byte. **See Table 2-1 Status Byte.**

## ■ SSetup Date

### ?SSetup Date

Setup: **SSetup Date** <param1>, <param2>, <param3>

Query: **?SSetup Date**

(Answer) SETUP\_DATE <param1>, <param2>, <param3>

- General: Sets or inquires the date
  
- Parameter (when parameters are set)
  - param1: Year  
Format: NR1            Range: 1970 to 2069  
omit: None changes
  - param2: Month  
Format: NR1            Range: 1 to 12  
omit: None changes
  - param3: Day  
Format: NR1            Range: 1 to 31  
omit: None changes
  
- Answer message (when a query is run)
  - param1: Year  
Format: NR1, 5 characters    Range: 1970 to 2069
  - param2: Month  
Format: NR1, 3 characters    Range: 1 to 12
  - param3: Day  
Format: NR1, 3 characters    Range: 1 to 31
  
- Example setup  
    setup date 2001, 7, 14                      Sets the internal calendar to July 14, 2001
  
- Related program code  
    SSetup Time



## ■ SEtup Header

### ?SEtup Header

Setup: **SEtup Header** <param>

Query: **?SEtup Header**

(Answer) SETUP HEADER <param>

- General: Sets or inquires the header ON/OFF status

- Parameter (when parameters are set)

- param: Setup of header ON/OFF

Format: NR1 or string

NR1	String	Description
0	OFF	Header OFF
1	ON	Header ON

- Answer message (when a query is run)

- param: Current setup of header ON/OFF

Format: NR1 (characters: 2) or string (to be set by SEtup Mnemonic)

Answer format		Description
NR1	String	
0	OFF	Header OFF
1	ON	Header ON

- Example setup

setup header ON

Sets the header to ON

- Remarks

This command will set whether or not to prefix a header to an answer message to a query message (a program code prefixed with "?").

The header will be set to OFF when a DCL or a SDC has been received or by power on.

## ■ SSetup Initialize

Setup: **S**Setup Initialize

- General: Sets the initialization

- Example setup

setup initialize

Initializes

- Remarks

If this command is executed, the settings on the FRA5097 will be initialized, except that the following ones will remain.

- GPIB address
- GPIB delimiter
- Contents of mass memory and permanent memory
- External control selection (GPIB/USB)

For details on initialization, refer to the "**FRA5097 INSTRUCTION MANUAL**".

## ■ **SE**up **M**nemonic

### ?**SE**up **M**nemonic

Setup: **SE**up **M**nemonic <param>

Query: ?**SE**up **M**nemonic

(Answer) SETUP MNEMONIC <param>

- General: Sets or inquires the numeric format/mnemonic format for an answer string
- Parameter (when parameters are set)
  - param: Mnemonic ON/OFF setup
  - Format: NR1 or string

NR1	String	Description
0	<b>OFF</b>	Numeric format
1	<b>ON</b>	Mnemonic format

- Answer message (when a query is run)
  - param: Current mnemonic ON/OFF setup
  - Format: NR1 (characters: 2) or string (to be set by **SE**up **M**nemonic)

Answer format		Description
NR1	String	
0	–	Numeric format
–	ON	Mnemonic format

- Example setup
 

setup mnemonic ON	Sets the answer format to mnemonic
-------------------	------------------------------------

- Remarks
 

This command will determine whether to use the NR1 format (Mnemonic OFF) or the mnemonic format (Mnemonic ON) for the NR1- or string-format answer messages to queries.

## ■ SSetup Time

### ?SSetup Time

Setup: **S**Setup Time <param1>, <param2>, <param3>

Query: **?S**Setup Time

(Answer) SETUP\_TIME <param1>, <param2>, <param3>

- General: Sets or inquires the time
  
- Parameter (when parameters are set)
  - param1: Time  
Format: NR1           Range: 0 to 23 (24-hour system)  
Omit: None changes
  - param2: Minute  
Format: NR1           Range: 0 to 59  
Omit: None changes
  - param3: Second  
Format: NR1           Range: 0 to 59  
Omit: None changes
  
- Answer message (when a query is run)
  - param1: Time  
Format: NR1, 3 characters   Range: 0 to 23
  - param2: Minute  
Format: NR1, 3 characters   Range: 0 to 59
  - param3: Second  
Format: NR1, 3 characters   Range: 0 to 59
  
- Example setup  
    setup time 14, 0, 0                               Sets the internal clock to 14:00
  
- Related program code  
    SSetup Date

■ **SWEEP MANUAL**

**?SWEEP MANUAL**

Setup: **SWEEP MANUAL** <param>

Query: **?SWEEP MANUAL**

(Answer) SWEEP MANUAL <param>

- General: Sets or inquires the manual/automatic sweep

- Parameter (when parameters are set)

- param: Sweep type

Format: NR1 or string

NR1	String	Description
0	OFF	Automatic sweep
1	ON	Manual sweep

- Answer message (when a query is run)

- param: Current sweep type

Format: NR1 (characters: 2) or string (to be set by **SETUP MNEMONIC**)

Answer format		Description
NR1	String	
0	OFF	Automatic sweep
1	ON	Manual sweep

- Example setup

sweep manual 0

Sets the automatic sweep mode

- Related program code

SWEEP MEASURE

## ■ SWEEP MEASURE

### ?SWEEP MEASURE

Setup: **SWEEP MEASURE** <param>

Query: **?SWEEP MEASURE**

(Answer) SWEEP MEASURE <param>

- General: Controls or inquires a sweep measurement

- Parameter (when parameters are set)

- param: Control of a sweep measurement

Format: NR1 or string

NR1	String	Description
0	<b>Stop</b>	Interrupts a sweep
1	<b>Hold</b>	Holds a sweep; or starts Single/Repeat measurement
2	<b>Up</b>	Starts Up sweep
3	<b>Down</b>	Starts Down sweep

- Answer message (when a query is run)

- param: Current status of sweep measurement

Format: NR1 (characters: 2) or string (to be set by Setup Mnemonic)

Answer format		Description
NR1	String	
0	STOP	Sweep stopped status
1	HOLD	Sweep held status or Single/Repeat measurement in progress
2	UP	Up sweep in progress
3	DOWN	Down sweep in progress
-1	CALIBRATION	Calibration in progress

- Example setup

sweep measure up

Starts an Up sweep measurement

- Remarks

The action that results from the program code "SWEEP MEASURE Hold", will vary depending on the status of the FRA5097 the moment it has received that program code.

- When an Up or Down sweep is in progress: Measurement will be held.
- When a measurement is stopped: Single or Repeat measurement will start.

- Related program codes

SWEEP MANUAL, SWEEP RANGE, SWEEP RESOLUTION \*\*\*

## ■ **SW**weep range

### ?**SW**weep range

Setup: **SW**weep range <param1>, <param2>

Query: ?**SW**weep range

(Answer) SWEEP RANGE <param1>, <param2>

- General: Sets or inquires the sweep frequency range

- Parameter (when parameters are set)

- param1: Minimum sweep frequency (Hz)
- param2: Maximum sweep frequency (Hz)

Format: NR3

Range: 0.1E-3 to 15E+6 (Hz)

Resolution: 0.1E-3 (Hz)

omit: None changes

- Answer message (when a query is run)

- param1: Current minimum sweep frequency (Hz)
- param2: Current maximum sweep frequency (Hz)

Format: NR3

Range: 0.1E-03 to 15.000000000E+06

Characters: 17

- Example setup

sweep 1, 1e6

Sweep range of 1 Hz to 1 MHz (the sub-header range is omitted)

sweep range „2.2e6

Sets the maximum of a sweep to 2.2 MHz (the minimum will not be changed)

sw 1e3,

Sets the minimum of a sweep to 1 kHz (the maximum will not be changed)

- Related program code

**SW**weep REsolution \*\*\*

## ■ **SW**weep **RE**solution log sweep

### ?**SW**weep **RE**solution log sweep

Setup: **SW**weep **RE**solution log sweep <param>

Query: ?**SW**weep **RE**solution log sweep

(Answer) SWEEP RESOLUTION LOG SWEEP <param>

- General: Sets or inquires the resolution (steps/sweep) of a log sweep
- Parameter (when parameters are set)
  - param: Resolution of a log sweep  
Format: NR1  
Range: 3 to 20000 (steps/sweep)
- Answer message (when a query is run)
  - param: Current resolution of a log sweep  
Format: NR1  
Range: 3 to 20000  
Characters: 6
- Example setup
 

sweep resolution 100	(Log) sweep resolution: 100 steps/sweep
----------------------	---
- Remarks
 

If the sweep resolution, the minimum sweep frequency and the maximum sweep frequency are set to n(steps/sweep)  $f_L$ (Hz) and  $f_H$ (Hz), respectively, the frequency point where a sweep measurement is carried out, will be determined by the following formula.

$$f_L (f_H/f_L)^{0/n} = f_L$$

$$f_L (f_H/f_L)^{1/n}$$

$$\vdots$$

$$f_L (f_H/f_L)^{(n-1)/n}$$

$$f_L (f_H/f_L)^{n/n} = f_H$$

The number of measurement data that is obtained by a sweep will be the set sweep resolution (steps/sweep) plus one.  
This setup will be valid when "SWweep REsolution Mode" is set to 0 or LOGSweep.
- Related program code
 

SWweep REsolution Mode



#### ■ **SW**weep **RE**solution log **D**ecade

#### ?**SW**weep **RE**solution log **D**ecade

Setup: **SW**weep **RE**solution log **D**ecade <param>

Query: ?**SW**weep **RE**solution log **D**ecade

(Answer) SWEEP RESOLUTION LOG DECADE <param>

- General: Sets or inquires the per-digit resolution of a log sweep (steps/decade)
  
- Parameter (when parameters are set)
  - param: Per-digit resolution of a log sweep  
Format: NR1  
Range: 1 to 20000 (steps/decade)
  
- Answer message (when a query is run)
  - param: Current per-digit resolution of a log sweep  
Format: NR1  
Range: 1 to 20000  
Characters: 6
  
- Example setup  
sweep resolution log decade 10 (Log) sweep resolution: 10steps/decade
  
- Remarks  
This setup will be valid when "SWweep REsolution Mode" is set to 1 or LOGDecade.
  
- Related program code  
SWweep REsolution Mode

#### ■ **SW**weep **RE**solution **LI**n sweep

#### ?**SW**weep **RE**solution **LI**n sweep

Setup: **SW**weep **RE**solution **LI**n sweep <param>

Query: ?**SW**weep **RE**solution **LI**n sweep

(Answer) SWEEP RESOLUTION LIN SWEEP <param>

- General: Sets or inquires the resolution of a linear sweep (steps/sweep)
  
- Parameter (when parameters are set)
  - param: Resolution of a linear sweep  
Format: NR1  
Range: 3 to 20000 (steps/sweep)
  
- Answer message (when a query is run)
  - param: Current resolution of a linear sweep  
Format: NR1  
Range: 3 to 20000  
Characters: 6
  
- Example setup  
sweep resolution lin sweep 100      Linear sweep resolution: 100 steps/sweep
  
- Remarks  
This will set the resolution of a sweep that is performed at equal intervals between the maximum and minimum sweep frequencies. The number of measurement data will be the value that was set by this program code plus one.  
This setup will be valid when "SWweep REsolution Mode" is set to 2 or LINSweep.
  
- Related program code  
SWweep REsolution Mode

#### ■ **SW**weep **RE**solution **LI**n **H**z

##### ?**SW**weep **RE**solution **LI**n **H**z

Setup: **SW**weep **RE**solution **LI**n **H**z <param>

Query: ?**SW**weep **RE**solution **LI**n **H**z

(Answer) SWEEP RESOLUTION LIN HZ <param>

- General: Sets or inquires the resolution of a linear sweep (frequency)
  
- Parameter (when parameters are set)
  - param: Resolution of a linear sweep  
Format: NR3  
Range: 0.1E-3 to 15E+6 (Hz)
  
- Answer message (when a query is run)
  - param: Current resolution of a linear sweep  
Format: NR3  
Range: 0.1E-03 to 15.000000000E+6  
Characters: 17
  
- Example setup  
sweep resolution lin hz 1e3                      Sets a sweep measurement per 1 kHz
  
- Remarks  
This setup will be valid when "SWweep RESolution Mode" is set to 3 or LINHz.
  
- Related program code  
SWweep RESolution Mode

■ **SWEEP RESOLUTION MODE**

?**SWEEP RESOLUTION MODE**

Setup: **SWEEP RESOLUTION MODE** <param>

Query: **?SWEEP RESOLUTION MODE**

(Answer) SWEEP RESOLUTION MODE <param>

- General: Sets or inquires the type of sweep resolution

- Parameter (when parameters are set)

- param: Type of sweep resolution

Format: NR1 or string

NR1	String	Description
0	<b>LOGSWEEP</b>	Log sweep Setup by SWEEP RESOLUTION log sweep is valid
1	<b>LOGDECADE</b>	Log sweep Setup by SWEEP RESOLUTION log Decade is valid
2	<b>LINSWEEP</b>	Linear sweep Setup by SWEEP RESOLUTION LIn sweep is valid
3	<b>LINHZ</b>	Linear sweep Setup by SWEEP RESOLUTION LIn Hz is valid

- Answer message (when a query is run)

- param: Current status of a sweep measurement

Format: NR1 (characters: 2) or string (to be set by **SETP MNEMONIC**)

Answer format		Description
NR1	String	
0	LOGSWEEP	Log sweep Setup by SWEEP RESOLUTION log sweep is valid
1	LOGDECADE	Log sweep Setup by SWEEP RESOLUTION log Decade is valid
2	LINSWEEP	Linear sweep Setup by SWEEP RESOLUTION LIn sweep is valid
3	LINHZ	Linear sweep Setup by SWEEP RESOLUTION LIn Hz is valid

- Example setup

sweep resolution mode 0

Log sweep. Enables the value set by SWEEP RESOLUTION log sweep

- Remarks

The following four types of settings are available for a sweep resolution:

- SWEEP RESOLUTION LOG SWEEP (Log sweep. To be set by the number of steps in a sweep range)
- SWEEP RESOLUTION LOG DECADE (Log sweep. To be set by the number of steps per digit of frequency)
- SWEEP RESOLUTION LIN SWEEP (Linear sweep. To be set by the number of steps in a sweep range)
- SWEEP RESOLUTION LIN HZ (Linear sweep. To be set by the variation range of a frequency)

Individual settings can be made by the corresponding program codes, and the set values will be stored internally in the FRA5097. When a sweep measurement is actually carried out, the sweep resolution type set by the program code "SWEEP RESOLUTION MODE" will be selected. The set values for the remaining three sweep resolution types will be stored as are.

- Related program codes

SWEEP RESOLUTION LOG SWEEP, SWEEP RESOLUTION LOG DECADE,  
SWEEP RESOLUTION LIN SWEEP, SWEEP RESOLUTION LIN HZ, SWEEP RANGE

■ **SW**weep Slow mode

?**SW**weep Slow mode

Setup: **SW**weep Slow mode <param>

Query: ?**SW**weep Slow mode

(Answer) SWEEP SLOW MODE <param>

- General: Sets or inquires the operation mode of a low-speed & high-density sweep
- Parameter (when parameters are set)
  - param: Operation mode of a low-speed, high density sweep (SlowSweep)
  - Format: NR1 or string

NR1	String	Description
0	<b>Off</b>	Function OFF
1	<b>Auto</b>	Auto mode
2	<b>Manual</b>	Manual mode

- Answer message (when a query is run)
  - param: Operation mode of the current low-speed, high density sweep
  - Format: NR1 (characters: 2) or string (to be set by **SE**tup **M**nemonic)

Answer format		Description
NR1	String	
0	OFF	Function OFF
1	AUTO	Auto mode
2	MANUAL	Manual mode

- Example setup
 

sweep slow mode 1	Sets the low-speed & high-density sweep of
	AUTO mode
- Related program codes
 

SWweep Slow Target, SWweep Slow Variation \*\*\*

■ **SWEEP Slow Target**

?**SWEEP Slow Target**

Setup: **SWEEP Slow Target** <param>

Query: ?**SWEEP Slow Target**

(Answer) SWEEP SLOW TARGET <param>

- General: Sets or inquires the reference channel of a low-speed, high-density sweep
- Parameter (when parameters are set)
  - param: Reference channel of a low-speed, high density sweep
  - Format: NR1 or string

NR1	String	Description
1	<b>CH1</b>	Reference channel: CH1
2	<b>CH2</b>	Reference channel: CH2

- Answer message (when a query is run)
  - param: Reference channel of the current low-speed, high density sweep
  - Format: NR1 (characters: 2) or string (to be set by **SEtup Mnemonic**)

Answer format		Description
NR1	String	
1	CH1	Reference channel: CH1
2	CH2	Reference channel: CH2

- Example setup
 

sweep slow target ch1	Refers to CH1 level and starts a low-speed & high-density sweep
-----------------------	---
- Related program codes
 

SWEEP Slow mode, SWEEP Slow Variation \*\*\*

## ■ **SW**weep **S**low **V**ariation **L**ogr

### ?**SW**weep **S**low **V**ariation **L**ogr

Setup: **SW**weep **S**low **V**ariation **L**ogr <param>

Query: ?**SW**weep **S**low **V**ariation **L**ogr

(Answer) SWEEP SLOW VARIATION LOGR <param>

- General: Sets or inquires the target variation for a low-speed & high-density sweep (measuring gain: dB)
  
- Parameter (when parameters are set)
  - param: Target variation (measuring gain: dB)  
Format: NR3  
Range: 0 to 1000 (dB)
  
- Answer message (when a query is run)
  - param: Current target variation (measuring gain: dB)  
Format: NR3  
Range: 0.00E+00 to 1000E+00 (dB)  
Characters: 9
  
- Example setup

sweep slow variation logr 0.1	Starts a low-speed & high-density sweep when the measuring gain has changed by 0.1 dB or more than the last value measured
-------------------------------	--
  
- Remarks

This setup will be valid when "SWweep Slow Variation Mode" is set to 0 or Logr.
  
- Related program codes

SWweep Slow mode, SWweep Slow Target, SWweep Slow Variation Mode



## ■ **SW**weep **S**low **V**ariation **R**

### ?**SW**weep **S**low **V**ariation **R**

Setup: **SW**weep **S**low **V**ariation **R** <param>

Query: ?**SW**weep **S**low **V**ariation **R**

(Answer) SWEEP SLOW VARIATION R <param>

- General: Sets or inquires the target variation (measuring voltage: Vrms) for a low-speed & high-density sweep
- Parameter (when parameters are set)
  - param: Target variation (measuring voltage: Vrms)  
Format: NR3  
Range: 0 to 1.0E+9 (Vrms)
- Answer message (when a query is run)
  - param: Current target variation (measuring voltage: Vrms)  
Format: NR3  
Range: 0.00E+00 to 1.00E+09 (Vrms)  
Characters: 9
- Example setup

sweep slow variation r 1.5	Starts a low-speed & high-density sweep when the measuring voltage of the reference channel has changed by 1.5 Vrms or more than the last value measured
----------------------------	--
- Remarks

This setup will be valid when "SWweep Slow Variation Mode" is set to 1 or R.
- Related program codes

SWweep Slow mode, SWweep Slow Target, SWweep Slow Variation Mode

#### ■ **SW**weep **S**low **V**ariation **T**heta

#### ?**SW**weep **S**low **V**ariation **T**heta

Setup: **SW**weep **S**low **V**ariation **T**heta <param>

Query: ?**SW**weep **S**low **V**ariation **T**heta

(Answer) SWEEP SLOW VARIATION THETA <param>

- General: Sets or inquires the target variation (phase: deg) for a low-speed & high-density sweep
  
- Parameter (when parameters are set)
  - param: Target variation (phase: deg)  
Format: NR3  
Range: 0 to 180 (deg)
  
- Answer message (when a query is run)
  - param: Current target variation (phase: deg)  
Format: NR3  
Range: 0.00E+00 to 180E+00  
Characters: 9
  
- Example setup

sweep slow variation theta 0.5	Starts a low-speed & high-density sweep when the phase of the reference channel has changed by 0.5 deg or more than the last value measured
--------------------------------	---
  
- Remarks

This setup will be valid when "SWweep Slow Variation Mode" is set to 2 or Theta.
  
- Related program codes

SWweep Slow mode, SWweep Slow Target, SWweep Slow Variation Mode

#### ■ **SWEEP Slow Variation A**

#### ?**SWEEP Slow Variation A**

Setup: **SWEEP Slow Variation A** <param>

Query: **?SWEEP Slow Variation A**

(Answer) SWEEP SLOW VARIATION A <param>

- General: Sets or inquires the target variation (real voltage: Vrms) for a low-speed, high density sweep
  
- Parameter (when parameters are set)
  - param: Target variation (real voltage: Vrms)  
Format: NR3  
Range: 0.00E+00 to 1.00E+9 (Vrms)
  
- Answer message (when a query is run)
  - param: Current target variation (real voltage: Vrms)  
Format: NR3  
Range: 0.00E+00 to 1.00E+09 (Vrms)  
Characters: 9
  
- Example setup

sweep slow variation a 5	Starts a low-speed & high-density sweep when the real voltage of the reference channel has changed by 5 Vrms or more than the last value measured
--------------------------	---
  
- Remarks

This setup will be valid when "SWEEP Slow Variation Mode" is set to 3 or A.
  
- Related program codes

SWEEP Slow mode, SWEEP Slow Target, SWEEP Slow Variation Mode

#### ■ **SWEEP Slow Variation B**

##### ?**SWEEP Slow Variation B**

Setup: **SWEEP Slow Variation B** <param>

Query: **?SWEEP Slow Variation B**

(Answer) SWEEP SLOW VARIATION B <param>

- General: Sets or inquires the target variation (imaginary voltage: Vrms) for a low-speed & high-density sweep
- Parameter (when parameters are set)
  - param: Target variation (imaginary voltage: Vrms)  
Format: NR3  
Range: 0.00E+00 to 1.00E+9 (Vrms)
  - Answer message (when a query is run)
    - param: Current target variation (imaginary voltage: Vrms)  
Format: NR3  
Range: 0.00E+00 to 1.00E+09 (Vrms)  
Characters: 9
- Example setup

sweep slow variation b 1.2	Starts a low-speed & high-density sweep when the imaginary voltage of the reference has changed by 1.2 Vrms or more than the last value measured
----------------------------	--
- Remarks

This setup will be valid when "SWEEP Slow Variation Mode" is set to 4 or B.
- Related program codes

SWEEP Slow mode, SWEEP Slow Target, SWEEP Slow Variation Mode

## ■ **SW**weep Slow Variation Mode

### ?**SW**weep Slow Variation Mode

Setup: **SW**weep Slow Variation Mode <param>

Query: ?**SW**weep Slow Variation Mode

(Answer) SWEEP SLOW VARIATION MODE <param>

- General: Sets or inquires the target variation type for a low-speed & high-density sweep

- Parameter (when parameters are set)

- param: Target variation type for a low-speed & high-density sweep (SlowSweep)

Format: NR1 or string

NR1	String	Description
0	Logr	Setup by SWEEP Slow Variation Logr is valid
1	R	Setup by SWEEP Slow Variation R is valid
2	Theta	Setup by SWEEP Slow Variation Theta is valid
3	A	Setup by SWEEP Slow Variation A is valid
4	B	Setup by SWEEP Slow Variation B is valid

- Answer message (when a query is run)

- param: Target variation type for the current low-speed & high-density sweep

Format: NR1 (characters: 2) or string (to be set by **SE**tup **M**nemonic)

Answer format		Description
NR1	String	
0	LOGR	Setup by SWEEP Slow Variation Logr is valid
1	R	Setup by SWEEP Slow Variation R is valid
2	THETA	Setup by SWEEP Slow Variation THETA is valid
3	A	Setup by SWEEP Slow Variation A is valid
4	B	Setup by SWEEP Slow Variation B is valid

- Example setup

sweep slow variation mode 0      Enables the value set by "SWEEP Variation Logr"

- Related program codes

SWEEP Slow mode, SWEEP Slow Target

#### ■ ?Error

Query: ?Error

(Answer) ERROR <param>

- General: Inquires error codes
- Answer message (when a query is run)
  - param: Error code
  - Format: NR1, 3 characters

- Example setup

?error

Inquires an error code

- Remarks

An error code will be output for the last error that occurred. If there is no error, then "0" will be output.

For error codes and their descriptions, refer to "**FRA5097 INSTRUCTION MANUAL**".

If this query is run, then the error code will be cleared.

#### ■ ?IDentifier

Query: ?IDentifier

(Answer) IDENTIFIER <param>

- General: Inquires the model name

- Answer message (when a query is run)

- param: Model name

Format: String "FRA5097"

- Example setup

?identifier

Inquires the model name

#### ■ ?OVerload

Query: ?OVerload

(Answer) OVERLOAD <param>

- General: Inquires the detection status of overload input

- Answer message (when a query is run)

- param: Detection status of overload input

Format: NR1, 2 characters

param	Description
0	No overload
1	Only CH1 is overloaded
2	Only CH2 is overloaded
3	CH1 and CH2 are overloaded

- Example setup

?over

Inquires the overload status

- Remarks

In response to a query using this program code, the overload status at the moment that the query has been received, will be returned. However, no previous overload input will be returned.



## ■ SRqenable

### ?SRqenable

Setup: **SRqenable** <param>

Query: **?SRqenable**

(Answer) SRQENABLE <param>

- General: Sets or inquires the enabled status of SRQ transmission

- Parameter (when parameters are set)

- param: Factors that enable SRQ transmission  
Format: NR1 Range: 0 to 47

- Answer message (when a query is run)

- param: Current factor that enables SRQ transmission  
Format: NR1, 3 characters Range: 0 to 47

- Example setup

srq 4	Transmits an SRQ when overload input has occurred
-------	---

- Remarks

An SRQ will be transmitted when any of the following factors has taken place. Here a set value is assumed to be a binary code and the bit to be 1. The setting is made in decimal code. An SRQ transmission will be enabled when at least one of the following factors has occurred.

- bit5(+32): Error occurred
- bit4(+16): (Unused)
- bit3(+8): Output ready (query, data transfer etc.)
- bit2(+4): Overload input (overload detected)
- bit1(+2): Measure end
- bit0(+1): Sweep end

For example, to transmit an SRQ when an error has occurred or a sweep ends, 32+1=33 should be set.

#### ■ ?SStatus

Query: ?SStatus

(Answer) STATUS <param>

- General: Outputs the status byte
- Answer message (when a query is run)
  - param: Status byte
  - Format: NR1, 4 characters

- Example setup

?st

Reads the status byte

- Remarks

The status byte identical to the serial poll byte will be output in decimal codes. However, bit3 (Output ready) will be constantly 0.

For a description of the status byte, refer to "**Table 2-1 Status Byte**".

#### ■ ?Version

Query: ?Version

(Answer) VERSION <param>

- General: Outputs the software versionp
  
- Answer message (when a query is run)
  - param: Software version
  - Format: NR2. If the number of characters is less than 5, then they will be placed to left and a space(s) will fill in for the missing character(s).
  
- Example setup
  - ?version Outputs the version
  - (Example answer) VERSION 1.00

#### ■ ?Learn

Query: ?Learn

(Answer) <param> (block delimiter)  
<param> (block delimiter)  
:  
<param> (delimiter)

- General: Output of all FRA5097 setting items

- Answer message (when a query is run)

- param: FRA5097 setup status  
Format: String

- Example setup

?learn

(Example answer) CALCULATION ARITHMETIC 0,0,0,0,0,0  
CALCULATION JW 1,0,0  
:

- Remarks

Response messages are issued for all queries that have corresponding setup messages. A header is applied to each parameter. Responses are not issued for SEtup Date or SEtup Time. The answer strings to be output will use the format that the FRA5097 can receive them as setup messages.

For the list of setup messages, refer to "**Table 3-2 Setup Message List**".

## 4. Notes for Programming

- a) If the FRA 5097 is designated as a talker without requesting any output (without sending any query message), then an empty block will be returned.
- b) To perform a hold measurement using "Measure Repeat Off ; SWEEP MEASURE Hold" via the GPIB/USB and then read the data, follow these steps:
  - 1) Use "SRQenable 2 to enable the transmission of an SRQ (service request), which is intended for the end of a measurement.
  - 2) Start a hold measurement using "Measure Repeat Off ; SWEEP MEASURE Hold."
  - 3) Wait for RQS (bit6) and the end of measurement (bit1) to be set by means of a serial poll.
  - 4) Use "?DATA Read CUrrent" to inquire and read the data.
- c) If the transmission of a program code etc. is interrupted using the controller before it is completed, an error may occur to the subsequent program code. When a program code transmission is interrupted in this manner, execute a device clear.
- d) Assume that a query message is sent via the controller. The FRA 5097 is then designated as a talker and a data transfer is started. If the controller then interrupts the reception of data in progress, the FRA 5097 may freeze while waiting for a transmission. When a data transfer is interrupted in this manner, execute a device clear.
- e) Assume that a query message is sent via the controller. Another query message is then sent without designating the FRA 5097 as a talker. In such a case, the answer to the latter query may directly follow that to the former query (without any delimiter being placed in between).  
In this manner, when a query message is sent that does not designate the FRA 5097 as a talker, execute a device clear.
- g) If a query message is sent immediately after an error has occurred in the GPIB, a null character string may be returned. In such a case, execute a device clear after the error has occurred.



## **5. Sample Program**

<b>5.1 Overview of Sample Program.....</b>	<b>5-2</b>
<b>5.2 Setup and Query.....</b>	<b>5-3</b>
<b>5.3 Setting a Sweep Frequency Range and Sweep Measurement.....</b>	<b>5-5</b>
<b>5.4 Transfer of Measurement Data to Controller (1) .....</b>	<b>5-7</b>
<b>5.5 Transfer of Measurement Data to Controller (2) .....</b>	<b>5-9</b>

### 5.1 Overview of Sample Program

This sections describes some examples of remote controlling that uses the GPIB interface.

The equipment configuration used is as follows:

- Computer: IBM PC/AT compatible
- OS: Microsoft Windows 2000
- Language: Microsoft Visual Basic 6.0 or later
- GPIB controller: NF Corporation USB488  
(USB-GPIB conversion adapter)

The description here will focus on the following four types of remote control:

**a) Setup and Query**

This is the simplest type of remote control. After initialization, the amplitude of the oscillator is set, and then it is confirmed by running a query. In addition to GPIB, an example for USB is also shown.

**b) Setting a Sweep Frequency Range and Sweep Measurement**

After the maximum and minimum sweep frequencies are set, a sweep measurement (Up Sweep) is started, and it is then waited until the sweep ends.

**c) Transfer of Measurement Data to Controller (1)**

The measurement data obtained by a sweep measurement is transferred to the controller in ASCII format.

**d) Transfer of Measurement Data to Controller (2)**

The measurement data obtained by a single measurement is transferred to the controller in ASCII format.

In each of these cases, an error check or a similar step is omitted. When you actually engage in programming, give consideration to the steps for error processing or initialization.



### 5.2 Setup and Query

When the button is pressed, the amplitude of the oscillator is set, and then the results of a query will be displayed.

The necessary initialization is performed with the Form\_Load.

Here, the device descriptor (Dev) is opened with the timeout set to 300 ms, GPIB address to 2, EOI to ON, and terminator to LF. With the SetQueryBtn, a command for setting the amplitude of oscillator will be output to the device (FRA5097) using the character string that was entered in SetValueTxt, as a parameter.

With the Form\_Unload, the equipment is put back in the local status.

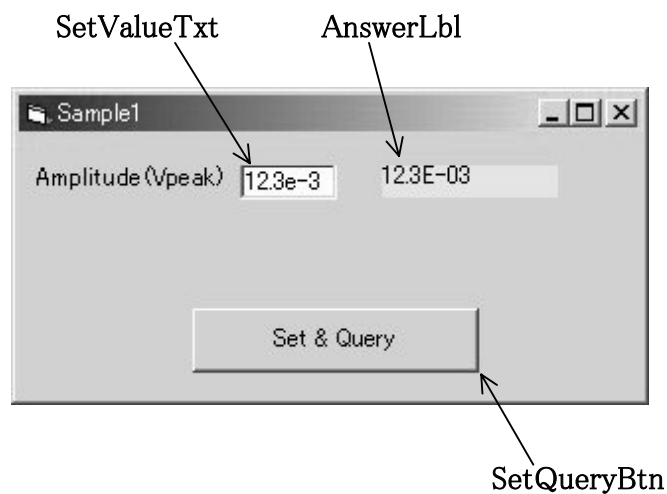

#### GPIB example

```

Const ADR As Integer = 2

Private Sub Form_Load()
    Dim stat As Integer
    initialize 0, 0
    transmit "DCL", stat
End Sub

Private Sub Form_Unload(Cancel As Integer)
    Dim stat As Integer
    transmit "UNL LSTEN " & CStr(ADR) & " GTL", stat 'Go to Local
End Sub

Private Sub SetQueryBtn_Click()
    Dim rdbuf As String
    Dim j As Integer
    Dim stat As Integer
    send ADR, "OScillator Amplitude " & SetValueTxt.Text, stat ' Setting of amplitude
    send ADR, "?OScillator Amplitude ", stat ' Query on amplitude
    enter rdbuf, 256, j, ADR, stat ' Reception of answer message
    AnswerLbl = rdbuf
End Sub
    
```

### USB example

```

Const serial As String = "0012045"      'FRA5097 serial No.
Const MAX_CNT = 200
Const idVendor As String = "0x0D4A::"   'NF corp.
Const idProduct As String = "0x000A::"  'FRA5097 product No.
Dim dfltRM As ViSession
Dim sesn As ViSession

Private Sub Form_Load()
Dim stat As ViStatus
Const timeout As Integer = 1000        'timeout=1000(ms)
stat = viOpenDefaultRM(dfltRM)
If (stat < VI_SUCCESS) Then
    Exit Sub
End If
stat = viOpen(dfltRM, "USB0::" & idVendor & idProduct & _
              serial & "::INSTR", VI_NULL, VI_NULL, sesn)
stat = viSetAttribute(sesn, VI_ATTR_TMO_VALUE, timeout)
End Sub

Private Sub Form_Unload(Cancel As Integer)
Dim stat As ViStatus
stat = viGpibControlREN(sesn, VI_GPIB_REN_DEASSERT)
stat = viClose(sesn)
stat = viClose(dfltRM)
End Sub

Private Sub SetQueryBtn_Click()
Dim stat As ViStatus
Dim retCount As Long
Dim buffer As String * MAX_CNT
buffer = "OScillator Amplitude " & SetValueTxt & vbLf
stat = viWrite(sesn, buffer, Len(buffer), retCount)      ' Setting of amplitude
wait (0.5)
buffer = "?OScillator Amplitude" & vbLf
stat = viWrite(sesn, buffer, Len(buffer), retCount)      ' Query on amplitude
stat = viRead(sesn, buffer, MAX_CNT, retCount)           ' Reception of answer message
AnswerLbl.Caption = Left$(buffer, retCount)
End Sub

Private Sub wait(t As Double)
Dim tm As Double
tm = Timer
While ((Timer - tm) < t)
    DoEvents
Wend
End Sub
    
```

### 5.3 Setting a Sweep Frequency Range and Sweep Measurement

When the button is pressed, a sweep frequency range is set and a sweep measurement will be started. Then, it will be waited until the sweep terminates.

A sweep range will be set if the button is pressed after entering the upper- and minimum sweep frequencies. When the status label (StsLbl) has switched from " Sweep in progress" to "Sweep End", then the sweep measurement is completed.

If the set maximum or minimum sweep frequency is modified, then the status label (StsLbl) will be cleared.

A sweep measurement in progress is identified by bit0 of the status byte that was obtained through a serial poll. To obtain the status byte, the timer function (Timer) of Visual Basic is used to execute a serial poll every two seconds. If a serial poll is performed without applying this weight, the measuring operation of the FRA5097 will become extremely slow, since it will cause the output of the status byte to be requested at frequent intervals.

If bit0 of the status byte becomes 1, the device will determine that the sweep is completed, and then the measurement will terminate after the status label is switched to " Sweep End".

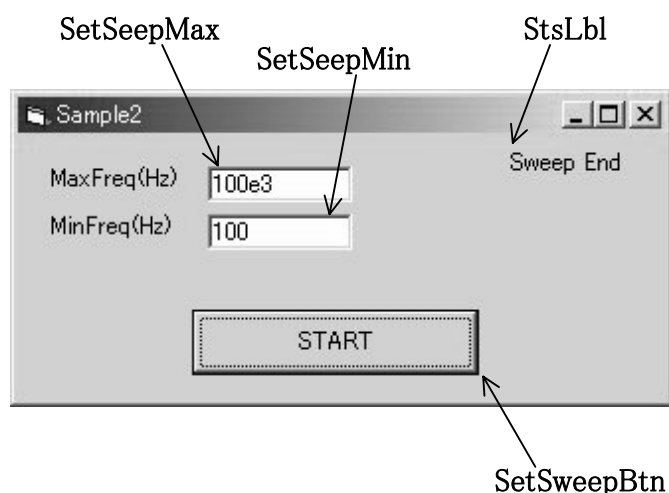

(Contd.)

### 5.3 Setting a Sweep Frequency Range and Sweep Measurement

```
Const ADR As Integer = 2

Private Sub Form_Load()
    Dim stat As Integer
    initialize 0, 0
    transmit "DCL", stat
End Sub

Private Sub Form_Unload(Cancel As Integer)
    Dim stat As Integer
    transmit "UNL LSTEN " & CStr(ADR) & " GTL", stat 'Go to Local
End Sub

Private Sub SetSweepBtn_Click()
    Dim rdbuf As String
    Dim j As Integer
    Dim stat As Integer
    Dim stb As Integer
    Dim tm As Long
    StsLbl.Caption = "Sweep in Progress"
    DoEvents
    send ADR, "SWEEP range " & SetSweepMin.Text & ", " & SetSweepMax.Text, stat
    send ADR, "SWEEP MEASURE Up", stat
    stb = 0
    tm = Timer
    While ((stb And &H1) = 0)           ' Waits for bit0=1 of status byte
        While ((Timer - tm) < 2)
            Wend                       ' Waits two seconds
            tm = Timer
            spoll ADR, stb, stat        ' Serial poll
        Wend
    StsLbl.Caption = "Sweep End"
End Sub

Private Sub SetSweepMax_Change()
    StsLbl.Caption = ""                ' Status label cleared
End Sub

Private Sub SetSweepMin_Change()
    StsLbl.Caption = ""                ' Status label cleared
End Sub
```

### 5.4 Transfer of Measurement Data to Controller (1)

When the button is pressed, the measurement data of the current tag in the FRA5097 will be loaded and displayed in ASCII format.

When the "READ" button is pressed, the current tag number of the FRA5097 will be loaded, followed by the data block count of the current tag.

All data blocks of the current tag number will be read out when the data transfer format is set to ASCII and the data to be transferred is set to any of the following:

Frequency (Hz), Gain (dB), Phase (deg),

Each time one data block is sent, a delimiter (CR or CR+LF to be set in FRA5097) will be added, so that data loading will continue for as many times as the number of data blocks received.

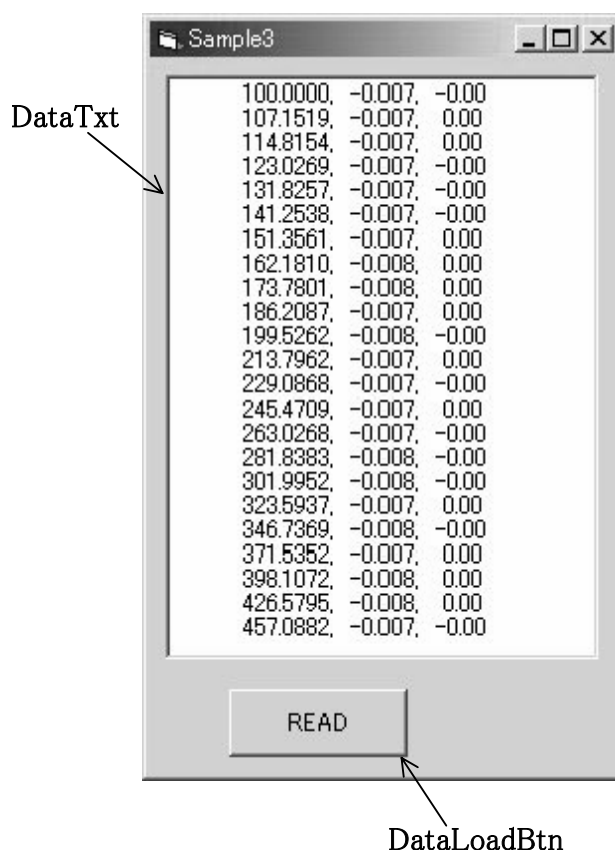

(Contd.)

## 5.4 Transfer of Measurement Data to Controller (1)

```
Const ADR As Integer = 2

Private Sub DataLoadBtn_Click()
    Dim rdbuf As String
    Dim j As Integer
    Dim stat As Integer
    Dim tag As Integer
    Dim datasize As Integer
    DataTxt.Text = ""
    DoEvents
    send ADR, "?DATA CURRENT", stat
    enter rdbuf, 256, j, ADR, stat
    tag = Val(rdbuf) ' Current tag number
    send ADR, "?DATA READ SIZE", stat
    enter rdbuf, 256, j, ADR, stat
    datasize = Val(rdbuf) + 1 ' Block count of current tag
    send ADR, "DATA TEMPLATE STRING, SWEEP, LOGR, THETA", stat
    ' Designation of transfer format
    send ADR, "?DATA READ DATA " & Str$(tag) & ",0," & Str$(datasize - 1), stat
    ' Start of data transfer

    While (0 <= datasize)
        enter rdbuf, 256, j, ADR, stat ' One block of data transfer by one round of
        ' reception
        DataTxt.Text = DataTxt.Text & rdbuf & Chr$(13) & Chr$(10)
        datasize = datasize - 1
    Wend
End Sub

Private Sub Form_Load()
    Dim stat As Integer
    initialize 0, 0
    transmit "DCL", stat
End Sub

Private Sub Form_Unload(Cancel As Integer)
    Dim stat As Integer
    transmit "UNL LSTEN " & CStr(ADR) & " GTL", stat 'Go to Local
End Sub
```

**5.5 Transfer of Measurement Data to Controller (2)**

A single measurement will be carried out. Then, the measurement data will be loaded and displayed in ASCII format after the end of the measurement is waited.

When the "MEASURE" button is pressed, a single measurement will be started after the data transfer format and the data to be transferred are set. The measurement data will be loaded and displayed after the end of the measurement is confirmed by "?SWEEP MEasure."

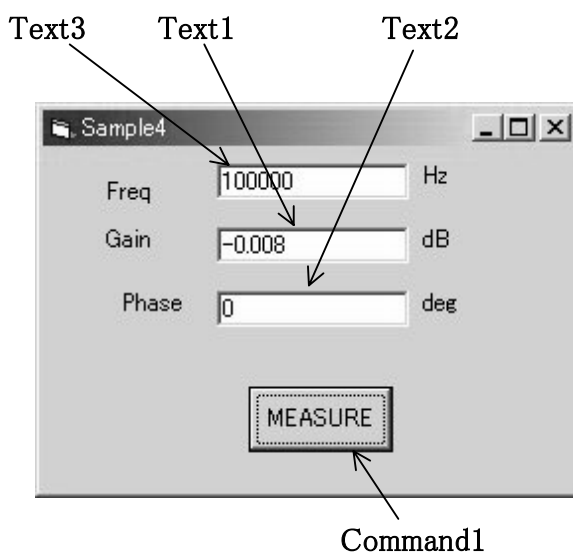

(Contd.)

## 5.4 Transfer of Measurement Data to Controller (1)

```
Const adr As Integer = 2

Private Sub Command1_Click()
    Dim stat As Integer
    Dim rdbuf As String
    Dim j As Integer
    Dim tm As Long
    Dim sweep As Integer
    send adr, "DATA Template String,Sweep,LOGR,Theta", stat
    send adr, "SWEEP MEASURE HOLD", stat ' Start of SINGLE Measurement
' Waits for measurement to end
    tm = Timer
    sweep = 1
    While (sweep <> 0)
        While (Abs(Timer - tm) < 1)
            Wend
            send adr, "?SWEEP MEASURE", stat
            enter rdbuf, 256, j, adr, stat
            sweep = Val(rdbuf)
        Wend
        send adr, "?DATA READ CURRENT", stat ' Query on data
        enter rdbuf, 256, j, adr, stat ' Reception of measurement data
        Text3.Text = Left$(rdbuf, 17)
        Text1.Text = Mid$(rdbuf, 19, 8)
        Text2.Text = Mid$(rdbuf, 28)
    End Sub

Private Sub Form_Load()
    Dim stat As Integer
    initialize 0, 0
    transmit "DCL", stat
End Sub

Private Sub Form_Unload(Cancel As Integer)
    Dim stat As Integer
    transmit "UNL LSTEN" & CStr(adr) & "GTL", stat 'GTL
End Sub
```



## **6. Specifications**

<b>6.1</b>	<b>Interface Functions .....</b>	<b>6-2</b>
<b>6.2</b>	<b>GPIB Bus Driver .....</b>	<b>6-2</b>
<b>6.3</b>	<b>Applied Codes .....</b>	<b>6-2</b>
<b>6.4</b>	<b>Answers to Interface Messages .....</b>	<b>6-3</b>
<b>6.5</b>	<b>Multi-line Interface Messagess .....</b>	<b>6-4</b>

## 6.1 Interface Functions

### 6.1 Interface Functions

#### Interface Functions

Function	Subset	Description
Source handshake	SH1	All send handshake functions available
Acceptor handshake	AH1	All receive handshake functions available
Talker	T6	Basic talker functions; and talker cancellation by MLA
Listener	L4	Basic listener functions; and listener cancellation by MTA
Service request	SR1	All service request functions available
Remote/local	RL1	All remote and local functions available
Parallel poll	PP0	No parallel poll function available
Device clear	DC1	All device clear functions available
Device trigger	DT0	No device trigger function available
Controller	C0	No controller function available

### 6.2 GPIB Bus Driver

#### Bus Driver Specification

Data bus	DIO1 to 8	Open collector
Handshake bus	NRFD, NDAC, DAV	Open collector Tri-state
Control bus	SRQ EOI	Open collector Tri-state

### 6.3 Applied Codes

When designated as a listener, the FRA5097 will accept ISO 7bit codes (JIS/ASCII) except for the reception of binary format data, and will ignore any MSB of 8bit data (parity etc.). Program codes are case-independent, so that a program code either in uppercase or lowercase will be interpreted and executed identically.

Control characters will be ignored, except <CR>, <LF> and <TAB> (hexadecimal codes: 0 to 8, B, D to 1F, and 7F).

When designated as a talker, the FRA5097 will accept ISO 7bit codes (JIS/ASCII) without parity (8bit data MSB = 0), except for the transmission of binary format data.

All alphabetical symbols in a program code will be transmitted in uppercase.

When sending binary format data, the FRA5097 will accept all 8bit patterns and use the standard IEEE floating-point format (including all control codes). Refer to "**3.2 Data Transfer**" for information on floating-point formats.

6.4 Answers to Interface Messages

Answers to Interface Messages

IFC	<ul style="list-style-type: none"><li>· Initializes the interface.</li><li>· Resets the listener/talker designation.</li></ul>
DCL and SDC	<ul style="list-style-type: none"><li>· Clears the I/O buffer.</li><li>· Clears an error.</li><li>· Resets the transmission of SRQ, and resets the factor bit in status byte.</li><li>· Disables the transmission of SRQ.</li><li>· Disables the header/mnemonic output.</li><li>· Resets the data I/O format to default.</li></ul>
LLO	<ul style="list-style-type: none"><li>· Disables the LOCAL key on the panel.</li></ul>
GTL	<ul style="list-style-type: none"><li>· Changes to the local status.</li></ul>

6.5 Multi-line Interface Messages

*2					b7	0	*1	0	MSG	0	MSG	1	MSG	1	MSG	1	MSG	1	MSG										
					b6	0	MSG	0	MSG	1	MSG	0	MSG	0	MSG	1	MSG	1	MSG										
					b5	0	MSG	1	MSG	0	MSG	0	MSG	1	MSG	0	MSG	1	MSG										
b4	b3	b2	b1	Column	0		1		2		3		4		5		6		7										
				ROW																									
0	0	0	0	0	NUL		DLE		SP	↑	0	↑	@	↑	P	↑	`	↑	p	↑									
0	0	0	1	1	SOH	GTL	DC1	LLO	!	1	↑	A	↑	Q	↑	a	↑	q	↑										
0	0	1	0	2	STX		DC2		"	2	↑	B	↑	R	↑	b	↑	r	↑										
0	0	1	1	3	ETX		DC3		#	3	↑	C	↑	S	↑	c	↑	s	↑										
0	1	0	0	4	EOT	SDC	DC4	DCL	\$	4	↑	D	↑	T	↑	d	↑	t	↑										
0	1	0	1	5	ENQ	*3 PPC	NAK	PPU	%	5	↑	E	↑	U	↑	e	↑	u	↑										
0	1	1	0	6	ACK		SYN		&	6	↑	F	↑	V	↑	f	↑	v	↑										
0	1	1	1	7	BEL		ETB		'	7	↑	G	↑	W	↑	g	↑	w	↑										
1	0	0	0	8	BS	GET	CAN	SPE	(	8	↑	H	↑	X	↑	h	↑	x	↑										
1	0	0	1	9	HT	TCT	EM	SPD	)	9	↑	I	↑	Y	↑	i	↑	y	↑										
1	0	1	0	10	LF		SUB		*	:	↑	J	↑	Z	↑	j	↑	z	↑										
1	0	1	1	11	VT		ESC		+	;	↑	K	↑	[	↑	k	↑	{	↑										
1	1	0	0	12	FF		FS		,	<	↑	L	↑	*4	↑	l	↑		↑										
1	1	0	1	13	CR		GS		-	=	↑	M	↑	]	↑	m	↑	}	↑										
1	1	1	0	14	SO		RS		.	>	↑	N	↑	^	↑	n	↑	~	↑										
1	1	1	1	15	SI		US		/	?	↑	UNL	↑	O	↑	o	↑	DEL	↑										
					Address Command Group (ACG)					Universal Command Group (UCG)					Listener Address Group (LAG)					Talker Address Group (TAG)									
										Primary Command Group (PCG)										Secondary Command Group (SCG)									

Note: \*1 MSG is an interface message

\*2 b1=DIO1 . . . b7=DIO7. DIO8 is not used.

\*3 Involves a secondary command

\*4 “\” in IEC standard; “¥” in JIS

GTL: Go To Local

SDC: Selected Device Clear

PPC: Parallel Poll Configure

GET: Group Execute Trigger

TCT: Take Control

LLO: Local Lockout

DCL: Device Clear

PPU: Parallel Poll Unconfigure

SPE: Serial Poll Enable

SPD: Serial Poll Disable

UNL: Unlisten

UNT: Untalk

If there are any misplaced or missing pages, we will replace the manual. Contact the sales representative.

NOTES:

- Reproduction of the contents of this manual is forbidden by applicable laws.
- The contents of this manual may be revised without notice.
- Information provided in this manual is intended to be accurate and reliable. However, we assume no responsibility for any damage regarding the contents of this manual.
- We assume no responsibility for influences resulting from the operations in this manual.

Copyright 2006 - 2010, **NF CORPORATION**

FRA5097 Frequency Response Analyzer GPIB/USB Instruction Manual

**NF CORPORATION**

3-20 Tsunashima Higashi 6-chome, Kohoku-ku. Yokohama-shi  
223-8508, JAPAN

Phone: 81-45-545-8128 Fax: 81-45-545-8187





