



HIGH SPEED BIPOLAR AMPLIFIER

HSA4012 / HSA4014

HSA4051 / HSA4052

OPERATION MANUAL

D : 509647 - 1

HSA4012/14
HSA4051/52
HIGH SPEED BIPOLAR AMPLIFIER
Operation Manual

Foreword

Thank you very much for procuring HSA4012/14 1 MHz Bipolar Power Supply; HSA4051/52 500 kHz Bipolar Power Supply. At the outset, please take a few minutes to read the Safety Precautions indicated in this manual in order to use HSA4012/14/51/52 safely and correctly.

- **Warning and Caution notices**

The following Warning and Caution notices appear in this manual. These must be observed in order to protect both the user from physical harm and the equipment from damage.

 **WARNING**

Risk of serious and possibly fatal physical injury from electric shock or other cause.

 **CAUTION**

Risk of damage to the equipment.

- **Manual composition**

Please read Section 1 before using the equipment for the first time.

Section 1 Overview

Describes an outline, features, applications, functions and an outline of the principle of operation.

Section 2 Preparation

Required preparatory work before installing and operating the equipment.
Be sure to read this section.

Section 3 Description of Panel and Basic Operations

Describes the functions, operations and basic operations of the dials on the panel.
Read while operating the equipment.

Section 4 Applications

Expanded operations are described.

Section 5 Maintenance

Describes the methods of storage, repacking, transportation and corrective measures when abnormalities occur.

Section 6 Specifications

Equipment specifications (functions and performance) are described.

Safety Precautions

Observe the following warnings and cautions in order to use this equipment safely. No responsibility or warranty is assumed for damages arising from use in a manner contrary to these warnings and cautions.

HSA4012/14/51/52 belongs to Class I of insulation ratings by IEC standards (equipped with a protective grounding terminal).

- **Observe text instructions**

This manual has been compiled in order to enable safe operation and use of HSA4012/14/51/52. Be sure to read this manual before using the equipment.

Items designated by Warning advise of serious physical hazards. Be sure to observe these carefully.

- **Be sure to connect ground**

To prevent electric shock, securely connect the equipment to a ground.

Be sure to properly connect the ground. By connecting the 3 conductor power cable to a grounded 3-terminal wall socket, HSA4012/14/51/52 is automatically grounded.

- **Confirm power source voltage**

The HSA4012/14/51/52 operates at a supply voltage described in "2.4 Power Supply and Grounding".

Before connecting this equipment, check that the proper voltage is being supplied to the wall power outlet.

- **Observe the fuse rating**

Danger of fire, etc. Use the rated fuse specified in "2.4 Power Supply and Grounding."

When replacing the fuse, be sure to pull out the power cord from the receptacle.

- **Whenever you feel any abnormality, stop operating the equipment**

In event smoke, peculiar odor or noise is emitted, immediately disconnect the power source and avoid further operation.

Whenever such an abnormality occurs, prevent the equipment from being used until it is completely repaired and immediately contact us or our sales agency.

- **Flammable gas**

Do not use this equipment in an inflammable gas. There is danger of fire and explosion.

- **Do not remove covers**

HSA4012/14/51/52 contains dangerously high voltages. Do not remove external covers.

No persons other than trained service technicians who are familiar with danger prevention should perform inspection of the interior of the HSA4012/14/51/52.

- **Do not modify**

Do not replace or modify the HSA4012/14/51/52 in a way other than that specified by NF CORPORATION under any circumstances.

There is risk of personnel hazard and damage to the equipment . The manufacturer reserves the option of refusing service in such cases.

- **Prevention of electric shock by output voltage of HSA4012/14/51/52**

The maximum outputs of HSA4012/14/51/52 are as follows:

HSA4012	50 Vrms (± 75 V)/2 Arms	HSA4051	100 Vrms (± 150 V)/1 Arms
HSA4014	50 Vrms (± 75 V)/4 Arms	HSA4052	100 Vrms (± 150 V)/2 Arms

Take every necessary step to prevent electric shock.

Directly touching the output or changing the cord connection while the output is ON may cause electric shock.

- **Caution on use of high frequency signal**



Note that use of devices producing electromagnetic waves in a radio frequency band is restricted by laws and regulations in some countries.

- **Safety related symbols and indications**

Following are general definitions of the symbols and indications used in the text and on HSA4012/14/51/52.



Operation manual reference symbol

Advises of possible hazard to the user, as well as the need to consult this manual when using an operation or function



Warning symbol

Appears in the text and on the product to advise risk of fatal or otherwise serious physical injury.



Cautionary symbol

Appears in the text and on the product to advise risk of damage to the product.



Symbol indicating danger of electric shock

This symbol is displayed in locations in danger of electric shock under specific conditions.

Contents

Foreword

Safety Precautions

1. Overview	1-1
1.1 Overview	1-1
1.2 Features	1-2
1.3 Applications	1-4
1.4 Function List	1-5
1.5 Principle of Operation	1-6
2. Preparation	2-1
2.1 Appearance and Accessory Check	2-1
2.2 Configuration	2-1
2.3 Assembly and Installation	2-2
2.4 Power Supply and Grounding	2-3
2.5 Simple Operation Check	2-5
2.6 Calibration	2-7
3. Description of Panel and Basic Operations	3-1
3.1 Names and Operations of Panel Components	3-1
3.2 Display on Power Up and Initial Setting	3-4
3.3 Input/Output Terminals	3-4
3.4 Input/Output Connection	3-7
3.5 Basic Operation Example	3-8
4. Applications	4-1
4.1 Maximum Output Current and Operation Area	4-1
4.2 Increase of Output by Balanced Output	4-2
5. Maintenance	5-1
5.1 Introduction	5-1
5.2 Daily Care	5-1
5.3 Storage, Repacking and Transport	5-1
5.4 Performance Test	5-2
5.4.1 Measuring Maximum Output Power	5-3
5.4.2 Measuring Maximum Output Current	5-4
5.4.3 Measuring Frequency Characteristic	5-5
5.4.4 Measuring Gain Error	5-6
5.4.5 Measuring Sine Wave Distortion Rate	5-6
5.4.6 Measuring Bias Addition Voltage	5-7
5.5 Handling Apparent Faults	5-13

6. Specifications 6-1

6.1 Input 6-1

6.2 Output 6-2

6.3 Input/Output Characteristic 6-5

6.4 General Specifications 6-6

6.5 Option 6-7

Figure

Figure 1-1	HSA4012/14 Block Diagram	1-6
Figure 1-2	HSA4051/52 Block Diagram	1-7
Figure 2-1	Replacement of Fuse	2-4
Figure 2-2	Connection of Power Supply Connector	2-4
Figure 2-3	Standard Connection Diagram	2-7
Figure 3-1	HSA4012 Front and Rear Panels	3-11
Figure 3-2	HSA4014 Front and Rear Panels	3-12
Figure 3-3	HSA4051 Front and Rear Panels	3-13
Figure 3-4	HSA4052 Front and Rear Panels	3-14
Figure 3-5	Preamp Output	3-6
Figure 3-6	Main Output & Monitor Output	3-6
Figure 3-7	Basic Connection Diagram	3-7
Figure 4-1	HSA4012 Operation Area	4-3
Figure 4-2	HSA4014 Operation Area	4-3
Figure 4-3	HSA4051 Operation Area	4-4
Figure 4-4	HSA4052 Operation Area	4-4
Figure 4-5	Current Waveform Asymmetric between Positive and Negative Polarities	4-1
Figure 4-6	Connection of Balanced Output	4-2
Figure 5-1	Measuring Maximum Output Power	5-3
Figure 5-2	Measuring Maximum Output Current	5-4
Figure 5-3	Measuring Frequency Characteristic	5-5
Figure 5-4	Measuring Sine Wave Distortion Rate	5-7
Figure 5-5	Measuring Bias Addition Voltage	5-8
Figure 6-1	HSA4012 External Dimensions	6-8
Figure 6-2	HSA4014 External Dimensions	6-9
Figure 6-3	HSA4051 External Dimensions	6-10
Figure 6-4	HSA4052 External Dimensions	6-11

Table

Table 2-1	Configuration Table	2-1
Table 5-1	HSA4012 Judgment	5-9
Table 5-2	HSA4014 Judgment	5-10
Table 5-3	HSA4051 Judgment	5-11
Table 5-4	HSA4052 Judgment	5-12
Table 5-5	Apparent Faults	5-13

1. Overview

1.1 Overview

The "HSA4012/14 1 MHz bipolar power supply" is a high-speed, wideband power amplifier with a frequency ranging from DC to 1 MHz and maximum output of 100/200 VA.

The "HSA4051/52 500 kHz bipolar power supply" is a high-speed, wideband power amplifier with a frequency ranging from DC to 500 kHz and maximum output of 100/200 VA.

The frequency characteristic is almost flat in the range of DC to 1 MHz (500 kHz) with little overshoot or sag of step response waveforms. Its ability to amplify from a direct current allows not only waveforms asymmetric between positive and negative polarities but also waveforms with a direct current superimposed to be transmitted correctly.

Implementing balanced output using two HSA4012/14/51/52s makes it possible to configure a high-speed, wideband power amplifier with double maximum output power.

The "HSA4000" series high-speed power amplifier/bipolar power supplies are available in the following models:

HSA4101	DC to 10 MHz	50 Vrms	1 Arms	50 VA
HSA4011	DC to 1 MHz	50 Vrms	1 Arms	50 VA
HSA4012	DC to 1 MHz	50 Vrms	2 Arms	100 VA
HSA4014	DC to 1 MHz	50 Vrms	4 Arms	200 VA
HSA4051	DC to 500 kHz	100 Vrms	1 Arms	100 VA
HSA4052	DC to 500 kHz	100 Vrms	2 Arms	200 VA

1.2 Features

1.2 Features

Wideband from DC to 1 MHz (HSA4012/14)

Its ability to amplify from a direct current allows not only waveforms asymmetric between positive and negative polarities but also waveforms with a direct current superimposed to be transmitted correctly.

High output, high-speed

HSA4012/14	150 Vp-p DC to 100 kHz
	140 Vp-p 100 kHz to 500 kHz
	110 Vp-p 500 kHz to 1 MHz
HSA4051/52	300 Vp-p DC to 50 kHz
	280 Vp-p 50 kHz to 200 kHz
	110 Vp-p 500 kHz to 500 kHz

Through rate

HSA4012/14	400 V/ μ s typ
HSA4051/52	450 V/ μ s typ

Optimal waveform response

Overshoot, sag 5% or less

Variable gain

HSA4012/14	$\times 10, \times 20, \times 50, \times 100$ or continuously variable from $\times 10$ to $\times 300$
HSA4051/52	$\times 20, \times 40, \times 100, \times 200$ or continuously variable from $\times 20$ to $\times 600$

Input: 2-line input allows 2-line additions

Two inputs A and B, switching between input impedance of 50Ω and 600Ω
Allows addition of inputs A and B

Low output impedance

HSA4012	0.25Ω $+0.8\mu\text{H}$ typ
HSA4014	0.125Ω $+0.4\mu\text{H}$ typ
HSA4051	1.0Ω $+3.2\mu\text{H}$ typ
HSA4052	0.5Ω $+1.6\mu\text{H}$ typ

DC addition capability

HSA4012/14	± 100 V 10-rotation potentiometer setting
HSA4051/52	± 200 V 10-rotation potentiometer setting

High balanced output capability

Using two units, supplies double output voltage/power to balanced load.

Protection circuit with overload display

Input/output connector

BNC connector, installed on front and rear panels

1.3 Applications

Piezoelectric actuator impedance measurement

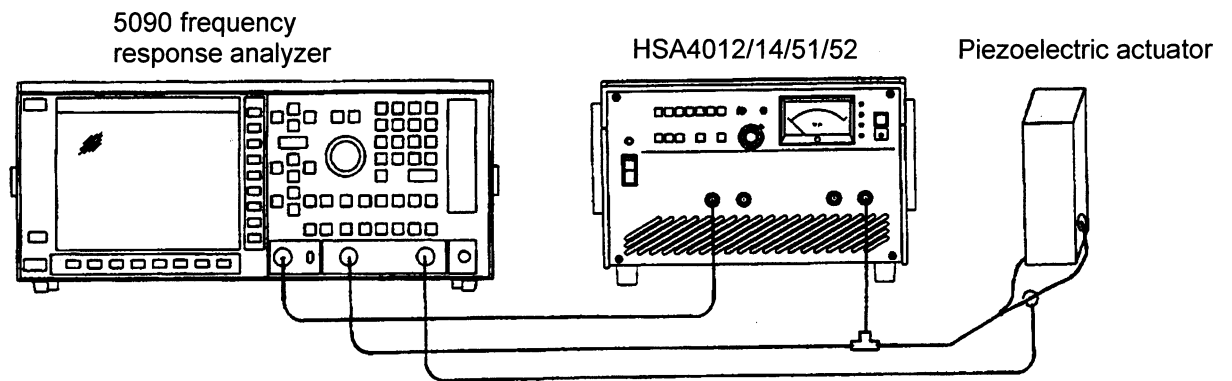

Ultrasonic motor drive

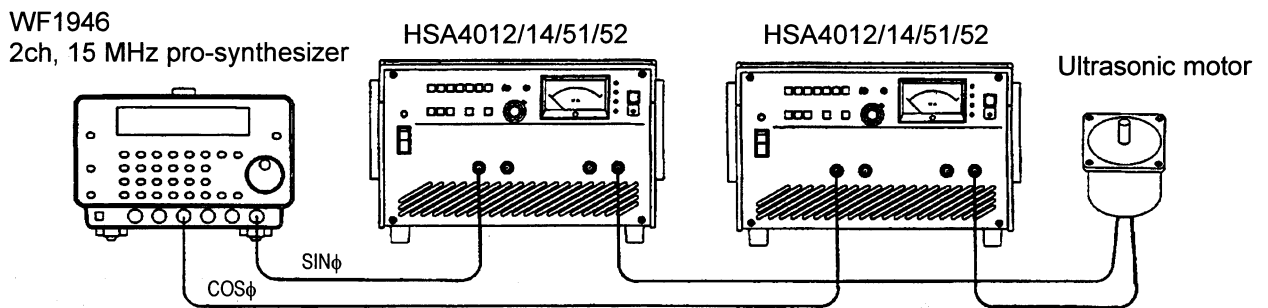

Amorphous magnetic substance test

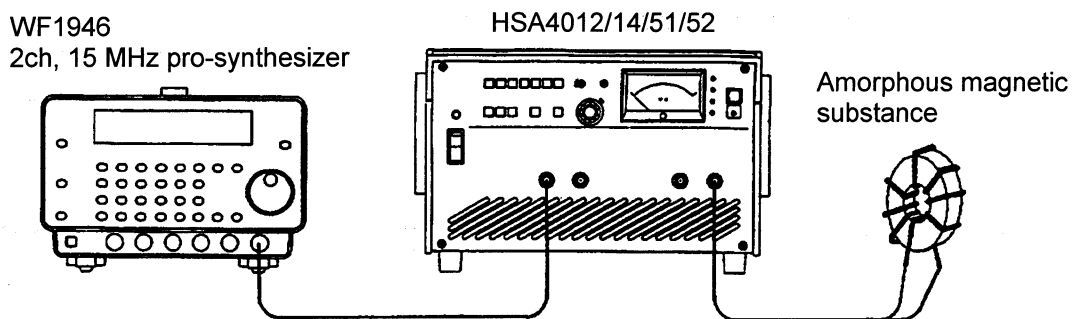

Capacitor ripple test

WF1946
2ch, 15 MHz pro-synthesizer

HSA4012/14/51/52

Capacitor

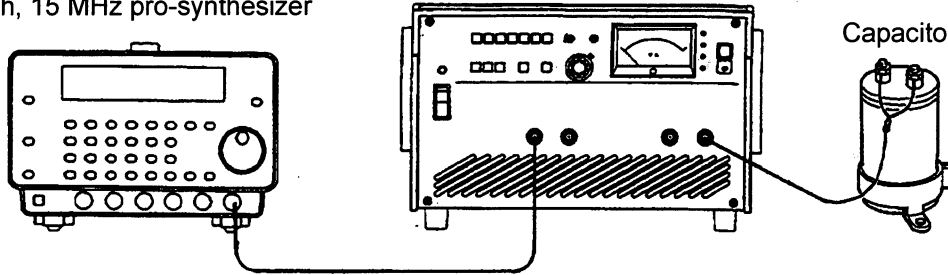

1.4 Function List

The HSA4012/14/51/52 has the following main functions:

		HSA4012/14	HSA4051/52
Output		ON/OFF switching	ON/OFF switching
Input	Input impedance switching	50Ω/600Ω	50Ω/600Ω
	Gain switching between input and output	Fixed ×10, ×20, ×50, ×100 or Continuously variable ×100 to ×300	Fixed ×20, ×40, ×100, ×200 or Continuously variable ×200 to ×600
	Bias addition	ON/OFF setting Continuously variable ±100 V, 10 rotations	ON/OFF setting Continuously variable ±200 V, 10 rotations
	Offset fine adjustment	Continuously variable ±0.5 V, 1 rotation	Continuously variable ±1 V, 1 rotation
Display	Output meter	Output current/voltage monitor FS: 150 Vrms, 2.5/5 Arms	Output current/voltage monitor FS: 300 Vrms, 1.2/2.5 Arms
		Overload lamp	Overload lamp

1.5 Principle of Operation

1.5 Principle of Operation

The HSA4012/14/51/52 consists of a preamp, power amp and power supply.

"Figure 1-1 HSA4012/14 Block Diagram" and "Figure 1-2 HSA4051/52 Block Diagram" show block diagrams of the HSA4012/14/51/52.

The preamp is a wideband operational amplifier. It has a two-input addition function, gain adjustment function, input impedance switching function and zero-point adjustment function.

The power amplifier is a wideband power amplifier using a high-speed FET for the output stage.

Voltage gain of HSA4012/14 is 15.6 times and has a bias superimposing function of ± 100 V and output voltage monitor function.

Voltage gain of HSA4051/52 is 33.2 times and has a bias superimposing function of ± 200 V and output voltage monitor function.

The output stage is protected from overload by a current restriction type protection circuit.

The output stage is forcibly air-cooled by a fan and if the internal temperature increases due to a drop of the rotation speed, stop or other abnormalities of the fan, the power switch is automatically turned off.

The power supply uses a low-noise type series regulator circuit.

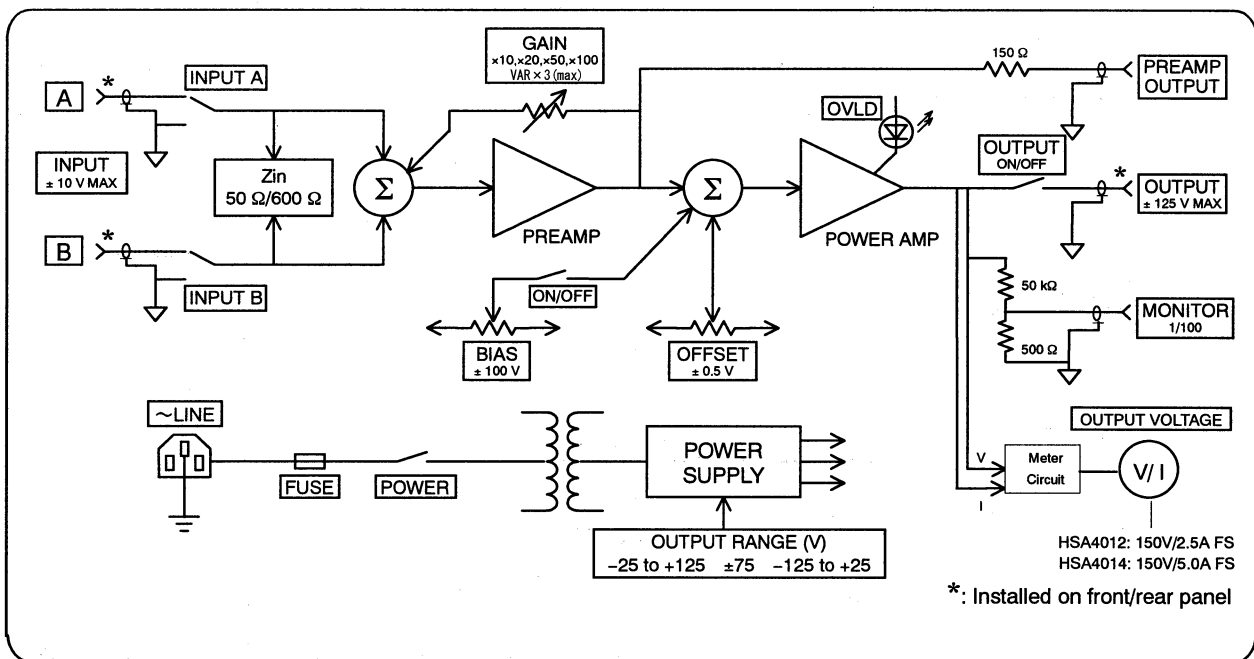

Figure 1-1 HSA4012/14 Block Diagram

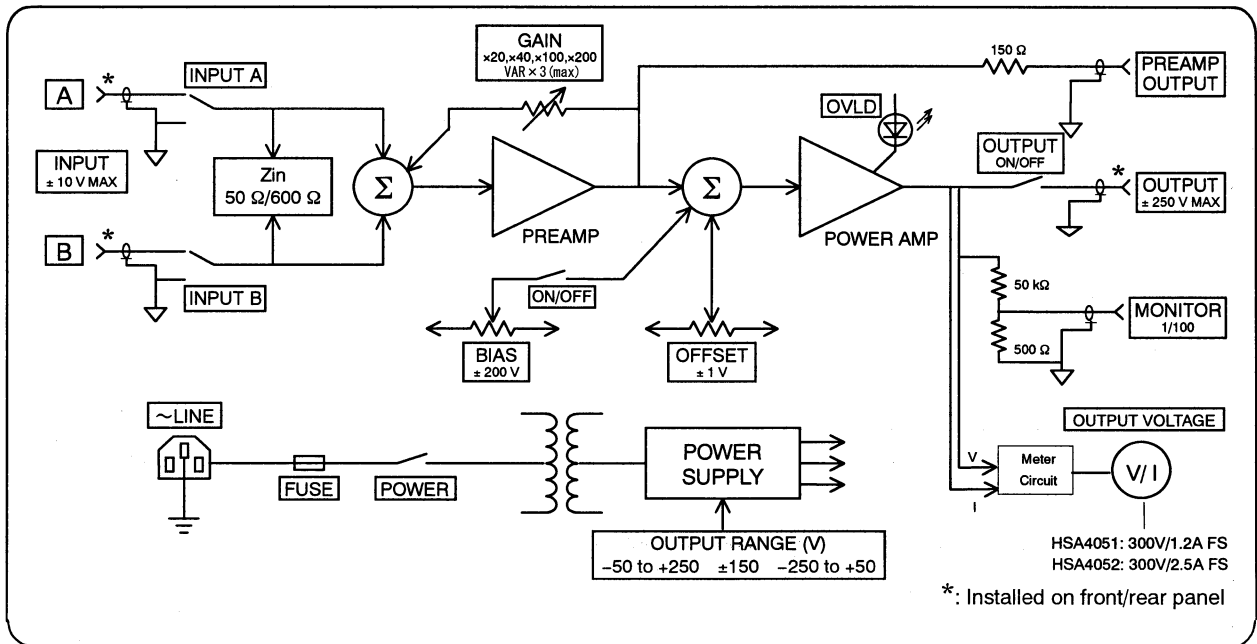

Figure 1-2 HSA4051/52 Block Diagram

2. Preparation

Before using the HSA4012/14/51/52, please read "Safety Precautions" again.

2.1 Appearance and Accessory Check

1. If there is any abnormality (damage or dent, etc.) in appearance of the cardboard box, immediately contact us or our sales agency.
2. Take the HSA4012/14/51/52 and accessories, etc. out of the cardboard box and check them. If any accessory is missing, contact us or our sales agency.
 - HSA4012/14/51/52 appearance check
Make sure there is no damage or dent on the panel surface, knobs and connectors, etc.
 - HSA4012/14/51/52 accessory check
Check that all accessories described in "Table 2-1 Configuration Table" are included.

2.2 Configuration

The HSA4012/14/51/52 has the following configuration. Check the number of pieces of each accessory.

Table 2-1 Configuration Table

HSA4012/14/51/52 main unit.....	1
Operation Manual	1
Accessories	
Power cord.....	1
Fuse ($\phi 5.2 \times 20$ mm) NOTE 1	2
(One is incorporated in inlet)	
Signal cord (BNC - BNC 1 m).....	2

NOTE 1: The ratings of the provided fuses ($\phi 5.2 \times 20$ mm) are as follows:

HSA4012	5 A/250 V	Time lag
HSA4014	10 A/250 V	
HSA4051	6.3 A/250 V	Time lag
HSA4052	10 A/250 V	

2.3 Assembly and Installation

Installation location

Do not place the HSA4012/14/51/52 on its rear or side on the floor or a desk.

Place the HSA4012/14/51/52 in such a way that the four rubber legs at the bottom are supported on a level surface such as a desk.

Rack mount

The HSA4012/14/51/52 can be mounted on a standard millimeter or inch rack using auxiliary brackets. Contact our sales representative specifying either millimeter or inch.

 **CAUTION**

For rack mount

- Use a rack mount with an effective mounting depth of 70 cm or more.
- Be sure to use a rail or shelf to support the HSA4012/14/51/52 so that it can resist shock and vibration.
- Provide upper and lower spaces of 5 cm or more to prevent an air flow from being blocked for the purpose of cooling inside the HSA4012/14/51/52. Furthermore, keep a space behind the rack, 30 cm or more apart from the wall to avoid convection of the exhaust air from the rear panel in the rack.

Installation condition

- The HSA4012/14/51/52 performs forced air cooling using a fan. Keep the front, rear and side where the air inlet and outlet are located away from the wall at least 30 cm to secure air circulation.

The allowable ranges of temperature and humidity are as follows:

During operation 0 to +40°C 10 to 90% RH

During storage -20 to +50°C 10 to 80% RH

However, keep the HSA4012/14/51/52 in an environment without condensation.

- Do not install HSA4012/14/51/52 in the following places:
 - Place exposed to inflammable gas
Danger of explosion. Do not install or use the HSA4012/14/51/52 in such a place under any circumstances.
 - Outdoors or place exposed to direct sun light or near fire or heat source
Can cause the HSA4012/14/51/52 to fail to satisfy performance or malfunction.
 - Place exposed to corrosive gas, water, dust, dirt or humid place
Can cause the HSA4012/14/51/52 to corrode or malfunction.
 - Place near electromagnetic field source or high-voltage equipment or power line
Can cause misoperation.
 - Place subject to vibration
Can cause misoperation or malfunction.

2.4 Power Supply and Grounding

The HSA4012/14/51/52 has the following power supply conditions:

Supply voltage:	90 to 110 VAC single-phase
Frequency range:	48 to 62 Hz
Power consumption:	HSA4012 450 VA or less
	HSA4014 900 VA or less
	HSA4051 500 VA or less
	HSA4052 950 VA or less

The supply voltage can be changed to 120 V, 200 V and 240 V as an option at the time of shipping from the factory.

The power supply input range for option 120 V, 200 V and 240 V is as follows:

120V	108 to 132V	Single-phase
200V	180 to 220V	Single-phase
240V	216 to 250V	Single-phase

Connect the power cable according to the following procedure:

1. Turn off the power switch of the HSA4012/14/51/52.
2. Insert the provided power cord into the inlet on the rear of the HSA4012/14/51/52.
3. Insert the power cord plug into the 3-pole power receptacle.

Observe the power fuse rating



WARNING

Danger of fire. When replacing the fuse, use one with the same rating.

The HSA4012/14/51/52 fuses are as follows:

	For power input voltage of 100V/120V	For power input voltage of 200V/240V
HSA4012	5 A/250 V time lag type $\phi 5.2 \times 20$ mm	3.15 A/ 250 V time lag type $\phi 5.2 \times 20$ mm
HSA4014	10 A/250 V $\phi 5.2 \times 20$ mm	6.3 A/ 250 V time lag type $\phi 5.2 \times 20$ mm
HSA4051	6.3 A/250 V time lag type $\phi 5.2 \times 20$ mm	5 A/ 250 V time lag type $\phi 5.2 \times 20$ mm
HSA4052	10 A/250 V $\phi 5.2 \times 20$ mm	6.3 A/ 250 V time lag type $\phi 5.2 \times 20$ mm

When replacing the fuse, be sure to pull out the power cord from the receptacle.

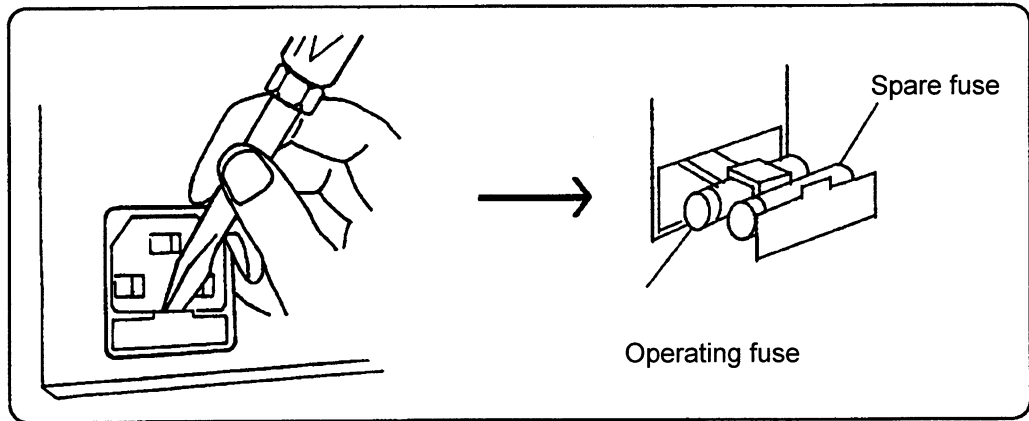

Figure 2-1 Replacement of Fuse

Be sure to ground

⚠ CAUTION

The HSA4012/14/51/52 is isolated from the primary side of the power source in the internal power transformer. However, make sure to ground the HSA4012/14/51/52 for safety.

Be sure to properly connect the ground. By connecting the 3 conductor power cable to a grounded 3-terminal wall socket, HSA4012/14/51/52 is automatically grounded.

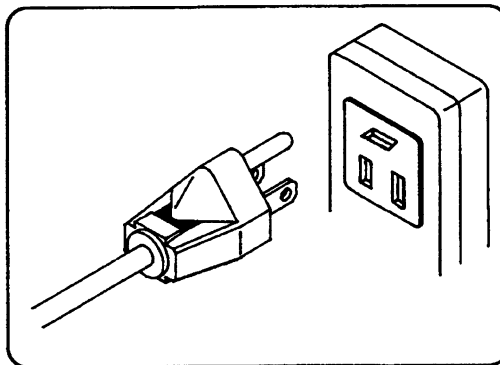

Figure 2-2 Connection of Power Supply Connector

2.5 Simple Operation Check

This section describes a simple receiving check when you purchase the product and an operation check after storage for an extended period of time.

WARNING

Do not remove the outer cover of the HSA4012/14/51/52.

No persons other than trained service technicians who are familiar with danger should check the interior of the product.

Connection

According to "Figure 2-3 Standard Connection Diagram", connect a signal generator, voltmeter and oscilloscope.

Panel setting

Set the panel knob and push button as follows:

Input setting: A, 600 Ω ; gain setting: $\times 100$ CAL; bias: OFF; dial 5.00; voltage range: ± 75 V (HSA4012/14)/ ± 150 V (HSA4051/52)

Operation

1. Turn on the power. After the overload lamp turns on transiently, the power lamp turns on, the output ON lamp turns off and the overload lamp turns off. Check that the level meter points to 0 V.
2. Check that when the frequency of the signal generator is set to 1 kHz, sine wave and the level is gradually increased from 0 V to 0.5 Vrms at input A, the reading of the output meter changes from 0 V to 50 Vrms.
3. Press the output ON switch and check with the oscilloscope and voltmeter that approximately 50 Vrms is output from the output connector. At this time, check that no distortion such as clip is generated on a waveform.
4. Change the gain range and check the output level.

HSA4012/14	When the gain is set to $\times 50$, $\times 20$, $\times 10$, the output becomes 25 V, 10 V and 5 V, respectively.
HSA4051/52	When the gain is set to $\times 200$, $\times 40$, $\times 20$, the output becomes 100 V, 20 V and 10 V, respectively.

2.5 Simple Operation Check

5. Set the level of the signal generator to 0 V, turn on the bias and adjust the bias dial, then check the reading of the output meter and output voltage.

HSA4012/14	Scale	2.00	3.00	5.00	7.00	8.00
	Output	-60 V	-40 V	0 V	+40 V	+60 V
	Reading of meter	-60 V	-40 V	0 V	+40 V	+60 V
HSA4051/52	Scale	2.00	3.00	5.00	7.00	8.00
	Output	-120 V	-80 V	0 V	+80 V	+120 V
	Reading of meter	-120 V	-80 V	0 V	+80 V	+120 V

6. Change the voltage range and check the output voltage range.

When the voltage range is changed, the output is turned OFF. It takes approximately 3 sec to change the voltage. After 3 sec, turn ON the output again.

 **CAUTION**

Repeatedly changing the voltage range in a short time may cause the power switch to turn OFF.

Turn ON the bias, adjust the bias dial and check the reading of the output meter and output voltage.

	Range	Dial setting
HSA4012/14	-25 to +125 V	With 3.75 to 10.00, -25 to +100 V is available
	-125 to +25 V	With 0.00 to 6.25, -100 to +25 V is available
HSA4051/52	-50 to +250 V	With 3.75 to 10.00, -50 to +200 V is available
	-250 to +50 V	With 0.00 to 6.25, -200 to +50 V is available

When the operation check is completed, turn OFF the bias for safety and return the bias dial to 5.00.

Necessary measurement instruments

The following measurement instruments are necessary for an operation check:

Signal generator: Frequency/1 kHz; waveform/sine wave; output voltage/0.5 V or more; manufactured by NF CORPORATION, WF1946, 2ch 15 MHz synthesizer, etc.

Oscilloscope: Frequency band/20 MHz or more, 100 V or more using a 10:1 probe

Voltmeter: AC and DC voltage measurement/range of 100 V or more

Since a load test is not performed, no load (terminator) resistor is required.

! WARNING

When smoke is produced from the equipment or you feel abnormal smell or abnormal sound, immediately unplug the power cord from the receptacle and do not use the product until it is completely repaired.

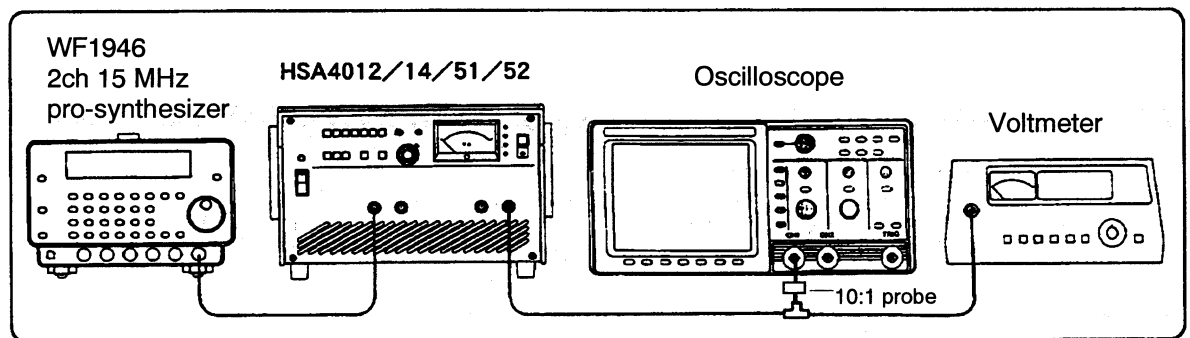

Figure 2-3 Standard Connection Diagram

2.6 Calibration

Perform "6.5 Performance Test" on the HSA4012/14/51/52 at least once a year. If the HSA4012/14/51/52 is used frequently and/or under an severe operating environment, it is necessary to perform the test more frequently.

Moreover, when conducting an important measurement or when the product is used for testing, it is recommended to carry out a performance test immediately before use. Performance tests should be conducted by persons who have general knowledge of measuring instruments.

3. Description of Panel and Basic Operations

3.1 Names and Operations of Panel Components

The HSA4012, HSA4014, HSA4051 and HSA4052 have the same panel configuration. See “Figure 3-1 HSA4012 Front and Rear Panels”, “Figure 3-2 HSA4014 Front and Rear Panels”, “Figure 3-3 HSA4051 Front and Rear Panels”, and “Figure 3-4 HSA4052 Front and Rear Panels”, respectively.

Front panel

① Power display lamp

This lamp turns ON when the HSA4012/14/51/52 is operating.

② Input signal changeover switch

Pressing both A and B adds up both signals.

③ Input impedance switching

Switches between $50\Omega/600\Omega$.

④ Gain switch/fine adjuster

Variable from $\times 10$ to $\times 300$ (HSA4012/14); $\times 20$ to $\times 600$ (HSA4051/52) by changing gain combinations

⑤ Offset fine adjuster

Can adjust a DC offset of output to 0 V.

⑥ Output meter status

Displays the levels of the output voltage and current.

Displays statuses such as +, -, V and A.

FS: 150 V 2.5 A/5 A (HSA4012/14)

FS: 300 V 1.2 A/2.5 A (HSA4051/52)

⑦ Output ON/OFF

Turns ON/OFF output.

A lamp turns ON when output is ON.

⑧ Overload lamp

This lamp turns ON when the HSA4012/14/51/52 is overloaded and output current is restricted.

3.1 Names and Operations of Panel Components

⑨ **Power switch**

Turns ON power. When the internal temperature increases, power is automatically turned "OFF."

⑩ **Selection of voltage range**

Sets an optimal voltage range for the desired waveform.

Three ranges of ± 75 V, -25 to $+125$ V, -125 to $+25$ V (HSA4012/14)

Three ranges of ± 150 V, -50 to $+250$ V, -250 to $+50$ V (HSA4051/52)

⑪ **Meter switching**

Switches between voltage and current.

⑫ **Input connectors A and B**

Signal input connectors

Connected in parallel with the input connector on the rear.

Use either one.

⑬ **BIAS switch dial**

When ON, bias voltages of DC voltage ± 100 V (HSA4012/14) or ± 200 V (HSA4051/52) can be added up.

⑭ **Monitor output**

Outputs a voltage of 1/100 of main output.

⑮ **Main output connector**

This is the main output of the HSA4012/14/51/52. Output of Max. 50 Vrms, ± 125 Vdc (HSA4012/14) and output of Max. 100 Vrms, ± 250 Vdc (HSA4051/52) It is connected in parallel with the main output connector on the rear. Use either one whenever possible.

Rear panel

⑰ **Input connectors A and B**

Signal input connectors

Connected in parallel with the input connector on the front.

⑱ **Main output connector**

This is the main output of the HSA4012/14/51/52. It is connected in parallel with the main output connector on the front.

⑳ **Preamplifier output**

Outputs a voltage of approximately 1/15 (HSA4012/14) or approximately 1/30 (HSA4051/52) of the main output.

㉑ **Power input fuse**

Has a dual function as an inlet and fuse holder.

Use a fuse of a specified value.

3.2 Display on Power Up and Initial Setting

3.2 Display on Power Up and Initial Setting

When power is turned on for the first time, perform the following initial setting:

Input selection: A; input impedance: 600Ω; gain: ×10 CAL (HSA4012/14), ×20 CAL (HSA4051/52); bias: OFF; dial: 5.00

Voltage range: ±75 V (HSA4012/14); ±150 V (HSA4051/52)

When power is turned on, the power lamp turns ON, the output ON lamp turns OFF, the overload lamp turns OFF and the level meter points to 0 V.

3.3 Input/Output Terminals

Input BNC connector A/B front/rear

This is a signal input connector. The connectors on the front and rear are connected in parallel. Use either one. Select input signal changeover switch A/B input. Pressing both A and B adds up both signals.

Input connector: BNC-R (1 for front and 1 for rear for both A and B)

Input impedance: Select 600Ω or 50Ω

Maximum allowable voltage: ±10 V



Adding a voltage exceeding the allowable input voltage may damage the equipment. Be careful not to exceed the allowable input voltage range.

Main output

This is an output connector. The connectors on the front and rear are connected in parallel. When using both connectors, be careful to ensure that the total output does not exceed maximum power. When using the product at a high frequency of 100 kHz or more, use only one of the connectors on the front and rear.

Output connector: BNC-R (1 for front and 1 for rear)

Maximum output voltage

HSA4012	HSA4014	HSA4051	HSA4052
±75 V range 50 Vrms or above, 40 Hz to 500 kHz 40 Vrms or above, 20 Hz to 1 MHz		±150 V range 100 Vrms or above, 40 Hz to 200 kHz 40 Vrms or above, 20 Hz to 500 kHz	
25Ω load	12.5Ω load	100Ω load	50Ω load
-25 to +125 V range -25 to +125 V (150 Vp-p) DC to 100 kHz -20 to +120 V (140 Vp-p) DC to 500 kHz -5 to +105 V (110 Vp-p) DC to 1 MHz		-50 to +250 V range -50 to +250 V (300 Vp-p) DC to 50 kHz -40 to +240 V (280 Vp-p) DC to 200 kHz +45 to +155 V (110 Vp-p) DC to 500 kHz	
125Ω load	62.5Ω load	500Ω load	250Ω load
-125 to +25 V range -125 to +25 V (150 Vp-p) DC to 100 kHz -120 to +20 V (140 Vp-p) DC to 500 kHz -105 to +5 V (110 Vp-p) DC to 1 MHz		-50 to +250 V range -250 to +50 V (300 Vp-p) DC to 50 kHz -240 to +40 V (280 Vp-p) DC to 200 kHz -155 to -45 V (110 Vp-p) DC to 500 kHz	
125Ω load	62.5Ω load	500Ω load	250Ω load

Maximum output current

HSA4012	HSA4014	HSA4051	HSA4052
2 Arms (5.66 Ap-p) 40 Hz to 500 kHz	4 Arms (11.3 Ap-p) 40 Hz to 500 kHz	1 Arms (2.83 Ap-p) 40 Hz to 200 kHz	2 Arms (5.66 Ap-p) 40 Hz to 200 kHz
±1.0 A DC to 40 Hz	±2.0 A DC to 40 Hz	±0.5 A DC to 40 Hz	±1.0 A DC to 40 Hz

Output impedance

HSA4012	HSA4014	HSA4051	HSA4052
0.25Ω +0.8μH or less	0.125Ω +0.4μH or less	1Ω +3.2μH or less	0.5Ω +1.6μH or less

3.3 Input/Output Terminals

⚠ WARNING

The maximum voltage of the HSA4012/14/51/52 is ± 125 V (HSA4012/14) or above and +250 V (HSA4051/52) or above. Touching the HOT side of the output may cause electric shock. Observe the following precautions for safe use:

- Turn OFF power when conducting wiring.
- When power is ON, do not touch the HOT side of the output. Do not touch it when your body is wet in particular.

Monitor output

The HSA4012/14/51/52 is provided with a monitor output connector to observe the output voltage and allows you to observe an output waveform by directly connecting an oscilloscope to it. Monitor output is also output when the output is OFF. A voltage equivalent to 1/100 of the main output is output.

Output connector: BNC-R (front)

Output voltage: 1/100 of main output (in-phase with respect to input)

Output impedance: $500\Omega \pm 10\%$

⚠ CAUTION

The monitor output is derived from the main output by dividing it through resistors. Thus, note that it may include a certain error caused by input impedance of devices connected.

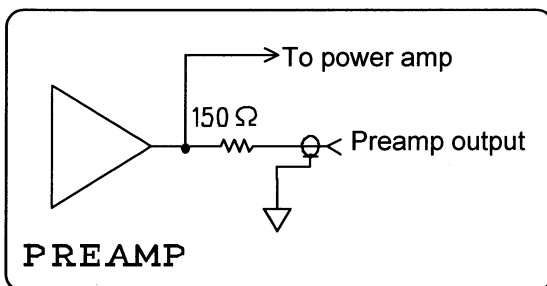

Figure 3-5 Preamp Output

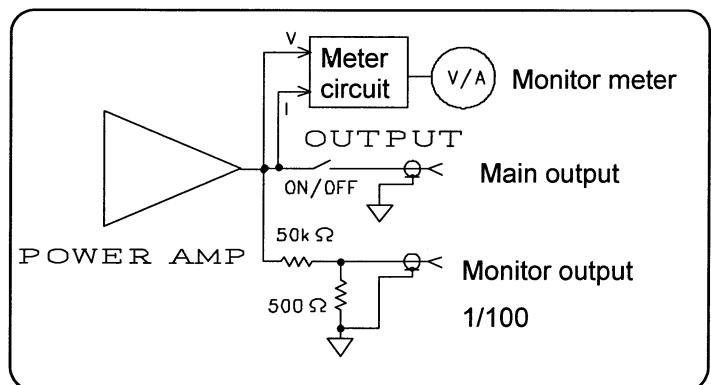

Figure 3-6 Main Output & Monitor Output

Preamp output

This is a preamp output. Used for connection of balanced output using two units of HSA4012/14/51/52. A voltage equivalent to approximately 1/15.6 (HSA4012/14), 1/31.2 (HSA4051/52) of the main output is output.

☞ For balanced output, see "4.2 Increase of Output Using Balanced Output."

Output connector: BNC-R (rear)

Output voltage: 1/15.6 of main output (HSA4012/14)
1/31.2 of main output (HSA4051/52)
Inverse phase with respect to input

Output impedance: $150\Omega \pm 5\%$

3.4 Input/Output Connection

A connection diagram is shown in "Figure 3-7 Basic Connection Diagram." To exploit full performance of the HSA4012/14/51/52, the following points should be noted on the signal generator, connection cord and load.

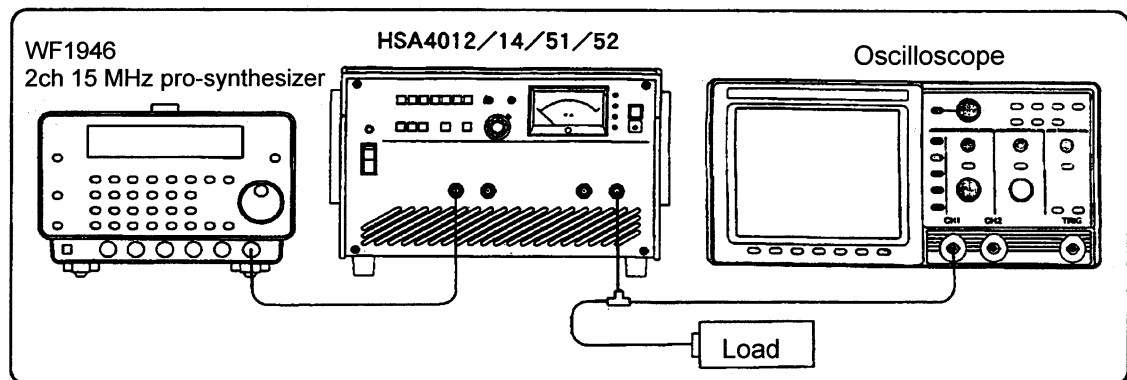

Figure 3-7 Basic Connection Diagram

Signal generator

Use a signal generator that generates waveforms with correct frequencies and large output capacity of 2 to 5 Vrms whenever possible.

When using a high frequency of 100 kHz or more, use a signal generator with output impedance of 50Ω and set the input impedance of the HSA4012/14/51/52 to 50Ω .

Signal cord

Use the provided BNC cable as the input cord.

For the output cord, also attach a BNC connector near the load and use the provided BNC cable.

Load

Attach a BNC connector near the load and use the provided BNC cable.

Place the load near the HSA4012/14/51/52 whenever possible and use it within the range of the length of the provided cable.

3.5 Basic Operation Example

Selection of input selection/input impedance

Connect either one of input connectors A and B with the output of the signal generator using the provided signal cord.

Push the input signal changeover switch A or B to which the input connector is connected to select input impedance 50Ω or 600Ω.

 **CAUTION**

1. Use input connectors A and B either on the front or rear. If the signal generators are connected to both sides, the signal generators themselves are connected, which may damage the signal generators.
2. Applying a voltage exceeding the allowable input voltage may damage the equipment. Be careful not to exceed the allowable input voltage range ± 10 V.

When a waveform that adds up two signals is necessary, connect the signal generators to both input connectors A and B and push in both input signal changeover switches A and B. To change the addition ratio, change the level using the signal generator connected.

Selection of voltage range

Set an optimal voltage range for the output waveform used (symmetric waveform whose positive and negative peak voltages are identical or waveform superimposed on a positive DC or waveform superimposed on a negative DC).

Adjustment of output voltage

For HSA4012/14:

The gain can be set within the range of $\times 10$ to $\times 300$ using gain switch of $\times 10$, $\times 20$, $\times 50$ and $\times 100$ and fine adjuster.

To obtain a maximum output voltage of 50 Vrms, the signal generator must have an output voltage of 0.167 V/50Ω to 600Ω (gain $\times 300$) to 5 V/50Ω to 600Ω (gain $\times 10$).

For HSA4051/52:

The gain can be set within the range of $\times 20$ to $\times 600$ using gain switch of $\times 20$, $\times 40$, $\times 100$ and $\times 200$ and fine adjuster.

To obtain a maximum output voltage of 100 Vrms, the signal generator must have an output voltage of 0.167 (gain $\times 600$) to 5 V (gain $\times 20$).

Use a signal generator providing a high output of 2 to 5 Vrms wherever possible.

Fine adjustment of output offset

In the case of a problem that occurs if a DC component is superimposed on a signal such as inductance, it is possible to perform fine adjustment that sets the offset voltage included in the output signal of the HSA4012/14/51/52 to zero. Perform fine adjustment of the offset voltage according to the following procedure.

A DC offset changes to a certain degree by the gain setting range. First, adjust the output gain. Then, remove the input cord. Select A or B as the input. Set input impedance to 50Ω. Connect the DC voltmeter (digital voltmeter, etc.) to the output and adjust the DC output voltage to zero using pre-set variable resistor for offset fine adjustment.

This offset fine adjustment is performed with the output ON/OFF switch set to ON.

The product can be used more stably if offset fine adjustment is performed 30 minutes to 1 hour after initial drifts are completed after power is turned on.

After fine adjustment of output offset is completed, connect the removed input cord between the input connector (A or B according to the selected signal) and the output of the signal generator.

Addition of DC bias

The HSA4012/14/51/52 can output the output voltage signal with a DC voltage added. Turn ON the bias switch and perform setting using the bias dial. The range of the bias voltage is ±100 V for HSA4012/14, and ±200 V for HSA4051/52. If the input is zero, the voltage added can be monitored by the output meter.

The relationship between the dial memory and output bias voltage can be calculated as follows:

For HSA4012/14:

$$\text{Bias output voltage} = (\text{set scale} - 5.00) \times 20 \text{ Vdc}$$

For HSA4051/52:

$$\text{Bias output voltage} = (\text{set scale} - 5.00) \times 40 \text{ Vdc}$$

 **CAUTION**

If the output voltage exceeds the set output voltage range, the output waveform is clipped and the overload lamp turns ON. When adding up the DC bias, take the set output voltage range into account and be careful not allow the waveform to be clipped.

Monitoring output voltage

The HSA4012/14/51/52 is provided with a monitor output and a monitor meter for monitoring the output voltage.

The monitor output connector allows an output waveform to be observed by directly connecting an oscilloscope and the output waveform is output irrespective of output ON/OFF. As the output voltage, a voltage equivalent to 1/100 of the main output is output.

The monitor output is derived from the main output by dividing it through resistors and output. Therefore, the monitor output decreases because it is influenced by input impedance (load resistance) of the device connected.

The influence of the load is calculated as follows:

$$\text{Monitor output} \times \left(1 - \frac{500\Omega}{500\Omega + \text{load resistance} (\Omega)}\right)$$

The output meter is of a double wave rectification average detection type and indicates values in sine wave root-mean-square values. In the case of DC, values are shown in absolute values, and so the same value is shown without polarity "+" or "-".

3.5 Basic Operation Example

Furthermore, if AC is superimposed on DC, an average value is shown. For example, if a 5 Vrms sine wave is superimposed on a +10 V DC, 10 V is indicated and a 5 Vrms sine wave with zero DC component is indicated as 5 V.

Output ON/OFF control

The main output signal can be turned ON/OFF. ON/OFF is changed through a relay contact.

 **CAUTION**

Note that if a load containing an inductance component is connected, turning OFF the output may generate a high voltage.

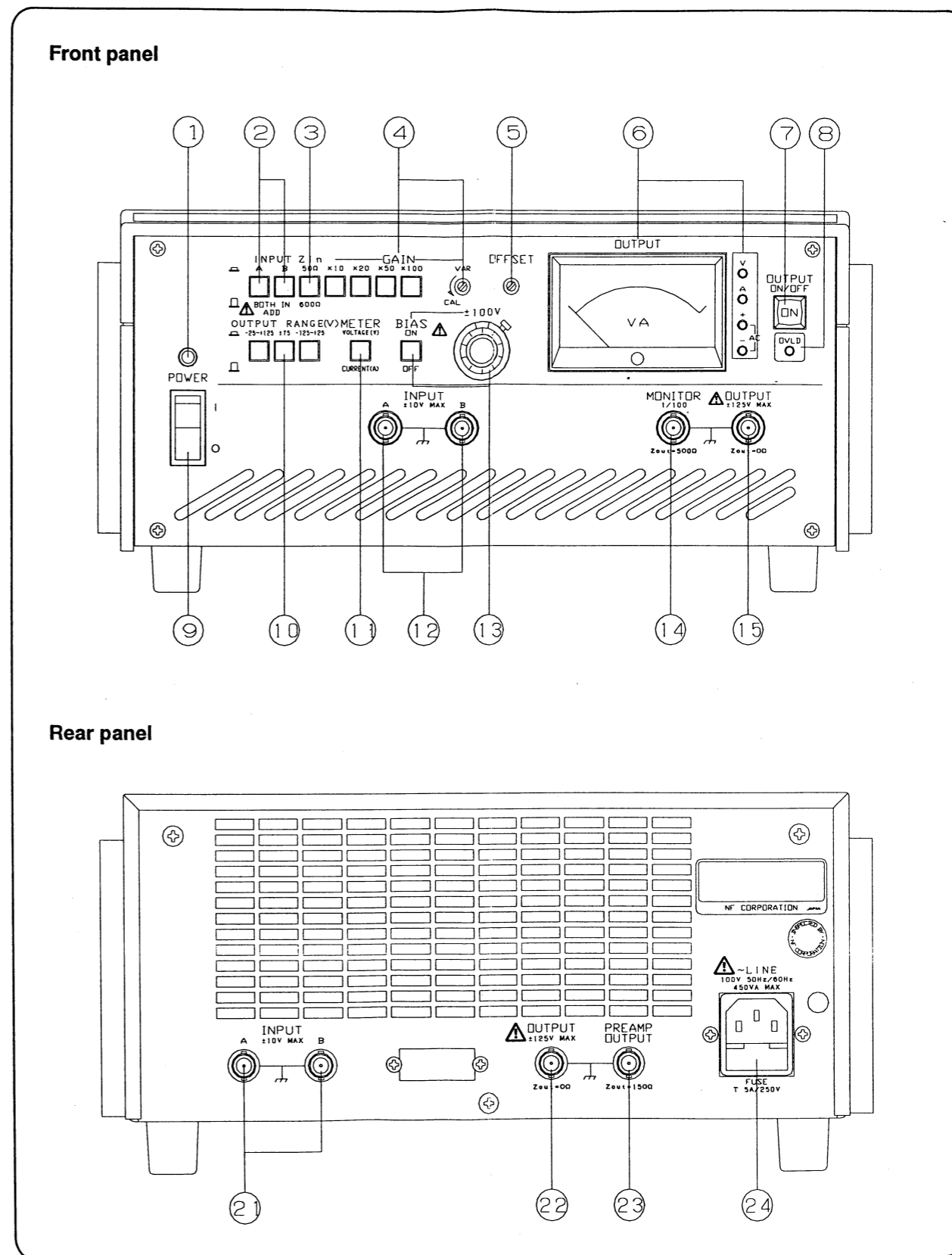

Figure 3-1 HSA4012 Front and Rear Panels

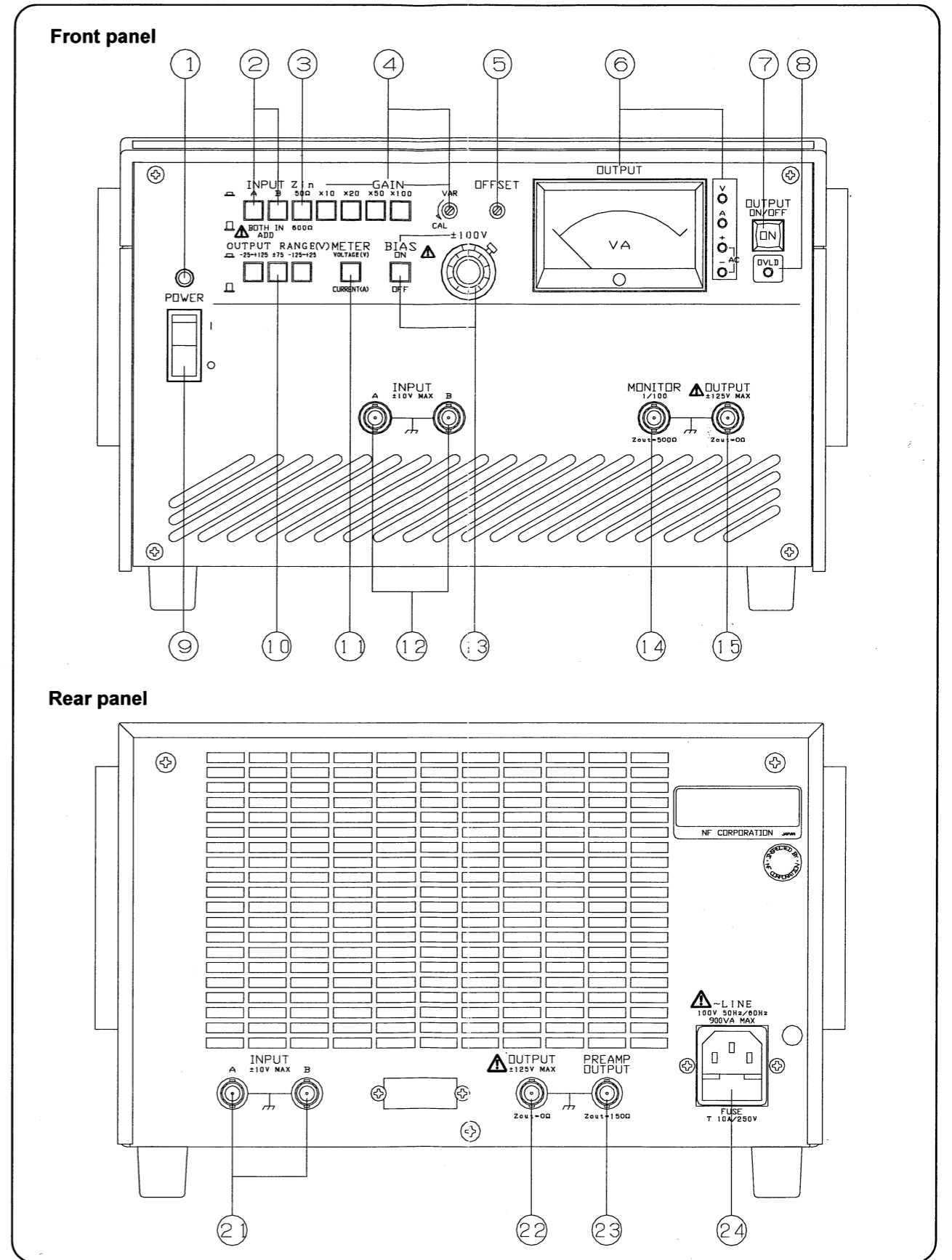

Figure 3-2 HSA4014 Front and Rear Panels

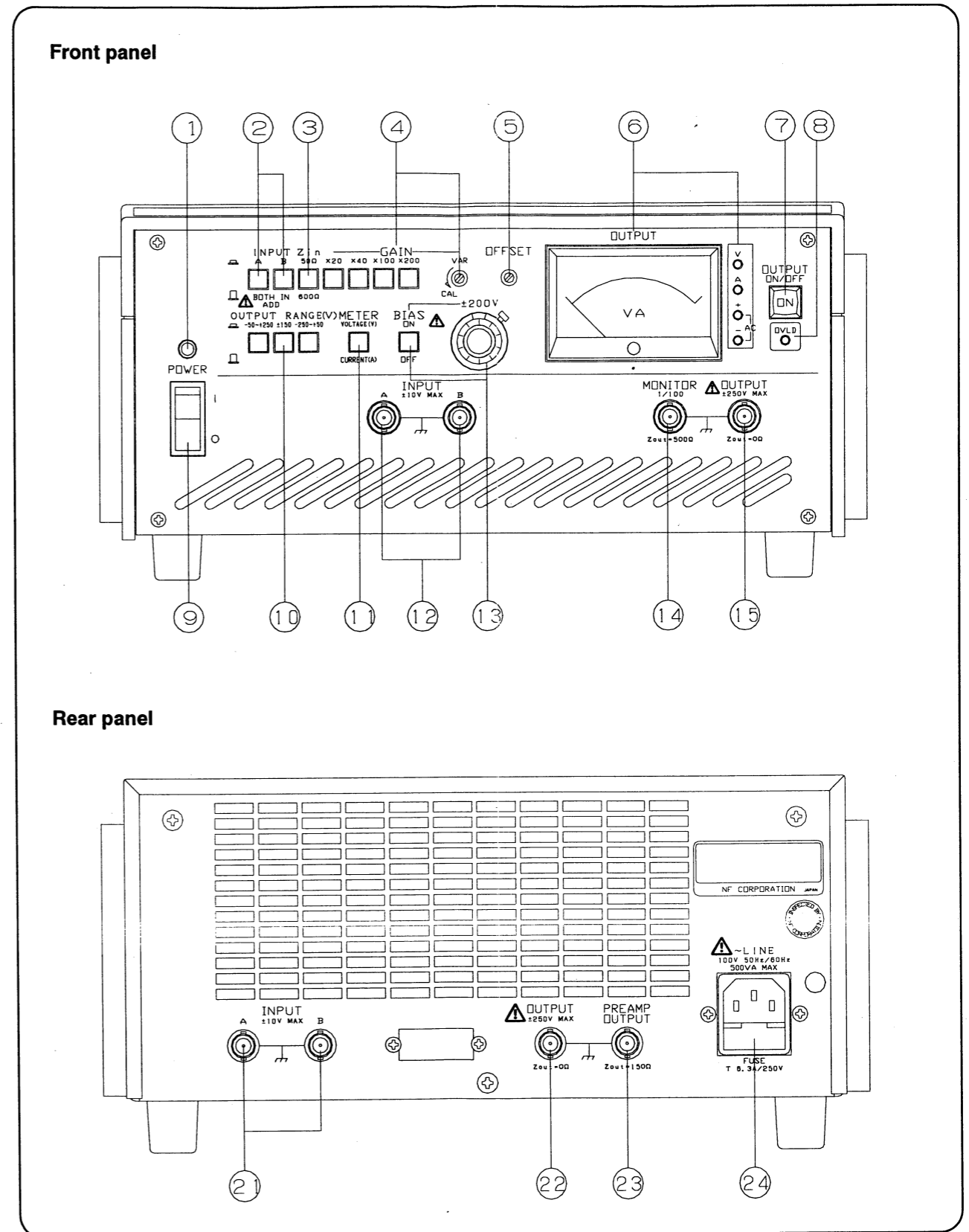

Figure 3-3 HSA4051 Front and Rear Panels

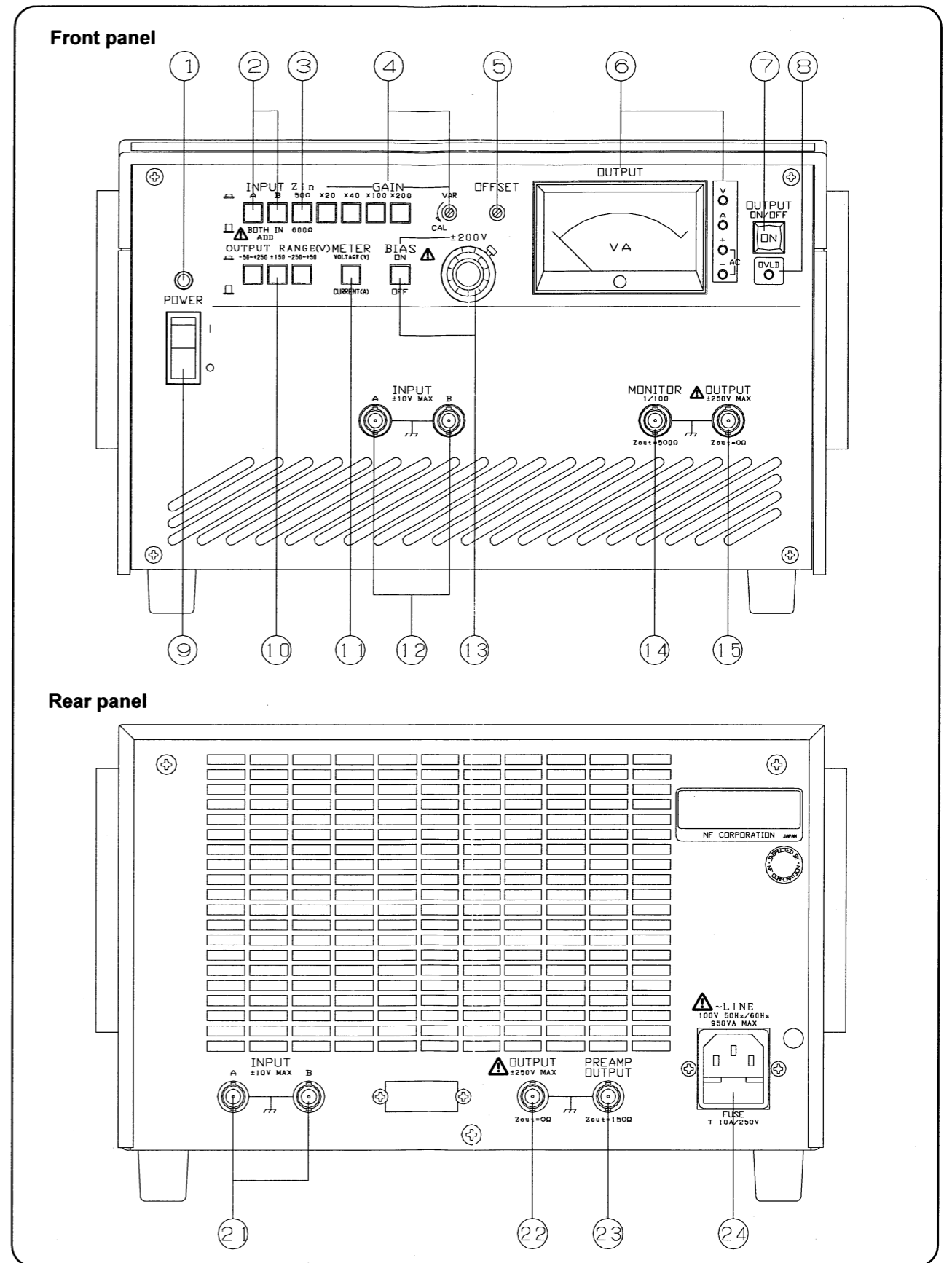

Figure 3-4 HSA4052 Front and Rear Panels

4. Applications

4.1 Maximum Output Current and Operation Area

The HSA4012/14/51/52 is provided with an output current restriction protection circuit that detects and restricts an output current and the maximum output current is determined by this protection circuit. This restriction value varies depending on the frequency and output voltage. This relation is shown in "Figure 4-1 HSA4012 Operation Area" to "Figure 4-4 HSA4052 Operation Area."

☞ For the operation area, see "Figure 4-1 HSA4012 Operation Area", "Figure 4-2 HSA4014 Operation Area", "Figure 4-3 HSA4051 Operation Area" and "Figure 4-4 HSA4052 Operation Area".

The graph shows an AC (frequency 40 Hz or more) peak value area and a DC (frequency 1 Hz or less) and AC average value areas. In the frequency range of 1 to 40 Hz, the current is protected with an intermediate value.

In general, if the load when an AC signal is used is resistance, the 1st quadrant and 3rd quadrant are the operation area and if the load is capacitive or inductive, all quadrants become the operation area.

Furthermore, if the load has an electromotive force even when a DC signal is used and power is poured from the load, the 2nd quadrant and 4th quadrant become the operation area. An electronic-load-like operation corresponds to this case.

The operation area when a signal waveform is asymmetric between positive and negative polarities and a direct current is generated will be explained. In the case of a waveform like "Figure 4-5 Signal Waveform Asymmetric between Positive and Negative Polarities", consider positive and negative polarities of the waveform separately as an average value (+I_{ave}), peak value (+I_p) on the positive side and an average value (-I_{ave}) and peak value (-I_p) on the negative side.

The average values (+I_{ave}, -I_{ave}) and peak values (+I_p, -I_p) are each restricted by the DC operation restriction area and AC peak operation restriction area.

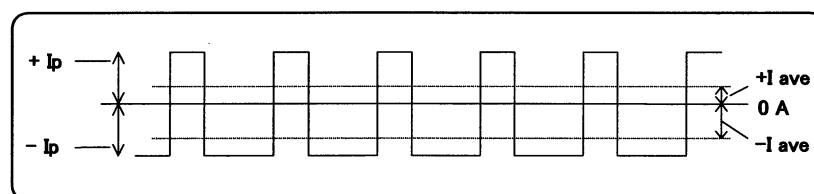

Figure 4-5 Current Waveform Asymmetric between Positive and Negative Polarities

4.2 Increase of Output by Balanced Output

When balanced output connection is implemented using two HSA4012/14/51/52s, it is possible to double the output voltage and output power (the output current remains the same as with one HSA4012/14/51/52). The connection is realized by connecting the preamp output of the master device to the input connector (A or B) of the slave device as shown in "Figure 4-6 Connection of Balanced Output" and setting input impedance to 600Ω. Set the gain of the slave device to ×10 (for HSA4012/14 and ×20 for HSA4051/52), adjust the pre-set variable resistor so that the master device and slave device have the same output voltage (the phase is reversed).

The overall gain is determined by the gain setting of the master device.

Connect the load between the master device and slave device as shown in "Figure 4-6 Connection of Balanced Output." At this time, it is not possible to connect one of the load terminals commonly to the chassis of the HSA4012/14/51/52 and signal generator. Therefore, when used for this connection, the load must be insulated from the grounding potential and signal source.

The master device and slave device make the most of their performance when they are the same model. If they are different models, use the output current within the range of the one with a smaller output current and the output voltage within the range of the sum of both output voltages. The frequency characteristic depends on the model with a narrower band.

CAUTION

Insulate the load from the grounding potential and signal source.

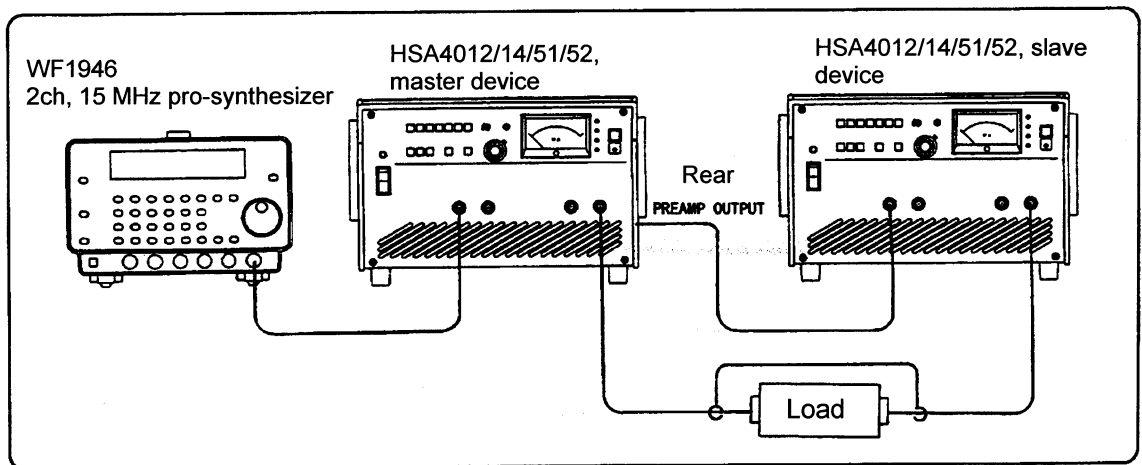

Figure 4-6 Connection of Balanced Output

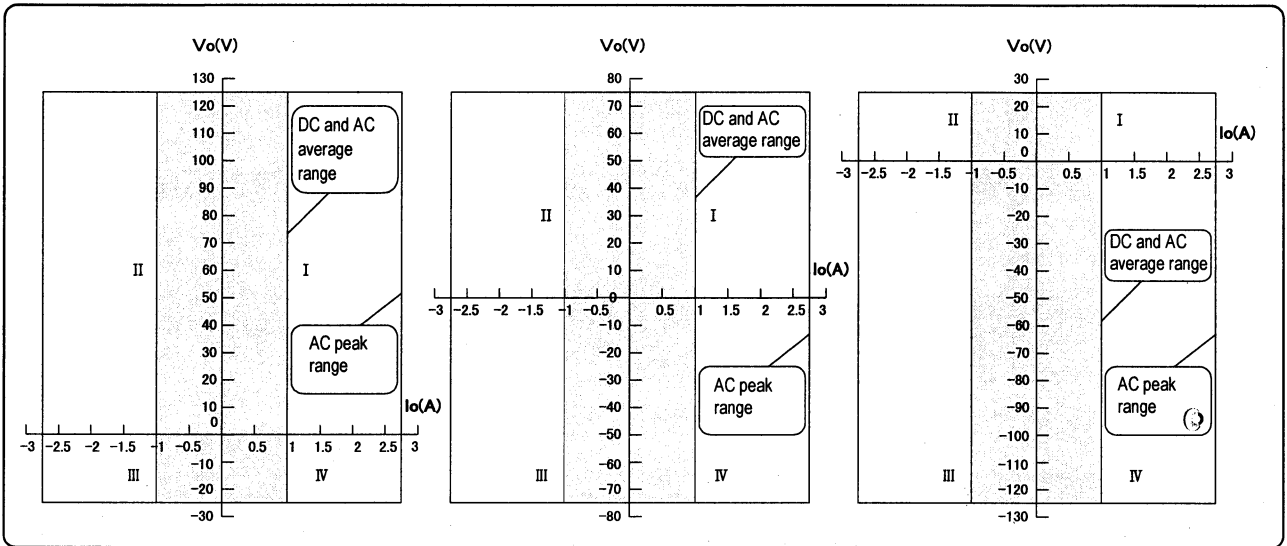

Figure 4-1 HSA4012 Operation Area

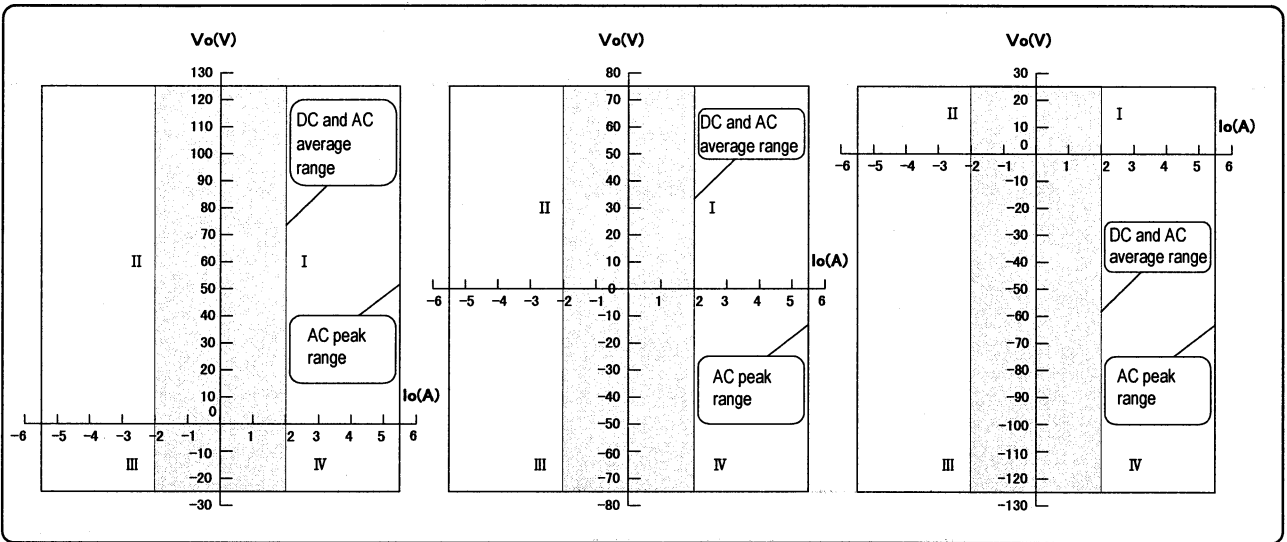

Figure 4-2 HSA4014 Operation Area

4.2 Increase of Output by Balanced Output

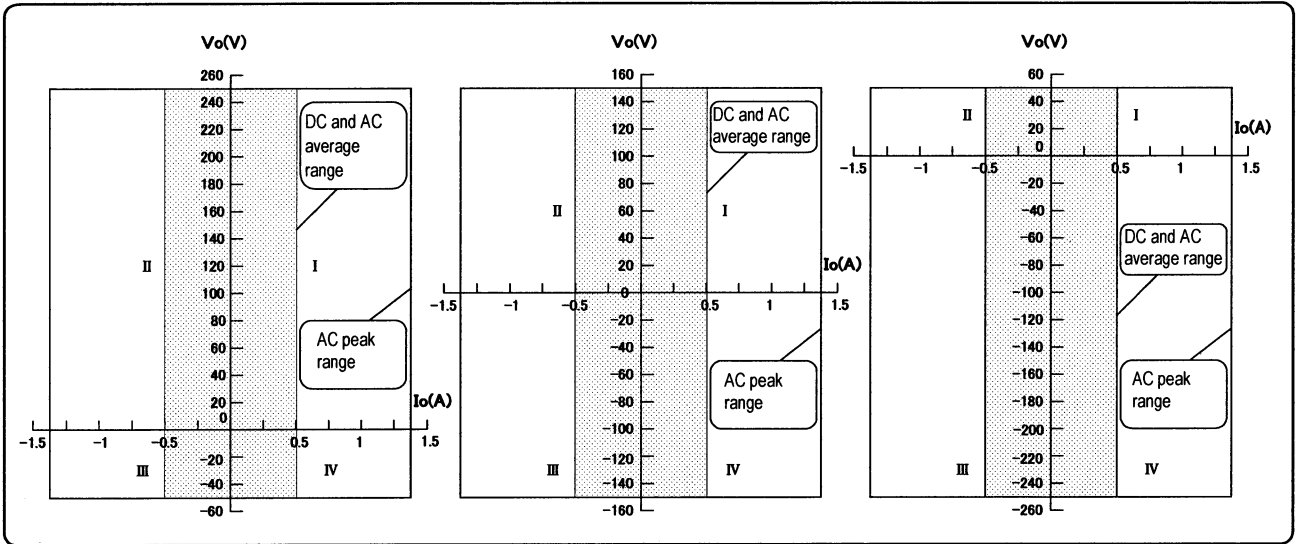

Figure 4-3 HSA4051 Operation Area

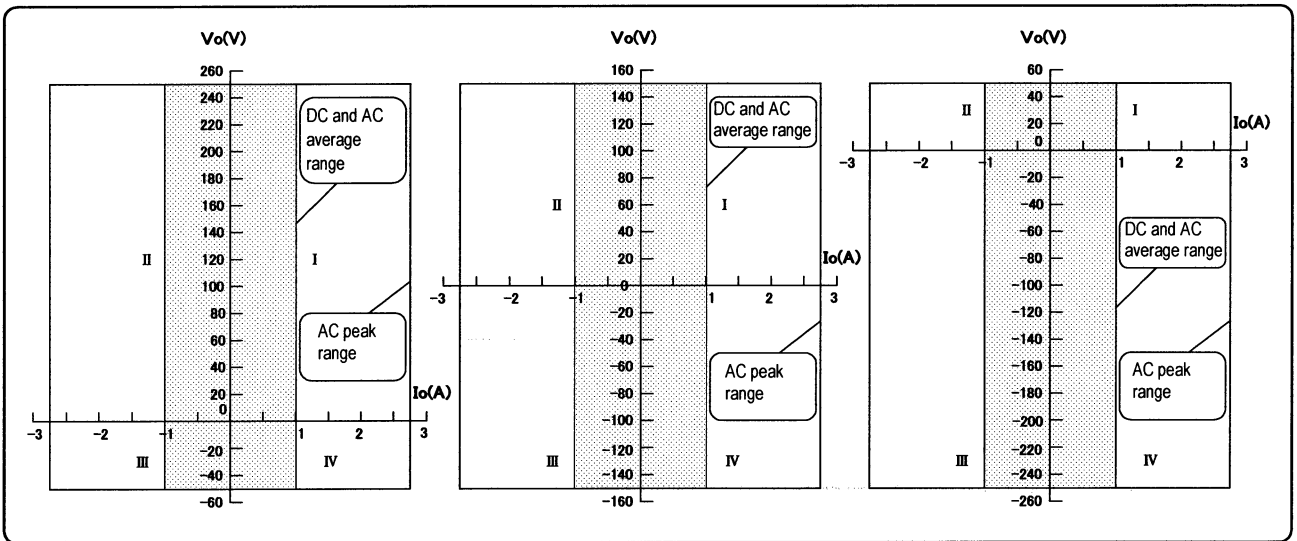

Figure 4-4 HSA4052 Operation Area

5. Maintenance

5.1 Introduction

This section describes the following:

- Cautions and storage method when product is not used for extended period of time
- Cautions for repacking and transportation
- Performance tests necessary for receiving inspection for preventive maintenance and performance check after repair
- Symptoms and action for apparent fault

☞ For a simple operation check, see "2.5 Simple Operation Check."

When the product does not pass an operation check or performance test or malfunctions, ask us or our sales agency for calibration or repair.

5.2 Daily Care

When panel or case is dirty

When the panel or case is dirty, wipe it using a soft cloth. If the panel or case is extremely dirty, wipe it with a cloth soaked in a detergent. Using an organic solvent such as thinner and benzene or chemical cloth may alter the quality or damage the paint rendering characters illegible.

5.3 Storage, Repacking and Transport

Storage in case of non-use for extended period of time

- Remove the power cord from the receptacle and HSA4012/14/51/52.
- Store the product in a shelf or rack, etc. places where there is no falling object or dust. If the product is possibly subject to dust, put a cloth or polyethylene cover.
- The environmental condition for storage is -20°C to 50°C , 10% to 80% RH, but avoid places with drastic temperature variations or exposed to direct sunlight and store in an environment at ordinary temperatures.

Repacking and transport

When repacking the product for transport or asking for repair, consider the weight of the HSA4012/14/51/52 and note the following points.

- Put the HSA4012/14/51/52 in a polyethylene bag or wrap it with a sheet.
- Prepare a cardboard box which will withstand the weight of the HSA4012/14/51/52 and provide a sufficient space.
- Put a cushioning material to protect the six sides of the HSA4012/14/51/52 and pack it. Ideally, use the cardboard box and stuffing materials provided at the delivery.
- When asking for transport, inform the transport company that this product is a precision instrument.

5.4 Performance Test

5.4 Performance Test

- A performance test is conducted to prevent deterioration of the performance of the HSA4012/14/51/52 or as part of preventive maintenance. It is also conducted when a receiving inspection, periodic inspection or a performance check after repair is required. If the performance test result shows that the product does not meet the specification, calibration or repair is required.

⚠ WARNING

Do not remove the outer cover of the HSA4012/14/51/52.

Inspections of the interior of the product should not be performed by any persons other than trained service technicians who are familiar with danger.

- The measuring instruments used for performance tests are as follows:

Measuring instrument	Main performance	Recommended product
Signal generator	0.01 Hz to 10 MHz Sine wave, square wave, 20 Vp-p	WF1946 manufactured by NF CORPORATION
Low distortion signal generator	10 Hz to 1 MHz low distortion	E-1205 manufactured by NF CORPORATION
AC voltmeter	10 Hz to 10 MHz, 1mV to 300V	8920A manufactured by Fluke Corporation
Digital voltmeter	0 to ±300V	
Frequency response analyzer	10 Hz to 1 MHz	5090 manufactured by NF CORPORATION
Oscilloscope	DC to 50 MHz, 10mV to 300V	
Distortion meter	10 Hz to 600 kHz	DM-153B manufactured by NF CORPORATION
Terminator	Depends on the model. HSA4012: 25Ω ±1%/100 W and 5Ω ±5%/20 W HSA4014: 12.5Ω ±1%/200 W and 2.5Ω ±5%/40 W HSA4051: 100Ω ±1%/100 W and 10Ω ±5%/10 W HSA4052: 50Ω ±1%/200 W and 5Ω ±5%/20 W	

- Before starting performance tests, perform fine adjustment of the offset voltage of the HSA4012/14/51/52 to zero and check the following items:
 - ☞ **For the fine adjustment method, see "3.5 Basic Operation Example Output Offset Fine Adjustment."**
 - Is the supply voltage within the proper range?
 - Are the ambient temperature and ambient humidity within the range of 15°C to 35°C, 25% to 75% RH?
 - Is there condensation?
 - Have 30 minutes or more elapsed after power is turned on?
 - Test data evaluation is described at the end of this section to allow you to evaluate test data all together for each model.

5.4.1 Measuring Maximum Output Power

Connection

Connect the signal generator, AC voltmeter, oscilloscope and terminator resistance as shown in "Figure 5-1 Measuring Maximum Output Power."

Setting

Set the HSA4012/14/51/52 as follows:

Input changeover: "A"; input impedance: "600 Ω "; bias addition: "OFF/dial 5.00"

	HSA4012	HSA4014	HSA4051	HSA4052
Gain setting	$\times 20\text{CAL}$	$\times 20\text{CAL}$	$\times 40\text{CAL}$	$\times 40\text{CAL}$
Voltage range	$\pm 75\text{ V}$	$\pm 75\text{ V}$	$\pm 150\text{ V}$	$\pm 150\text{ V}$
Terminator resistance	25 Ω	12.5 Ω	100 Ω	50 Ω

Test procedure

Select a sine wave as the waveform of the signal generator, adjust the frequency to a check frequency and turn ON the output ON/OFF switch of the HSA4012/14/51/52. Gradually increase the output voltage of the signal generator from 0 V. Observe the waveform using an oscilloscope and record the output voltage when the waveform starts to clip (or distortion increases).

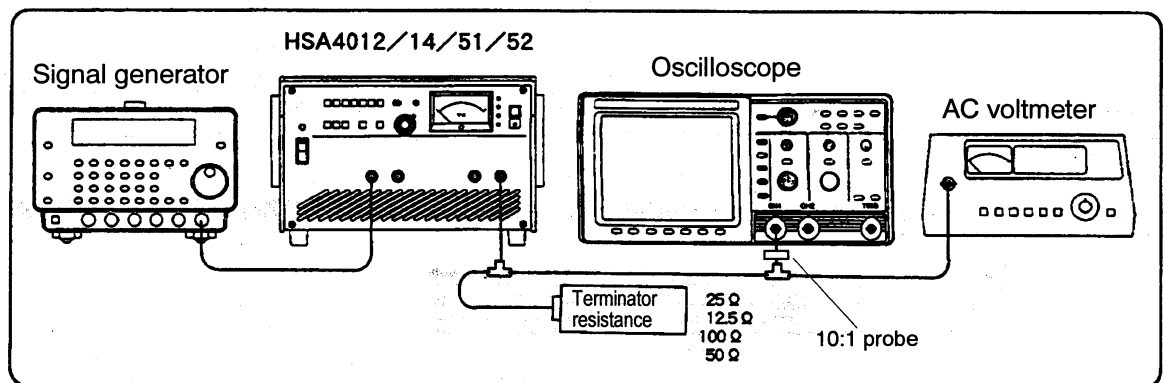

Figure 5-1 Measuring Maximum Output Power

Judgment criteria

The judgment criteria for each model is shown in the "Measurement of maximum output voltage" field in Tables 5-1 through 5-4 respectively.

5.4 Performance Test

5.4.2 Measuring Maximum Output Current

Connection

Connect the signal generator, AC voltmeter, oscilloscope and terminator resistance as shown in "Figure 5-2 Measuring Maximum Output Current."

Setting

Set the HSA4012/14/51/52 as follows:

Input changeover: "A"; input impedance: "600Ω"; bias addition: "OFF/dial 5.00"

	HSA4012	HSA4014	HSA4051	HSA4052
Gain setting	×20CAL	×20CAL	×40CAL	×40CAL
Voltage range	±75 V	±75 V	±150 V	±150 V
Terminator resistance	5Ω	2.5Ω	10Ω	5Ω

Test procedure

Select a sine wave as the waveform of the signal generator, adjust the frequency to 400 Hz and turn ON the output ON/OFF switch of the HSA4012/14/51/52. Gradually increase the output voltage of the signal generator from 0 V. Observe the waveform using an oscilloscope and record the output voltage when the waveform starts to clip.

The maximum output current is calculated as (output voltage / terminator resistance)

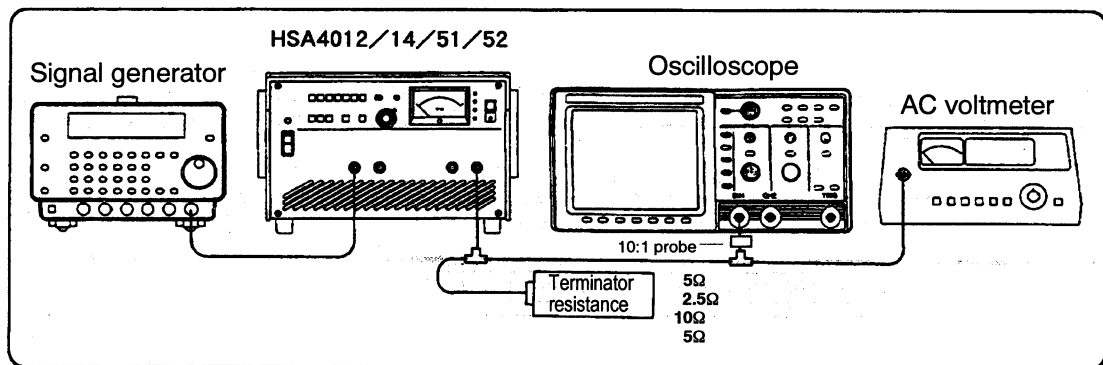

Figure 5-2 Measuring Maximum Output Current

Judgment criteria

The judgment criteria for each model is shown in the "Measurement of maximum output current" field in Tables 5-1 through 5-4 respectively.

5.4.3 Measuring Frequency Characteristic

Connection

Connect the 5090 frequency response analyzer (hereafter abbreviated as "FRA") and terminator resistance as shown in "Figure 5-3 Measuring Frequency Characteristic."

Setting

Set the HSA4012/14/51/52 as follows:

Input changeover: "A"; input impedance: "600 Ω "; bias addition: "OFF/dial 5.00"

	HSA4012	HSA4014	HSA4051	HSA4052
Gain setting	$\times 20\text{CAL}$	$\times 20\text{CAL}$	$\times 40\text{CAL}$	$\times 40\text{CAL}$
Voltage range	$\pm 75\text{ V}$	$\pm 75\text{ V}$	$\pm 150\text{ V}$	$\pm 150\text{ V}$
Terminator resistance	25 Ω	12.5 Ω	100 Ω	50 Ω

Set the FRA as follows:

Output: sine wave 0.77 V_{peak}; sweep frequency: 100 Hz to 1 MHz; log sweep;
analysis: ch1/ch2; display: logF-logR- θ

Test procedure

Turn ON the FRA output and let it perform UP (or DOWN) sweeps and measure from 100 Hz to 1 MHz. After the measurement, move the cursor and read the gain at 400 Hz, 100 kHz, 500 kHz and 1 MHz (in case of HSA4012/14). (At 400 Hz, 100 kHz, 300 kHz, 500 kHz in case of HSA4051/52)

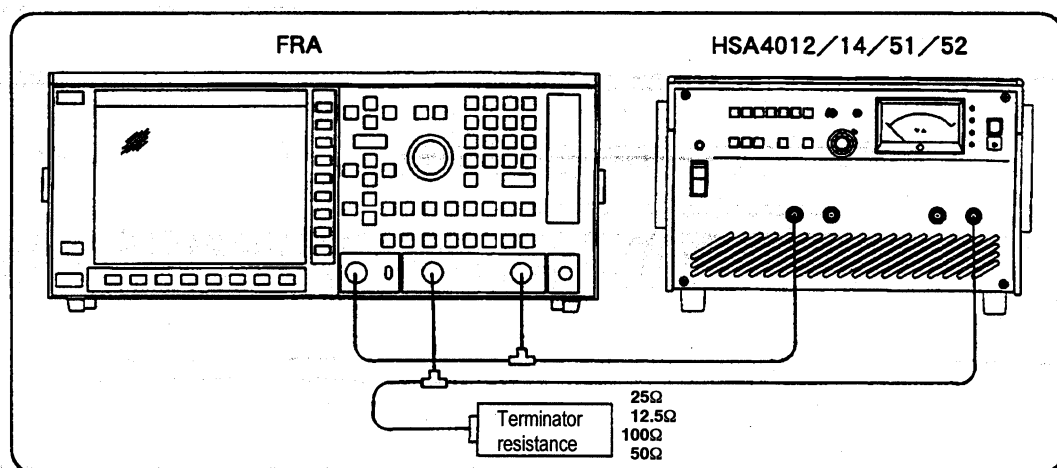

Figure 5-3 Measuring Frequency Characteristic

Judgment criteria

The judgment criteria for each model is shown in the "Measurement of frequency characteristic" field in Tables 5-1 through 5-4 respectively.

5.4 Performance Test

5.4.4 Measuring Gain Error

Connection

Connect the FRA and terminator resistance as shown in "Figure 5-3 Measuring Frequency Characteristic."

Setting

Set the HSA4012/14/51/52 as follows:

Input changeover: "A"; input impedance: "600Ω"; bias addition: "OFF/dial 5.00"

	HSA4012	HSA4014	HSA4051	HSA4052
Gain setting	×20CAL	×20CAL	×40CAL	×40CAL
Voltage range	±75 V	±75 V	±150 V	±150 V
Terminator resistance	25Ω	12.5Ω	100Ω	50Ω

Set the FRA as follows:

Output: sine wave; frequency: 400 Hz; analysis: ch1/ch2; display: logF–logR–θ

Test procedure

Set the gain of the HSA4012/14/51/52 and output voltage of the FRA as described in "Table 5-1 HSA4012 Judgment" to "Table 5-4 HSA4052 Judgment" and carry out measurement in continuous mode with the output of the FRA turned ON. (Carry out measurement at a voltage 80% of the maximum output voltage.)

Judgment criteria

The judgment criteria for each model is shown in the "Measurement of gain error" field in Tables 5-1 through 5-4 respectively.

5.4.5 Measuring Sine Wave Distortion Rate

Connection

Connect the low distortion oscillator, distortion meter, oscilloscope and terminator resistance as shown in "Figure 5-4 Measuring Sine Wave Distortion Rate."

Setting

Set the HSA4012/14/51/52 as follows:

Input changeover: "A"; gain ×20CAL (HSA4012/14), ×40CAL (HSA4051/52); input impedance: "600Ω"; bias addition: "OFF/dial 5.00"

	HSA4012	HSA4014	HSA4051	HSA4052
Gain setting	×20CAL	×20CAL	×40CAL	×40CAL
Voltage range	±75 V	±75 V	±150 V	±150 V
Terminator resistance	25Ω	12.5Ω	100Ω	50Ω

Test procedure

Adjust the output level of the low distortion oscillator so that the output voltage of the HSA4012/14/51/52 becomes 40 Vrms (in the case of the HSA4012/14 and 80 Vrms in the case of the HSA4051/52). Measure the sine wave distortion rate at frequencies 40 Hz, 1 kHz, 100 kHz and 500 kHz.

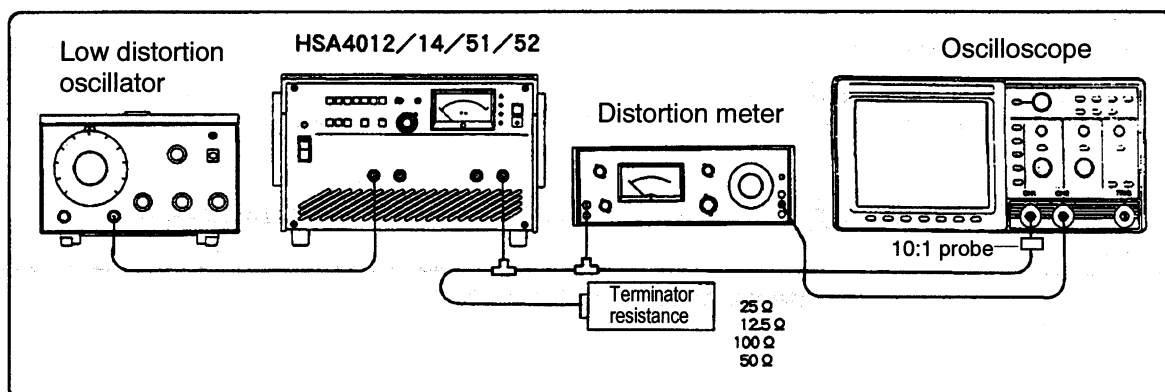

Figure 5-4 Measuring Sine Wave Distortion Rate

Judgment criteria

The judgment criteria for each model is shown in the "Measurement of sine wave distortion rate" field in Tables 5-1 through 5-4 respectively.

5.4.6 Measuring Bias Addition Voltage

Connection

Connect the digital voltmeter and terminator resistance as shown in "Figure 5-5 Measuring Bias Addition Voltage."

Setting

Set the HSA4012/14/51/52 as follows:

Input changeover: "A"; input impedance: "600Ω"; bias addition: "OFF/dial 5.00"

	HSA4012	HSA4014	HSA4051	HSA4052
Gain setting	×20CAL	×20CAL	×40CAL	×40CAL
Voltage range	±75 V	±75 V	±150 V	±150 V
Terminator resistance	25Ω	12.5Ω	100Ω	50Ω

5.4 Performance Test

Test procedure

Before testing, perform fine adjustment of the offset voltage of the HSA4012/14/51/52 to zero with special care. Turn ON bias addition of the HSA4012/14/51/52 and gradually change the dial from 5.00 and measure the output voltage when the scale is set to 2.00, 3.00, 5.00, 7.00 and 8.00.

After the measurement is completed, set bias addition "OFF/dial 5.00" for safety.

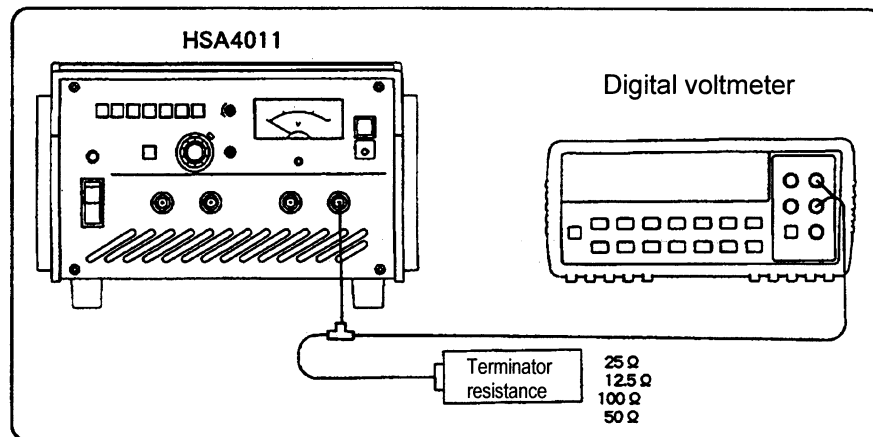

Figure 5-5 Measuring Bias Addition Voltage

Judgment criteria

The judgment criteria for each model is shown in the "Measurement of bias addition voltage" field in Tables 5-1 through 5-4 respectively.

The product passes the test if it meets the following judgment criteria.

Table 5-1 HSA4012 Judgment

Measurement of maximum output voltage (at 20 Hz, 40 Hz, 500 kHz, 1 MHz)	Setting frequency	Judgment criteria	Measured value	Judgment
	20 Hz	40 Vrms or more	__.'__	Acceptable/rejected
	40 Hz	50 Vrms or more	__.'__	Acceptable/rejected
	500 kHz	50 Vrms or more	__.'__	Acceptable/rejected
	1 MHz	40 Vrms or more	__.'__	Acceptable/rejected

Measurement of maximum output current (voltage at which waveform starts to clip at 400 Hz)	Frequency	Terminator resistance	Judgment criteria	Measured value	Judgment
	400 Hz	5Ω	10 Vrms or more	__.'__	Acceptable/rejected

Measurement of frequency characteristic at 100 kHz, 300 kHz, 1 MHz relative to 400 Hz (0 dB)	Setting frequency	Judgment criteria	Measured value	Judgment
	400 Hz	0 dB (reference)	0 . 0 0	Set this as reference
	100 kHz	-0.3 to +0.3 dB	__.'__	Acceptable/rejected
	300 kHz	-1.0 to +0.5 dB	__.'__	Acceptable/rejected
	1 MHz	-3.0 to +0.5 dB	__.'__	Acceptable/rejected

Measurement of gain error Gain ×10 CAL, ×20 CAL, ×50 CAL, ×100 CAL, ×100 UNCAL maximum	Setting gain	FRA output voltage	Judgment criteria	Measured value	Judgment
	×10CAL	6.1 Vpeak	9.5 to 10.5	__.'__	Acceptable/rejected
	×20CAL	3.0 Vpeak	19.0 to 21.0	__.'__	Acceptable/rejected
	×50CAL	1.2 Vpeak	47.5 to 52.5	__.'__	Acceptable/rejected
	×100CAL	0.6 Vpeak	95 to 105	__.'__	Acceptable/rejected
	×100UNCAL	0.2 Vpeak	300 or more	__.'__	Acceptable/rejected

Measurement of sine wave distortion rate (at each frequency)	Setting frequency	Judgment criteria	Measured value	Judgment
	40 Hz	0 to 0.1%	0. ___	Acceptable/rejected
	1 kHz	0 to 0.1%	0. ___	Acceptable/rejected
	100 kHz	0 to 1.0%	_. ___	Acceptable/rejected
	500 kHz	0 to 3.0%	._ ___	Acceptable/rejected

Measurement of bias addition voltage (at each dial memory)	Dial setting	Judgment criteria	Measured value	Judgment
	2.00	-63.4 to -60.0	-__.'__	Acceptable/rejected
	3.00	-42.6 to -40.0	-__.'__	Acceptable/rejected
	5.00	-1.0 to +1.0	__.'__	Acceptable/rejected
	7.00	+40.0 to +42.6	+__.'__	Acceptable/rejected
	8.00	+60.0 to +63.4	+__.'__	Acceptable/rejected

5.4 Performance Test

The product passes the test if it meets the following judgment criteria.

Table 5-2 HSA4014 Judgment

Measurement of maximum output voltage (at 20 Hz, 40 Hz, 500 kHz, 1 MHz)	Setting frequency	Judgment criteria	Measured value	Judgment
	20 Hz	40 Vrms or more	__.'__	Acceptable/rejected
	40 Hz	50 Vrms or more	__.'__	Acceptable/rejected
	500 kHz	50 Vrms or more	__.'__	Acceptable/rejected
	1 MHz	40 Vrms or more	__.'__	Acceptable/rejected

Measurement of maximum output current (voltage at which waveform starts to clip at 400 Hz)	Frequency	Terminator resistance	Judgment criteria	Measured value	Judgment
	400 Hz	2.5Ω	10 Vrms or more	__.'__	Acceptable/rejected

Measurement of frequency characteristic at 100 kHz, 300 kHz, 1 MHz relative to 400 Hz (0 dB)	Setting frequency	Judgment criteria	Measured value	Judgment
	400 Hz	0 dB (reference)	0.00	Set this as reference
	100 kHz	-0.3 to 0.3 dB	__.'__	Acceptable/rejected
	300 kHz	-1.0 to 0.5 dB	__.'__	Acceptable/rejected
	1 MHz	-3.0 to 0.5 dB	__.'__	Acceptable/rejected

Measurement of gain error Gain ×10 CAL, ×20 CAL, ×50 CAL, ×100 CAL, ×100 UNCAL maximum	Setting gain	FRA output voltage	Judgment criteria	Measured value	Judgment
	×10CAL	6.1 Vpeak	9.5 to 10.5	__.'__	Acceptable/rejected
	×20CAL	3.0 Vpeak	19.0 to 21.0	__.'__	Acceptable/rejected
	×50CAL	1.2 Vpeak	47.5 to 52.5	__.'__	Acceptable/rejected
	×100CAL	0.6 Vpeak	95 to 105	__.'__	Acceptable/rejected
	×100UNCAL	0.2 Vpeak	300 or more	__.'__	Acceptable/rejected

Measurement of sine wave distortion rate (at each frequency)	Setting frequency	Judgment criteria	Measured value	Judgment
	40 Hz	0 to 0.1%	0. ___	Acceptable/rejected
	1 kHz	0 to 0.1%	0. ___	Acceptable/rejected
	100 kHz	0 to 0.1%	_. ___	Acceptable/rejected
	500 kHz	0 to 3.0%	_. ___	Acceptable/rejected

Measurement of bias addition voltage (at each dial memory)	Dial setting	Judgment criteria	Measured value	Judgment
	2.00	-63.4 to -60.0	-__.'__	Acceptable/rejected
	3.00	-42.6 to -40.0	-__.'__	Acceptable/rejected
	5.00	-1.0 to +1.0	__.'__	Acceptable/rejected
	7.00	+40.0 to +42.6	+__.'__	Acceptable/rejected
	8.00	+60.0 to +63.4	+__.'__	Acceptable/rejected

The product passes the test if it meets the following judgment criteria.

Table 5-3 HSA4051 Judgment

Measurement of maximum output voltage (at 20 Hz, 40 Hz, 200 kHz, 500 kHz)	Setting frequency	Judgment criteria	Measured value	Judgment
	20 Hz	40 Vrms or more	___. __	Acceptable/rejected
	40 Hz	100 Vrms or more	___. __	Acceptable/rejected
	200 kHz	100 Vrms or more	___. __	Acceptable/rejected
	500 kHz	40 Vrms or more	___. __	Acceptable/rejected

Measurement of maximum output current (voltage at which waveform starts to clip at 400 Hz)	Frequency	Terminator resistance	Judgment criteria	Measured value	Judgment
	400 Hz	10 Ω	10 Vrms or more	___. __	Acceptable/rejected

Measurement of frequency characteristic at 100 kHz, 300 kHz, 500 kHz relative to 400 Hz (0 dB)	Setting frequency	Judgment criteria	Measured value	Judgment
	400 Hz	0 dB (reference)	0 . 0 0	Set this as reference
	100 kHz	-0.3 to +0.3 dB	___. __	Acceptable/rejected
	300 kHz	-1.0 to +0.5 dB	___. __	Acceptable/rejected
	500 kHz	-3.0 to +0.5 dB	___. __	Acceptable/rejected

Measurement of gain error Gain $\times 20$ CAL, $\times 40$ CAL, $\times 100$ CAL, $\times 200$ CAL, $\times 200$ UNCAL maximum	Setting gain	FRA output voltage	Judgment criteria	Measured value	Judgment
	$\times 20$ CAL	3.0 Vpeak	19.0 to 21.0	___. __	Acceptable/rejected
	$\times 40$ CAL	1.5 Vpeak	38.0 to 42.0	___. __	Acceptable/rejected
	$\times 100$ CAL	0.6 Vpeak	95 to 105	___. __	Acceptable/rejected
	$\times 200$ CAL	0.3 Vpeak	190 to 210	___. __	Acceptable/rejected
	$\times 200$ UNCAL	0.1 Vpeak	600 or more	___. __	Acceptable/rejected

Measurement of sine wave distortion rate (at each frequency)	Setting frequency	Judgment criteria	Measured value	Judgment
	40 Hz	0 to 0.1%	0. ___	Acceptable/rejected
	1 kHz	0 to 0.1%	0. ___	Acceptable/rejected
	100 kHz	0 to 0.1%	_. ___	Acceptable/rejected
	500 kHz	0 to 3.0%	_. ___	Acceptable/rejected

Measurement of bias addition voltage (at each dial memory)	Dial setting	Judgment criteria	Measured value	Judgment
	2.00	-125.8 to -120.0	-___. __	Acceptable/rejected
	3.00	-84.2 to -80.0	-___. __	Acceptable/rejected
	5.00	-1.0 to +1.0	___. __	Acceptable/rejected
	7.00	+80.0 to +84.2	+___. __	Acceptable/rejected
	8.00	+120.0 to +125.8	+___. __	Acceptable/rejected

5.4 Performance Test

The product passes the test if it meets the following judgment criteria.

Table 5-4 HSA4052 Judgment

Measurement of maximum output voltage (at 20 Hz, 40 Hz, 200 kHz, 500 kHz)	Setting frequency	Judgment criteria	Measured value	Judgment
	20 Hz	40 Vrms or more	___.__	Acceptable/rejected
	40 Hz	100 Vrms or more	___.__	Acceptable/rejected
	200 kHz	100 Vrms or more	___.__	Acceptable/rejected
	500 kHz	40 Vrms or more	___.__	Acceptable/rejected

Measurement of maximum output current (voltage at which waveform starts to clip at 400 Hz)	Frequency	Terminator resistance	Judgment criteria	Measured value	Judgment
	400 Hz	5Ω	10 Vrms or more	___.__	Acceptable/rejected

Measurement of frequency characteristic at 100 kHz, 300 kHz, 500 kHz relative to 400 Hz (0 dB)	Setting frequency	Judgment criteria	Measured value	Judgment
	400 Hz	0 dB (reference)	0.00	Set this as reference
	100 kHz	-0.3 to +0.3 dB	___.__	Acceptable/rejected
	300 kHz	-1.0 to +0.5 dB	___.__	Acceptable/rejected
	500 kHz	-3.0 to +0.5 dB	___.__	Acceptable/rejected

Measurement of gain error Gain ×20 CAL, ×40 CAL, ×100 CAL, ×200 CAL, ×200 UNCAL maximum	Setting gain	FRA output voltage	Judgment criteria	Measured value	Judgment
	×20CAL	3.0 Vpeak	19.0 to 21.0	___.__	Acceptable/rejected
	×40CAL	1.5 Vpeak	38.0 to 42.0	___.__	Acceptable/rejected
	×100CAL	0.6 Vpeak	95 to 105	___.__	Acceptable/rejected
	×200CAL	0.3 Vpeak	190 to 210	___.__	Acceptable/rejected
	×200UNCAL	0.1 Vpeak	600 or more	___.__	Acceptable/rejected

Measurement of sine wave distortion rate (at each frequency)	Setting frequency	Judgment criteria	Measured value	Judgment
	40 Hz	0 to 0.1%	0.____	Acceptable/rejected
	1 kHz	0 to 0.1%	0.____	Acceptable/rejected
	100 kHz	0 to 0.1%	_.____	Acceptable/rejected
	500 kHz	0 to 3.0%	_.____	Acceptable/rejected

Measurement of bias addition voltage (at each dial memory)	Dial setting	Judgment criteria	Measured value	Judgment
	2.00	-125.8 to -120.0	-___.__	Acceptable/rejected
	3.00	-84.2 to -80.0	-___.__	Acceptable/rejected
	5.00	-1.0 to +1.0	___.__	Acceptable/rejected
	7.00	+80.0 to +84.2	+___.__	Acceptable/rejected
	8.00	+120.0 to +125.8	+___.__	Acceptable/rejected

5.5 Handling Apparent Faults

The product may be suspected to be malfunctioning if the following phenomena occur. Take the "necessary action." If the product is not recovered from these phenomena, contact us or our sales agency.

Table 5-5 Apparent Faults

Phenomenon	Possible cause	Necessary action
No operation on power up	Fuse is blown out.	Replace the fuse with a normal one.
	Power line is not connected.	Securely insert the power cord into the plug.
No output	Signal is not connected.	Connect the signal generator and securely push the input selection push button switch.
	Input is not selected.	
	Output ON/OFF switch is not turned ON.	Turn ON the output ON/OFF switch.
Overload lamp turns ON	Overload?	Remove the load and if the overload lamp turns OFF, connect a load within the range of maximum output.
	Signal level of signal generator is excessive.	Reduce the level of the signal generator connected.
	Is gain setting correct?	Set the gain setting switch to an appropriate range.
DC appears on output	Bias addition switch is ON.	Turn OFF the bias addition switch.
	Is DC superimposed on signal source?	Set the DC component of the signal generator to 0.

6. Specifications

The specifications of the HSA4012/14/51/52 are described separately for each model only when they vary depending on the model.

Hereafter, suppose the rated load of each model is:

HSA4012 (25 Ω), HSA4014 (12.5 Ω), HSA4051 (100 Ω), HSA4052 (50 Ω)

6.1 Input

Input type

Input A, input B or addition of input A and input B

Input impedance

50 Ω or 600 Ω within $\pm 5\%$

Maximum allowable input voltage

± 10 V

Connector

BNC-R

1 for front and 1 for rear panel for both inputs A and B

6.2 Output

6.2 Output

Maximum output voltage

HSA4012	HSA4014	HSA4051	HSA4052
±75 V range 50 Vrms or above, 40 Hz to 500 kHz 40 Vrms or above, 20 Hz to 1 MHz		±150 V range 100 Vrms or above, 40 Hz to 200 kHz 40 Vrms or above, 20 Hz to 500 kHz	
25Ω load	12.5Ω load	100Ω load	50Ω load
±75 V range ±75 V (150 Vp-p) DC to 100 kHz ±70 V (140 Vp-p) DC to 500 kHz ±55 V (110 Vp-p) DC to 1 MHz		±150 V range ±150 V (300 Vp-p) DC to 50 kHz ±140 V (280 Vp-p) DC to 200 kHz ±55 V (110 Vp-p) DC to 500 kHz	
75Ω load	37.5Ω load	300Ω load	150Ω load
-25 to +125 V range -25 to +125 V (150 Vp-p) DC to 100 kHz -20 to +120 V (140 Vp-p) DC to 500 kHz -5 to +10 V (110 Vp-p) DC to 1 MHz		-50 to +250 V range -250 to +50 V (300 Vp-p) DC to 50 kHz -240 to +40 V (280 Vp-p) DC to 200 kHz -155 to -45 V (110 Vp-p) DC to 500 kHz	
125Ω load	62.5Ω load	500Ω load	250Ω load
-125 to +25 V range -125 to +25 V (150 Vp-p) DC to 100 kHz -120 to +20 V (140 Vp-p) DC to 500 kHz -105 to +5 V (110 Vp-p) DC to 1 MHz		-50 to +250 V range -250 to +50 V (300 Vp-p) DC to 50 kHz -240 to +40 V (280 Vp-p) DC to 200 kHz -155 to -45 V (110 Vp-p) DC to 500 kHz	
125Ω load	62.5Ω load	500Ω load	250Ω load

Maximum output current

HSA4012	HSA4014	HSA4051	HSA4052
2 Arms (5.66 Ap-p) 40 Hz to 500 kHz	4 Arms (11.3 Ap-p) 40 Hz to 500 kHz	1 Arms (2.83 Ap-p) 40 Hz to 200 kHz	2 Arms (5.66 Ap-p) 40 Hz to 200 kHz
±1.0A DC to 40 Hz	±2.0A DC to 40 Hz	±0.5A DC to 40 Hz	±1.0A DC to 40 Hz

Area of voltage and current that can be output

The maximum output current of the HSA4012/14/51/52 is restricted by frequency and output voltage. Moreover, the operation area also changes whether the current is a peak value or average value (DC).

- ☞ HSA4012 See "Figure 4-1 HSA4012 Operation Area."
- HSA4014 See "Figure 4-2 HSA4014 Operation Area."
- HSA4051 See "Figure 4-3 HSA4051 Operation Area."
- HSA4052 See "Figure 4-4 HSA4052 Operation Area."

Output impedance

HSA4012	HSA4014	HSA4051	HSA4052
0.25Ω +0.8μH or less	0.125Ω +0.4μH or less	1Ω +3.2μH or less	0.5Ω +1.6μH or less

Output noise level **NOTE** G: Gain setting

Within $(1 + 0.4G)mV_{rms}$

With input shorted, rated load and frequency band of 10 Hz to 1 MHz

Output DC offset voltage

Adjustable to 0 using pre-set variable resistor

Adjustment range

HSA4012	HSA4014	HSA4051	HSA4052
±0.5 V or more		±1.0 V or more	

Temperature drift: $\pm(1 + 0.1G)mV/°C$ typ **NOTE** G: Gain setting

DC bias

Using ON/OFF switch and 10-turn potentiometer

Setting range

HSA4012	HSA4014	HSA4051	HSA4052
±100 V or more		±200 V or more	

Main Output connector

BNC-R: 1 for front and 1 for rear

GND connected to chassis

6.2 Output

Voltage monitor output

Output impedance: $500\Omega \pm 5\%$
 Load impedance: $10\text{ k}\Omega$ or more
 Gain: (Main output) $\div 100 \pm 10\%$ (no load)
 Phase: In-phase with respect to input
 Output connector: BNC-R front panel

Monitor meter

Display: Display by switching between voltage/current
 Function: Indicates average value of output voltage DC+AC
 Detection system: Average value detection, calibrated with sine wave
 Full scale

HSA4012	HSA4014	HSA4051	HSA4052
Voltage: 150 V Current: 2.5 A	Voltage: 150 V Current: 5.0 A	Voltage: 300 V Current: 1.2 A	Voltage: 300 V Current: 2.5 A

Accuracy: Within $\pm 10\%$ of full scale

HSA4012	HSA4014	HSA4051	HSA4052
Voltage: At DC to 1 MHz Current: At DC to 10 kHz		Voltage: At DC to 500 kHz Current: At DC to 5 kHz	

Preamp output

Output impedance: $150\Omega \pm 5\%$
 Load impedance: 600Ω or more
 Gain: (Main output) $\div 15.6 \pm 5\%$

HSA4012	HSA4014	HSA4051	HSA4052
(Main output) $\div 15.6 \pm 5\%$		(Main output) $\div 31.2 \pm 5\%$	

Phase: Inverse phase with respect to input
 Output connector: BNC-R rear panel

6.3 Input/Output Characteristic

Gain

Function

HSA4012	HSA4014	HSA4051	HSA4052
Combination of four ranges of $\times 10$, $\times 20$, $\times 50$, $\times 100$ and pre-set variable resistor provides variable gain from $\times 10$ to $\times 300$.		Combination of four ranges of $\times 20$, $\times 40$, $\times 100$, $\times 200$ and pre-set variable resistor provides variable gain from $\times 20$ to $\times 600$.	

Error: $\pm 5\%$ (frequency 400 Hz, variable setting CAL position)

Small signal frequency characteristic

HSA4012	HSA4014	HSA4051	HSA4052
Within ± 0.3 dB	At DC to 100 kHz	Within ± 0.3 dB	At DC to 100 kHz
Within -1 to $+0.5$ dB	At 100 k to 300 kHz	Within -1 to $+0.5$ dB	At 100 k to 300 kHz
Within -3 to $+0.5$ dB	At 300 k to 1 MHz	Within -3 to $+0.5$ dB	At 300 k to 500 kHz
(Variable gain setting: CAL, 400 Hz reference, 10 Vrms output, rated load)		(Variable gain setting: CAL, 400 Hz reference, 20 Vrms output, rated load)	

Step response

Overshoot/sag: 5% or less

Through rate

HSA4012	HSA4014	HSA4051	HSA4052
400 V/ μ s typ		450 V/ μ s typ	
With output voltage ± 50 V, rated load		With output voltage ± 100 V, rated load	

Harmonics distortion rate

HSA4012	HSA4014	HSA4051	HSA4052
0.1% or less 40 Hz to 1 kHz		0.1% or less 40 Hz to 1 kHz	
1% or less 40 Hz to 100 kHz		1% or less 40 Hz to 100 kHz	
(With output voltage 40 Vrms, rated load)		(With output voltage 80 Vrms, rated load)	
-30 dB or less 40 Hz to 1 MHz		3.0% or less 40 Hz to 500 kHz	
(With output voltage 30 Vrms, rated load)		(With output voltage 30 Vrms, rated load)	

Phase between input/output: In-phase with respect to inputs A and B

6.4 General Specifications

6.4 General Specifications

Power supply

Rated frequency: 50/60 Hz

Frequency range: 48 to 62 Hz

Rated voltage: Single-phase 100/120/200/240 V
120 V, 200 V and 240 V are option at shipment

Voltage range: 100 V: 90 to 110 V
120 V: 108 to 132 V
200 V: 180 to 220 V
240 V: 216 to 250 V

Power consumption: At 100 V, 50 Hz

HSA4012	HSA4014	HSA4051	HSA4052
No load		No load	
230 W or less 300 VA or less	390 W or less 500 VA or less	230 W or less 300 VA or less	390 W or less 500 VA or less
With rated output (50 Vrms, 400 Hz, rated load)		With rated output (100 Vrms, 400 Hz, rated load)	
340 W or less 450 VA or less	700 W or less 900 VA or less	340 W or less 500 VA or less	700 W or less 950 VA or less

Insulation/withstand voltage

Insulation: Between power input and chassis, other total: 30 MΩ or more at DC 500 V

Withstand voltage: Between power input and chassis, other total: 1500 VAC/1 minute

Temperature range/humidity range

During operation: 0 to +40°C, 10 to 90% RH

During storage: -20 to +50°C, 10 to 80% RH

External dimensions/weight

☞ For details, see "Figure 6-1 HSA4012 External Dimensions" to "Figure 6-4 HSA4052 External Dimensions."

	W (mm)	H (mm)	D (mm)
HSA4012	308	148.5	538
HSA4014	308	193	538
HSA4051	308	148.5	538
HSA4052	308	193	538

Weight

HSA4012	HSA4014	HSA4051	HSA4052
Approximately 13 kg	Approximately 18 kg	Approximately 13 kg	Approximately 18 kg

6.5 Option

Rack mount bracket

The HSA4012/14/51/52 can be mounted on a standard millimeter or inch rack using auxiliary brackets. Contact our sales representative specifying either millimeter or inch.

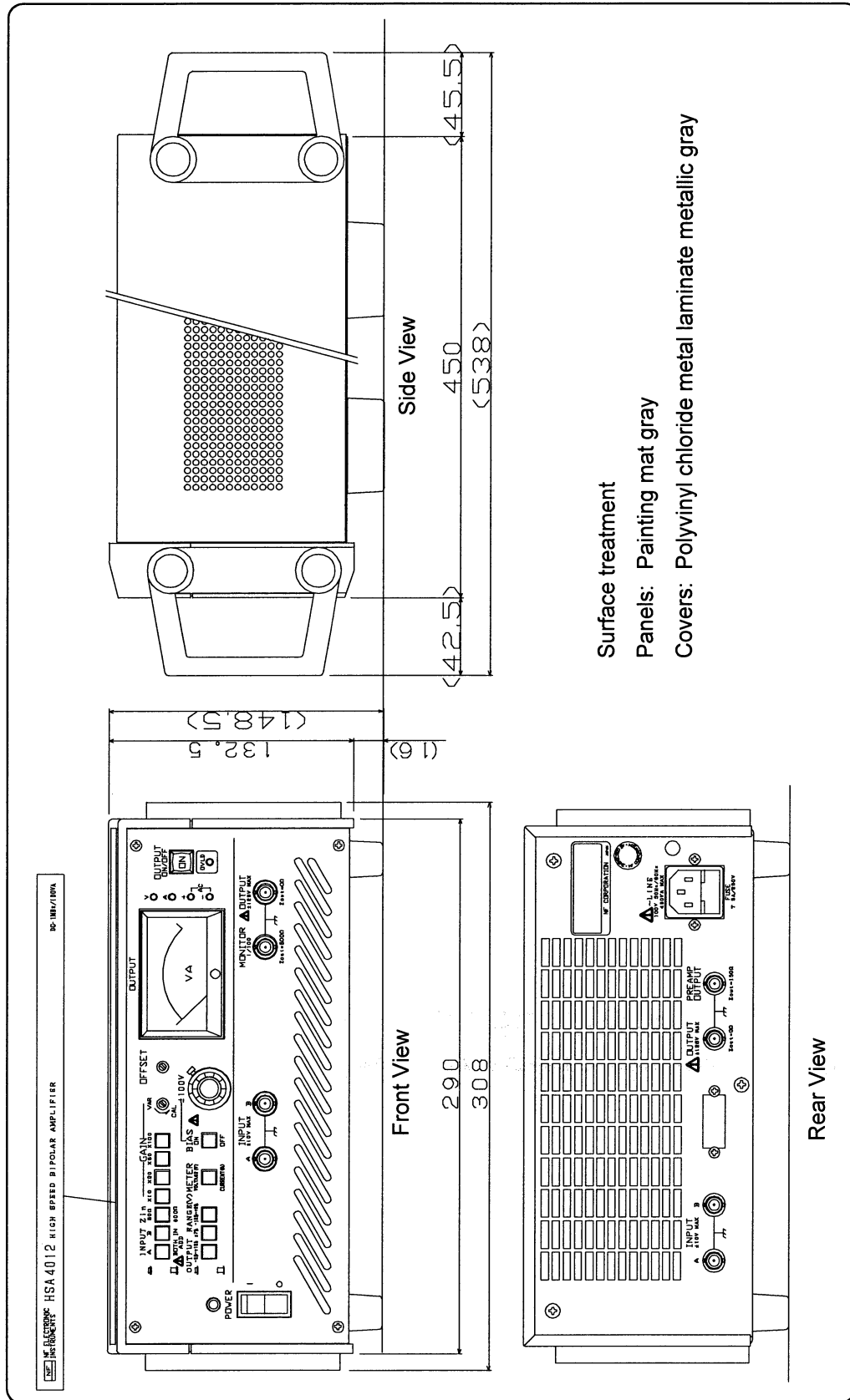

Figure 6-1 HSA4012 External Dimensions

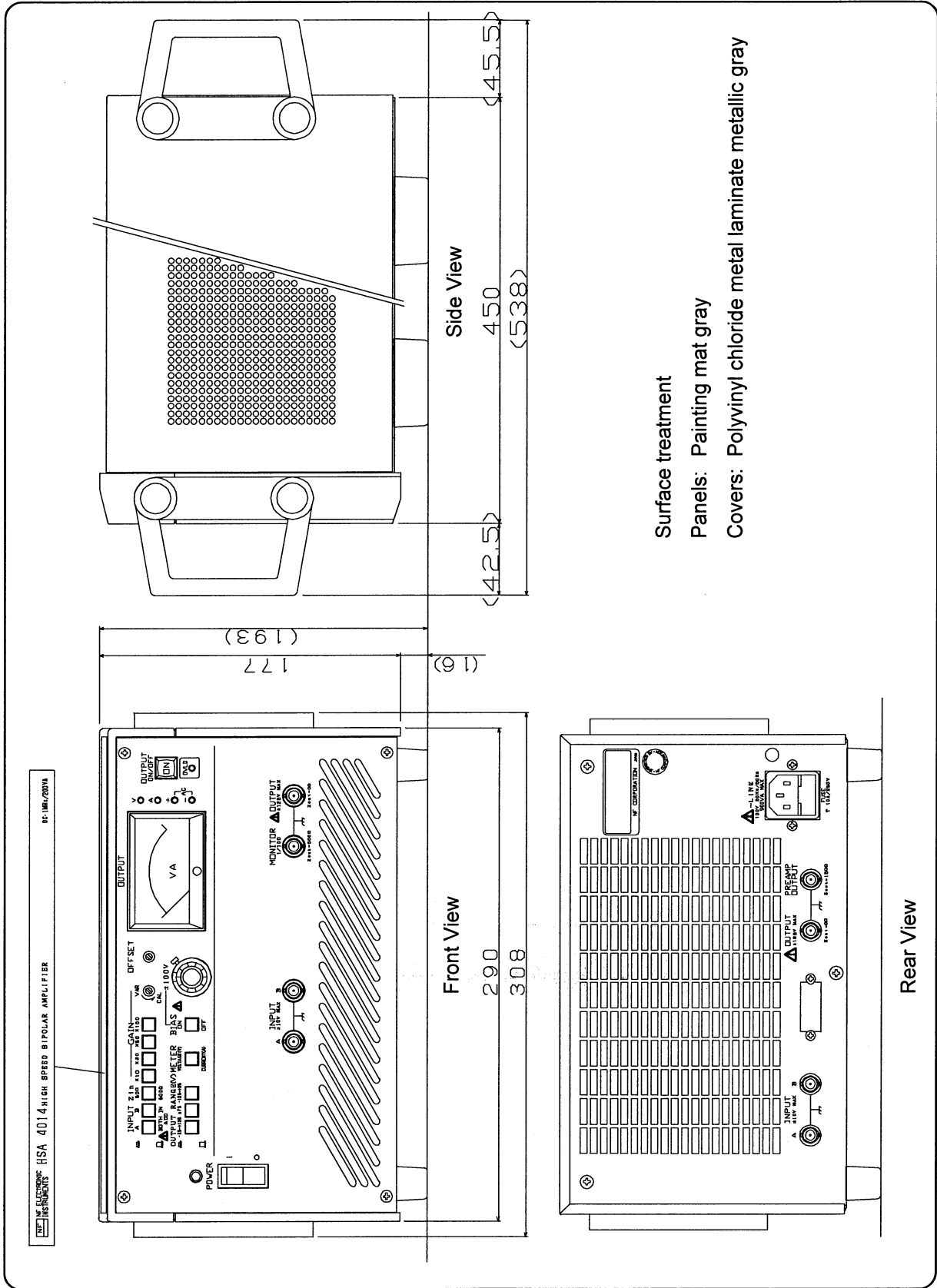

Figure 6-2 HSA4014 External Dimensions

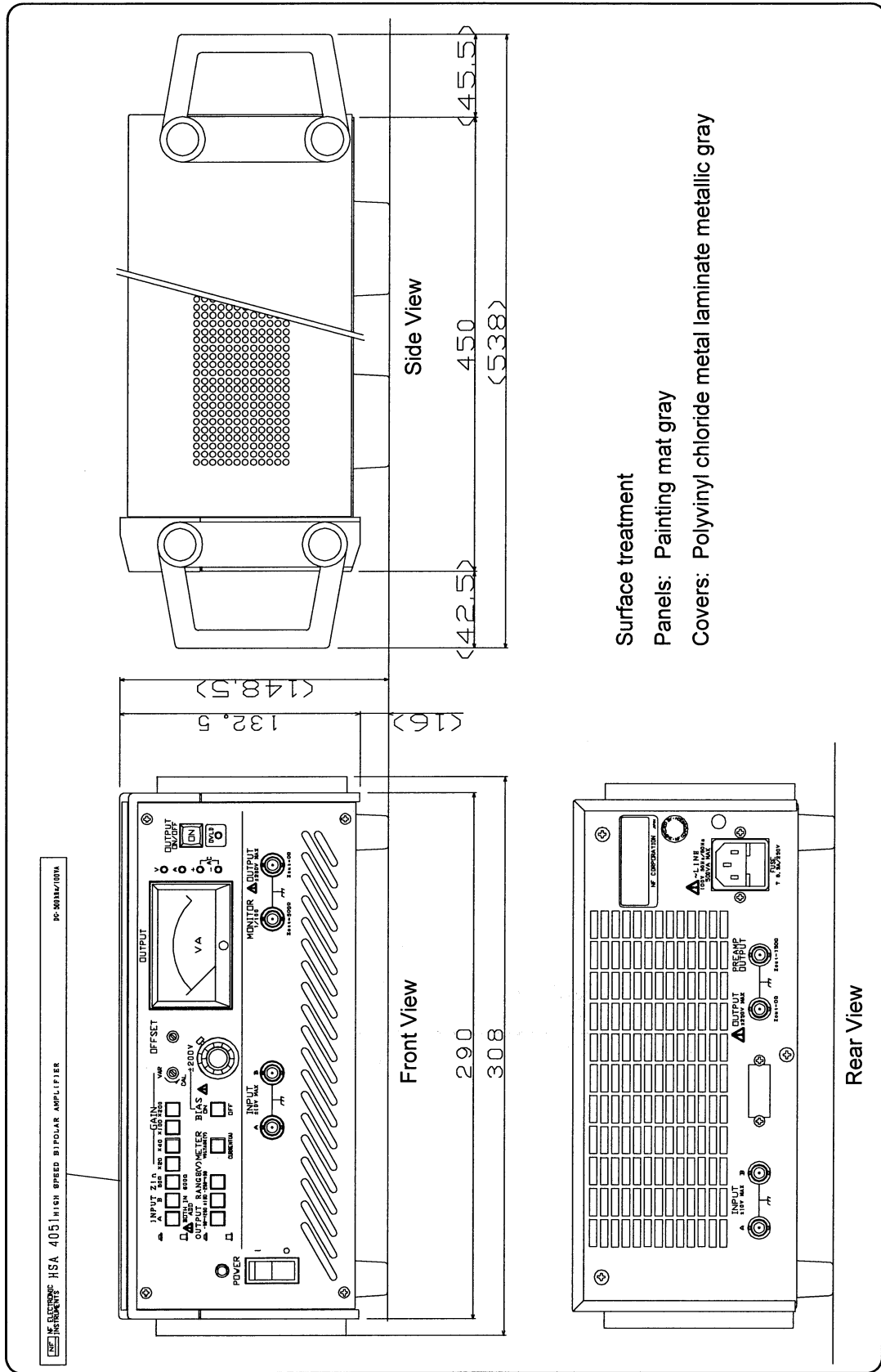

Figure 6-3 HSA4051 External Dimensions

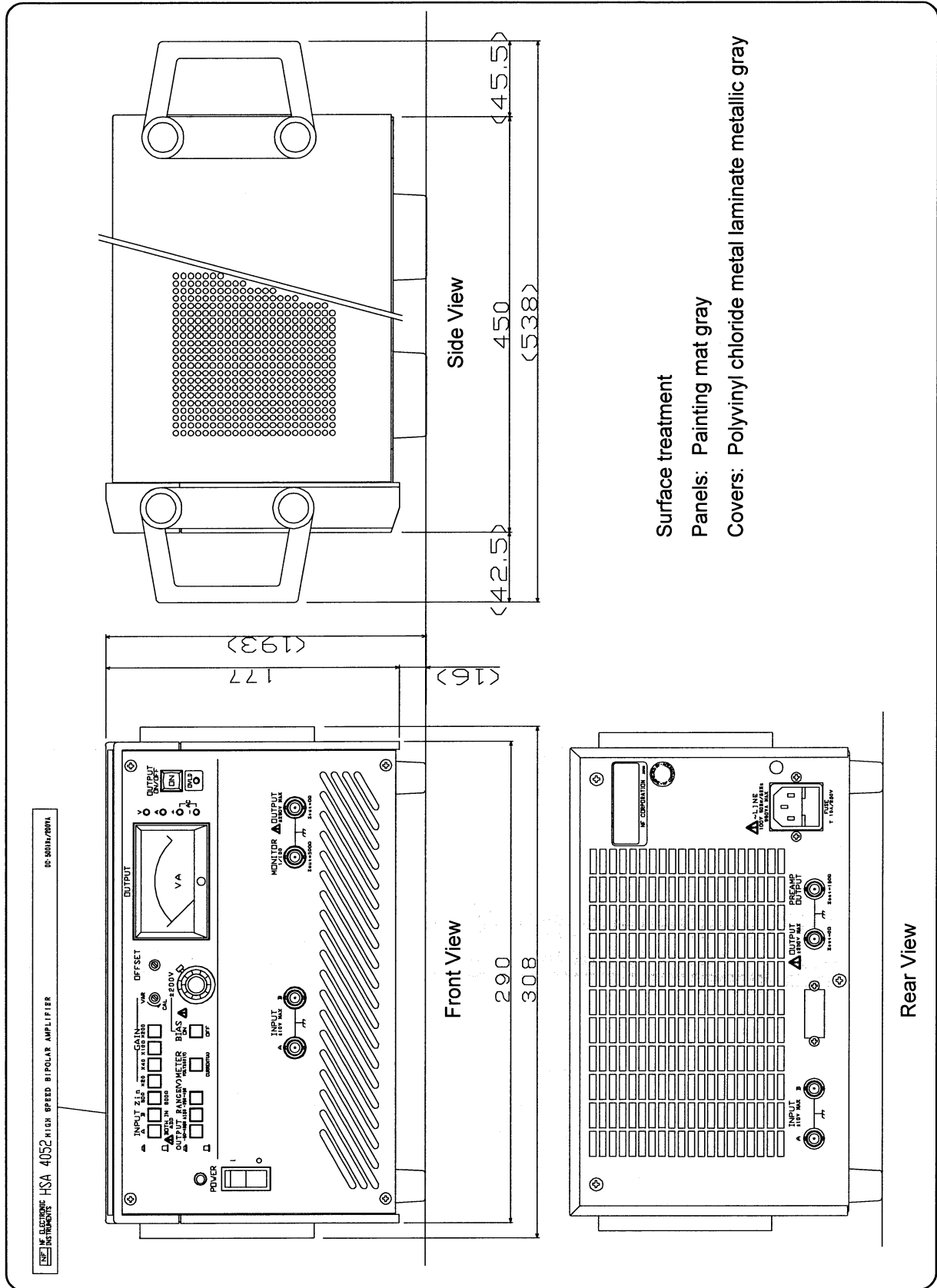

Figure 6-4 HSA4052 External Dimensions

WARRANTY

NF CORPORATION certifies that this instrument was thoroughly tested and inspected and found to meet its published specifications when it was shipped from our factory.

All **NF** products are warranted against defects in materials and workmanship for a period of one year from the date shipment. During the warranty period of, **NF** will, at its option, either will repair the defective product without any charge for the parts and labor, or either repair or replace products which prove to be defective. For repair service under warranty, the product must be returned to a service center designated by **NF**. Purchaser shall be prepay shipping charge, duties, and taxes for the product to **NF** from another country, and **NF** shall pay shipping charge to returned the product to purchaser.

This warranty shall not apply to any defect, failure or damage caused by improper use, improper or inadequate maintenance and care or modified by purchaser or personnel other than **NF** representatives.

NF CORPORATION

If there are any misplaced or missing pages, we will replace the manual. Contact the sales representative.

NOTES

- Reproduction of the contents of this manual is forbidden by applicable laws.
- The contents of this manual may be revised without notice.
- Information provided in this manual is intended to be accurate and reliable. However, we assume no responsibility for any damage regarding the contents of this manual.
- We assume no responsibility for influences resulting from the operations in this manual.

Copyright 2000, *NF CORPORATION*

NF CORPORATION

3-20 Tsunashima Higashi 6-chome, Kohoku-ku. Yokohama-shi
223-8508, JAPAN

Phone: 81-45-545-8128 Fax:81-45-545-8187 Telex: 3823-297

