



HIGH SPEED BIPOLAR AMPLIFIER

HSA4011

OPERATION MANUAL

D : 509646 - 1

HSA4011
HIGH SPEED BIPOLAR AMPLIFIER
Operation Manual

Foreword

Thank you very much for procuring HSA4011 HIGH SPEED BIPOLAR AMPLIFIER. At the outset, please take a few minutes to read the Safety Precautions indicated in this manual in order to use HSA4011 safely and correctly.

- **Warning and Caution notices**

The following Warning and Caution notices appear in this manual. These must be observed in order to protect both the user from physical harm and the equipment from damage.

 **WARNING**

Risk of serious and possibly fatal physical injury from electric shock or other cause.

 **CAUTION**

Risk of damage to the equipment.

- **Manual composition**

Please read Section 1 before using the equipment for the first time.

Section 1 Overview

Describes an outline, features, applications, functions and an outline of the principle of operation.

Section 2 Preparation

Required preparatory work before installing and operating the equipment.
Be sure to read this section.

Section 3 Description of Panel and Basic Operations

Describes the functions, operations and basic operations of the dials on the panel.
Read while operating the equipment.

Section 4 Applications

Expanded operations are described.

Section 5 Maintenance

Describes the methods of storage, repacking, transportation and corrective measures when abnormalities occur.

Section 6 Specifications

Equipment specifications (functions and performance) are described.

Safety Precautions

Observe the following warnings and cautions in order to use this equipment safely. No responsibility or warranty is assumed for damages arising from use in a manner contrary to these warnings and cautions.

HSA4011 belongs to Class I of insulation ratings by IEC standards (equipped with a protective grounding terminal).

- **Observe text instructions**

This manual has been compiled in order to enable safe operation and use of HSA4011. Be sure to read this manual before using the equipment.

Items designated by Warning advise of serious physical hazards. Be sure to observe these carefully.

- **Be sure to connect ground**

To prevent electric shock, securely connect the equipment to a ground.

Be sure to properly connect the ground. By connecting the 3 conductor power cable to a grounded 3-terminal wall socket, HSA4011 is automatically grounded.

- **Confirm power source voltage**

The HSA4011 operates at a supply voltage described in "2.4 Power Supply and Grounding".

Before connecting this equipment, check that the proper voltage is being supplied to the wall power outlet.

- **Observe the fuse rating**

Danger of fire, etc. Use the rated fuse specified in "2.4 Power Supply and Grounding."

When replacing the fuse, be sure to pull out the power cord from the receptacle.

- **Whenever you feel any abnormality, stop operating the equipment**

In event smoke, peculiar odor or noise is emitted, immediately disconnect the power source and avoid further operation.

Whenever such an abnormality occurs, prevent the equipment from being used until it is completely repaired and immediately contact us or our sales agency.

- **Flammable gas**

Do not use this equipment in an inflammable gas. There is danger of fire and explosion.

- **Do not remove covers**

HSA4011 contains dangerously high voltages. Do not remove external covers.

No persons other than trained service technicians who are familiar with danger prevention should perform inspection of the interior of the HSA4011.

- **Do not modify**

Do not replace or modify the HSA4011 in a way other than that specified by NF CORPORATION under any circumstances.

There is risk of personnel hazard and damage to the equipment . The manufacturer reserves the option of refusing service in such cases.

- **Prevention of electric shock by output voltage of HSA4011**

The maximum output of the HSA4011 is 50 Vrms (± 75 V)/1 Arms. Be careful to avoid electric shock.

Directly touching the output or changing the cord connection while the output is ON may cause electric shock.

- **Caution on use of high frequency signal**



Note that use of devices producing electromagnetic waves in a radio frequency band is restricted by laws and regulations in some countries.

- **Safety related symbols and indications**

Following are general definitions of the symbols and indications used in the text and on HSA4011.



Operation manual reference symbol

Advises of possible hazard to the user, as well as the need to consult this manual when using an operation or function



Warning symbol

Appears in the text and on the product to advise risk of fatal or otherwise serious physical injury.



Cautionary symbol

Appears in the text and on the product to advise risk of damage to the product.

Contents

Foreword

Safety Precautions

1. Overview	1-1
1.1 Overview	1-1
1.2 Features	1-2
1.3 Applications	1-3
1.4 Function List	1-4
1.5 Principle of Operation	1-5
2. Preparation	2-1
2.1 Appearance and Accessory Check	2-1
2.2 Configuration	2-1
2.3 Assembly and Installation	2-2
2.4 Power Supply and Grounding	2-3
2.5 Simple Operation Check	2-5
2.6 Calibration	2-6
3. Description of Panel and Basic Operations	3-1
3.1 Names and Operations of Panel Components	3-1
3.2 Display on Power Up and Initial Setting	3-4
3.3 Input/Output Terminals	3-4
3.4 Input/Output Connection	3-6
3.5 Basic Operation Example	3-7
4. Applications	4-1
4.1 Maximum Output Current and Operation Area	4-1
4.2 Increase of Output by Balanced Output	4-3
5. Maintenance	5-1
5.1 Introduction	5-1
5.2 Daily Care	5-1
5.3 Storage, Repacking and Transport	5-1
5.4 Performance Test	5-2
5.4.1 Measuring Maximum Output Voltage	5-3
5.4.2 Measuring Maximum Output Current	5-4
5.4.3 Measuring Frequency Characteristic	5-5
5.4.4 Measuring Gain Error	5-6
5.4.5 Measuring Sine Wave Distortion Rate	5-7
5.4.6 Measuring Bias Addition Voltage	5-8
5.5 Handling Apparent Faults	5-9

- 6. Specifications 6-1
 - 6.1 Input 6-1
 - 6.2 Output 6-1
 - 6.3 Input/Output Characteristic 6-3
 - 6.4 General Specifications 6-4
 - 6.5 Option 6-4

Figure

Figure 1-1	Block Diagram	1-5
Figure 2-1	Replacement of Fuse	2-4
Figure 2-2	Connection of Power Supply Connector	2-4
Figure 2-3	Standard Connection Diagram	2-6
Figure 3-1	Front/Rear View of Panel	3-3
Figure 3-2	Main Output & Monitor Output	3-5
Figure 3-3	Preamp Output	3-5
Figure 3-4	Basic Connection Diagram	3-6
Figure 4-1	Operation Area	4-1
Figure 4-2	Current Waveform Asymmetric between Positive and Negative Polarities	4-2
Figure 4-3	Connection of Balanced Output	4-3
Figure 5-1	Maximum Output Check	5-3
Figure 5-2	Maximum Output Current Check	5-4
Figure 5-3	Measuring Frequency Characteristic	5-5
Figure 5-4	Measuring Sine Wave Distortion Rate	5-7
Figure 5-5	Measuring Bias Addition Voltage	5-8
Figure 6-1	External Dimensions	6-5

Table

Table 2-1	Configuration Table	2-1
Table 5-1	Apparent Faults	5-9

1. Overview

1.1 Overview

The "HSA4011 HIGH SPEED BIPOLAR AMPLIFIER" is a high-speed, wideband power amplifier with a frequency ranging from DC to 1 MHz and maximum output of 50 VA.

The frequency characteristic is almost flat in the range of DC to 1 MHz with little overshoot or sag of step response waveforms. Its ability to amplify from a direct current allows not only waveforms asymmetric between positive and negative polarities but also waveforms with a direct current superimposed to be transmitted correctly.

Implementing balanced output using two HSA4011s makes it possible to configure a high-speed, wideband power amplifier with a maximum output voltage of 300 Vp-p and maximum output of 100 VA.

The "HSA4000" series high-speed power amplifier/bipolar power supplies are available in the following models including the HSA4011:

HSA4101	DC to 10 MHz	50 Vrms	1 Arms	50 VA
HSA4011	DC to 1 MHz	50 Vrms	1 Arms	50 VA
HSA4012	DC to 1 MHz	50 Vrms	2 Arms	100 VA
HSA4014	DC to 1 MHz	50 Vrms	4 Arms	200 VA
HSA4051	DC to 500 kHz	100 Vrms	1 Arms	100 VA
HSA4052	DC to 500 kHz	100 Vrms	2 Arms	200 VA

1.2 Features

Wideband from DC to 1 MHz

Its ability to amplify from a direct current allows not only waveforms asymmetric between positive and negative polarities but also waveforms with a direct current superimposed to be transmitted correctly.

High output, high-speed

Output voltage: 150 V_{p-p} (DC to 100 kHz)

130 V_{p-p} (100 kHz to 1 MHz)

Through rate: 650 V/ μ s typ

Optimal waveform response

Overshoot, sag 5% or less

Variable gain:

$\times 10$ to $\times 300$ continuously variable

Input: 2-line input allows 2-line additions

Two inputs A and B, switching between input impedance of 50 Ω and 600 Ω

Allows addition of inputs A and B

Low output impedance

0.2 Ω + 1 μ H typ

DC addition capability

± 50 V 10-rotation potentiometer setting

High balanced output capability

Use of two HSA4011s provides 300 V_{p-p} and 100 VA.

Protection circuit with overload display

Input/output connector

BNC connector, installed on front and rear panels

1.3 Applications

Piezoelectric actuator impedance measurement

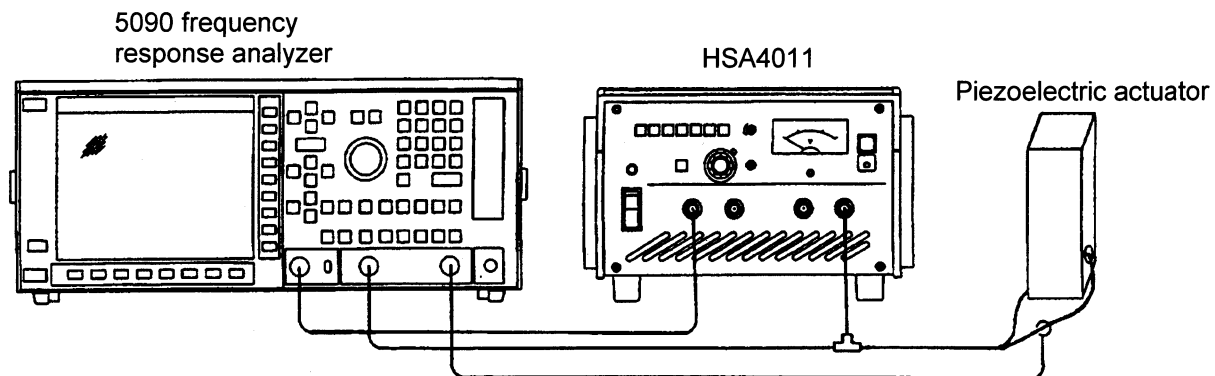

Ultrasonic motor drive

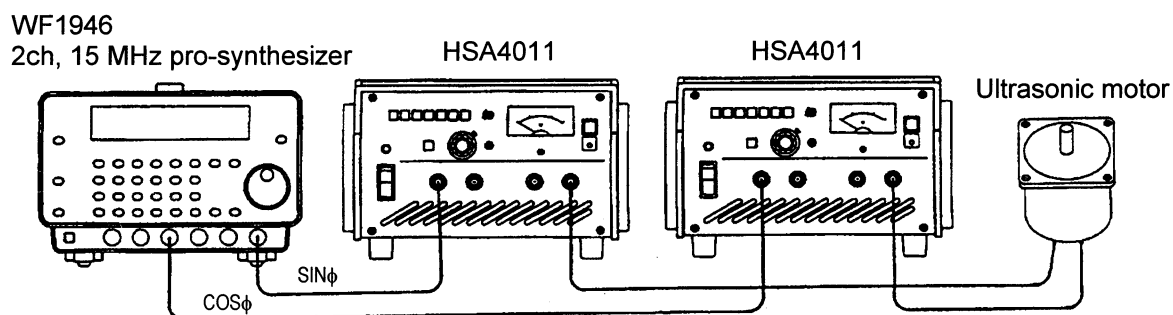

Amorphous magnetic substance test

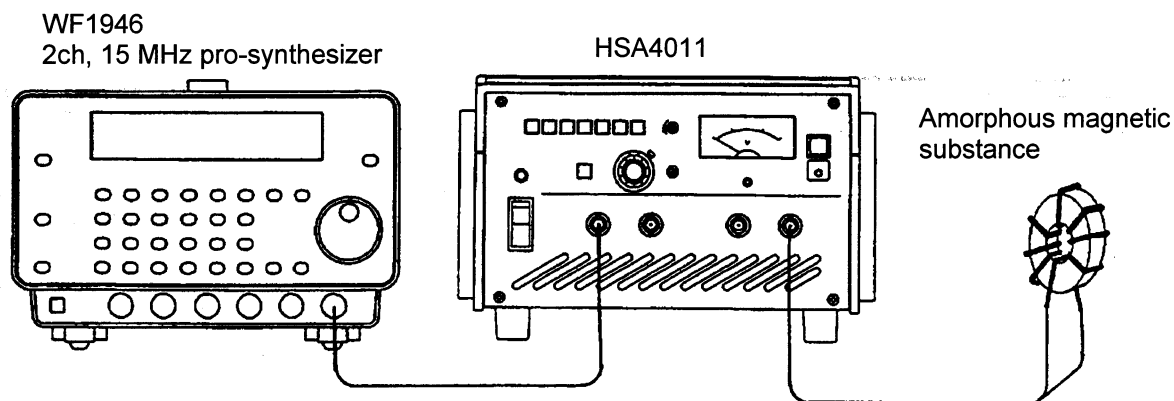

1.4 Function List

Capacitor ripple test

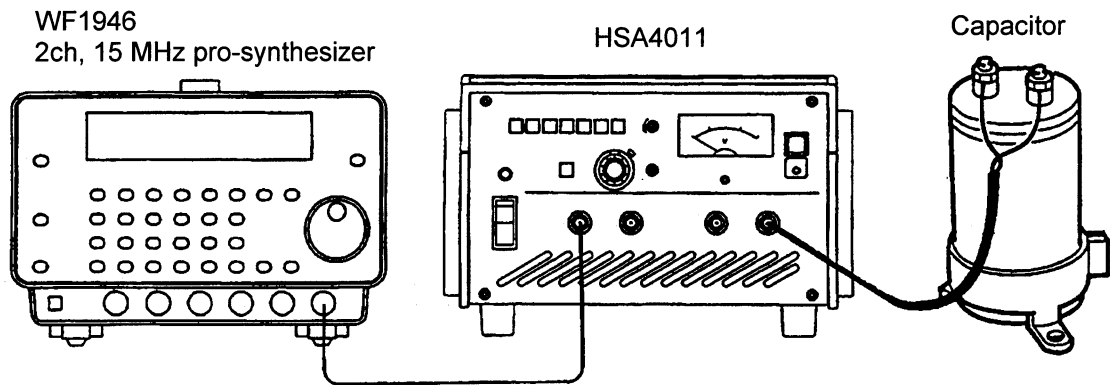

1.4 Function List

The HSA4011 has the following main functions:

Output: ON/OFF switching

Input: Input impedance switching: $50\Omega/600\Omega$

Input gain switching: Fixed $\times 10, \times 20, \times 50, \times 100$
or Continuously variable $\times 10$ to $\times 300$

Bias addition: ON/OFF setting

Continuously variable ± 50 V, 10 rotations

Offset fine adjustment: Continuously variable ± 0.5 V, 1 rotation

Display: Output meter: FS: 60 Vrms

Overload lamp

1.5 Principle of Operation

The HSA4011 consists of a preamp, power amp and power supply.

"Figure 1-1 Block Diagram" shows a block diagram of the HSA4011.

The preamp is a wideband operational amplifier. It has a two-input addition function, gain adjustment function, input impedance switching function and zero-point adjustment function.

The power amplifier is a wideband power amplifier using a high-speed FET for the output stage. Voltage gain is 15.6 times and has a bias superimposing function of ± 50 V and output voltage monitor function. The output is protected from overload by a current restriction type protection circuit.

The power supply uses a low-noise type series regulator circuit.

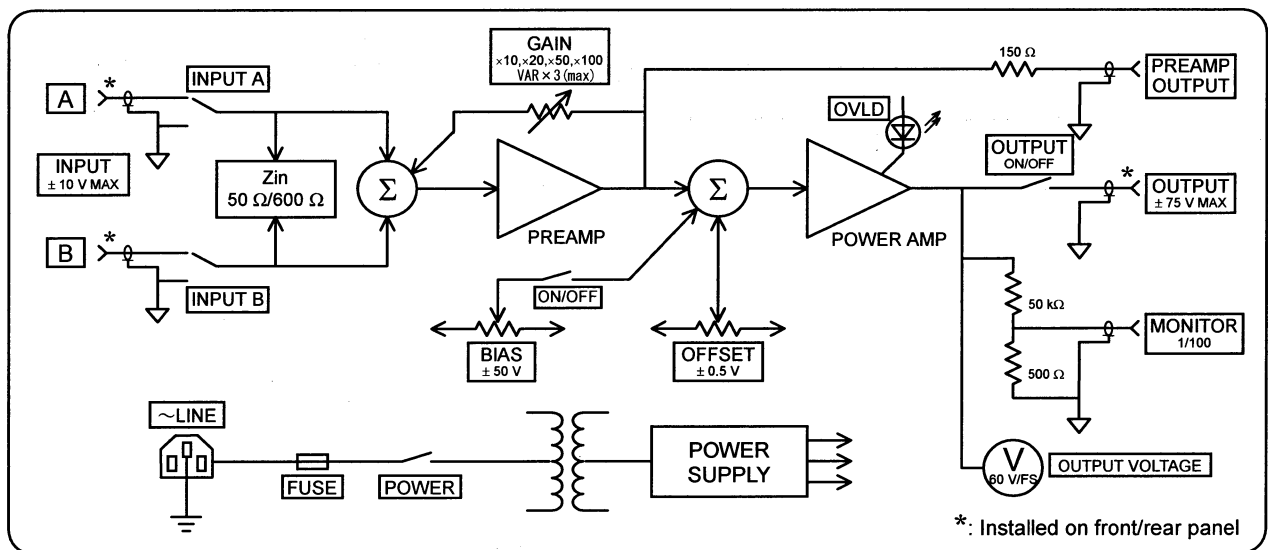

Figure 1-1 Block Diagram

2. Preparation

Before using the HSA4011, please read "Safety Precautions" again.

2.1 Appearance and Accessory Check

1. If there is any abnormality (damage or dent, etc.) in appearance of the cardboard box, immediately contact us or our sales agency.
2. Take the HSA4011 and accessories, etc. out of the cardboard box and check them. If any accessory is missing, contact us or our sales agency.
 - HSA4011 appearance check
Make sure there is no damage or dent on the panel surface, knobs and connectors, etc.
 - HSA4011 accessory check
Check that all accessories described in "Table 2-1 Configuration Table" are included.

2.2 Configuration

The HSA4011 has the following configuration. Check the number of pieces of each accessory.

Table 2-1 Configuration Table

HSA4011, main unit.....	1
Operation Manual	1
Accessories	
Power cord.....	1
Time lag fuse ($\phi 5.2 \times 20$ mm) 3.15 A.....	2
(One is incorporated in inlet)	
Signal cord (BNC - BNC 1 m).....	2

2.3 Assembly and Installation

Installation location

Do not place the HSA4011 on its back or side on the floor or a desk.
Place the HSA4011 in such a way that the four rubber legs at the bottom are supported on a level surface such as a desk.

Rack mount

The HSA4011 can be mounted on a standard millimeter or inch rack using auxiliary brackets.
Contact our sales representative specifying either millimeter or inch.

 **CAUTION**

For rack mount

- Use a rack mount with an effective mounting depth of 70 cm or more.
- Be sure to use a rail or shelf to support the HSA4011 so that it can resist shock and vibration.
- Provide upper and lower spaces of 5 cm or more to prevent an air flow from being blocked for the purpose of cooling inside the HSA4011. Furthermore, keep a space behind the rack, 30 cm or more apart from the wall to avoid convection of the exhaust air from the rear panel in the rack.

Installation condition

- The HSA4011 performs forced air cooling using a fan. Keep the front, rear and side where the air inlet and outlet are located away from the wall at least 30 cm to secure air circulation.

The allowable ranges of temperature and humidity are as follows:

During operation 0 to +40°C 20 to 90% RH

During storage -20 to +50°C 10 to 80% RH

However, keep the HSA4011 in an environment without condensation.

- Do not install HSA4011 in the following places:
 - Place exposed to inflammable gas
Danger of explosion. Do not install or use the HSA4011 in such a place under any circumstances.
 - Outdoors or place exposed to direct sun light or near fire or heat source
Can cause the HSA4011 to fail to satisfy performance or malfunction.
 - Place exposed to corrosive gas, water, dust, dirt or humid place
Can cause the HSA4011 to corrode or malfunction.
 - Place near electromagnetic field source or high-voltage equipment or power line
Can cause misoperation.
 - Place subject to vibration
Can cause misoperation or malfunction.

2.4 Power Supply and Grounding

The HSA4011 has the following power supply conditions:

Supply voltage: 90 to 110 VAC single-phase

Frequency range: 48 to 62 Hz

Power consumption: 250 VA or less

The supply voltage can be changed to 120 V, 200 V and 240 V as an option at the time of shipping from the factory.

The power supply input range for option 120 V, 200 V and 240 V is as follows:

120V 108 to 132V Single-phase

200V 180 to 220V Single-phase

240V 216 to 250V Single-phase

Connect the power cable according to the following procedure:

1. Turn off the power switch of the HSA4011.
2. Insert the provided power cord into the inlet on the rear of the HSA4011.
3. Insert the power cord plug into the 3-pole power receptacle.

Observe the power fuse rating

 **WARNING**

Danger of fire: When replacing the fuse, use one with the same rating.

The HSA4011 fuse is of a time lag type with a rating of 3.15 A/250 V for a supply voltage of 100/120 V and 2 A for a supply voltage of 200/220 V ($\phi 5.2 \times 20$ mm).

When replacing the fuse, be sure to remove the power cord from the receptacle.

2.4 Power Supply and Grounding

The rated current of the HSA4011 fuse is 3.15 A for a supply voltage of 100/120 V and 2 A for a supply voltage of 200/240 V.

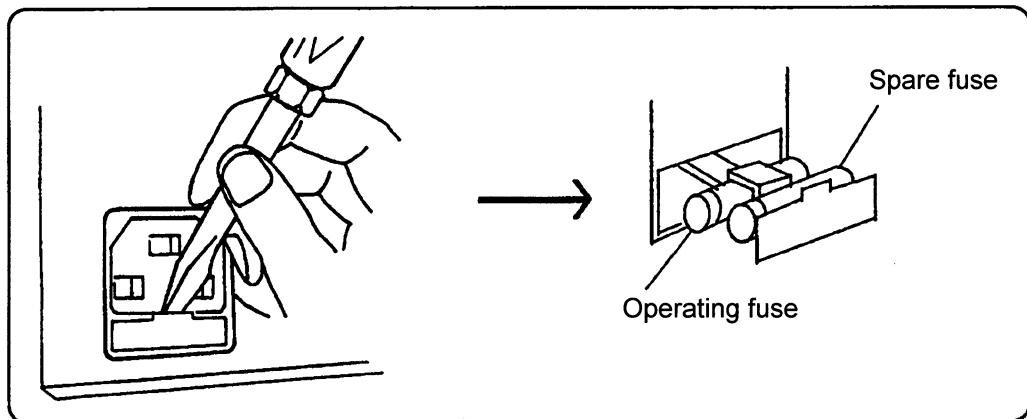

Figure 2-1 Replacement of Fuse

Be sure to ground

CAUTION

The HSA4011 is isolated from the primary side of the power source in the internal power transformer. However, make sure to ground the HSA4011 for safety.

Be sure to properly connect the ground. By connecting the 3 conductor power cable to a grounded 3-terminal wall socket, HSA4011 is automatically grounded.

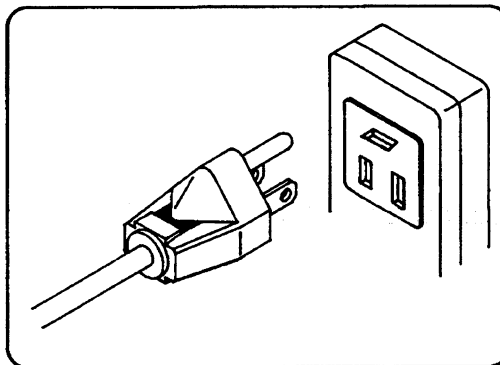

Figure 2-2 Connection of Power Supply Connector

2.5 Simple Operation Check

This section describes a simple receiving check when you purchase the product and an operation check after storage for an extended period of time.

WARNING

Do not remove the outer cover of the HSA4011.

No persons other than trained service technicians who are familiar with danger should check the interior of the product.

Connection

According to "Figure 2-3 Standard Connection Diagram", connect a signal generator, voltmeter and oscilloscope.

Panel setting

Set the panel knob and push button as follows:

Input setting: A, 600 Ω ; gain setting: $\times 100$ CAL; bias: OFF; dial 5.00

Operation

1. Turn on the power. After the overload lamp turns on transiently, the power lamp turns on, the output ON lamp turns off and the overload lamp turns off. Check that the level meter points to 0 V.
2. Check that when the frequency of the signal generator is set to 1 kHz, sine wave and the level is gradually increased from 0 V to 0.5 Vrms at input A, the reading of the level meter changes from 0 V to 50 Vrms.
3. Press the output ON switch and check with the oscilloscope and voltmeter that approximately 50 Vrms is output from the output connector. At this time, check that no distortion such as clip is generated on a waveform.
4. Check that when the gain range is set to $\times 50$, $\times 20$ and $\times 10$, the output level becomes 25 V, 10 V and 5 V, respectively.
5. Set the level of the oscillator to 0 V, turn on the bias and adjust the bias dial, then check the reading of the level meter and output voltage.

Scale	0.00	2.00	5.00	8.00	10.00
Output	-50 V	-30 V	0	+30 V	+50 V
Reading of meter	50 V	30 V	0	30 V	50 V

2.6 Calibration

Necessary measurement instruments

The following measurement instruments are necessary for an operation check:

Signal generator: Frequency/1 kHz; waveform/sine wave; output voltage/0.5 V or more; manufactured by NF CORPORATION, WF1946, 2ch 15 MHz synthesizer, etc.

Oscilloscope: Frequency band/20 MHz or more, 100 V or more using a 10:1 probe

Voltmeter: AC and DC voltage measurement/range of 100 V or more

Since a load test is not performed, no load (terminator) resistor is required.

⚠ WARNING

When smoke is produced from the equipment or you feel abnormal smell or abnormal sound, immediately unplug the power cord from the receptacle and do not use the product until it is completely repaired.

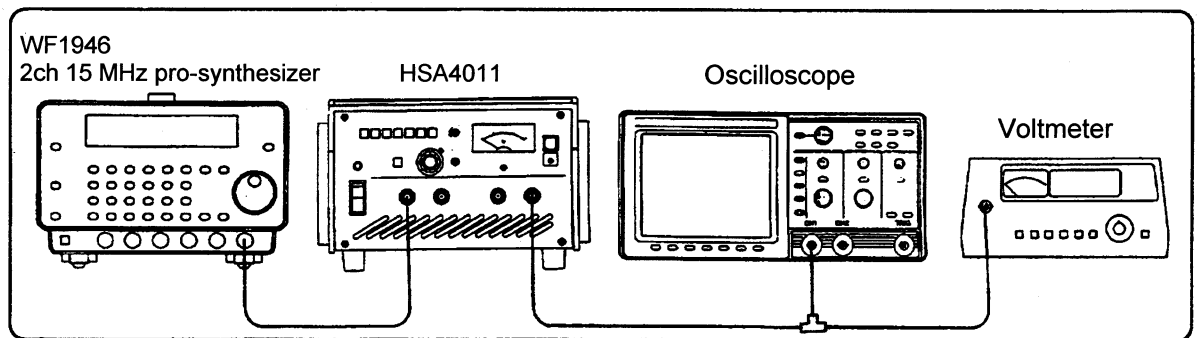

Figure 2-3 Standard Connection Diagram

2.6 Calibration

Perform "5.4 Performance Test" on the HSA4011 at least once a year. If the HSA4011 is used frequently and/or under an severe operating environment, it is necessary to perform the test more frequently.

Moreover, when conducting an important measurement or when the product is used for testing, it is recommended to carry out a performance test immediately before use. Performance tests should be conducted by persons who have general knowledge of measuring instruments.

3. Description of Panel and Basic Operations

3.1 Names and Operations of Panel Components

Front panel

Power display lamp

This lamp turns ON when the HSA4011 is operating.

Power switch

Turns ON power. When the cooling fan stops, this switch automatically turns OFF.

Input signal changeover switch

Pressing both A and B adds up both signals.

Input impedance switching

Switches between $50\Omega/600\Omega$.

Gain switch/fine adjuster

Variable from $\times 10$ to $\times 300$ by changing gain combinations

BIAS switch dial

When ON, allows a bias voltage of DC voltage ± 50 V to be added.

Offset fine adjuster

Can adjust a DC offset of output to 0 V.

Level meter

Displays output voltage.

Output ON/OFF

Turns ON/OFF output.

A lamp turns ON when output is ON.

Overload lamp

This lamp turns ON when the HSA4011 is overloaded and output current is restricted.

Input connectors A and B

Signal input connectors

Connected in parallel with the input connector on the rear.

Use either one.

3.1 Names and Operations of Panel Components

Monitor output

Outputs a voltage of 1/100 of main output.

Main output connector

This is the main output of the HSA4011. Produces a maximum of 50 Vrms, ± 75 Vdc. It is connected in parallel with the main output connector on the rear. Use either one whenever possible.

Rear panel

Input connectors A and B

Signal input connectors

Connected in parallel with the input connector on the front.

Preamplifier output

Outputs a voltage approximately 1/15 of main output.

Main output connector

This is the main output of the HSA4011. It is connected in parallel with the main output connector on the front.

Power input fuse

Has a dual function as an inlet and fuse holder.

Use a fuse of a specified value.

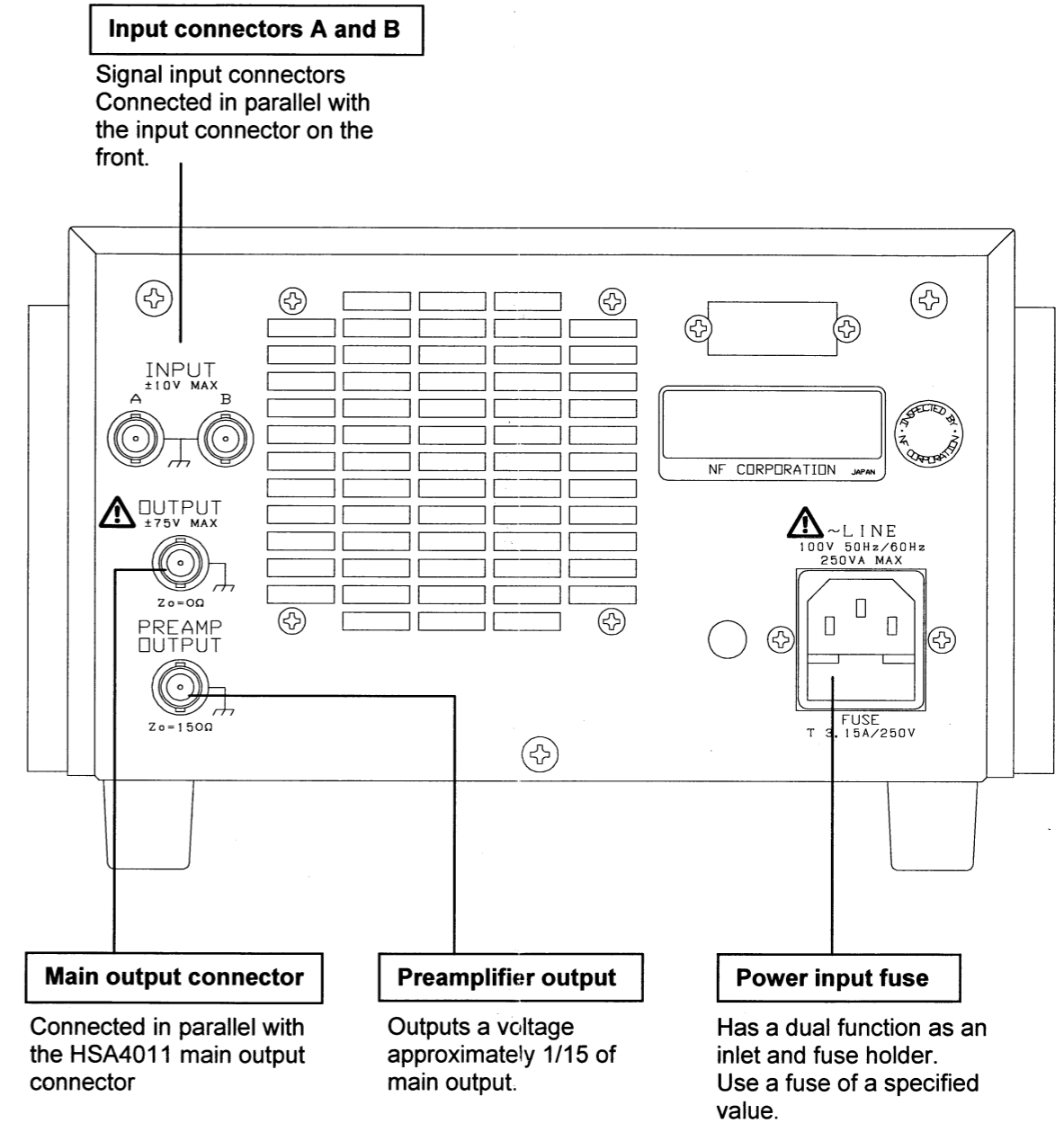
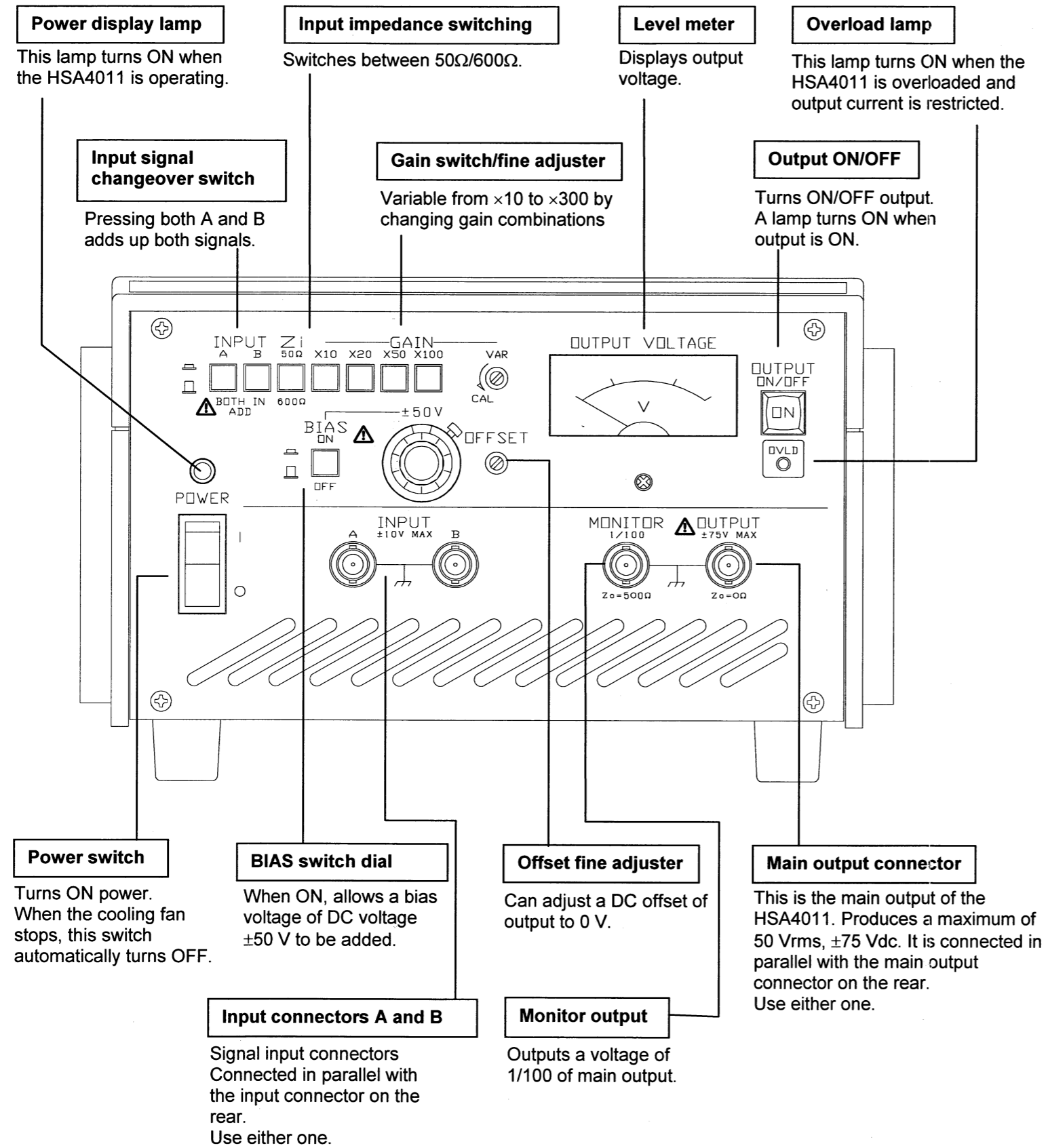

Figure 3-1 Front/Rear View of Panel

3.2 Display on Power Up and Initial Setting

3.2 Display on Power Up and Initial Setting

When power is turned on for the first time, perform the following initial setting:

Input selection: A; input impedance: 600Ω; gain: ×10 CAL; bias: OFF; dial: 5.00

When power is turned on, the power lamp turns ON, the output ON lamp turns OFF, the overload lamp turns OFF and the level meter points to 0 V.

3.3 Input/Output Terminals

Input BNC connector A/B front/rear

This is a signal input connector. The connectors on the front and rear are connected in parallel. Use either one. Select input signal changeover switch A/B input. Pressing both A and B adds up both signals.

Input connector: BNC-R (1 for front and 1 for rear for both A and B)

Input impedance: Select 600Ω or 50Ω

Maximum allowable voltage: ±10 V



Adding a voltage exceeding the allowable input voltage may damage the equipment. Be careful not to exceed the allowable input voltage range.

Main output

This is an output connector. The connectors on the front and rear are connected in parallel. When using both connectors, be careful to ensure that the total output does not exceed maximum power. When using the product at a high frequency of 100 kHz or more, use only one of the connectors on the front and rear.

Output connector: BNC-R (1 for front and 1 for rear)

Maximum output voltage: 50 Vrms or more, 40 Hz to 500 kHz, 50Ω load

45 Vrms or more, 20 Hz to 1 MHz, 50Ω load

±75 V or more, DC to 100 kHz, 100Ω load

±70 V or more, DC to 500 kHz, 100Ω load

±65 V or more, DC to 1 MHz, 100Ω load

Maximum output current: 1 Arms (2.88 Ap-p) or more, 40 Hz to 1 MHz

±0.75 A or more, DC to 40 Hz

Output impedance: 0.2Ω + 1μH typ

⚠ WARNING

The maximum voltage of the HSA4011 is ± 75 V or more. Touching the HOT side of the output may cause electric shock. Observe the following precautions for safe use:

- Turn OFF power when conducting wiring.
- When power is ON, do not touch the HOT side of the output. Do not touch it when your body is wet in particular.

Monitor output

The HSA4011 is provided with a monitor output connector to observe the output voltage and allows you to observe an output waveform by directly connecting an oscilloscope to it. Monitor output is also output when the output is OFF. A voltage equivalent to 1/100 of the main output is output.

Output connector: BNC-R (front)

Output voltage: 1/100 of main output (in-phase with respect to input)

Output impedance: 500Ω

⚠ CAUTION

The monitor output is derived from the main output by dividing it through resistors. Thus, note that it may include a certain error caused by input impedance of devices connected.

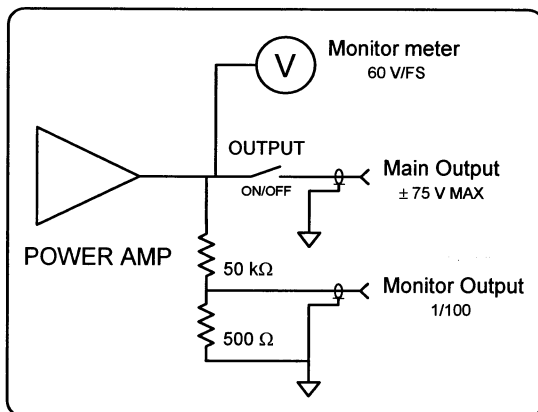

Figure 3-2 Main Output & Monitor Output

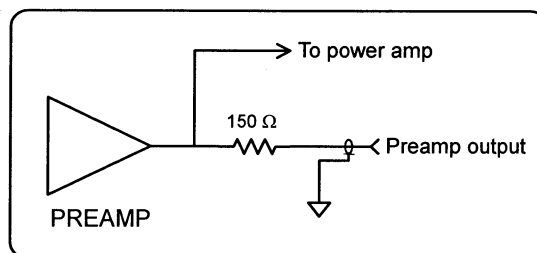

Figure 3-3 Preamp Output

3.4 Input/Output Connection

Preamp output

This is a preamp output. Used for connection of balanced output using two HSA4011s. A voltage equivalent to approximately 1/15 of the main output is output.

☛ For balanced output, see "4.2 Increase of Output Using Balanced Output."

Output connector: BNC-R (rear)

Output voltage: 1/15.6 of main output (inverse phase with respect to input)

Output impedance: 150Ω

3.4 Input/Output Connection

A connection diagram is shown in "Figure 3-4 Basic Connection Diagram." To exploit full performance of the HSA4011, the following points should be noted on the WF1946, 2ch 15 MHz pro-synthesizer, connection cord and load.

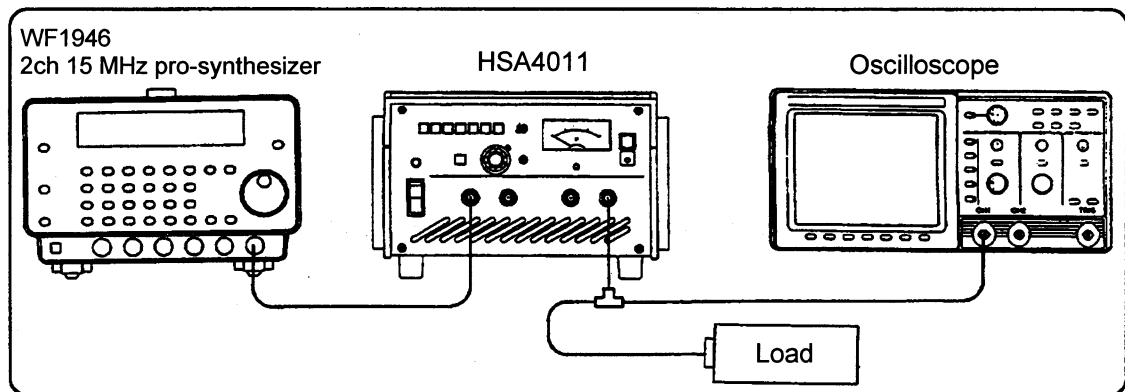

Figure 3-4 Basic Connection Diagram

Signal generator

Use a signal generator that generates waveforms with correct frequencies and large output capacity of 2 to 5 Vrms whenever possible.

When using a high frequency of 100 kHz or more; use a signal generator with output impedance of 50Ω and set the input impedance of the HSA4011 to 50Ω.

Signal cord

Use the provided BNC cable as the input cord.

For the output cord, also attach a BNC connector near the load and use the provided BNC cable.

Load

Attach a BNC connector near the load and use the provided BNC cable.

Place the load near the HSA4011 whenever possible and use it within the range of the length of the provided cable.

3.5 Basic Operation Example

Selection of input selection/input impedance

Connect either one of input connectors A and B with the output of the signal generator using the provided signal cord.

Push the input signal changeover switch A or B to which the input connector is connected to select input impedance 50Ω or 600Ω.

CAUTION

1. Use input connectors A and B either on the front or rear. If the signal generators are connected to both sides, the signal generators themselves are connected, which may damage the signal generators.
2. Applying a voltage exceeding the allowable input voltage may damage the equipment. Be careful not to exceed the allowable input voltage range ± 10 V.

When a waveform that adds up two signals is necessary, connect the signal generators to both input connectors A and B and push in both input signal changeover switches A and B. To change the addition ratio, change the level using the signal generator connected.

Adjustment of output voltage

The gain can be set within the range of $\times 10$ to $\times 300$ using gain switch of $\times 10$, $\times 20$, $\times 50$ and $\times 100$ and fine adjuster.

To obtain a maximum output voltage of 50 Vrms, the signal generator must have an output voltage of 0.167 V/50Ω to 600Ω (gain $\times 300$) to 5 V/50Ω to 600Ω (gain $\times 10$).

Use a signal generator providing a high output of 2 to 5 Vrms wherever possible.

Fine adjustment of output offset

In the case of a problem that occurs if a DC component is superimposed on a signal such as inductance, it is possible to perform fine adjustment that sets the offset voltage included in the output signal of the HSA4011 to zero. Perform fine adjustment of the offset voltage according to the following procedure.

A DC offset changes to a certain degree by the gain setting range. First, adjust the output gain. Then, remove the input cord. Select A or B as the input. Set input impedance to 50Ω. Connect the DC voltmeter (digital voltmeter, etc.) to the output and adjust the DC output voltage to zero using pre-set variable resistor for offset fine adjustment.

This offset fine adjustment is performed with the output ON/OFF switch set to ON.

The product can be used more stably if offset fine adjustment is performed 30 minutes to 1 hour after initial drifts are completed after power is turned on.

After fine adjustment of output offset is completed, connect the removed input cord between the input connector (A or B according to the selected signal) and the output of the signal generator.

3.5 Basic Operation Example

Addition of DC bias

The HSA4011 can output the output voltage signal with a DC voltage added. Turn ON the bias switch and perform setting using the bias dial. The range of the bias voltage is ± 50 V. If the input is zero, the voltage added can be monitored by the level meter.

The relationship between the dial memory and output bias voltage can be calculated as follows:

$$\text{Bias output voltage} = (\text{set scale} - 5.00) \times 10 \text{ Vdc}$$

 **CAUTION**

If the maximum output voltage exceeds ± 75 V, the output waveform is clipped and the overload lamp turns ON. When adding the DC bias, be careful not to allow the waveform to be clipped.

Monitoring output voltage

The HSA4011 is provided with a monitor output and a monitor meter for monitoring the output voltage.

The monitor output connector allows an output waveform to be observed by directly connecting an oscilloscope and the output waveform is output irrespective of output ON/OFF. As the output voltage, a voltage equivalent to 1/100 of the main output is output.

The monitor output is derived from the main output by dividing it through resistors and output. Therefore, the monitor output decreases because it is influenced by input impedance (load resistance) of the device connected.

The influence of the load is calculated as follows:

$$\text{Monitor output} \times \left(1 - \frac{500\Omega}{500\Omega + \text{load resistance } (\Omega)}\right)$$

The monitor meter follows the double wave rectification average detection system and indicates the result in sine wave effective values. In the case of DC, values are shown in absolute values, and so the same value is shown without polarity "+" or "-".

Furthermore, if AC is superimposed on DC, an average value is shown. For example, if a 5 Vrms sine wave is superimposed on a +10 V DC, 10 V is indicated and a 5 Vrms sine wave with zero DC component is indicated as 5 V.

Output ON/OFF control

The main output signal can be turned ON/OFF. ON/OFF is changed through a relay contact.

 **CAUTION**

Note that if a load containing an inductance component is connected, turning OFF the output may generate a high voltage.

4. Applications

4.1 Maximum Output Current and Operation Area

The HSA4011 is provided with an output current restriction protection circuit that detects and restricts an output current and the maximum output current is determined by this protection circuit. This restriction value varies depending on the frequency and output voltage. This relation is shown in "Figure 4-1 Operation Area."

The graph shows an AC (frequency 40 Hz or more) peak value area and a DC (frequency 1 Hz or less) and AC average value areas. In the frequency range of 1 to 40 Hz, the current is protected with an intermediate value.

In general, if the load when an AC signal is used is resistance, the 1st quadrant and 3rd quadrant are the operation area and if the load is capacitive or inductive, all quadrants become the operation area.

Furthermore, if the load has an electromotive force even when a DC signal is used and power is poured from the load, the 2nd quadrant and 4th quadrant become the operation area. An electronic-load-like operation corresponds to this case.

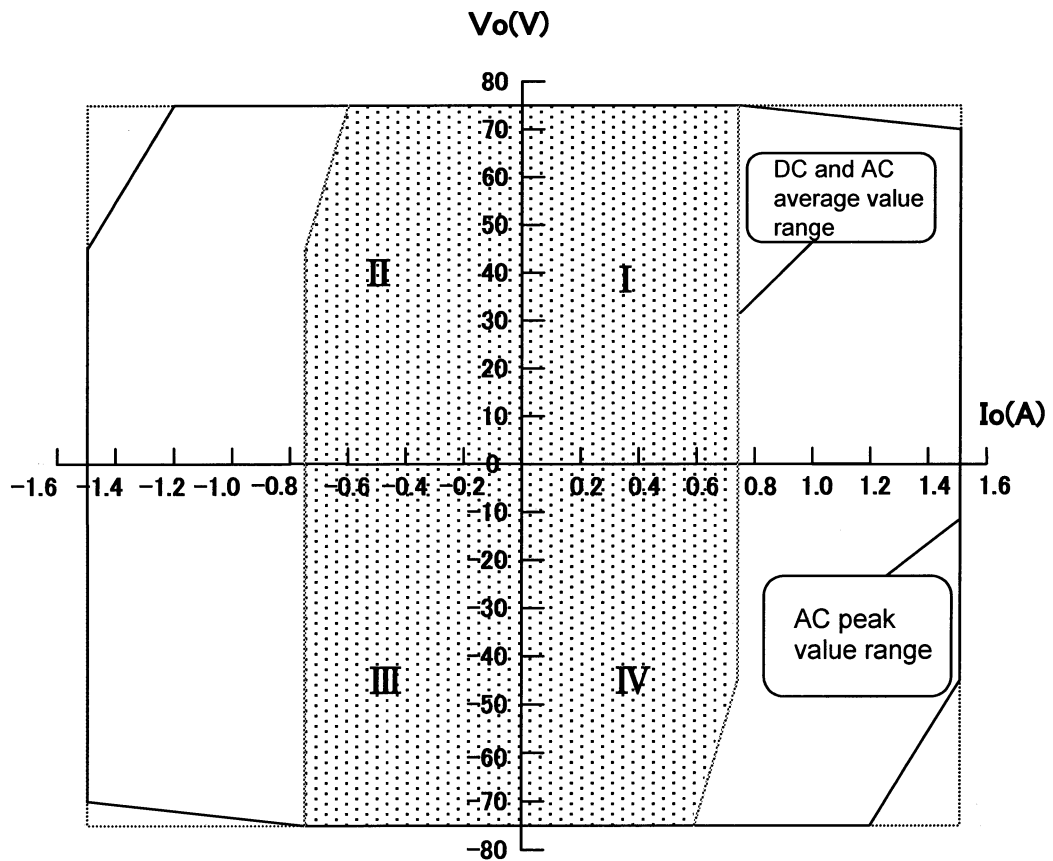

Figure 4-1 Operation Area

4.1 Maximum Output Current and Operation Area

The operation area when a signal waveform is asymmetric between positive and negative polarities and a direct current is generated will be explained. In the case of a waveform like "Figure 4-2 Current Waveform Asymmetric between Positive and Negative Polarities", consider positive and negative polarities of the waveform separately as an average value (+Iave), peak value (+Ip) on the positive side and an average value (-Iave) and peak value (-Ip) on the negative side.

The average values (+Iave, -Iave) and peak values (+Ip, -Ip) are each restricted by the DC operation restriction area and AC peak operation restriction area.

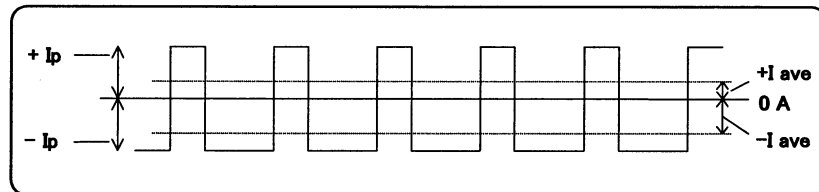

Figure 4-2 Current Waveform Asymmetric between Positive and Negative Polarities

4.2 Increase of Output by Balanced Output

When balanced output connection is implemented using two HSA4011s, it is possible to double the output voltage and output power (the output current remains the same as with one HSA4011). The connection is realized by connecting the preamp output of the master device to the input connector (A or B) of the slave device as shown in "Figure 4-3 Connection of Balanced Output" and setting input impedance to 600Ω . Set the gain of the slave device to $\times 10$, adjust the pre-set variable resistor so that the master device and slave device have the same output voltage (the phase is reversed).

The overall gain is determined by the gain setting of the master device.

Connect the load between the master device and slave device as shown in "Figure 4-3 Connection of Balanced Output." At this time, it is not possible to connect one of the load terminals commonly to the chassis of the HSA4011 and signal generator. Therefore, when used for this connection, the load must be insulated from the grounding potential and signal source.

CAUTION

Insulate the load from the grounding potential and signal source.

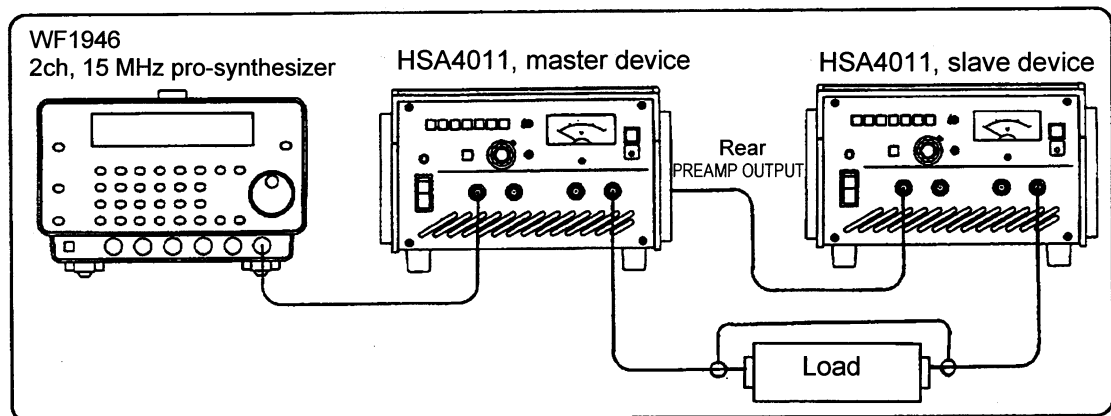

Figure 4-3 Connection of Balanced Output

5. Maintenance

5.1 Introduction

This section describes the following:

- Cautions and storage method when product is not used for extended period of time
 - Cautions for repacking and transportation
 - Performance tests necessary for receiving inspection for preventive maintenance and performance check after repair
 - Symptoms and action for apparent fault
- ☞ For a simple operation check, see "2.5 Simple Operation Check."

When the product does not pass an operation check or performance test or malfunctions, ask us or our sales agency for calibration or repair.

5.2 Daily Care

When panel or case is dirty

When the panel or case is dirty, wipe it using a soft cloth. If the panel or case is extremely dirty, wipe it with a cloth soaked in a detergent. Using an organic solvent such as thinner and benzene or chemical cloth may alter the quality or damage the paint rendering characters illegible.

5.3 Storage, Repacking and Transport

Storage in case of non-use for extended period of time

- Remove the power cord from the receptacle and HSA4011.
- Store the product in a shelf or rack, etc. places where there is no falling object or dust. If the product is possibly subject to dust, put a cloth or polyethylene cover.
- The environmental condition for storage is -20°C to 50°C , 10% to 80% RH, but avoid places with drastic temperature variations or exposed to direct sunlight and store in an environment at ordinary temperatures.

Repacking and transport

When repacking the product for transport or asking for repair, consider the weight of the HSA4011 and note the following points.

- Put the HSA4011 in a polyethylene bag or wrap it with a sheet.
- Prepare a cardboard box which will withstand the weight of the HSA4011 and provide a sufficient space.
- Put a cushioning material to protect the six sides of the HSA4011 and pack it. Ideally, use the cardboard box and stuffing materials provided at the delivery.
- When asking for transport, inform the transport company that this product is a precision instrument.

5.4 Performance Test

- A performance test is conducted to prevent deterioration of the performance of the HSA4011 or as part of preventive maintenance. It is also conducted when a receiving inspection, periodic inspection or a performance check after repair is required. If the performance test result shows that the product does not meet the specification, calibration or repair is required.

⚠ WARNING

Do not remove the outer cover of the HSA4011.

Inspections of the interior of the product should not be performed by any persons other than trained service technicians who are familiar with danger.

- The measuring instruments used for performance tests are as follows:

Measuring instrument	Main performance	Recommended product
Signal generator	0.01 Hz to 10 MHz Sine wave, square wave, 20 Vp-p	WF1946 manufactured by NF CORPORATION
Low distortion signal generator	10 Hz to 1 MHz low distortion	E-1205 manufactured by NF CORPORATION
AC voltmeter	10 Hz to 10 MHz, 1mV to 100V	8920A manufactured by Fluke Corporation
Digital voltmeter	0 to ±100V	
Frequency response analyzer	10 Hz to 1 MHz	5090 manufactured by NF CORPORATION
Oscilloscope	DC to 50 MHz, 10mV to 100V	
Distortion meter	10 Hz to 600 kHz	DM-153B manufactured by NF CORPORATION
Terminator	50Ω ±1%/50W 10Ω ±5%/22W	

- Before starting performance tests, perform fine adjustment of the offset voltage of the HSA4011 to zero and check the following items:
 - ☞ **For the fine adjustment method, see "3.5 Basic Operation Example Output Offset Fine Adjustment."**
 - Is the supply voltage within the proper range?
 - Are the ambient temperature and ambient humidity within the range of 15°C to 35°C, 25% to 75% RH?
 - Is there condensation?
 - Have 30 minutes or more elapsed after power is turned on?

5.4.1 Measuring Maximum Output Voltage

Connection

Connect the signal generator, AC voltmeter, oscilloscope and terminator of 50Ω as shown in "Figure 5-1 Maximum Output Check."

Setting

Set the HSA4011 as follows:

- Input changeover: "A"; input impedance: " 50Ω "; gain setting: " $\times 20$ ";
- gain fine adjustment: "CAL"; bias addition: "OFF/dial 5.00"

Test procedure

Select a sine wave as the waveform of the signal generator, adjust the frequency to a check frequency and turn ON the output ON/OFF switch of the HSA4011. Gradually increase the output voltage of the signal generator from 0 V. Observe the waveform using an oscilloscope and record the output voltage when the waveform starts to clip (or distortion increases).

Judgment

The product passes the test if it satisfies the judgment criteria at 20 Hz, 500 Hz and 1 MHz.

Setting frequency	Judgment criteria	Measured value	Judgment
20 Hz	50 Vrms or more	---	Acceptable/rejected
500 kHz	50 Vrms or more	---	Acceptable/rejected
1 MHz	40 Vrms or more	---	Acceptable/rejected

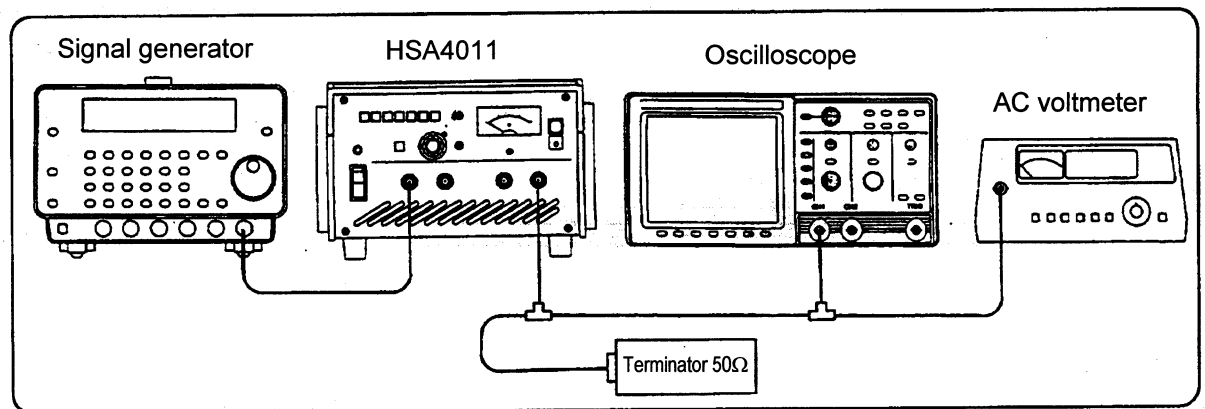

Figure 5-1 Maximum Output Check

5.4.2 Measuring Maximum Output Current

Connection

Connect the signal generator, AC voltmeter, oscilloscope and terminator of 10Ω as shown in "Figure 5-2 Maximum Output Current Check."

Setting

Set the HSA4011 as follows:

- Input changeover: "A"; input impedance: "600Ω"; gain setting: "×20";
- gain fine adjustment: "CAL"; bias addition: "OFF/dial 5.00"

Test procedure

Select a sine wave as the waveform of the signal generator, adjust the frequency to 400 Hz and turn ON the output ON/OFF switch of the HSA4011. Gradually increase the output voltage of the signal generator from 0 V. Observe the waveform using an oscilloscope and record the output voltage when the waveform starts to clip.

Judgment

The product passes the test if the voltage at which clipping starts is 10.6 Vrms or more.

Setting frequency	Judgment criteria	Measured value	Judgment
400 Hz	10.6 Vrms or more	---	Acceptable/rejected

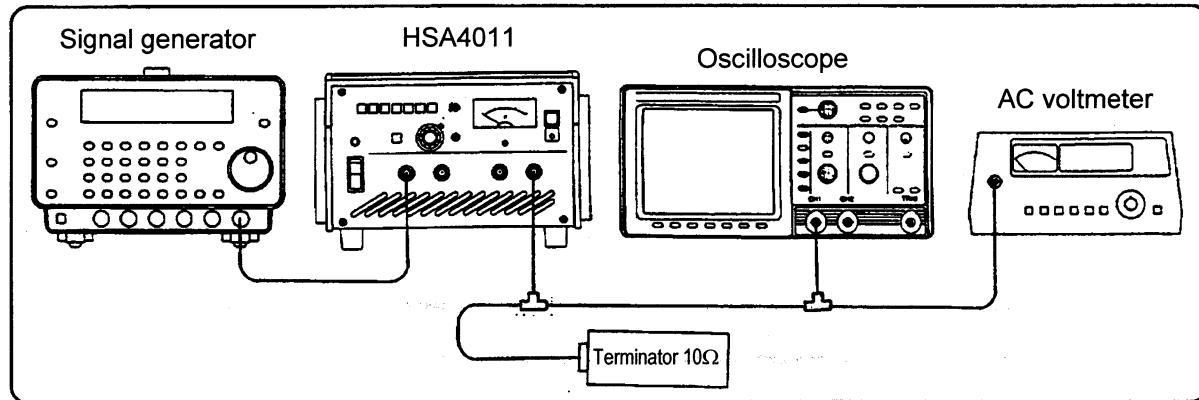

Figure 5-2 Maximum Output Current Check

5.4.3 Measuring Frequency Characteristic

Connection

Connect the 5090 frequency response analyzer (hereafter abbreviated as "FRA") and terminator of 50Ω as shown in "Figure 5-3 Measuring Frequency Characteristic."

Setting

Set the HSA4011 as follows:

- Input changeover: "A"; input impedance: " 600Ω "; gain setting: " $\times 20$ ";
- gain fine adjustment: "CAL"; bias addition: "OFF/dial 5.00"

Set the FRA as follows:

- Output: sine wave 1.53 V_{peak}; sweep frequency: 100 Hz to 1 MHz; log sweep;
- analysis: ch1/ch2; display: logF-logR- θ

Test procedure

Turn ON the FRA output and let it perform UP (or DOWN) sweeps and measure from 100 Hz to 1 MHz. After the measurement, move the cursor and read the gain at 400 Hz, 100 kHz, 500 kHz and 1 MHz.

Judgment

The product passes the test if it meets the judgment criteria at 100 kHz, 500 kHz and 1 MHz relative to 400 Hz (assumed to be 0 dB).

Setting frequency	Judgment criteria	Measured value	Judgment
400 Hz	0 dB (reference)	0.00	Set this as reference
100 kHz	-0.3 to +0.3 dB	---.---	Acceptable/rejected
500 kHz	-0.5 to +0.5 dB	---.---	Acceptable/rejected
1 MHz	-1.0 to +0.5 dB	---.---	Acceptable/rejected

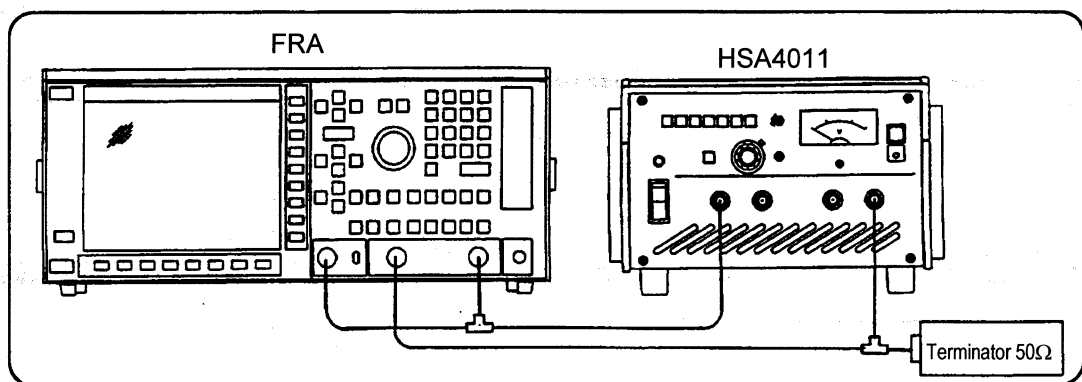

Figure 5-3 Measuring Frequency Characteristic

5.4.4 Measuring Gain Error

Connection

Connect the FRA and terminator of 50Ω as shown in "Figure 5-3 Measuring Frequency Characteristic."

Setting

Set the HSA4011 as follows:

Input changeover: "A"; input impedance: "600 Ω "; bias addition: "OFF/dial 5.00"

Set the FRA as follows:

Output: sine wave; frequency: 400 Hz; analysis: ch1/ch2; display: logF-logR- θ

Test procedure

Set the gain of the HSA4011 and output voltage of the FRA as follows and turn ON the output of the FRA and carry out measurement in continuous mode. (Measure with output of almost 40 Vrms.)

Judgment

The product passes the test if it meets the judgment criteria at gain $\times 10\text{CAL}$, $\times 20\text{CAL}$, $\times 50\text{CAL}$, $\times 100\text{CAL}$ and $\times 100\text{UNCAL}$ maximum.

Set gain	FRA output voltage	Judgment criteria	Measured value	Judgment
$\times 10\text{CAL}$	6.1 Vpeak	9.5 to 10.5	___ . ___	Acceptable/rejected
$\times 20\text{CAL}$	3.0 Vpeak	19.0 to 21.0	___ . ___	Acceptable/rejected
$\times 50\text{CAL}$	1.2 Vpeak	47.5 to 52.5	___ . ___	Acceptable/rejected
$\times 100\text{CAL}$	0.6 Vpeak	95 to 105	___ . ___	Acceptable/rejected
$\times 100\text{UNCAL}$	0.2 Vpeak	300 or more	___ . ___	Acceptable/rejected

5.4.5 Measuring Sine Wave Distortion Rate

Connection

Connect the low distortion oscillator, distortion meter, oscilloscope and terminator of 50Ω as shown in "Figure 5-4 Measuring Sine Wave Distortion Rate."

Setting

Set the HSA4011 as follows:

Input changeover: "A"; gain $\times 20\text{CAL}$; input impedance: " 600Ω "; bias addition: "OFF/dial 5.00"

Test procedure

Adjust the output level of the low distortion oscillator so that the output voltage of the HSA4011 becomes 40 Vrms. Measure the sine wave distortion rate at frequencies 40 Hz, 1 kHz, 100 kHz and 500 kHz.

Judgment

The product passes the test if it meets the judgment criteria at different frequencies.

Setting frequency	Judgment criteria	Measured value	Judgment
40 Hz	0 to 0.1%	0. ___	Acceptable/rejected
1 kHz	0 to 0.1%	0. ___	Acceptable/rejected
100 kHz	0 to 0.5%	0. ___	Acceptable/rejected
500 kHz	0 to 3.0%	_. ___	Acceptable/rejected

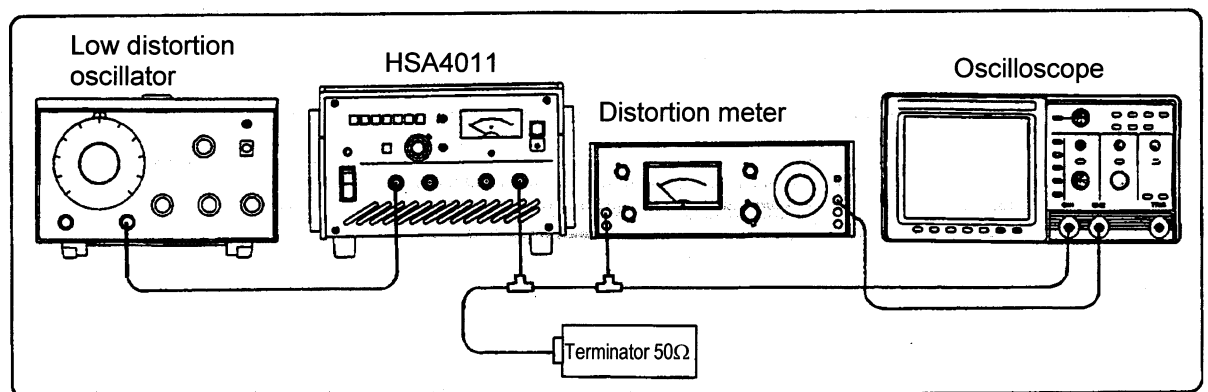

Figure 5-4 Measuring Sine Wave Distortion Rate

5.4.6 Measuring Bias Addition Voltage

Connection

Connect the digital voltmeter and terminator of 50Ω as shown in "Figure 5-5 Measuring Bias Addition Voltage."

Setting

Set the HSA4011 as follows:

- Input changeover: "A"; gain ×20CAL; input impedance: "600Ω"

Test procedure

Before testing, perform fine adjustment of the offset voltage of the HSA4011 to zero with special care. Turn ON bias addition of the HSA4011 and gradually change the dial from 5.00 and measure the output voltage when the scale is set to 0.00, 2.00, 5.00, 8.00 and 10.00.

After the measurement is completed, set bias addition "OFF/dial 5.00" for safety.

Judgment

The product passes the test if it meets the judgment criteria at different frequencies.

Dial setting	Judgment criteria	Measured value	Judgment
0.00	-53.0 to -49.0	---	Acceptable/rejected
2.00	-32.2 to -29.0	---	Acceptable/rejected
5.00	-1.0 to +1.0	---	Acceptable/rejected
8.00	+29.0 to +32.2	---	Acceptable/rejected
10.00	+49.0 to +53.0	---	Acceptable/rejected

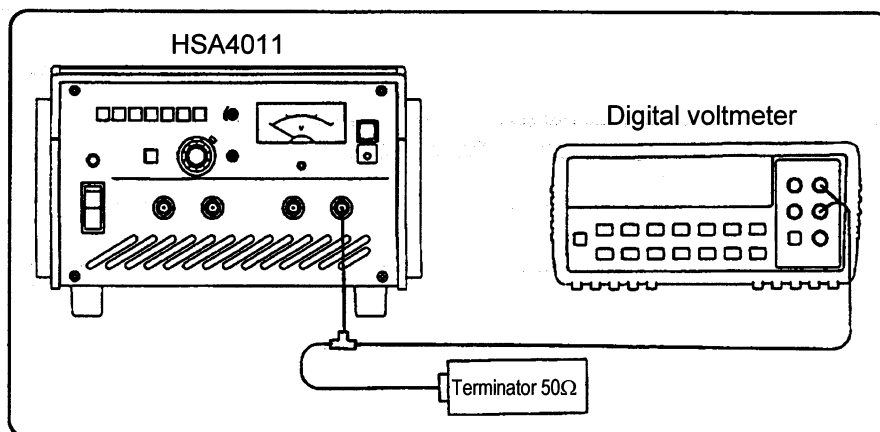

Figure 5-5 Measuring Bias Addition Voltage

5.5 Handling Apparent Faults

The product may be suspected to be malfunctioning if the following phenomena occur. Take the "necessary action." If the product is not recovered from these phenomena, contact us or our sales agency.

Table 5-1 Apparent Faults

Phenomenon	Possible cause	Necessary action
No operation on power up	Fuse is blown out.	Replace the fuse with a normal one.
	Power line is not connected.	Securely insert the power cord into the plug.
No output	Signal is not connected. Input is not selected.	Connect the signal generator and securely push the input selection push button switch.
	Output ON/OFF switch is not turned ON.	Turn ON the output ON/OFF switch.
Overload lamp turns ON	Overload?	Remove the load and if the overload lamp turns OFF, connect a load within the range of maximum output.
	Signal level of signal generator is excessive.	Reduce the level of the signal generator connected.
	Is gain setting correct?	Set the gain setting switch to an appropriate range.
DC appears on output	Bias addition switch is ON.	Turn OFF the bias addition switch.
	Is DC superimposed on signal source?	Set the DC component of the signal generator to 0.

6. Specifications

6.1 Input

Input format

Input A, input B or addition of input A and input B

Input impedance

Within 50Ω or $600\Omega \pm 5\%$

Maximum allowable input voltage

± 10 V

Connector

BNC-R

1 for front and 1 for rear panel for both inputs A and B

6.2 Output

Maximum output voltage

50 Vrms or more	40 Hz to 500 kHz	Load of resistance 50Ω (non-inductive)
45 Vrms or more	20 Hz to 1 MHz	Load of resistance 50Ω (non-inductive)
± 75 V (150 Vp-p)	(DC to 100 kHz)	Load of resistance 100Ω (non-inductive)
± 70 V (140 Vp-p)	(DC to 500 kHz)	Load of resistance 100Ω (non-inductive)
± 65 V (130 Vp-p)	(DC to 1 MHz)	Load of resistance 100Ω (non-inductive)

Maximum output current

1 Arms (2.82Ap-p)	40 Hz to 1 MHz
± 0.75 A	DC to 40 Hz

Area of voltage and current that can be output

The maximum output current of the HSA4011 is restricted by frequency and output voltage. Moreover, the operation area also changes whether the current is a peak value or average value (DC).

☞ See "Figure 4-1 Operation Area."

Output impedance

$0.5\Omega + 1.5\mu\text{H}$ or less

$0.2\Omega + 1\mu\text{H}$ typ

6.2 Output

Output noise level **NOTE G: Gain setting**

Within $(1 + 0.1G)mV_{rms}$

Input short circuit with load of 50Ω

With frequency band of 10 Hz to 1 MHz

Output DC offset voltage

Adjustable to 0 using pre-set variable resistor

Adjustment range: ± 0.5 V or more

Temperature drift: $\pm(1 + 0.1G)mV/^{\circ}C$ typ

DC bias

± 50 V or more, using 10-turn potentiometer

Output connector

BNC-R: 1 for front and 1 for rear

GND connected to chassis

Voltage monitor output

Output impedance: $500\Omega \pm 5\%$

Load impedance: 10 k Ω or more

Gain: (Main output) $\div 100 \pm 10\%$ (no load)

Phase: In-phase with respect to input

Output connector: BNC-R front panel

Monitor meter

Function: Indicates average value of output voltage DC+AC

Full scale 60 V

Detection system: Average value detection, calibrated with sine wave

Accuracy: Within $\pm 5\%$ of full scale

Preamp output

Output impedance: $150\Omega \pm 5\%$

Load impedance: 600Ω or more

Gain: (Main output) $\div 15.6 \pm 5\%$

Phase: Inverse phase with respect to input

Output connector: BNC-R rear panel

6.3 Input/Output Characteristic

Gain

Function: Combination of four ranges of $\times 10$, $\times 20$, $\times 50$, $\times 100$ and pre-set variable resistor provides variable gain from $\times 10$ to $\times 300$.

Error: $\pm 5\%$ (frequency 400 Hz, variable setting CAL position)

Small signal frequency characteristic

Within ± 0.3 dB At DC to 100 kHz

Within ± 0.5 dB At 100 kHz to 500 kHz

Within $+0.5$ to -1 dB At 500 kHz to 1 MHz

(Variable gain setting: CAL, 400 Hz reference, 10 Vrms output, 50 Ω load)

NOTE: Within $+1$ to -4 dB, 100 kHz to 1 MHz, gain variable $\times 300$

Step response

Overshoot/sag: 5% or less

Through rate: 650 V/ μ s typ

Output ± 50 V with 50 Ω load

Harmonics distortion rate

(With output voltage of 40 Vrms, 50 Ω load)

0.1% or less: Frequency 40 Hz to 1 kHz

0.5% or less: Frequency 40 Hz to 100 kHz

3% or less: Frequency 100 kHz to 500 kHz

Phase between input/output: In-phase with respect to inputs A and B

6.4 General Specifications

Power supply

Rated frequency:	50/60 Hz
Frequency range:	48 to 62 Hz
Rated voltage:	Single-phase 100/120/200/240 V 120 V, 200 V and 240 V are option at shipment
Voltage range:	100 V: 90 to 110 V 120 V: 108 to 132 V 200 V: 180 to 220 V 240 V: 216 to 250 V
Power consumption:	60 W or less (100 VA or less) with no load 200 W or less (300 VA or less) With rated load (400 Hz, 50 Vrms, 50Ω load)

Insulation/withstand voltage

Insulation:	Between power input and chassis, other total: 30 MΩ or more at DC 500 V
Withstand voltage:	Between power input and chassis, other total: 1500 VAC/1 minute

Temperature range/humidity range

During operation:	0 to +40°C, 10 to 90% RH
During storage:	-20 to +50°C, 10 to 80% RH

External dimensions/weight

External dimensions:	Max 238 (W) × 148.5 (H) × 538 (D) mm
(Excluding handle, rubber legs):	220 (W) × 132.5 (H) × 450 (D) mm
☞ For details, see "Figure 6-1 External Dimensions."	
Weight:	Approximately 10 kg

6.5 Option

Rack mount bracket

The HSA4011 can be mounted on a standard millimeter or inch rack using auxiliary brackets. Contact our sales representative specifying either millimeter or inch.

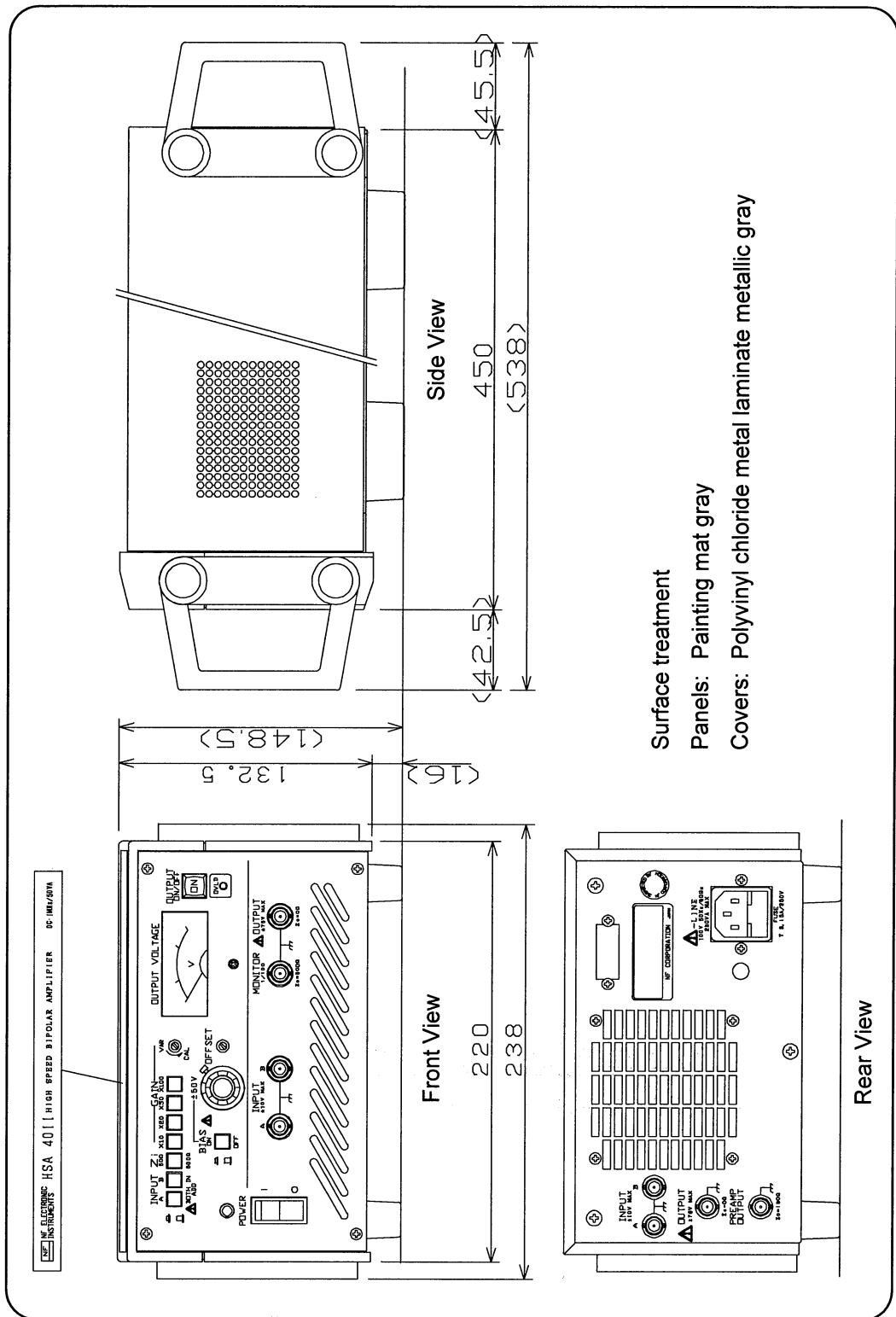

Figure 6-1 External Dimensions

WARRANTY

NF CORPORATION certifies that this instrument was thoroughly tested and inspected and found to meet its published specifications when it was shipped from our factory.

All **NF** products are warranted against defects in materials and workmanship for a period of one year from the date shipment. During the warranty period of, **NF** will, at its option, either will repair the defective product without any charge for the parts and labor, or either repair or replace products which prove to be defective. For repair service under warranty, the product must be returned to a service center designated by **NF**. Purchaser shall be prepay shipping charge, duties, and taxes for the product to **NF** from another country, and **NF** shall pay shipping charge to returned the product to purchaser.

This warranty shall not apply to any defect, failure or damage caused by improper use, improper or inadequate maintenance and care or modified by purchaser or personnel other than **NF** representatives.

NF CORPORATION

If there are any misplaced or missing pages, we will replace the manual. Contact the sales representative.

NOTES

- Reproduction of the contents of this manual is forbidden by applicable laws.
- The contents of this manual may be revised without notice.
- Information provided in this manual is intended to be accurate and reliable. However, we assume no responsibility for any damage regarding the contents of this manual.
- We assume no responsibility for influences resulting from the operations in this manual.

Copyright 2000, *NF CORPORATION*

NF CORPORATION

3-20 Tsunashima Higashi 6-chome, Kohoku-ku. Yokohama-shi
223-8508, JAPAN

Phone: 81-45-545-8128 Fax: 81-45-545-8187 Telex: 3823-297

