



WAVE FACTORY

MULTIFUNCTION SYNTHESIZER

**WF1945B**

---

INSTRUCTION MANUAL



WF1945B  
MULTIFUNCTION  
SYNTHESIZER  
**Instruction Manual**

WAVE FACTORY

---



# Foreword

Thank you very much for procuring the WF1945B MULTIFUNCTION SYNTHESIZER. At the outset, please take a few minutes to read the Safety Precautions indicated in this manual in order to use this equipment safely and correctly.

## ● Warning and Caution notices

The following Warning and Caution notices appear in this manual. These must be observed in order to protect both the user from physical harm and the equipment from damage.



### WARNING

Risk of serious and possibly fatal physical injury from electric shock or other cause.



### CAUTION

Risk of damage to the equipment.

## ● Manual composition

Please read Section 1 before using the equipment for the first time. Refer to a separate volume for a description of remote control (GPIB or USB).

### Section 1 Overview

Provides a general description of the equipment and a simple outline of the operating principles.

### Section 2 Preparation

Required preparatory work before installing and operating the equipment. Be sure to read this section.

### Section 3 Basic operation

Panel functions, operating principles and basic operations are described. Read while operating the equipment.

### Section 4 Applications

Expanded operations are described.

### Section 5 Other operations

Operations not covered in Sections 3 and 4 are described.

### Section 6 Troubleshooting

Corrective measures when error messages or abnormalities occur.

### Section 7 Maintenance

Inspection and performance tests are described.

### Section 8 Specifications

Equipment specifications (functions and performance) are described.

# Safety Precautions

Observe the following warnings and cautions in order to use this equipment safely. No responsibility or warranty is assumed for damages arising from use in a manner contrary to these warnings and cautions.

This product is an insulation standard class I device (with a protective conductor terminal) as defined by the IEC standards.

## ● **Observe text instructions**

This manual has been compiled in order to enable safe operation and use of this equipment. Be sure to read this manual before using the equipment.

Items designated by Warning advise of serious physical hazards. Be sure to observe these carefully.

## ● **Be sure to connect ground**

Since the unit includes a built-in line filter, there is risk of shock if used without grounding.

To prevent electric shock, be sure to properly connect the device to the electric ground which ground resistance is less than 100  $\Omega$ .

## ● **Confirm power source voltage**

Before connecting this equipment, check that the proper voltage is being supplied to the power outlet.

Refer to the Grounding and Power Supply section of this manual.

## ● **Use only the properly rated fuse**

Improperly rated fuses present a fire hazard and other risks. Refer to the Grounding and Power Supply section of this manual and confirm the fuse rating.

Be sure to disconnect the equipment from the power source before replacing the fuse.

## ● **Smoke, odor, noise**

In event smoke, peculiar odor or noise is emitted, immediately disconnect the power source and avoid further operation. Contact service.

## ● **Flammable gas**

Do not use this equipment in the presence of flammable gas. There is danger of fire and explosion.

## ● **Do not remove covers**

This equipment contains dangerously high voltages. Do not remove external covers.

Refer all internal inspection and service to a qualified service technician who fully understands the hazards.

● **Do not modify**

Do not use parts other than specified by the manufacturer and by no means attempt to modify the equipment. There is risk of personnel hazard and damage to the equipment. The manufacturer reserves the option of refusing service in such cases.

● **Safety related symbols and indications**

Following are general definitions of the symbols and indications used in the text and on the product.



Advises of possible hazard to the user, as well as the need to consult this manual when using an operation or function.



Appears in the text and on the product to advise risk of fatal or otherwise serious physical injury.



Appears in the text and on the product to advise risk of damage to the product.



Ground indication:

Indicates connector housing and signal ground is connected to a chassis ground.



Indicates power switch on state.



Indicates power switch off state.





# Contents

● Foreword .....	i
● Safety Precautions .....	ii
● Section 1 Overview .....	1-1
1.1 Features .....	1-2
1.2 Operating principles .....	1-3
■ Block diagram .....	1-3
1.3 Function outline .....	1-4
■ Function tree .....	1-4
● Section 2 Preparation .....	2-1
2.1 Check before using .....	2-2
■ Safety check .....	2-2
■ Unpacking and repacking .....	2-2
2.2 Power source and grounding .....	2-4
■ Grounding .....	2-4
■ Line filter .....	2-4
■ Power source .....	2-4
■ Power supply fuse .....	2-6
2.3 Installation .....	2-7
■ Cautions .....	2-7
■ Installation conditions .....	2-7
■ Panel and case cleaning .....	2-7
2.4 Conformance standards .....	2-8
2.5 Calibration .....	2-9
● Section 3 Basic Operation .....	3-1
3.1 Panel description .....	3-2
■ Front panel .....	3-3
■ Rear panel .....	3-4
3.2 Input and output connectors .....	3-5
■ Waveform output (FUNCTION OUT) .....	3-5
■ Sync signal output (SYNC OUT) .....	3-6
■ Trigger/sweep input (TRIG/SWEEP IN) .....	3-9
■ Sweep stop/restart input (SWEEP PAUSE IN) .....	3-10
■ Sweep X-drive output (SWEEP X-DRIVE OUT) .....	3-10

- Sweep marker output (SWEEP Z-MARKER OUT)..... 3-11
    - External add input (EXT ADD IN) ..... 3-11
    - External AM input (EXT AM IN)..... 3-12
    - Synchronous operation input and output ( $\phi$ -SYNC IN, OUT)..... 3-12
    - Digital output (DIGITAL OUT)..... 3-14
  - 3.3 Basic operation ..... 3-16
    - Setting initialize(PRESET) ..... 3-16
    - Oscillation mode selection ..... 3-19
    - Waveform selection ..... 3-20
    - Frequency setting ..... 3-23
    - Amplitude setting ..... 3-24
    - DC offset setting ..... 3-25
    - Phase setting ..... 3-26
    - Output on/off ..... 3-27
    - Operation tree ..... 3-28
- Section 4 Applications..... 4-1
  - 4.1 Burst oscillation ..... 4-2
    - Burst oscillation (Type: Burst)..... 4-2
    - Burst oscillation (Type: Trigger)..... 4-5
    - Burst oscillation (Type: Gate) ..... 4-9
    - Burst oscillation (Type: Triggered Gate)..... 4-13
  - 4.2 Sweep ..... 4-16
    - Sweep (Mode: Single)..... 4-16
    - Sweep (Mode: Continuous)..... 4-22
    - Sweep (Mode: Gated) ..... 4-27
    - CENTER, SPAN, MARKER, MKR → CTR ..... 4-34
    - Summary of the sweep setting items ..... 4-35
    - Sweep (modulation) steps and step width..... 4-36
    - Sweep value and Z-MARKER/SYNC/X-DRIVE outputs ..... 4-38
  - 4.3 Modulation ..... 4-40
    - Frequency modulation (FM) ..... 4-40
    - Amplitude modulation (AM)..... 4-43
    - DC offset modulation (OFSM)..... 4-46
    - Phase modulation (PM)..... 4-49
    - Pulse width modulation (PWM)..... 4-52
  - 4.4 Arbitrary Waveform..... 4-55
    - Arbitrary waveform (ARB)..... 4-55

---

4.5	Selecting waveforms of synchronous signals (SYNC OUT)	4-60
■	Procedure	4-60
■	When the oscillation mode is BURST	4-60
■	When the oscillation mode is SWEEP	4-61
■	When the oscillation mode is MODU	4-61
■	Additional information	4-62
4.6	Output waveforms for sweeping and modulation	4-63
4.7	Equivalent noise bandwidth	4-65
●	Section 5 Other Operations	5-1
5.1	Convenient Settings	5-2
■	Frequency [Hz] setting by period [s]	5-2
■	Squarewave duty setting	5-3
■	Squarewave pulse width setting	5-4
■	Amplitude and DC offset setting by high and low level	5-5
5.2	Units	5-7
■	Engineering unit ( $\mu$ , m, k, M) display	5-7
■	Amplitude units change	5-8
■	User-unit setting	5-9
5.3	Setting memory	5-13
■	Setting store	5-13
■	Setting recall	5-14
■	Setting memory clear	5-15
5.4	External Input	5-16
■	External add (EXT-ADD)	5-16
■	External AM (EXT-AM)	5-17
5.5	Other settings	5-18
■	Output range change (use with fixed range)	5-18
■	Output on/off at power on	5-19
■	LOAD function (equalize setting and output values)	5-20
■	UNDO function	5-21
■	Pulse generator function	5-22
■	Phase sync	5-24
●	Section 6 Troubleshooting	6-1
6.1	Error message	6-2
■	Power on error	6-2
■	Operation error	6-3

6.2 Suspected failure.....	6-5
■ In case of abnormality.....	6-5
● Section 7 Maintenance.....	7-1
7.1 Outline.....	7-2
■ Work contents.....	7-2
■ Required test instruments.....	7-2
7.2 Operation checks.....	7-3
■ Preparatory checks.....	7-3
■ Function checks.....	7-3
7.3 Performance tests.....	7-5
■ Performance tests.....	7-5
■ Preparatory checks.....	7-5
■ Test preparation.....	7-5
■ Frequency accuracy.....	7-5
■ Amplitude accuracy.....	7-6
■ DC offset accuracy.....	7-6
■ Amplitude vs. frequency characteristics.....	7-7
■ Sinewave distortion.....	7-7
■ Squarewave response.....	7-8
■ Duty factor.....	7-8
● Section 8 Specifications.....	8-1
8.1 Waveform and output characteristics.....	8-2
8.2 Output voltage.....	8-4
8.3 Other functions.....	8-5
8.4 Initialized settings.....	8-10
8.5 Remote control.....	8-11
8.6 Options.....	8-12
8.7 General items.....	8-13
■ External drawing.....	8-14
● Index.....	Index

# Section 1 Overview

- 1.1 Features .....1-2
- 1.2 Operating principles.....1-3
  - Block diagram.....1-3
- 1.3 Function outline.....1-4
  - Function tree .....1-4

## 1.1 Features

The WF1945B Wave Factory is a multifunctional synthesizer based on the direct digital synthesizer (DDS) system.

The WF1945B is single channel, but the series also includes the 2-channel WF1946B, the single-channel WF1943B with basic functions, and the 2-channel WF1944B with basic functions.

- Frequency setting range : 0.01  $\mu$ Hz to 15 MHz
- Maximum output voltage : 20 V<sub>p-p</sub>/open,  $\pm$ 10 V/open
- Waveform resolution: 16 bits
- Key navigation lights the next keys to be operated, thus improving operational ease.
- User units function allows setting formula and character string to convert settings and display to the desired units.
- LOAD function aligns the setting and actual output voltages when an arbitrary load impedance is connected.
- Convenient use as a pulse generator with pulse period, width, high level and low level setting and display. A trigger delay function is also included.
- Five standard waveforms: sine wave, triangular wave, square wave, rising sawtooth and descending sawtooth, plus arbitrary waveform.
- Frequency change and frequency sweep are coupled with phase, avoiding waveform cutoff.
- Unpredicted voltage is not produced during amplitude change. Since the output range is fixed, the amplitude can be changed from 0 to maximum without waveform cutoff.
- Versatile oscillation modes
  - Continuous
  - Intermittent: Burst, trigger, gate, in addition to triggered gate for repeated oscillation start/stop
  - Sweep: Sweep for not only frequency, but also phase, amplitude, DC offset and duty
  - Modulation: FM (FSK), phase (PSK), AM, DC offset and PWM
  - White noise generator
  - DC voltage generator
- Floating inputs and outputs to prevent ground loop effects.
- The 1991 synchronous operation option enables synchronized operation of multiple units and operation as an oscillator with increased number of channels.
- The 1992A digital output option can provide a 15 bit digital signal corresponding to the output waveform and enable use as a digital pattern generator.

## 1.2 Operating principles

### ■ Block diagram

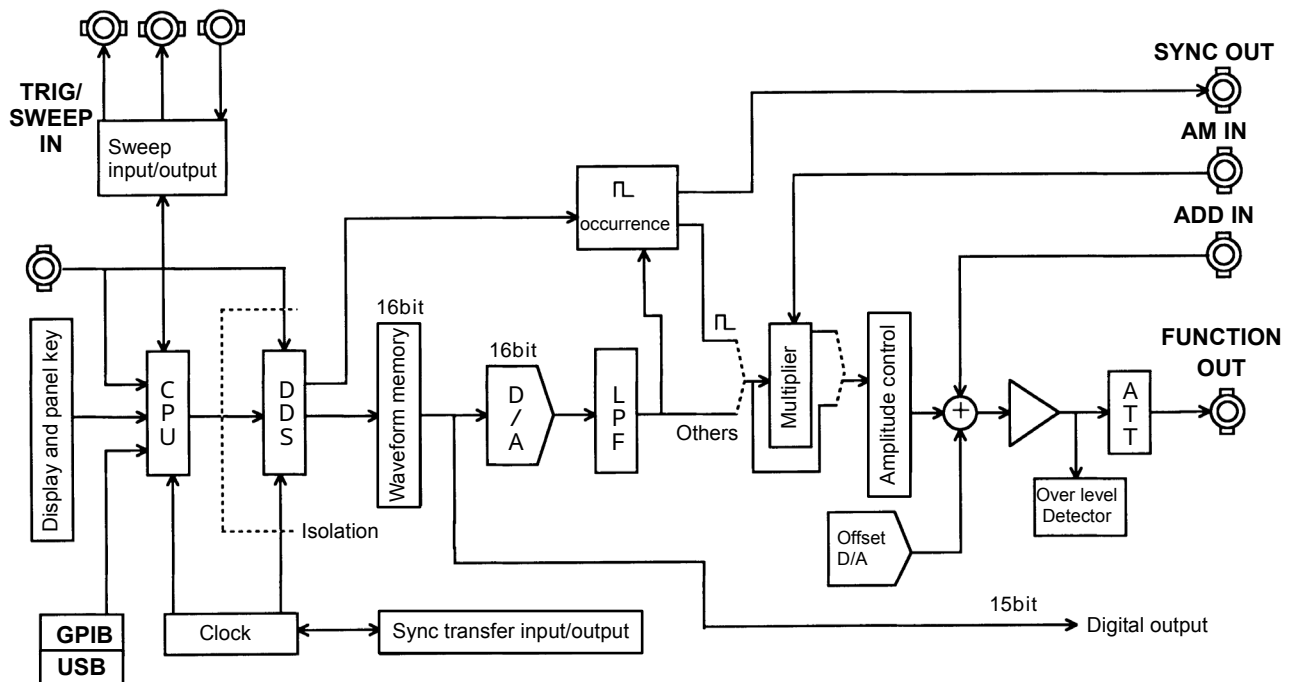

- The CPU conducts analog control for display, panel keys, remote control (GPIB, USB), DDS, amplitude and DC offset. Sweep input/output is also controlled for sweep internal/external modulation.
- The clock generator produces DDS reference and CPU clock signals.
- An isolation circuit between the CPU and DDS provides floating functions.
- The DDS (Direct Digital Synthesizer) uses an original LSI device and generates digital data of the setting frequency.
- The waveform memory converts digital data from the DDS into standard or arbitrary waveform data. Waveform data are set from the CPU.
- The digital to analog (D/A) converter produces an analog signal from the resulting waveform data.
- The lowpass filter (LPF) smoothes the stepped D/A output signal.
- Amplitude control is set by the gain control. DC offset is produced by the offset D/A converter and the output amplifier adds and amplifies the output signal.
- The attenuator (ATT) selects the output range by 1/10 attenuation on/off.

## 1.3 Function outline

### ■ Function tree

- **Oscillation mode selection**

The oscillation type can be set for continuous, intermittent, sweep, modulated, noise or DC.

- **Waveform selection**

The waveform type can be set for sinewave (  $\sim$  ), triangle waveform (  $\wedge$  ), squarewave (  $\square$  , 50 % fixed duty), squarewave (  $\square$  , variable duty), rising sawtooth (  $\nearrow$  ), descending sawtooth (  $\searrow$  ), or arbitrary (ARB).

- **Frequency setting**

The frequency can be set by the keypad or modify dial.

The period, i.e., inverse of frequency, can also be set.

The duty and pulse width can also be set for the variable duty squarewave.

- **Amplitude setting**

The amplitude can be set by the keypad or modify dial.

- **DC offset setting**

The DC offset can be set by the keypad or modify dial.

- **Phase setting**

Phase between channels and oscillation starting phase during burst oscillation can be set.



- **Output on/off**

The waveform and sync signal output connectors are on/off switchable for each channel.

The setting prior to power off is returned at power on. Be sure to set to either on or off as required.

- **User units setting**

Coefficients and compensation can be applied to frequency, period, amplitude, DC offset, phase and duty for setting and displaying these in desired units. The units can be expressed by up to 4 desired characters.

- **Setting store and recall**

The settings for frequency, amplitude, etc., can be stored and recalled.

The WF1945B is capable of 10 combinations store/recall.

- **Computer control**

Remote control (GPIB or USB) enables external control from a personal computer.

■ Function tree

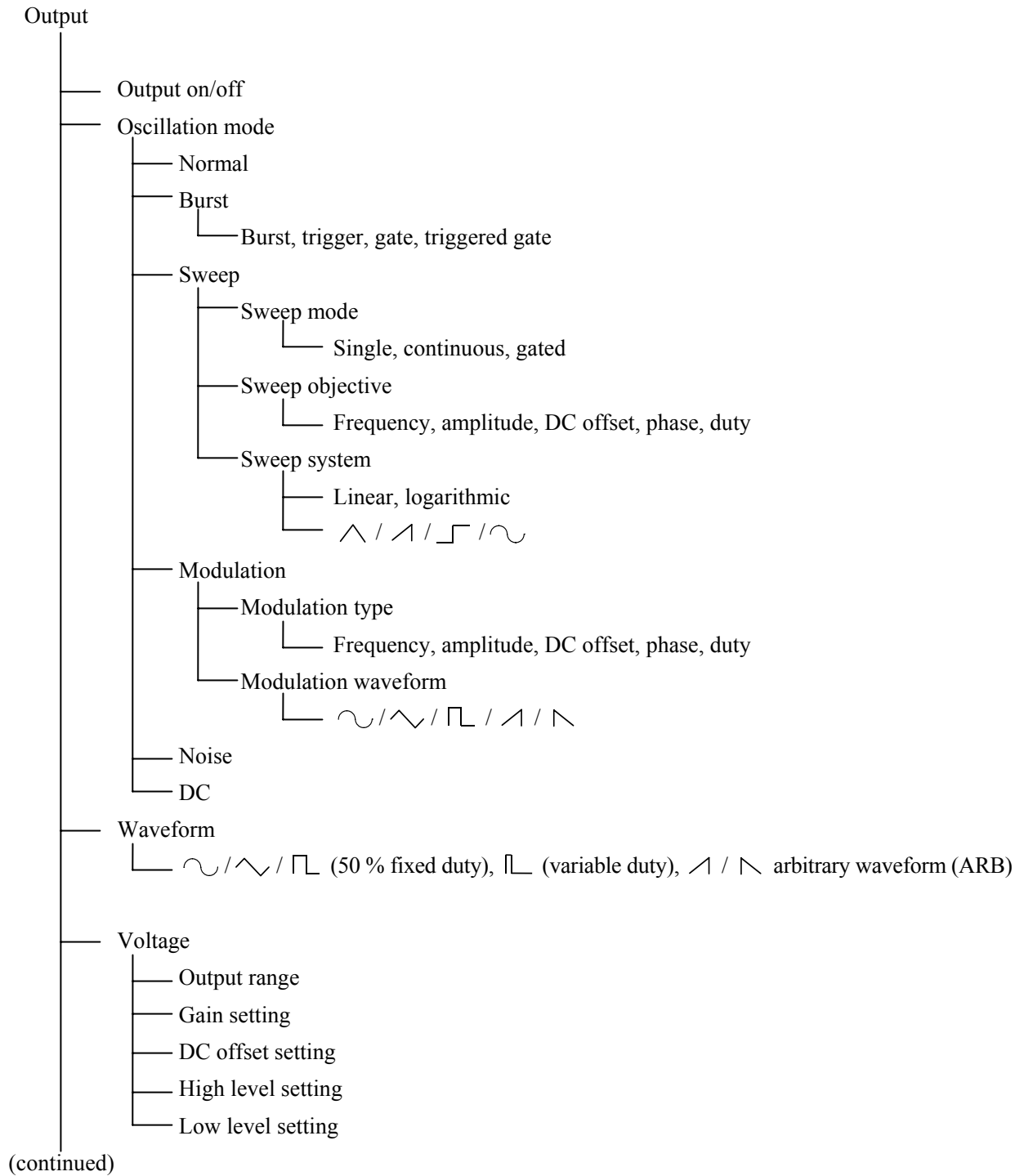

## Output (continued)

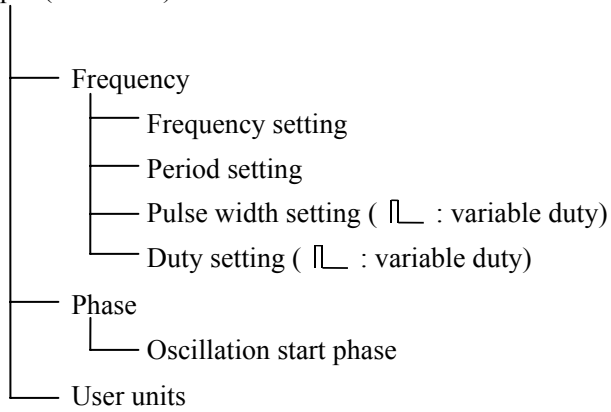

## Setting contents

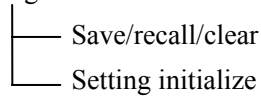

## Communication

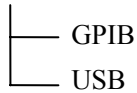

## Others

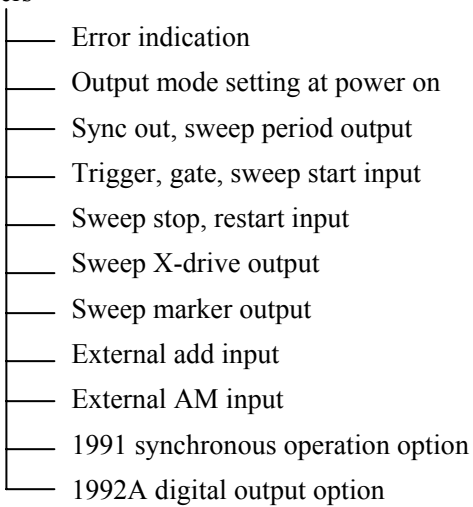



## Section 2 Preparation

2.1	Check before using	2-2
■	Safety check	2-2
■	Unpacking and repacking	2-2
2.2	Power source and grounding	2-4
■	Grounding	2-4
■	Line filter	2-4
■	Power source	2-4
■	Power supply fuse	2-6
2.3	Installation	2-7
■	Cautions	2-7
■	Installation conditions	2-7
■	Panel and case cleaning	2-7
2.4	Conformable standards	2-8
2.5	Calibration	2-9

## 2.1 Check before using

### ■ Safety check

Before using the WF1945B, refer to the **Safety precautions** of this manual and confirm safety.

Also, before connecting the power, refer to **Section 2.2 Power source and grounding** and thoroughly check the safety.

### ■ Unpacking and repacking

First, inspect the equipment for possible damage in shipping.

Check for the presence of the following items.

Mainframe .....	1
Instruction Manual .....	1
Remote Control Instruction Manual .....	1
0105 Arbitrary Waveform Editor (CD-ROM) .....	1
Supplied accessories	
Power cable: (3-conductors) .....	1
Fuse : (100/115 V: 1 A or 230 V: 0.5 A) .....	1
(Time lag, 250 V, $\phi$ 5.2 × 20 mm)	

For information on how to use 0105 Arbitrary Waveform Editor, refer to the CD-ROM of the 0105.

When repacking the equipment for transportation, use a packing carton having ample strength to protect the equipment and bear the weight of stacking.



### WARNING

**Do not remove covers.**

**This equipment contains dangerously high voltages. Do not remove external covers.**

**Refer all internal inspection and service to a qualified service technician who fully understands the hazards.**

■ **1991 synchronous operation option**

If ordered, this option is installed at time of shipment.

■ **1994 synchronous operation cable**

Cable (1 meter) used with the 1991 synchronous operation option.

The required number of cables is one less than the total number of connected units.

■ **1992A digital output option**

If ordered, this option is installed at time of shipment.

The following accessory cable is also provided.

Supplied accessory	
Digital output cable (1 meter) .....	1

## 2.2 Power source and grounding

### ■ Grounding

#### WARNING

This equipment must be grounded in order to prevent electric shock accidents.

Confirm the protective ground terminal is connected to ground before connecting the equipment for measurements. The WF1945B protective ground is connected to ground by the 3-prong power supply plug.

Use the supplied power supply cable to connect to a 3-terminal power outlet that has a protective ground contact.

### ■ Line filter

The WF1945B uses a line filter that incorporates the circuit below.

Because the maximum leakage current is 0.5 mArms at 250 V/62 Hz, touching a metallic part of the WF1945B could cause an electric shock.

For your safety, be sure to ground the device.

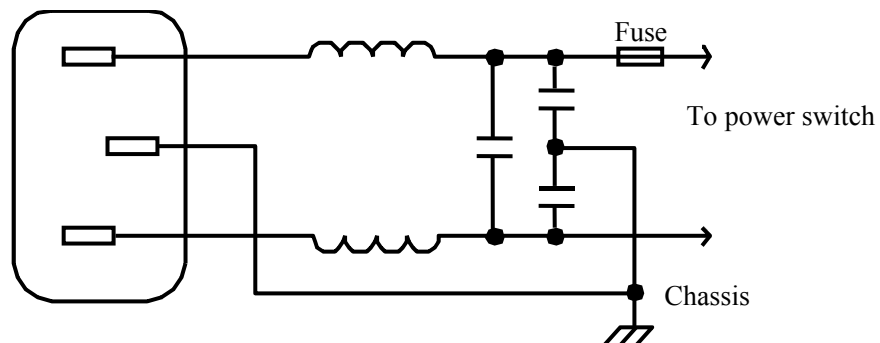

### ■ Power source

#### CAUTION

Be sure to observe the following in order to prevent damage to the equipment.

Confirm the power source voltage is within the range specified for the WF1945B.



Check the power source voltage indication on the rear panel above the power source inlet. The WF1945B operates from the following commercial power source.

Power supply voltage range:	AC100V/115V/230V±10%
Power supply frequency range:	50/60 Hz ±2 Hz
Power consumption:	Max. 65 VA
Overvoltage category:	II

Connect to the power source according to the following procedure:

1. Set the WF1945B power switch to off.
2. Adjust the source voltage change-over switch at the back of the unit to the source voltage to be used.
3. Insert the power cable into the power inlet on the back of the unit.
4. Insert the power cable plug into a 3-terminal wall socket.

With a screwdriver, move the slide control of the source voltage change-over switch to the line indicating the source voltage to be used. Do not set the slide control between lines.

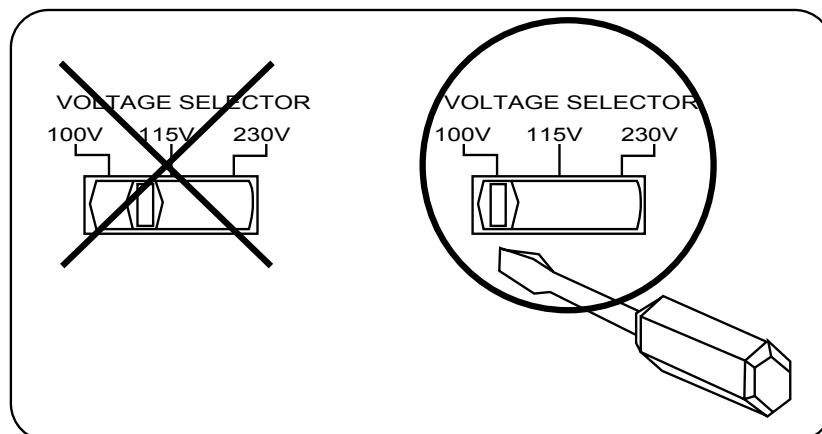

Before using the WF1945B with a source voltage that differs from the factory setting, be sure to contact the sales representative of NF Corporation.

Make sure that the power switch is off before connecting the power cable. Also, after switching power off, wait at least five seconds before switching the power on again.

Confirm the power switch is off before connecting the power cable.

Also, after switching power off, wait at least 5 seconds before again switching power on.

## ■ Power supply fuse



### WARNING

**Use only a fuse with the specified rating.**

**There is risk of fire from an improperly rated fuse. Be sure to disconnect the power cable before replacing the fuse.**

Fuse: Time lag 1 A (100/115 V) or time lag 0.5 A (230 V)  
250 V,  $\phi 5.2 \times 20$  mm

The specified rating of a fuse changes depending on the power source voltage.

## 2.3 Installation

### ■ Cautions



Observe the following cautions to avoid damaging the WF1945B.

- The unit is cooled by a fan. In event the fan does not function, switch off the power and contact service. Continued use without the fan operating can lead to extensive damage and service complexity.
- Ventilation openings are located on the side and rear panels. Avoid obstructing the openings and provide at least 10 cm clear space at the sides and back of the unit when installing.
- Do not use the unit vertically (with the rear panel downward).

### ■ Installation conditions

Observe the following ambient when installing and storing the equipment. Moisture condensation must also be absent.

Temperature and humidity ranges

Guaranteed performance: +5 to +35 °C, 5 to 85 %RH  
(no condensation at an absolute humidity of 1 to 25 g/m<sup>3</sup>)

Ambient storage conditions: -10 to +50 °C, 5 to 95 %RH  
(no condensation at an absolute humidity of 1 to 29 g/m<sup>3</sup>)

Pollution degree : 2

Avoid installing the equipment in the following types of locations.

- In direct sunlight or near heat sources
- Where subjected to dust, salt or metallic dust
- Corrosive gas, steam or oily smoke
- Flammable gas or vapors
- Strong vibration
- Strong magnetic or electromagnetic fields
- Near pulse type noise sources

Also, when using, provide separation between the power cords and signal cables of the WF1945B and those of other equipment. Operating error can occur if the power cords and signal cables are too close. Cable routing requires particular attention when installing in a rack or other facility.

### ■ Panel and case cleaning

Use a soft cloth to wipe dust from the panel and case. If soiling is severe, moisten the cloth slightly with a neutral detergent.

Do not use sprays, petroleum distillates or commercial cleaning cloths, which can deform or peel the finish.

## 2.4 Conformable standards

The WF1945B conforms to the following standards.

Safety: EN 61010-1: 2001

EMC: EN 61326: 1997/A1: 1998/A2: 2001

However, the performance criteria for the following standards are as follows:

EN61000-4-2(1995), EN61000-4-4(1995), EN61000-4-5(1995), and EN61000-4-11(1994):B

The following cables are used for the test of EN 61326: 1997/A1: 1998/A2: 2001

- Power cable : Accessory
- Signal cables : Coaxial cable with BNC connectors, 1 m (3D-2W or RG-143B/U or RG-223/U)
- GPIB cable : Shielded cable, 1 m (DDK: 408JE-101)

## 2.5 Calibration

**Section 7.3** the **Performance tests** are recommended at least once a year. These should also be conducted before important tests and measurements.



## Section 3 Basic operation

3.1	Panel description	3-2
■	Front panel	3-3
■	Rear panel	3-4
3.2	Input and output connectors	3-5
■	Waveform output (FUNCTION OUT)	3-5
■	Sync signal output (SYNC OUT)	3-6
■	Trigger/sweep input (TRIG/SWEEP IN)	3-9
■	Sweep stop/restart input (SWEEP PAUSE IN)	3-10
■	Sweep X-drive output (SWEEP X-DRIVE OUT)	3-10
■	Sweep marker output (SWEEP Z-MARKER OUT)	3-11
■	External add input (EXT ADD IN)	3-11
■	External AM input (EXT AM IN)	3-12
■	Synchronous operation input and output ( $\phi$ -SYNC IN, OUT)	3-12
■	Digital output (DIGITAL OUT)	3-14
3.3	Basic operation	3-16
■	Setting initialize(PRESET)	3-16
■	Oscillation mode selection	3-19
■	Waveform selection	3-20
■	Frequency setting	3-23
■	Amplitude setting	3-24
■	DC offset setting	3-25
■	Phase setting	3-26
■	Output on/off	3-27
■	Operation tree	3-28

• Following is an example of the display when using this section.

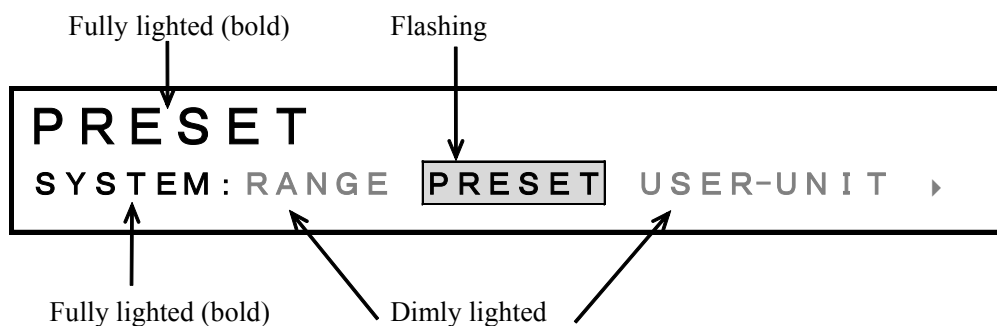

## **3.1 Panel description**

This section describes the indications and functions of the front and rear panels of the WF1945B.



■ Front panel

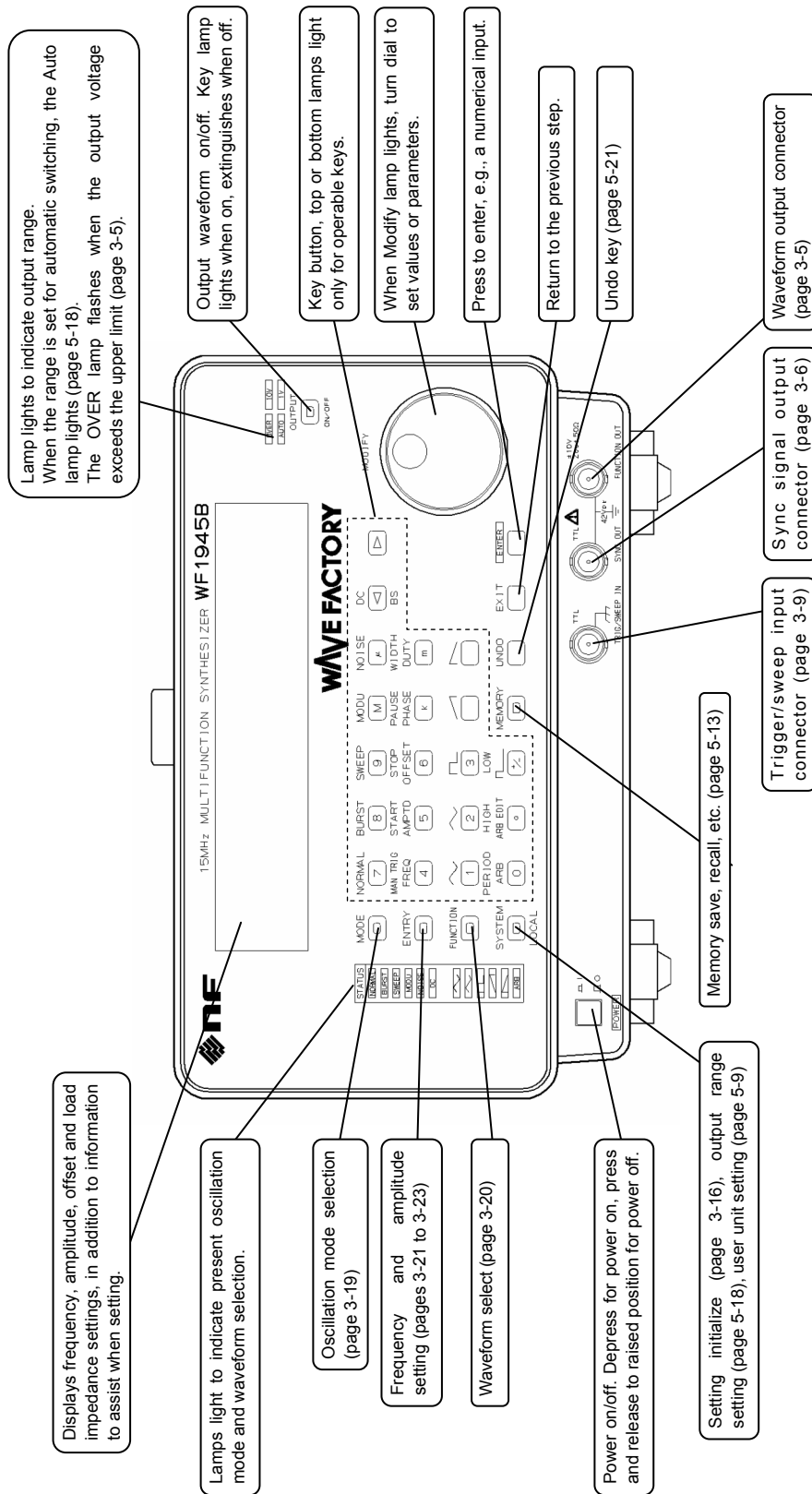

■ Rear panel

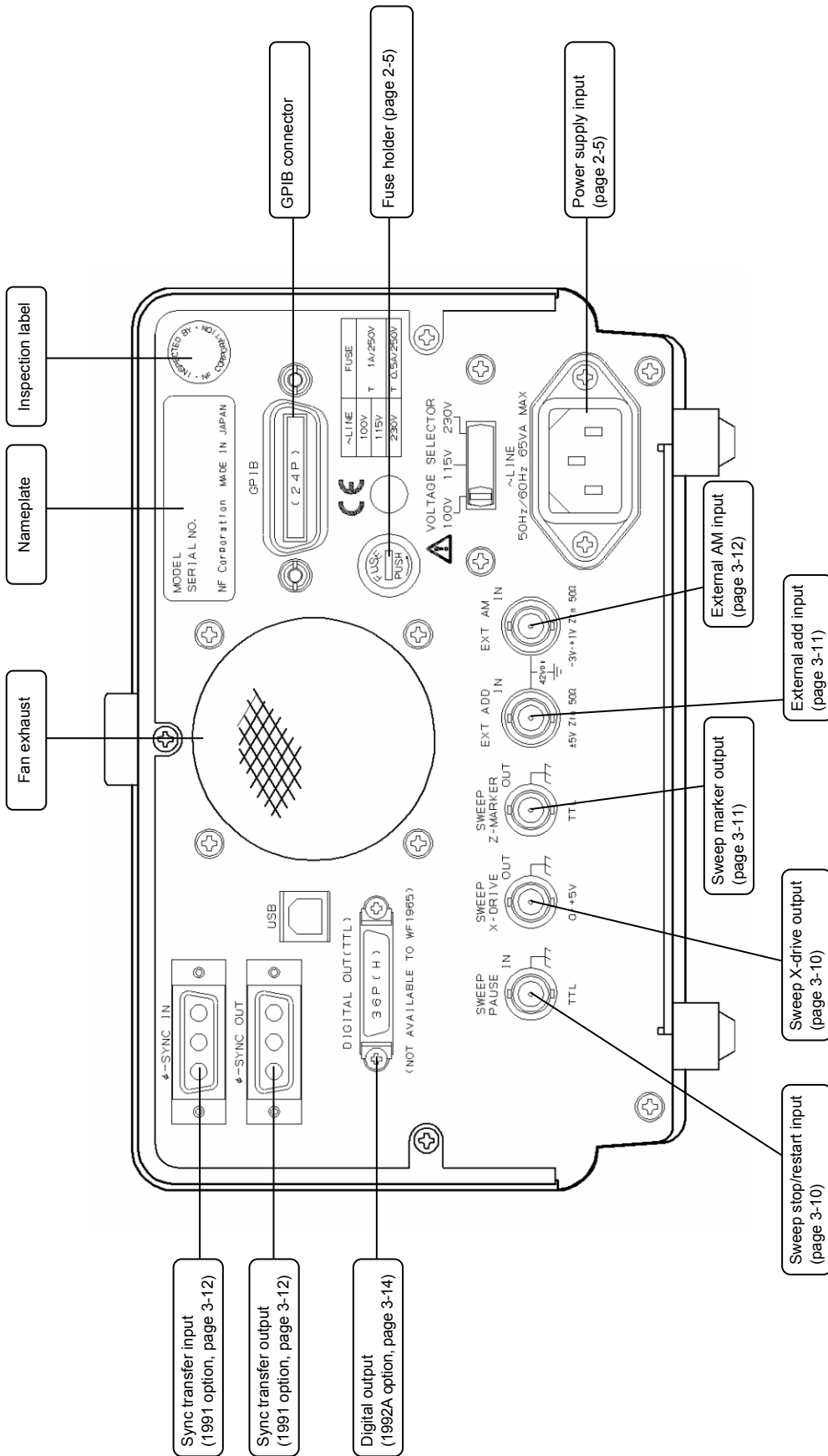

## 3.2 Input and output connectors

### ■ Waveform output (FUNCTION OUT)

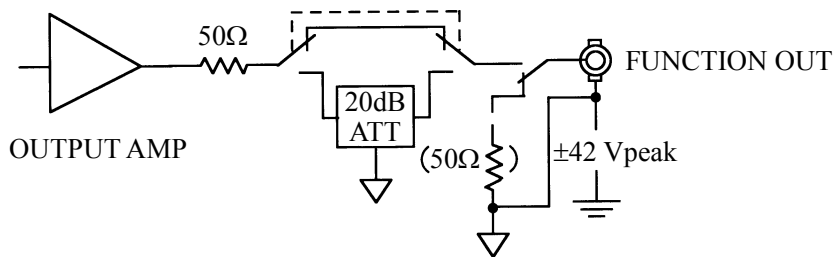

Maximum output voltage : 20 V<sub>p-p</sub>/open, 10 V<sub>p-p</sub>/50 Ω load

Output impedance : 50 Ω, unbalanced

Load impedance: More than 45 Ω

Output off status : Open when output off (can be modified for 50 Ω at output off. Consult company.)

Ground : Connected to signal ground (floating from chassis)

### ⚠ CAUTION

**Avoid shorting the output or applying an external signal. The unit can be damaged.**

#### • Output limiting

If the following voltages are exceeded by the amplitude, DC offset, external add or external AM settings, the OVER lamp flashes and the output is clipped.

10 V range: Approx. 11 V<sub>p</sub>/open

1 V range: Approx. 1.1 V<sub>p</sub>/open

#### • Output connection note

The Function Out impedance is 50 Ω. By using coaxial cable with 50 Ω characteristic impedance for connection to other equipment, amplitude accuracy at high frequency can be improved and waveform disturbance reduced. In addition, performance deterioration up to maximum frequency can be prevented by connecting to a terminal having 50 Ω input impedance or terminating the input at 50 Ω.

#### • Setting and output voltages

The setting voltage display and actual output voltage (load terminal voltage) differ according to the load resistance.  "5.4 Other settings (■LOAD function (equalize setting and output values))", cf.

■ Sync signal output (SYNC OUT)

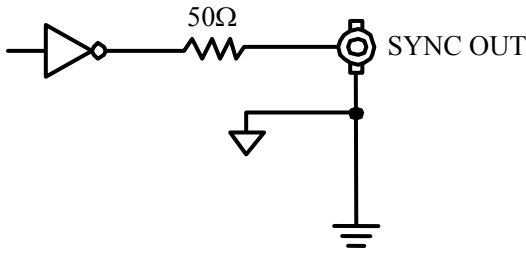

- Output waveform : □
- Output voltage : 0 V/+5 V (open)
- Output impedance: 50 Ω, unbalanced
- Load impedance: More than 45 Ω
- Status at output off : High impedance
- Ground : Connected to signal ground (floating from chassis)



**Avoid shorting the output or applying an external signal. The unit can be damaged.**

• Output connection note

The Sync Out impedance is 50 Ω. By using coaxial cable with 50 Ω characteristic impedance for connection to other equipment, waveform disturbance can be reduced. Although 50 Ω termination is possible, the high level voltage is reduced by about half.

• Waveform and sync signal output relationship (Waveform phase definition)

(1) Continuous oscillation mode (NORMAL)

① Sinewave

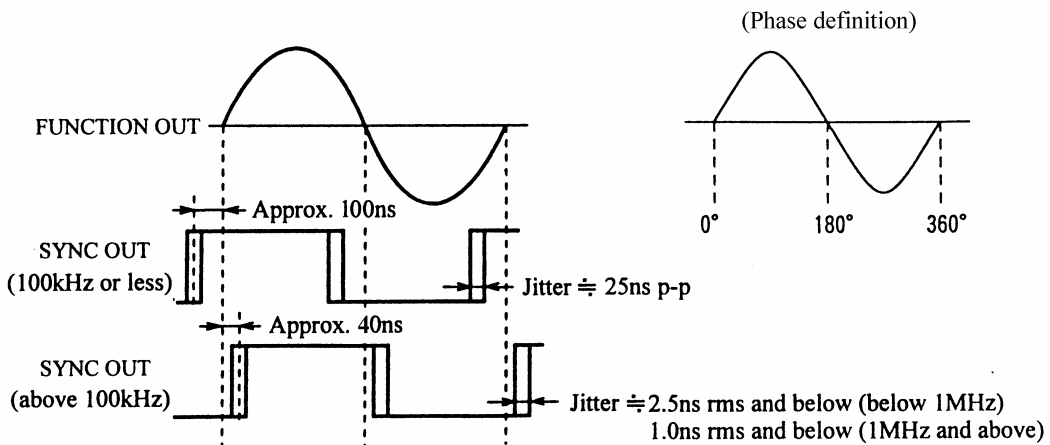

② Triangular, rising sawtooth, descending sawtooth, arbitrary

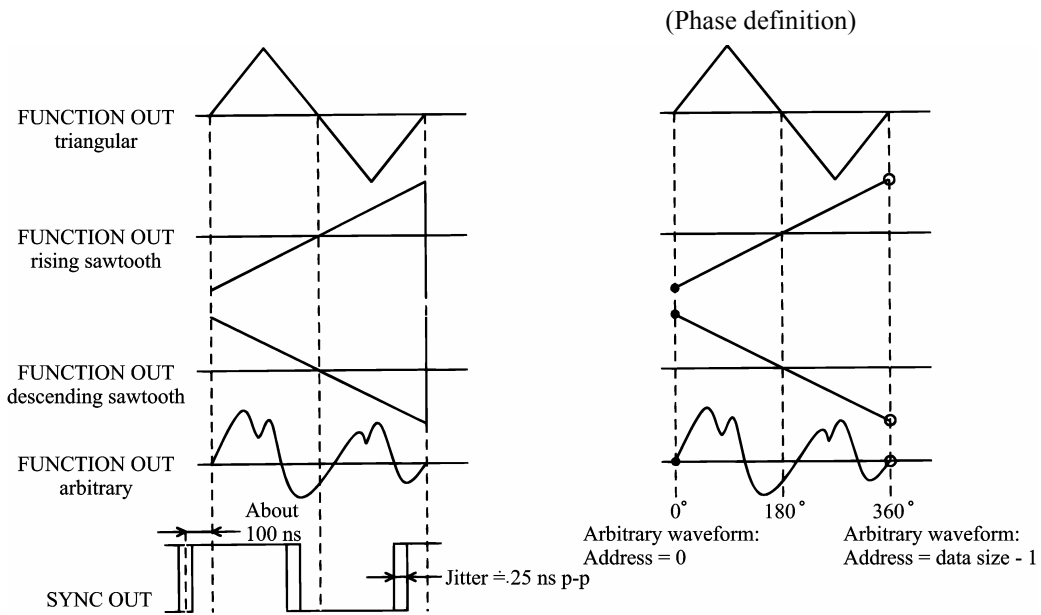

③ Squarewave (fixed 50 % duty)

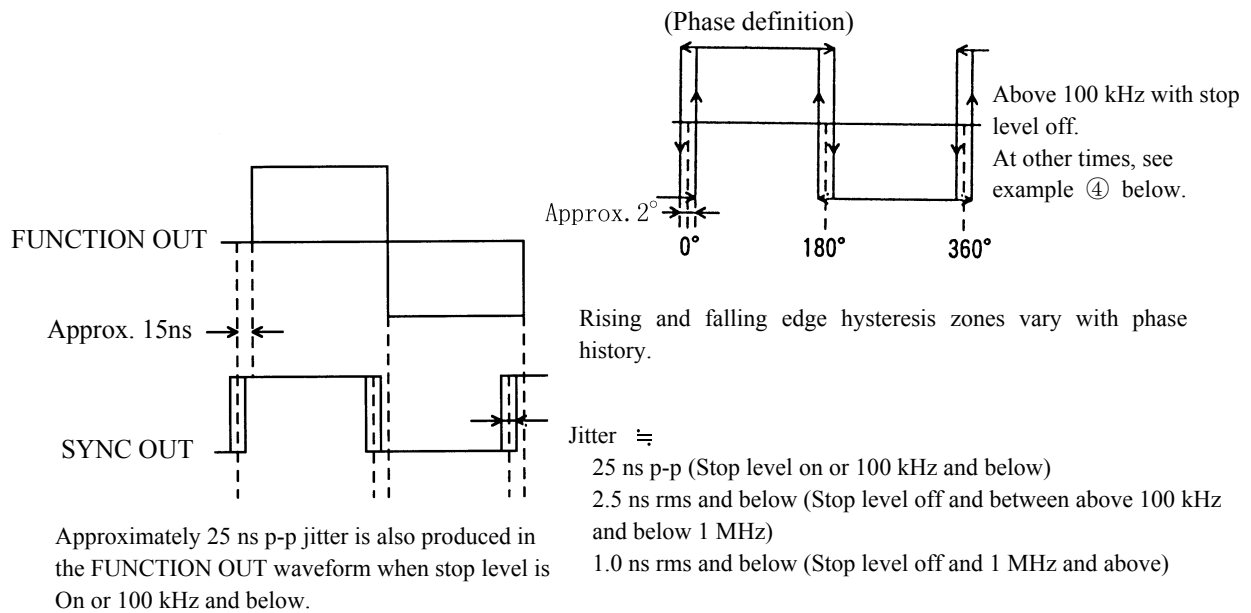

④ Squarewave (variable duty)

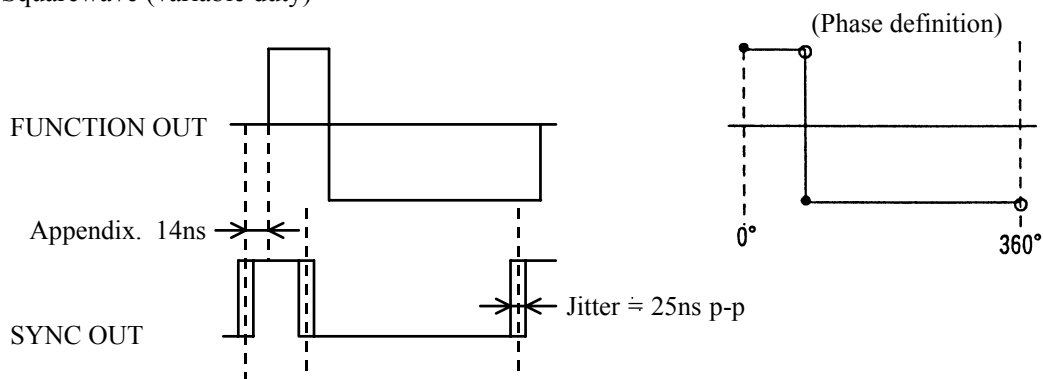

Approximately 25 ns p-p jitter is also produced in the FUNCTION OUT waveform.

**(2) Burst mode (BURST)**

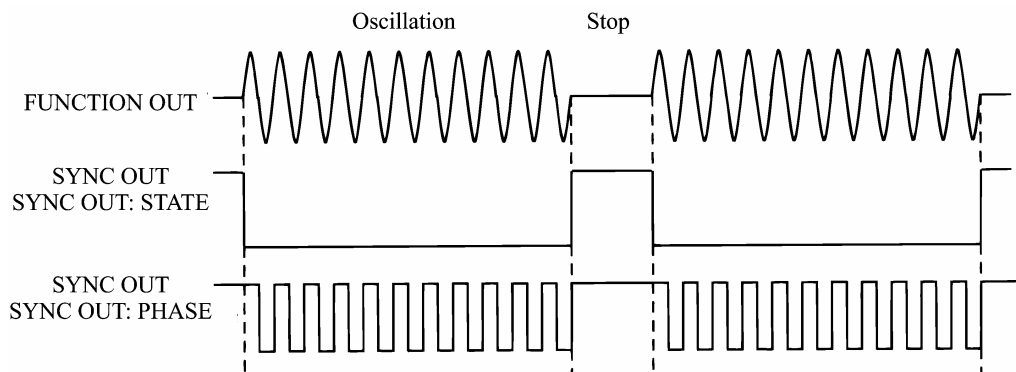

**(3) Sweep mode (SWEEP)**

Low level during sweep from start to stop points. High level at other times.

"4.2 Sweep (■ Sweep value and Z-MARKER/SYNC/X- DRIVE outputs)", cf.

**(4) Modulation mode (MODU)**

High level when modulation waveform phase is above 0 and less than 180 degrees. Low level above 180 and below 360 degrees.

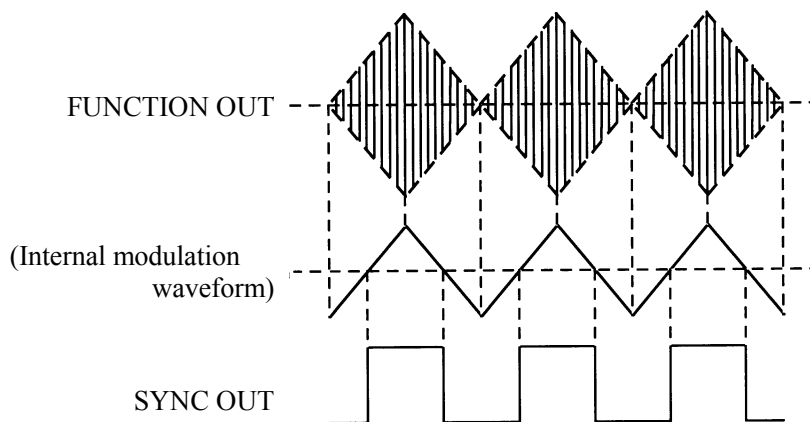

**(5) Noise mode (NOISE)**

Digital (binary) noise source output.

**(6) DC mode (DC)**

Always high level.

## ■ Trigger/sweep input (TRIG/SWEEP IN)

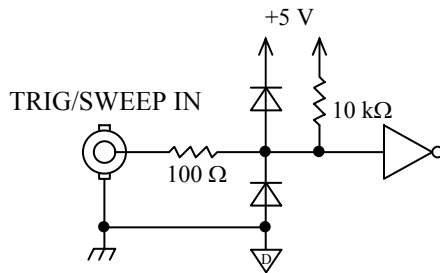

Signal characteristics: The following types are produced during the burst oscillation mode.

- Trigger: Select oscillation start for either  $\uparrow$  or  $\downarrow$ .
- Gate: Select oscillation at either high or low level.
- Triggered gate: Oscillation start/stop at  $\uparrow$  or  $\downarrow$ . Select either.
- Minimum pulse width is 50 ns.
- In sweep oscillation mode, the sweep starts at  $\uparrow$  or  $\downarrow$ . Select either.
- Minimum pulse width is 200 ns.

Input voltage : High level  $\geq +3.9$  V  
Low level  $\leq +1.6$  V

Input voltage range :  $-0.5$  to  $+5.5$  V

Input impedance : Pull up to  $+5$  V at approx.  $10$  k $\Omega$

Ground : Connected to chassis ground

**CAUTION**

**Do not apply a signal exceeding the above input voltage range. The unit can be damaged.**

### • Drive circuit examples

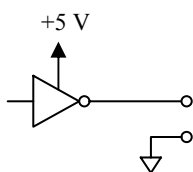

(a) TTL logic output

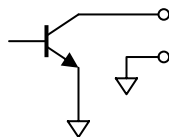

(b) Open collector output

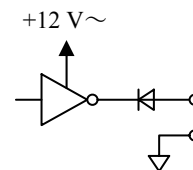

(c) High voltage logic output

Connect the trigger and sweep input drive signals to TTL or C-MOS logic IC outputs.

Since the input circuit is provided with a built-in pullup resistor, an open collector output drive can also be used. However, contact chatter from a mechanical switch or relay can prevent normal operation. Also, chattering will prevent normal operation when the oscillation mode is triggered gate.

Avoid using a logic IC circuit having a power supply voltage higher than  $+5$  V such as example (c) for the WF1945B input

■ Sweep stop/restart input (SWEEP PAUSE IN)

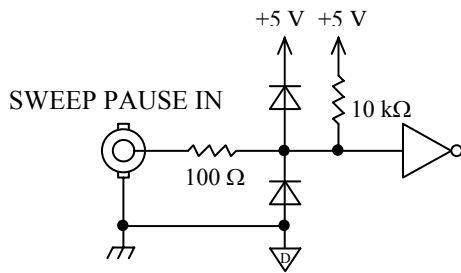

- Signal characteristics : Low level ; sweep pause  
 High level ; sweep restart
- Input voltage : High level  $\geq +3.9$  V  
 Low level  $\leq +1.6$  V
- Input voltage range :  $-0.5$  to  $+5.5$  V
- Input impedance : Pull up to  $+5$  V at approx.  $10$  k $\Omega$
- Ground : Connected to chassis ground

**CAUTION**

Do not apply a signal exceeding the above input voltage range. The unit can be damaged.

■ Sweep X-drive output (SWEEP X-DRIVE OUT)

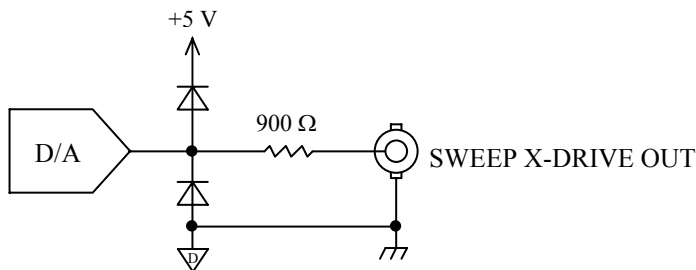

- Signal characteristics : 0 to  $+5$  V ; sweep increase  
 $+5$  to 0 V ; sweep decrease
- Output voltage : 0 to  $+5$  V (open)
- Output impedance : Approx.  $1$  k $\Omega$
- Recommended load : Above  $10$  k $\Omega$
- Ground : Connected to chassis ground

**CAUTION**

Avoid shorting the output or applying an external signal. The unit can be damaged.



### ■ Sweep marker output (SWEEP Z-MARKER OUT)

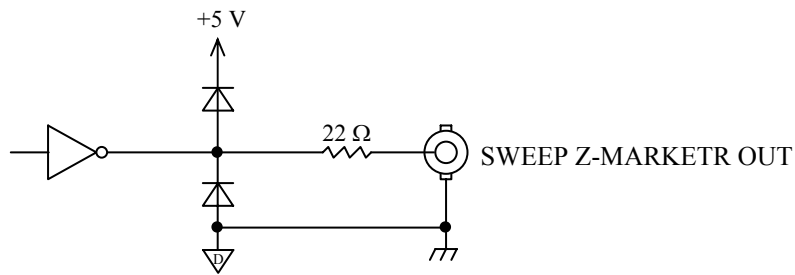

Signal characteristics :	Low level ; sweep greater than marker
	High level ; other times
Output voltage :	TTL level, 0 V/+5 V
Recommended load :	Above 1 kΩ
Ground :	Connected to chassis ground

**CAUTION**

Avoid shorting the output or applying an external signal. The unit can be damaged.

### ■ External add input (EXT ADD IN)

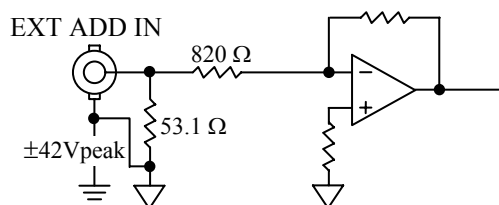

Input voltage :	$\pm 5$ V
Input impedance :	50 $\Omega$
External add frequency :	Up to 10 MHz
Ground :	Connected to signal ground (floating from chassis)

**CAUTION**

Do not apply a signal exceeding the above voltage. The unit can be damaged.

■ External AM input (EXT AM IN)

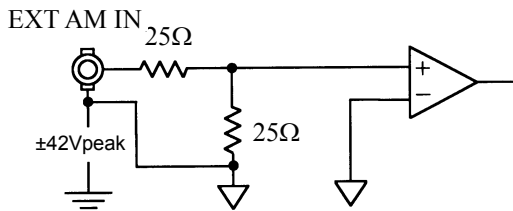

- Input voltage : -3 V to +1 V  
(-100% output at -3 V, 0% output at -1 V, 100% output at +1 V)
- Input impedance : 50 Ω
- Modulation frequency : Up to 10 MHz
- Ground : Connected to signal ground (floating from chassis)



**Do not apply a signal exceeding the above voltage. The unit can be damaged.**

■ Synchronous operation input and output (φ-SYNC IN, OUT)

(Options, 1991 and 1994)

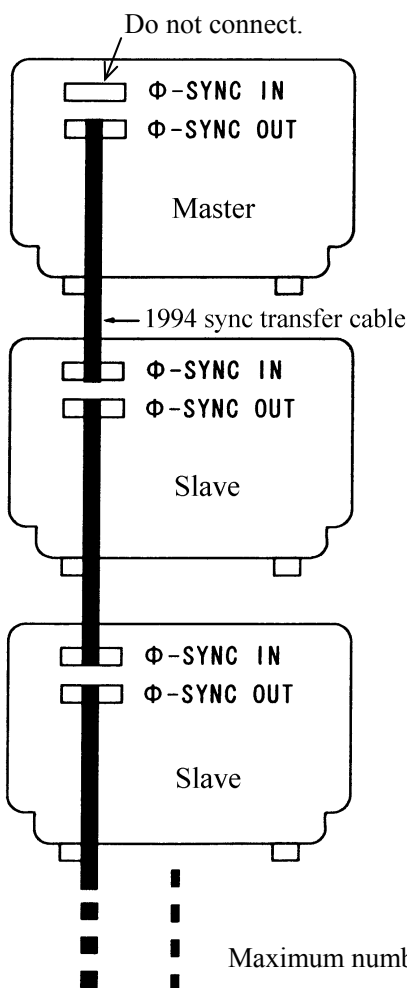

**Note:** Effective during continuous (Normal) oscillation mode.

Timing error: Maximum 35 ns per unit. Thus, phase error of 0.1 degree at approx. 8 kHz and 1 degree at approx. 80 kHz.

Description: The clock is sent from Master to Slave to Slave. The delay per unit is approximately 17 nanoseconds. The clock period is approximately 25 ns. The phase synchronizing pulse can be generated by any of the master or slave units and sent toward the terminal. Delay per unit is approximately 8 ns. Due to the phase difference from this delay time, the error between adjacent units is approximately 25 ns (clock period) + 8 ns (phase sync pulse delay) = 33 ns. The WF1945B, WF1946B, WF1945A, WF1946A, WF1965, WF1966, WF1945 (1945), WF1946 (1946), and WF1956 (1956) equipped with the 1991 can be connected.

Maximum number of connected units: 6

 **CAUTION**

**Note the following for synchronous operation of multiple products:**

- **Switch off all products before connecting or disconnecting sync transfer cables.**
- **Switch on all products that are connected by the sync transfer cables and that will be used. Disconnect the sync transfer cable from any product that will not be used.**
- **If possible, simultaneously switch on all products that are connected by the sync transfer cables.**  
**If simultaneous switch-on is not possible, switch on products in succession from the master (primary) side to the slave (secondary, tertiary) side.**
- **If possible, simultaneously switch off all products that are connected by the sync transfer cables.**  
**If simultaneous switch-off is not possible, switch off products in succession from the slave (secondary, tertiary) side to the master (primary) side.**

■ Digital output (DIGITAL OUT) (1992A: option) ⚠

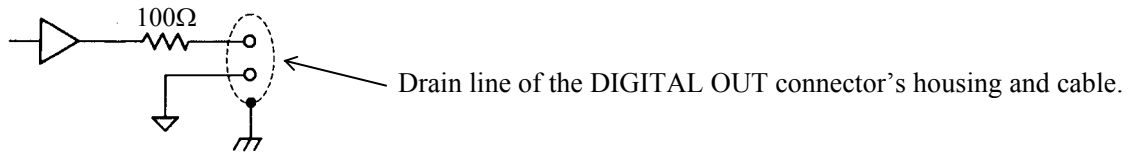

- Output impedance :    Approx. 115 Ω
- Output voltage :     0 V/+5 V (open)
- Connections :        See table
- Ground :             Signal GND lines connected to signal ground (floating from chassis)  
                          Drain line connected to chassis ground

Connect GND to all target signal grounds.    Lease unused signal lines open.

When the drain line is connected to the target signal ground, the WF1945B signal grounds (FUNCTION OUT, SYNC OUT, EXT ADD IN, EXT AM IN) are grounded to chassis.

The accessory cable signals are indicated by marking quantity and color, and insulation color.

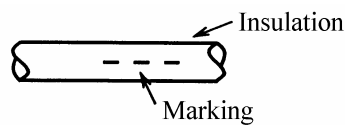

Signal	Connec-tion	Mark color	Mark quantity	Insulation color
Output control	Signal	Red	3	White
	GND	Black		
D15 (MSB)	Signal	Red	2	Orange
	GND	Black		
D14	Signal	Red	3	Yellow
	GND	Black		
D13	Signal	Red	1	Pink
	GND	Black		
D12	Signal	Red	2	Pink
	GND	Black		
D11	Signal	Red	2	Yellow
	GND	Black		
D10	Signal	Red	3	Pink
	GND	Black		
D09	Signal	Red	1	Yellow
	GND	Black		
D08	Signal	Red	3	Orange
	GND	Black		

Signal	Connec-tion	Mark color	Mark quantity	Insulation color
D07	Signal	Red	2	White
	GND	Black		
D06	Signal	Red	4	Orange
	GND	Black		
D05	Signal	Red	1	White
	GND	Black		
D04	Signal	Red	3	gray
	GND	Black		
D03	Signal	Red	2	gray
	GND	Black		
D02	Signal	Red	4	gray
	GND	Black		
D01 (LSB)	Signal	Red	1	gray
	GND	Black		
Clock	Signal	Red	4	White
	GND	Black		
Not used	Signal	Red	1	Orange
	GND	Black		
Chassis ground		Drain line		

- The output control line is pulled up to +5 V at approx. 10 kΩ.    When this line is low level, the clock and D01 to D15 output signals are on.    When open, the output signals are high impedance.



**Avoid shorting the output or applying an external signal. The unit can be damaged.**

• **Accessory cable connection example 1**

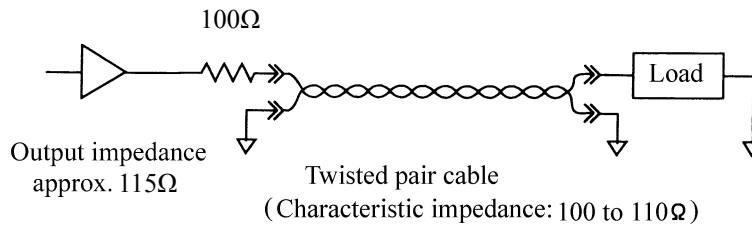

Since the sending impedance and transmission line characteristic impedance is nearly matching, a comparatively good waveform can be obtained even with an open load.

• **Accessory cable connection example 2**

Even better waveform quality can be obtained by terminating at 110 to 120 Ω. In this case, the amplitude at the load end is about 1/2 that at the output end.

This response can be utilized to apply a suitable voltage to even a low operating voltage CMOS. But in this case, do not set to high impedance with the output control line. Circuit damage can occur with a CMOS device.

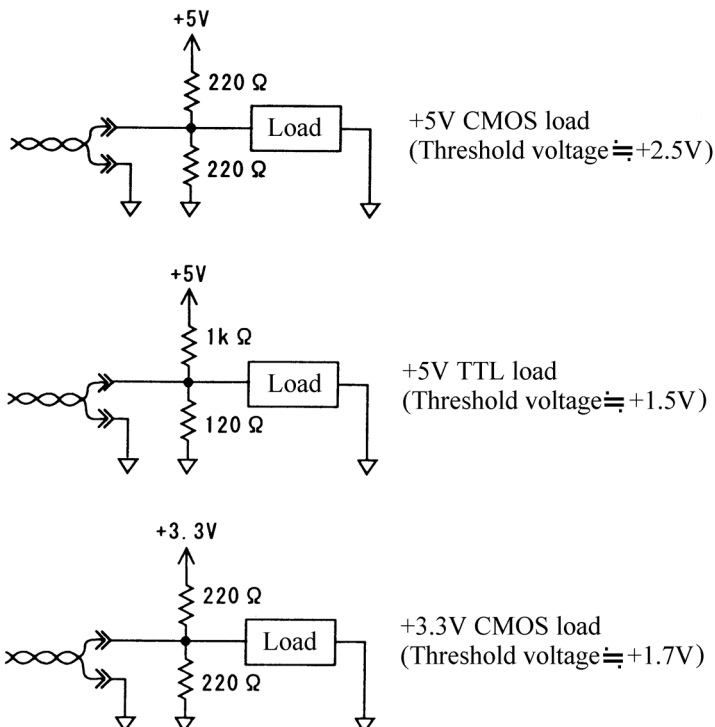

- Digital output is undefined when the oscillation mode is NOISE or DC.
- Except for the following cases, data corresponding to the waveform (FUNCTION) is output as digital output:

□ (duty 50% fixed): Data corresponding to is output.

□ (variable duty): Data to be output is undefined.

## 3.3 Basic operation

Basic operation is described using an example of a triangular waveform with frequency 1 kHz, amplitude 2 V<sub>p-p</sub> and DC offset +1 V from the waveform output connector.

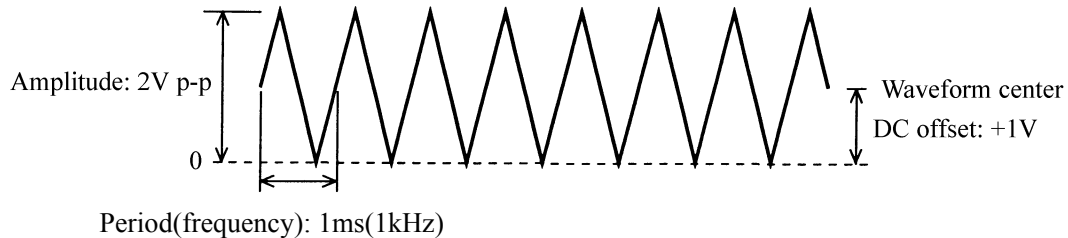

### ■ Setting initialize(PRESET)

The operation of initializing all settings is described. This instruction manual presumes operation directly after initializing.

#### Operation:

- ① Press the  key, then use the  and  keys to produce the following display. (lower PRESET flashes).

```
PRESET
SYSTEM: RANGE PRESET USER-UNIT ▶
```

- ② Press the  key (upper PRESET flashes).
- ③ Again press the  key to initialize. To return without initializing, before pressing , press the  key twice.

**Initialized settings :**

Initialized settings are indicated in the table.

Settings related to output on/off, output on/off at power on, arbitrary waveform, setting memory, user units , remote control, GPIB address, GPIB delimiter, and USB ID are not initialized.





Initialization table

Key operation	Menu	Initial settings	Remarks
MODE		NORMAL	
MODE→BURST	TYPE	BURST	
	SOURCE	EXT $\nabla$ (1 ms, at INT)	When TYPE=TRIG, GATE,T-GATE
	DELAY	0.3 $\mu$ s	When TYPE=TRIG
	MARK	1.0	When TYPE=BURST, TRIG
	SPACE	1.0	When TYPE=BURST
	STOP-LEVEL	OFF (0 %, at ON).	
MODE→SWEEP	TYPE	FREQ	
	SOURCE	EXT $\nabla$ (1 ms at INT)	When MODE=SINGLE, GATED
	MODE	SINGLE	
	FUNCTION	LIN $\nearrow$	
	TIME	1 s	
	STOP-LEVEL	OFF (0%, at ON).	When MODE=GATED
MODE → SWEEP, TYPE=FREQ	START	1000 Hz	
	STOP	10000 Hz	
	CENTER	5500 Hz	
	SPAN	9000 Hz	
	MARKER	5000 Hz	
MODE → SWEEP, TYPE=AMPTD	START	0.1 Vp-p	
	STOP	1 Vp-p	
	CENTER	0.55 Vp-p	
	SPAN	0.9 Vp-p	
	MARKER	0.5 Vp-p	
MODE → SWEEP, TYPE=OFFSET	START	0.1 V	
	STOP	-0.1 V	
	CENTER	0 V	
	SPAN	0.2 V	
	MARKER	0 V	
MODE → SWEEP, TYPE=PHASE	START	-90 deg	
	STOP	90 deg	
	CENTER	0 deg	
	SPAN	180 deg	
	MARKER	0 deg	
MODE → SWEEP, TYPE=DUTY	START	40 %	
	STOP	60 %	
	CENTER	50 %	
	SPAN	20 %	
	MARKER	50 %	

Continued next page

### 3.3 Basic operation

Continued from previous page

Key operation	Menu	Initial settings	Remarks
MODE→MODU	TYPE	FM	
	FREQUENCY	100 Hz	
	FUNCTION		
MODE → MODU, TYPE=FM	DEVIATION	1000 Hz	
MODE → MODU, TYPE=AM	DEPTH	50 %	
MODE → MODU, TYPE=OFSM	DEVIATION	0.2 V	
MODE → MODU, TYPE=PM	DEVIATION	90 deg	
MODE → MODU, TYPE=PWM	DEVIATION	20 %	
ENTRY→FREQ		1000 Hz	
ENTRY→AMPTD		0.1 Vp-p	
ENTRY→OFFSET		0 V	
ENTRY→PHASE		0 deg	
ENTRY→WIDTH		0.0005 s	In case of FUNCTION= 
ENTRY→DUTY		50 %	In case of FUNCTION= 
ENTRY→PERIOD		0.001 s	
ENTRY→HIGH		0.05 V	
ENTRY→LOW		-0.05 V	
FUNCTION			
SYSTEM	RANGE	AUTO	
	LOAD	OPEN (50 ohms at SET)	
	EXT-AM	OFF	
	EXT-ADD	OFF	
	DUTY-VALID	IMMED	
	SYNC-OUT	STATE	



## ■ Oscillation mode selection ( <sup>MODE</sup> )

Oscillation mode (continuous, burst, sweep, etc.) selection is described.

### Terms:

NORMAL (continuous):	Continuous oscillation; normally use this mode.
BURST :	Intermittent oscillation (BURST, TRIG, GATE, T-GATE) ☞ “4.1 Burst oscillation”, cf.
SWEEP :	Item such as frequency is automatically varied. ☞ “4.2 Sweep”, cf.
MODU (modulation) :	Modulated waveform output (FM, AM, OFSM, PM, PWM) ☞ “4.3 Modulation”, cf.
NOISE :	White noise output
DC :	DC output

### Operation:

The selected oscillation mode is indicated in the STATUS area, which is located to the left of <sup>MODE</sup> key. When the <sup>MODE</sup> key is pressed, the <sup>MODE</sup> key lamp lights, and at the same time, the lamp of every key located to the right of the <sup>MODE</sup> key lights.

To use another oscillation mode (one whose key lamp is already lit), press the key of the mode.

### Operation example:

In this example, first set to DC, then to continuous (NORMAL).

- ① Press the <sup>MODE</sup> key, then the <sup>DC</sup> key to set the DC mode.

The <sup>DC</sup> STATUS lamp lights.







- ② Press the <sup>MODE</sup> key, then the <sup>NORMAL</sup> key to set the NORMAL mode.

The <sup>NORMAL</sup> STATUS lamp lights.





■ **Waveform selection** (  )

Waveform selection is described.

**Symbols:**



-  : Sinewave
-  : Triangular wave
-  : Squarewave (50 % fixed duty)
-  : Squarewave (variable duty)
-  : Rising sawtooth
-  : Descending sawtooth
- ARB: Arbitrary waveform  
 "4.4 Arbitrary Waveform (ARB)", cf.

**Operation:**

The selected waveform is indicated in the STATUS area, which is located to the left of  key. When the  key is pressed, the  key lamp lights, and at the same time, the lamp of every key located to the right of the  key lights. The lamp of the selected waveform blinks. To select another waveform (one whose key lamp is already lit), press the key of the waveform.

**Operation example:**

In this example, a triangular waveform is selected.

- ① Press the  key, then the  key.

The  STATUS lamp lights



- ② After selecting, press the  key once to exit the setting mode.

**Other:**

In  squarewaves (variable duty), pulses may disappear depending on the relations between the cycle and duty when the pulse width falls below 25 ns. For such settings, an error message is displayed.

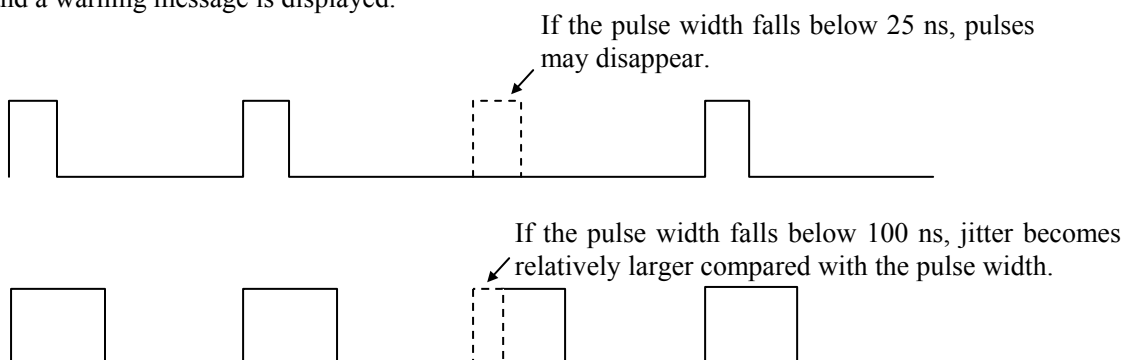
When the pulse width is 100 ns or less, jitter becomes relatively larger compared with the pulse width, and a warning message is displayed.



If the phase of the  squarewaves (fixed duty) or  squarewaves (variable duty) is changed, multiple pulses may be output in one cycle, as shown below.

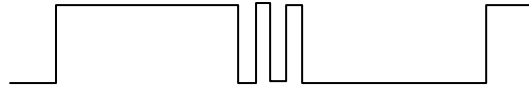

If the duty of the  squarewaves (variable duty) is changed, multiple pulses may be output in one cycle, as shown below.

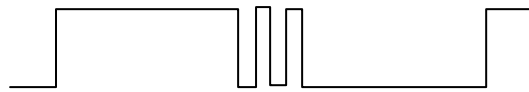

If the pulse width is larger than 75 ns after the duty is changed, it is possible to suppress the output of multiple pulses in one cycle. Therefore, set DUTY-VALID to CYCLE.

Note, however, that this setting cannot be made if the oscillation mode is SWEEP or MODU.



If DUTY-VALID is set to CYCLE, the set duty will be reflected in the subsequent cycles.

Even though DUTY-VALID is set to CYCLE, extra pulses may be output if the frequency or phase is changed.

Operation when DUTY-VALID: IMMED

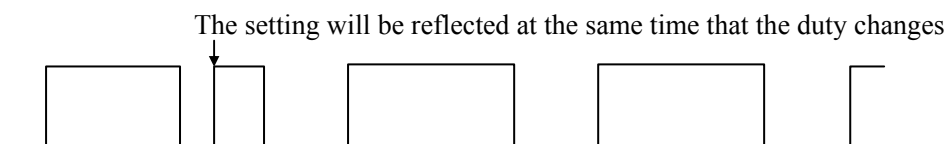

Operation when DUTY-VALID: CYCLE

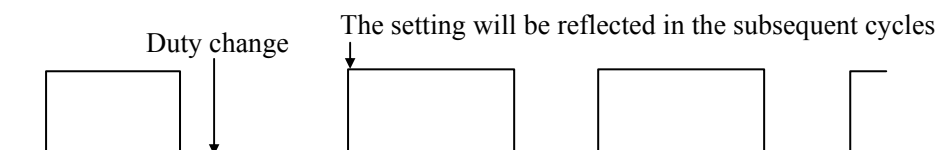

- In  squarewaves (variable duty), the duty range can be switched to 0.0000% to 100.0000% or 0.0100% to 99.9900%. To set a duty in the range from 0.0000% to 100.0000%, set DUTY-VALID to EXPAND.



It is not possible to set CYCLE and EXPAND simultaneously.

If DUTY-VALID is set to IMMEDIATE or CYCLE, the range in which the duty can be set is 0.0100% to 99.9900%. When the frequency is about 4 kHz or less, pulse losses can be prevented by restricting the duty range to 0.0100% to 99.9900%.

The waveform cannot be selected in the following cases.

- Oscillation mode is NOISE or DC.
- TYPE is DUTY in SWEEP oscillation mode.
- TYPE is PWM in MODU oscillation mode.

## ■ Frequency setting ( → )

Frequency (FREQ) setting is described.

### Operation:

Two methods can be used for setting the frequency.

#### (1) Keypad

This method is convenient when the frequency has been determined beforehand.

For example, set 1 kHz as follows.

- ① Press the  key, then the  key.

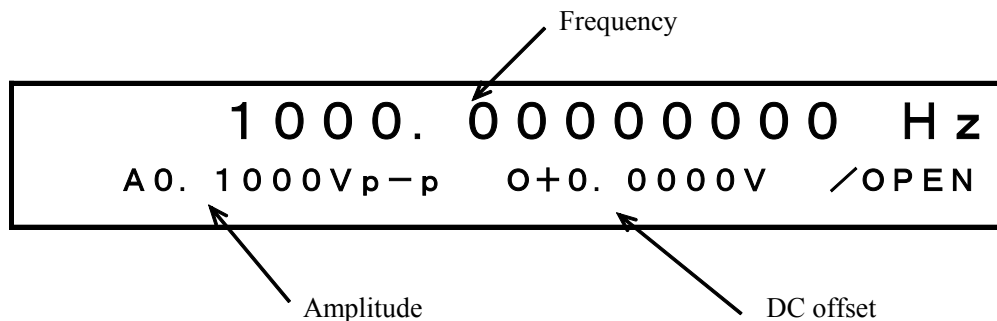

- ② Press the  key, then the  key.

If the number was entered incorrectly, press the  key before pressing the  key.

- ③ After setting, press the  key to exit the setting mode.

#### (2) Modify dial

This is convenient for continuously setting the frequency.

- ① Press the  key, then the  key.
- ② Select the digit to be changed with the  and  keys. The selected digit flashes.
- ③ Turn the  dial to set the digit.
- ④ After setting, press the  key.

### Other:

- The frequency cannot be set in the **NOISE** or **DC** oscillation modes.
- When keys such as  are not being used for industrial units (e.g., 50 Hz), press the  key directly after entering the frequency. "5.2 Units", cf.
- The frequency generating period can also be set. "5.1 Convenient Settings (■Frequency [Hz] setting by period [s])", cf.

## ■ Amplitude setting ( → )

Amplitude (AMPTD) setting is described.

### Operation:

The amplitude can be set by two methods.

#### (1) Keypad

Convenient when the amplitude has been determined beforehand.

For example, set 2 Vp-p as follows.

- ① Press the  key, then the  key.

The following display is produced.

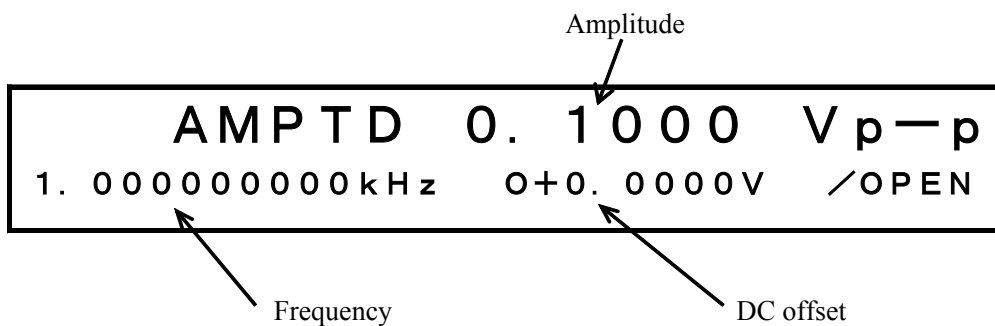

- ② Press the  key, then the  key.  
 To correct an entry, press the  key before pressing  key.
- ③ This completes setting, afterwards, press the  key.

#### (2) Modify dial

The amplitude can be changed continuously.

- ① Press the  key, then the  key.
- ② Select the digit to be changed with the  and  keys.
- ③ Turn the  dial to set the flashing digit.
- ④ After setting, press the  key to release the setting mode.

### Other:

- When the oscillation mode is DC, the amplitude cannot be set.
- Units other than Vp-p can also be set. "5.2 Units", cf.
- Can also be set by waveform high level and low level.  
 "5.1 Convenient Settings (■Amplitude and DC offset setting by high and low level)", cf.

## ■ DC offset setting ( → )

DC offset determines the offset component added to the waveform or the output voltage when the oscillation mode is DC.

Setting the DC offset (OFFSET) is described.

### Operation:

Two methods can be used for setting the DC offset.

#### (1) Keypad

Convenient when the DC offset has been determined beforehand.

For example, set +1 V as follows.

- ① Press the  key, then the  key.

The following display is produced.

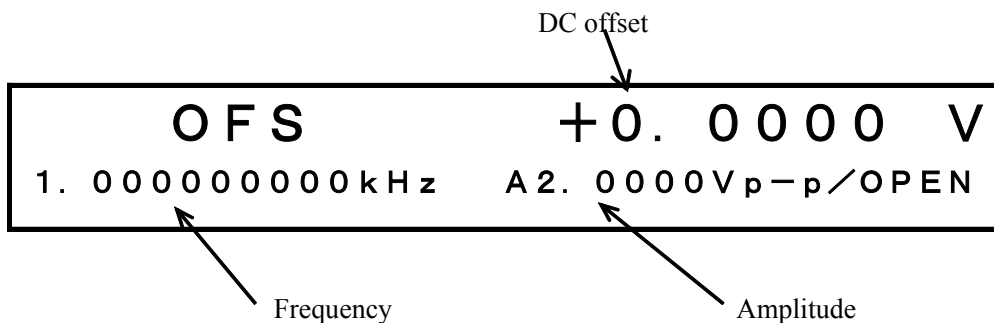

- ② Press the  key, then the  key.  
 To correct an entry, press the  key before pressing .
- ③ This completes setting, afterwards, press the  key.

#### (2) Modify dial

The offset can be changed continuously.

- ① Press the  key, then the  key.
- ② Select the digit to be changed with the  and  keys.
- ③ Turn the  dial to set the flashing digit.
- ④ After setting, press the  key to release the setting mode.

### Other:

- Can also be set by waveform high level and low level.

“5.1 Convenient Settings (■ Amplitude and DC offset setting by high and low level)”, cf.

■ **Phase setting** (  →  )

The oscillation starting phase setting for burst and (gated) sweep is described.

**Operation:**

Two methods can be used for setting the phase.

**(1) Keypad**

Convenient when the phase has been determined beforehand.

For example, set 90 degrees as follows.

- ① Press the  key, then the  key.

The following display is produced.

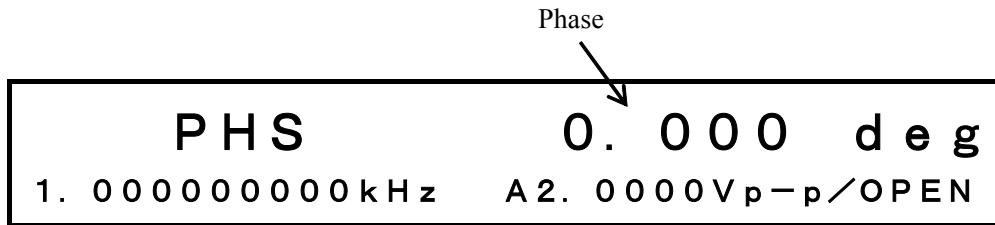

Frequency

Amplitude

- ② Press keys  and , then the  key.  
 To correct an entry, press the  key before pressing .
- ③ This completes setting, afterwards, press the  key.

**(2) Modify dial**

The phase can be changed continuously.

- ① Press the  key, then the  key.
- ② Select the digit to be changed with the  and  keys.
- ③ Turn the  dial to set the flashing digit.
- ④ After setting, press the  key to release the setting mode.



## ■ Output on/off

Output on/off setting is described.

### Operation:

- ① Press the  key. The setting alternates between on and off each time the key is pressed.

The lamp lights when on, extinguishes when off.

### ■ Operation tree

OUTPUT  
ON/OFF — Output on/off

MODE — Oscillation mode  
└─ NORMAL / BURST / SWEEP / MODU / NOISE / DC

BURST Menu  
├─ TYPE (Burst type) [BURST/TRIG/GATE/T-GATE]  
├─ SOURCE (Trigger/gate source selection)  
├─ DELAY (Trigger delay) \* For TYPE: TRIG  
├─ MARK (Number of cycles signal present) \* For TYPE: BURST/TRIG  
├─ SPACE (Number of cycles signal not present) \* For TYPE: BURST  
└─ STOP-LEVEL (Stop level)  
\* When the same TYPE is set for both channels

BURST Operation  
└─ MAN TRIG

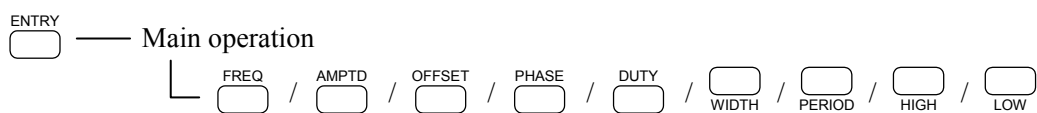
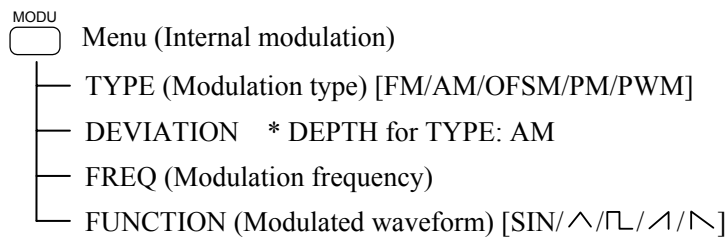
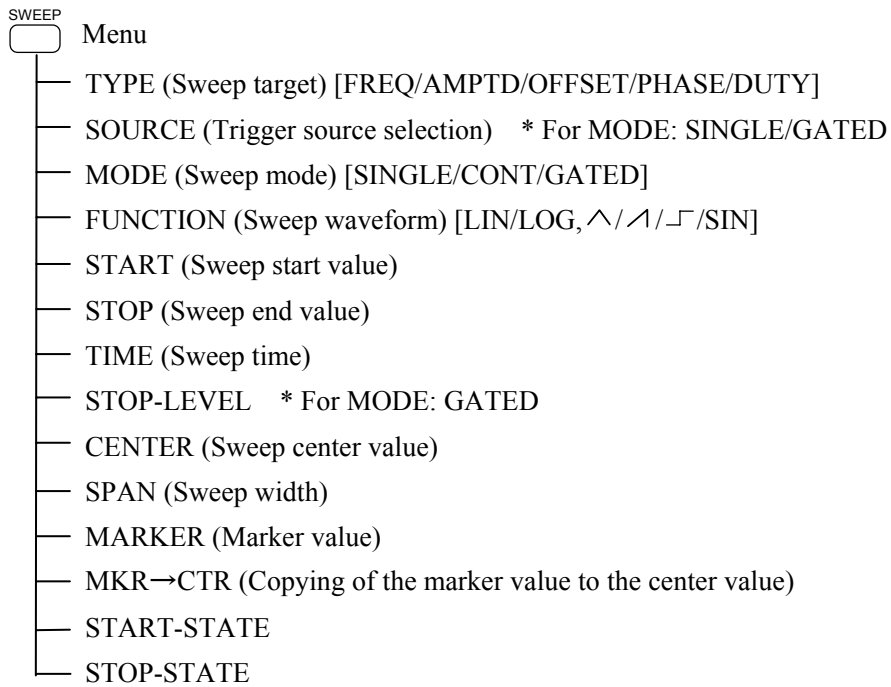

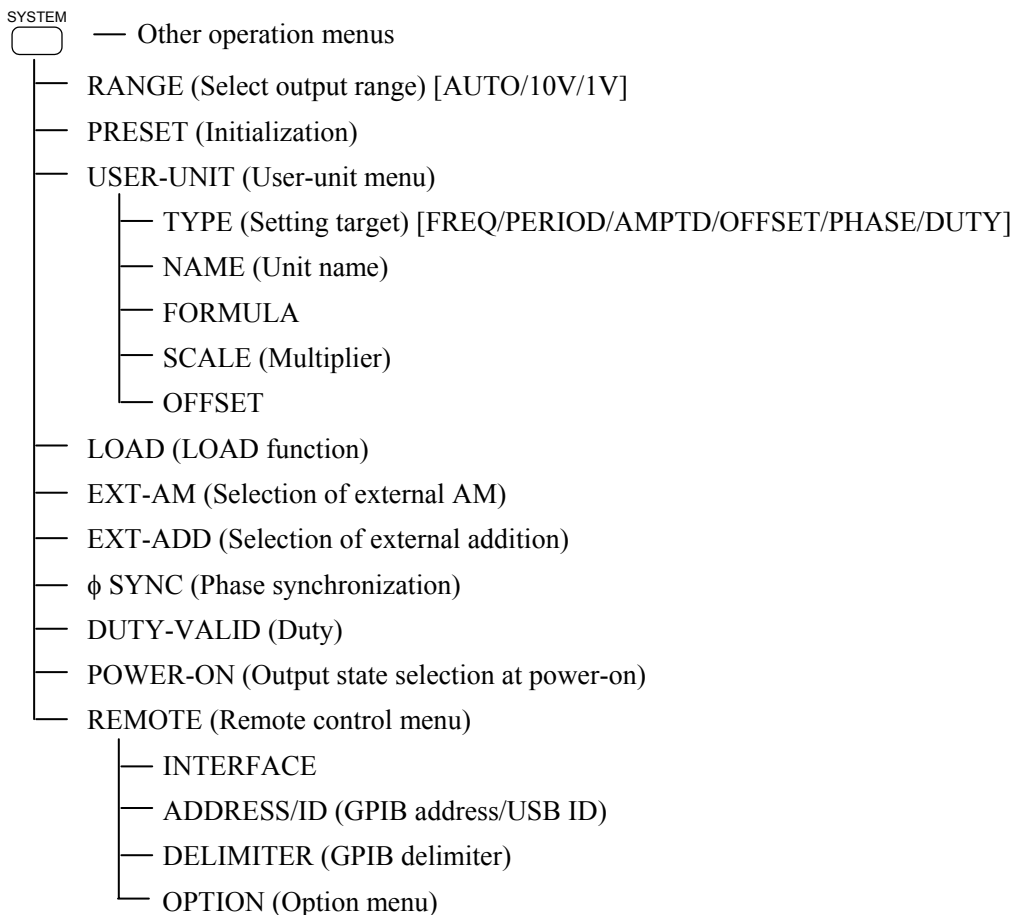
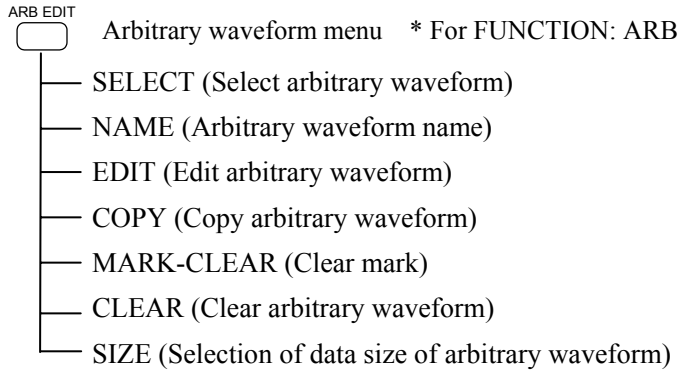

\* DUTY/WIDTH for FUNCTION:





 Setup memory menu

- STORE (Save setup memory)
- RECALL (Call setup memory)
- CLEAR (Clear setup memory)











 (Release remote state)







 (Cancel setting)

 (Move to menu immediately above)

 (Accept input value)

Numeric input (keypad)

 /  /  /  /  /  /  /  /  /  /

 /  /  /  /  /  / 

Numeric modification (Modify)

 /  / 



## Section 4 Applications

4.1	Burst oscillation .....	4-2
	■ Burst oscillation (Type: Burst) .....	4-2
	■ Burst oscillation (Type: Trigger) .....	4-5
	■ Burst oscillation (Type: Gate) .....	4-9
	■ Burst oscillation (Type: Triggered Gate) .....	4-13
4.2	Sweep .....	4-16
	■ Sweep (Mode: Single) .....	4-16
	■ Sweep (Mode: Continuous) .....	4-22
	■ Sweep (Mode: Gated) .....	4-27
	■ CENTER, SPAN, MARKER, MKR → CTR .....	4-34
	■ Summary of the sweep setting items .....	4-35
	■ Sweep (modulation) steps and step width .....	4-36
	■ Sweep value and Z-MARKER/SYNC/X-DRIVE outputs .....	4-38
4.3	Modulation .....	4-40
	■ Frequency modulation (FM) .....	4-40
	■ Amplitude modulation (AM) .....	4-43
	■ DC offset modulation (OFSM) .....	4-46
	■ Phase modulation (PM) .....	4-49
	■ Pulse width modulation (PWM) .....	4-52
4.4	Arbitrary Waveform .....	4-55
	■ Arbitrary waveform (ARB) .....	4-55
4.5	Selecting waveforms of synchronous signals (SYNC OUT) .....	4-60
	■ Procedure .....	4-60
	■ When the oscillation mode is BURST .....	4-60
	■ When the oscillation mode is SWEEP .....	4-61
	■ When the oscillation mode is MODU .....	4-61
	■ Additional information: .....	4-62
4.6	Output waveforms for sweeping and modulation .....	4-63
4.7	Equivalent noise bandwidth .....	4-65

• Following is an example of the display when using this section.

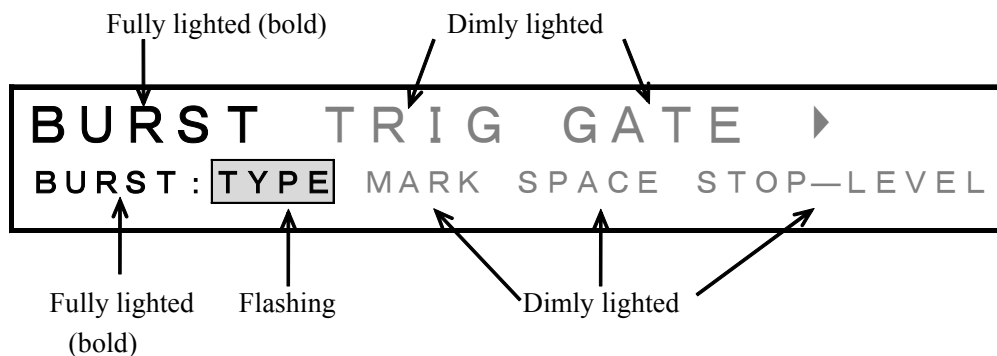

## 4.1 Burst oscillation

### ■ Burst oscillation (Type: Burst) ( <sup>MODE</sup> → <sup>BURST</sup> → TYPE : BURST)

Burst oscillation (Type: Burst) produces an intermittent oscillation at the designated oscillation cycle and stop cycle.

Operation is described with reference to an example of producing a waveform output such as indicated in the figure.

In this example, the waveform is triangular, the DC offset is set to 0 V, the oscillation start phase is set to 0 degrees, and the frequency and amplitude are set to arbitrarily defined values.

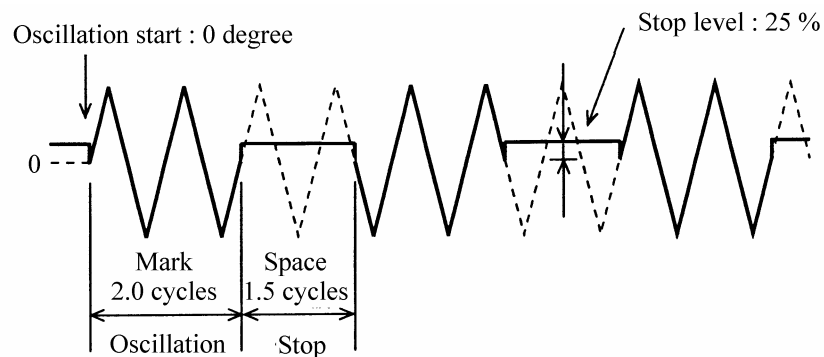

#### Operation:

(1) Set the burst oscillation TYPE to BURST.

- ① Press the <sup>MODE</sup> key, then the <sup>BURST</sup> key.
- ② Use the  and  keys to select the type (TYPE flashes).

```

BURST TRIG GATE ▶
BURST : TYPE MARK SPACE STOP-LEVEL
    
```

- ③ Press the <sup>ENTER</sup> key, then produce the following display with the  and  keys (BURST flashes).



```

BURST TRIG GATE ▶
BURST : TYPE MARK SPACE STOP-LEVEL
    
```

- ④ This sets the burst oscillation type to burst. Press the <sup>EXIT</sup> key once to exit type setting.





**(2) Set MARK cycle**

- ① Use the  and  keys to produce the following display (MARK flashes).

```

1.0 cycle
BURST : TYPE MARK SPACE STOP-LEVEL



```

- ② Press the  key.
- ③ Set the mark cycles with the keypad or  dial (0.5 cycles).

In this example, the setting is 2.0 cycles.

- ④ After setting, press the  key once to exit mark cycle setting.



**(3) Set SPACE cycle**

- ① Use the  and  keys to produce the following display (SPACE flashes)



```

1.0 cycle
BURST : TYPE MARK SPACE STOP-LEVEL

```

- ② Press the  key.
- ③ Set the space cycles with the keypad or  dial (0.5 cycles). In this example, the setting is 1.5 cycles.
- ④ After setting, press  once to exit space cycle setting.



**(4) Set STOP-LEVEL**

- ① Use the  and  keys to produce the following display (STOP-LEVEL flashes).



```

OFF
BURST : TYPE MARK SPACE STOP-LEVEL

```

- ② Press the  key.  
Turn the  dial to produce the following display (ON flashes).





- ③ Press the  key, then set the stop level with the keypad or  dial.  
In this example, the setting is 25 %.

The stop level is the percentage with respect to the maximum positive (+100 %) and negative (-100 %) amplitude.

- ④ After setting, press the  key to release the setting mode.

This completes burst oscillation (type: burst) setting.

**Other:**

- If the frequency exceeds 5 MHz, mark cycles and space cycles may be unpredictable. If the cycles are undefined, the start phase may be shifted by half a cycle even though the frequency is set to less than 5 MHz. If such a shift occurs, set the continuous oscillation and then the burst oscillation.
- Stop level off: Oscillation stops at the phase (set by  →  ) setting (mark cycles more than 1.0 and mark + space cycles are integers).

Waveform example of oscillation start phase:-90°, mark waves:2, space waves:1

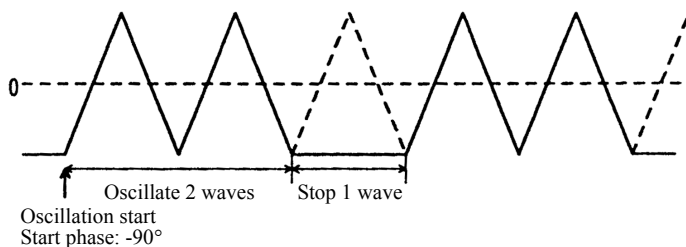

\*Also, by setting an amplitude ( $V_{p-p}$ ) 1/2 DC offset or the low level to 0 V, a unipolar waveform can be obtained.

 “5.1 Convenient Settings (■Amplitude and DC offset setting by high and low level)”, cf.

- Burst oscillation setting items (BURST menu)
  - TYPE: BURST
  - MARK (oscillation cycle) [cycle]
  - SPACE (cycle when oscillation stops) [cycle]
  - STOP-LEVEL [OFF, ON[%]]
  - PHASE (phase when oscillation starts) [deg] \* ENTRY menu

■ **Burst oscillation (Type: Trigger)** ( <sup>MODE</sup> → <sup>BURST</sup> → **TYPE : TRIG**)

Burst oscillation (Type: Trigger) produces an intermittent oscillation output at a designated cycle at each trigger signal.

Operation is described with reference to an example of producing a waveform output such as indicated in the figure in response to an external trigger (  ).

The example is a triangular waveform, DC offset 0 V, frequency and amplitude arbitrary.

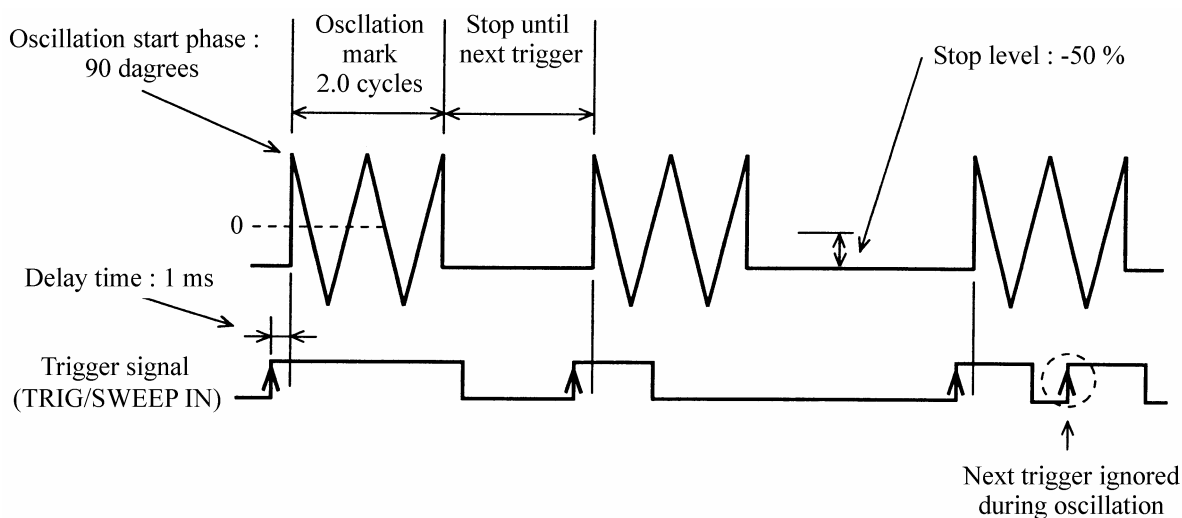

**Operation:**

(1) Set the burst oscillation **TYPE** to **TRIG**.

- ① Press the <sup>MODE</sup> key, then the <sup>BURST</sup> key.
- ② Use the  and  keys to select the type (TYPE flashes).

```

BURST TRIG GATE ▶
BURST : TYPE MARK SPACE STOP-LEVEL
  
```



- ③ Press the <sup>ENTER</sup> key, then produce the following display with the  and  keys (TRIG flashes).

```





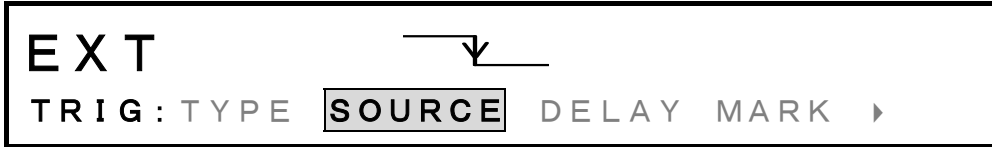

BURST TRIG GATE ▶
TRIG : TYPE SOURCE DELAY MARK ▶
  
```

- ④ This sets the burst oscillation type to trigger. Press the <sup>EXIT</sup> key to exit type setting.



**(2) Select trigger SOURCE**

- ① Use the  and  keys to produce the following display (SOURCE flashes).





- ② Press the  key.
- ③ Press the  key, then turn the  dial to select rising trigger ().  
( indicates falling trigger).
- ④ After setting, press  once to release trigger source setting.



**(3) Set DELAY time**

- ① Use the  and  keys to produce the following display (DELAY flashes).





- ② Press the  key.
- ③ Set the delay time with the keypad or  dial.  
For example, set to 1 ms.
- ④ After setting, press  once to release delay time setting.



**(4) Set MARK cycle**

- ① Use the  and  keys to produce the following display (MARK flashes).





- ② Press the  key.  
Set the mark cycles with the keypad or  dial (0.5 cycles).  
In this example, the setting is 2.0 cycles.
- ③ After setting, press  once to release mark cycle setting.



**(5) Set STOP-LEVEL**

- ① Use the  and  keys to produce the following display (STOP-LEVEL flashes).



- ② Press the  key.  
Turn the  dial to produce the following display (ON flashes).



- ③ Press the  key, then set the stop level with the keypad or  dial.  
In this example, the setting is -50 %.

The stop level is the percentage with respect to the maximum positive (+100 %) and negative (-100 %) amplitude.

- ④ After setting, press the  key to release the setting mode.

**(6) Phase setting**

- ① Press the  key, then the  key
- ② Set the phase with the keypad or  dial.

For example, set the phase to 90 degrees.



- ③ After setting, press the  key to release the setting mode.

The above sets burst oscillation (Type: Trigger). Oscillation is produced when a signal () is applied to the TRIG/SWEEP IN connector.

**Additional information:**

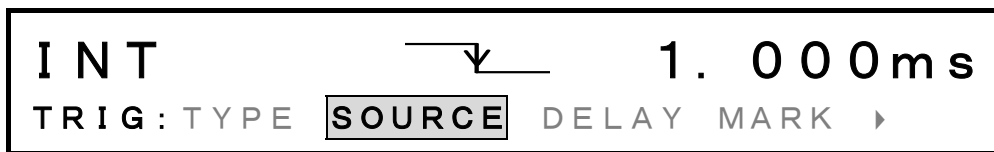
- **Internal trigger:** The trigger signal is produced at the rate indicated below for oscillation start/stop.



- **Stop level off** : Oscillation stops at the phase (set by  →  ) setting (mark cycle is integer).
- **Manual trigger** : Press the  key, then set the trigger source to EXT . Operation is based on the logical OR of the external signal, key, and type of remote control (GPIB or USB).
- **To generate the trigger signal via remote control (GPIB or USB)**, set the GET command or TRG command from the remote control interface.  
Also, set the trigger source to EXT .

For details of the remote control command,  “Remote Control Instruction Manual”, cf.

- Burst oscillation (Type: Trigger) setting items (BURST menu)

TYPE: TRIG

SOURCE (trigger source) [EXT  $\nabla$ , EXT  $\blacktriangledown$ , INT [s]]

DELAY (trigger delay) [s]

MARK (oscillation cycle) [cycle]

STOP-LEVEL [OFF, ON[%]]

PHASE (phase when oscillation starts) [deg] \* ENTRY menu

### ■ Burst oscillation (Type: Gate) ( MODE → BURST → TYPE : GATE)

Burst oscillation (Type: Gate) is intermittent with start and stop according to the trigger signal level.

Operation is described with reference to an example of producing a waveform output such as indicated in the figure in response to an external gate signal.

The example is a triangular waveform, DC offset 0 V, oscillation start phase 0 degrees, frequency and amplitude arbitrary.

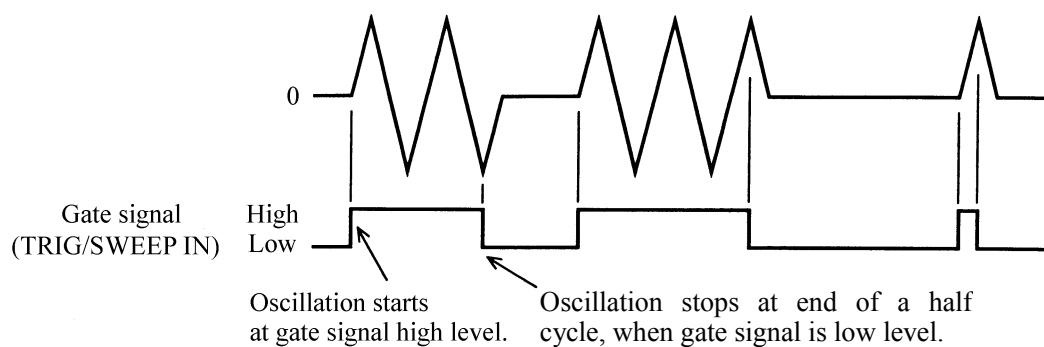

**Operation:**

**(1) Set burst oscillation TYPE to GATE.**

- ① Press the <sup>MODE</sup>  key, then the <sup>BURST</sup>  key.
- ② Use the  and  keys to produce the following display (TYPE flashes).



- ③ Press the <sup>ENTER</sup>  key, then produce the following display with the  and  keys (GATE flashes).



- ④ This sets the burst oscillation type for gate.  
Press the <sup>EXIT</sup>  key once to release the type setting mode.

**(2) Select gate SOURCE**



- ① Use the  and  keys to produce the following display (SOURCE flashes).



- ② Press the <sup>ENTER</sup>  key.
- ③ Press the  key, then select positive logic (H-ON) with the <sup>MODIFY</sup>  dial.
- ④ After setting, press the <sup>EXIT</sup>  key to release the setting mode.





**(3) Set STOP-LEVEL**

- ① Use the  and  keys to produce the following display (STOP-LEVEL flashes).

```



OFF
GATE:TYPE SOURCE STOP-LEVEL
  
```

- ② Press the  key.

Turn the  dial to produce the following display (ON flashes).

```

ON 0.00%
GATE:TYPE SOURCE STOP-LEVEL
  
```

- ③ Press the  key, then set the stop level with the keypad or  dial.

In this example, the setting is 0 %.

The stop level is the percentage with respect to the maximum positive (+100 %) and negative (-100 %) amplitude.

- ④ After setting, press the  key to release the setting mode.

The above selects sets burst oscillation (type: gate). Oscillation occurs when a high level signal is applied to the TRIG/SWEEP IN connector. If the connection is open, oscillation continues due to internal pullup.

**Other settings:**

- At the above settings, when the waveform is squarewave, a three squarewave is obtained such as shown in the following figure.







(When stop level is off, the oscillation stops at either high or low level.)

- **Internal gate source** : A 50 % duty gate signal is generated at the following period for oscillation start/stop.

```

INT H-ON 1.000ms
GATE:TYPE SOURCE STOP-LEVEL
  
```

↙

- **Stop level off** : Oscillation stops at the half-cycle after gate signal off (i.e., at the phase set by  →  ).
- **Manual gate signal** : Press the  key. The gate signal is on (i.e., oscillation) while the key is pressed. In this case, set the trigger source for EXT L-ON.
- **To generate the trigger signal via remote control (GPIB or USB)**, set the GET command or TRG command from the remote control interface.  
Also, set the trigger source to EXT L-ON.  
For details of the remote control command,  “Remote Control Instruction Manual”, cf.
- Burst oscillation (type: gate) setting items (BURST menu)  
TYPE: GATE  
SOURCE (trigger source) [EXT L-ON, EXT H-ON, INT [s]]  
STOP-LEVEL [OFF, ON [%]]  
PHASE (phase when oscillation starts) [deg] \* ENTRY menu

■ **Burst oscillation (Type: Triggered Gate)** ( <sup>MODE</sup> → <sup>BURST</sup> → **TYPE : T-GATE**)

Burst oscillation (Type: Triggered Gate) is intermittent with repeated start and stop at each trigger signal.

Operation is described with reference to an example of producing a waveform output such as indicated in the figure in response to an external trigger () .

The example is a triangular waveform, DC offset 0 V, oscillation start phase 0 degrees, frequency and amplitude arbitrary.

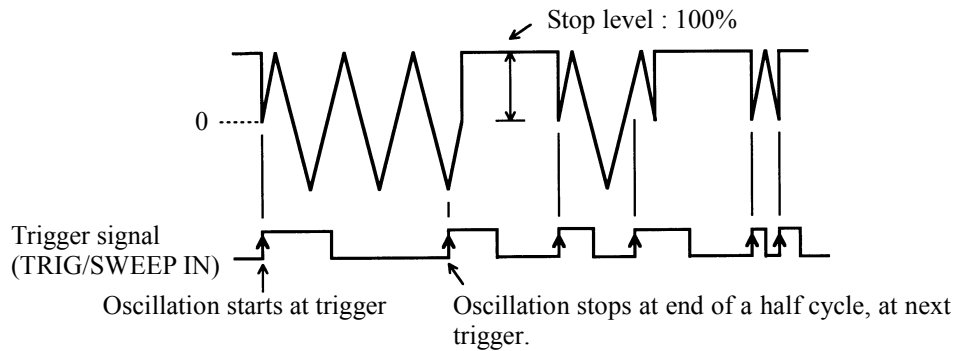

**Operation:**

(1) Set burst oscillation TYPE to trig'd gate (T-GATE)

- ① Press the <sup>MODE</sup> key, then the <sup>BURST</sup> key.
- ② Use the  and  keys to produce the following display (TYPE flashes)

```

BURST TRIG GATE ▶
BURST : TYPE MARK SPACE STOP-LEVEL
  
```



- ③ Press <sup>ENTER</sup> key, then use the  and  keys to produce the following display (T-GATE flashes).

```





◀ T-GATE
T-GATE : TYPE SOURCE STOP-LEVEL
  
```

- ④ This sets the burst oscillation type for triggered gate. Press the <sup>EXIT</sup> key once to release the type setting mode.



**(2) Select trigger source (SOURCE)**

- ① Use the  and  keys to produce the following display (SOURCE flashes).





- ② Press the  key.  
 ③ Select rising () using the  dial. () indicates falling of the trigger signal  
 ④ After making a selection, press the  key once to exit the trigger source selection.



**(3) Set STOP-LEVEL**

- ① Use the  and  keys to produce the following display (STOP-LEVEL flashes).



- ② Press the  key.  
 ③ Turn the  dial to produce the following display (ON flashes).



- ④ Press the  key, then set the stop level with the keypad or  dial. For example, set to 100 %.

The stop level is the percentage with respect to the maximum positive (+100 %) and negative (-100 %) amplitude.

- ⑤ After setting, press the  key to release the setting mode.

The above sets the burst oscillation (type: triggered gate). Oscillation alternates between start and stop each time a signal () is applied to the TRIG/SWEEP IN connector.

**Other settings:**

- **Stop level off** : Oscillation stops after the trigger signal is applied, at the end of a half cycle (i.e., at the phase set by  $\text{ENTRY} \rightarrow \text{PHASE}$  ) or plus 180 degrees from that phase.

- **Manual trigger** : When a manual trigger signal is desired, press the  $\text{MAN TRIG}$  key. Oscillation starts and stops each time the key is pressed.

However, produce the manual trigger signal after the oscillation has stopped. If oscillation is from an external signal, oscillation will not stop even if the  $\text{MAN TRIG}$  key is pressed.

Oscillation stops during power-on.

- **To generate the trigger signal via remote control (GPIB or USB)**, set the GET command or TRG command from the remote control interface.

Also, set the trigger source to EXT  $\uparrow$ .

For details of the remote control command,  "Remote Control Instruction Manual", cf.

- Burst oscillation (type: triggered gate) setting items (BURST menu)

TYPE: T-GATE

SOURCE (trigger source) [ EXT  $\downarrow$ , EXT  $\uparrow$  ]

STOP-LEVEL [OFF, ON[%]]

PHASE (phase when oscillation starts) \* ENTRY menu

## 4.2 Sweep

### ■ Sweep (Mode: Single) ( → → **MODE : SINGLE** )

In a Sweep (Mode: Single), oscillation occurs by varying parameters such as the frequency and amplitude one time between the start and stop settings. Oscillation continues after the sweep is completed. Operation to produce a waveform output with frequency that varies linearly and continuously is described. The setting example is a sinewave with arbitrary amplitude and DC offset.

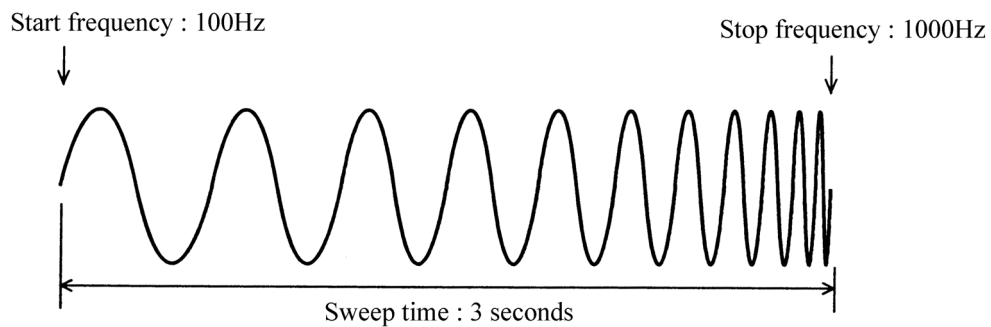

#### Operation:

##### (1) Set sweep **MODE** to **SINGLE**

- ① Press the  key, then the  key.
- ② Use the  and  keys to produce the following display (MODE flashes).

```

S I N G L E   C O N T   G A T E D
F - S W P : T Y P E   S O U R C E   M O D E   ▶
    
```



- ③ Press , then use the  and  keys to produce the following display (SINGLE flashes).

```



S I N G L E   C O N T   G A T E D
F - S W P : T Y P E   S O U R C E   M O D E   ▶
    
```

- ④ This sets the sweep mode for single. Press the  key once to release mode select.

**(2) Set the sweep TYPE to FREQ**

- ① Use the  and  keys to produce the following display (TYPE flashes).





- ② Press the  key, then use the  and  keys to produce the following display (FREQ flashes).







- ③ This sets the sweep type for frequency. Press the  key once to release the type setting mode.



**(3) Select sweep FUNCTION**

- ① Use the  and  keys to produce the following display (FUNCTION flashes).





- ② Press the  key.
- ③ Press the  key, then select  with the  dial.
- ④ After selecting, press the  key once to release the function select mode.

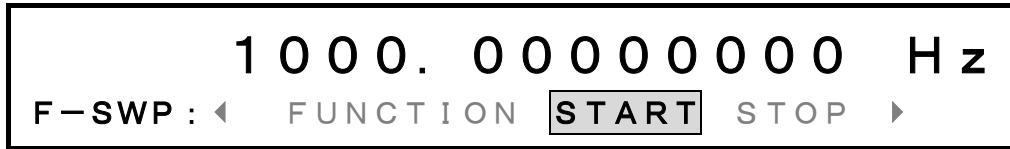

**(4) Set START frequency**

- ① Use the  and  keys to produce the following display (START flashes).





- ② Press  key.
- ③ Set the start frequency with the keypad or  dial.  
For example, set to 100 Hz.
- ④ After setting, press the  key once to release the start frequency setting mode.

**(5) Set STOP frequency**



- ① Use the  and  keys to produce the following display (STOP flashes).





- ② Press  key.
- ③ Set the stop frequency with the keypad or  dial.  
For example, set to 1000 Hz.
- ④ After setting, press the  key once to release the stop frequency setting mode.



**(6) Set sweep TIME**

- ① Use the  and  keys to produce the following display (TIME flashes).





- ② Press  key.
- ③ Set the sweep time with the keypad or  dial.

For example, set to 3 seconds.

- ④ After setting, press the  key once to release the sweep time setting mode.

**(7) Sweep operation**





- ① Sweep starts when the  key is pressed.

When sweep is started, an existing output frequency is quickly changed to the start frequency. If desiring to set the start frequency output beforehand, press the  key.

The output quickly changes to the start frequency, then sweeps to the stop frequency in 3 seconds (in this example). Oscillation then continues at the stop frequency.

When the  key is again pressed, sweep begins at the stop frequency and ends at the start frequency.

**Other operations:**

- **Sweep stop** : Press the  key. When sweep is stopped at the stop value at single sweep end or during sweep, press the  key to set the start value.
- **Sweep pause** : Press the  key. Again press the  key to resume sweep.
- **Single sweep operation examples**

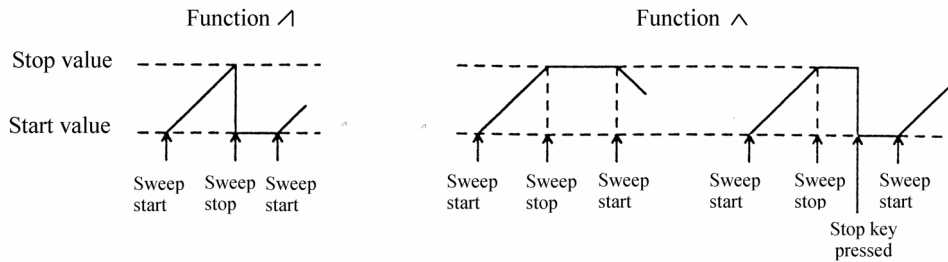

• **Dead time and trigger delay**

- : Triggers input within 100 ms of completion of the last sweep are ignored. The trigger delay for the first sweep after power-on or a parameter change is 40 ms. Otherwise, it is 2 ms.

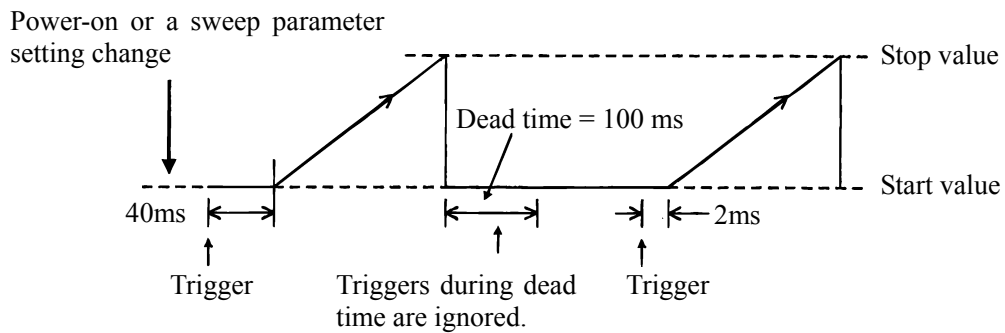

• **External sweep start**

- : Set the sweep trigger source to EXT and select rising or falling. Supply an external signal to the front panel TRIG/SWEEP IN connector. However, note that retrigger cannot be applied for 100 ms after sweep start. During a sweep, the sweep restarts if a trigger is input.







• **External sweep pause**

- : Supply a low level signal to the rear panel SWEEP PAUSE IN connector. Note that sweep restarts at high level or open input.

- **FUNCTION** determines the sweep type.

: For example,  provides step-type change of output (e.g., frequency) at the sweep time halfway point. LIN/LOG provides linear or logarithmic variation of the output with respect to the time axis.

-  LIN  
LOG
-  LIN  
LOG
- 
- SIN () LIN  
LOG

- **Internal sweep trigger source**

: The trigger signal is generated at the following rate, then sweep is conducted. However, the trigger interval is 100 ms even if set to less.

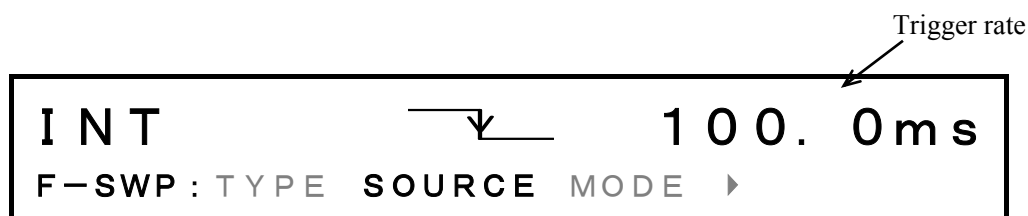

- **START-STATE and STOP-STATE** : Respectively set the output to start and stop values.

Since the sweep auxiliary output becomes the respective start and stop states, the full scale of the recorder can be adjusted and the state of external equipment can be checked. The Start-State is the same as pressing the

 key (during single sweep).

Relation ship between sweep values and sweep auxiliary output  "4.2 Sweep (■ Sweep value and Z-MARKER/SYNC/ X- DRIVE outputs)", cf.

- **Sweep type set to duty**

: Output waveform fixed to squarewave (variable duty) and waveform (Function) cannot be selected.

During sweep, multiple pulses may be produced within 1 period output as indicated in the figure.

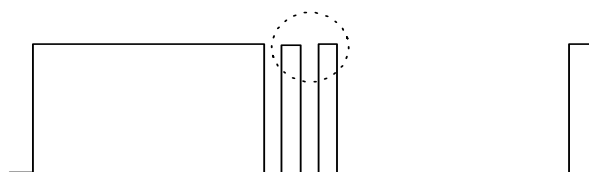

- **To generate the trigger signal via remote control (GPIB or USB)**, set the TRG command from the remote control interface.

For details of the remote control command,  "Remote Control Instruction Manual", cf.

■ **Sweep (Mode: Continuous)** (  →  → **MODE : CONT**)

In a Sweep (Mode: Continuous), oscillation occurs by varying parameters such as the frequency and amplitude continuously between the start and stop settings.

Operation is described for producing a waveform output with linear and continuously frequency.

The waveform is a sinewave with arbitrary Amplitude and DC offset.

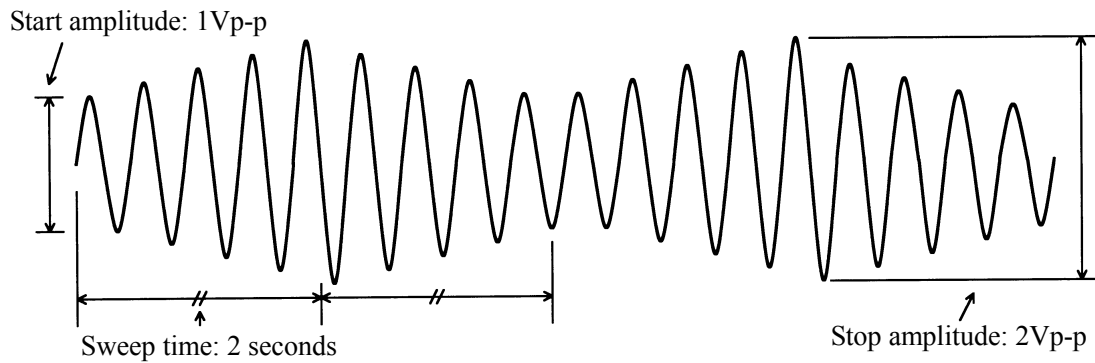

**Operation:**

**(1) Set sweep MODE to continuous (CONT)**

- ① Press the  key, then the  key.
- ② Use the  and  keys to produce the following display (MODE flashes).





- ③ Press the  key, then use the  and  keys to produce the following display (CONT flashes).



- ④ This completes setting the sweep mode to continuous. Press the  key once to release the setting mode.



**(2) Set sweep TYPE to amplitude (AMPTD)**

- ① Use the  and  keys to produce the following display (TYPE flashes).

```

FREQ  AMPTD  OFFSET  ▶
F-SWP : TYPE  MODE  FUNCTION  START  ▶

```

- ② Press the  key, then use the  and  keys to produce the following display (AMPTD flashes).



```

FREQ  AMPTD  OFFSET  ▶
A-SWP : TYPE  MODE  FUNCTION  START  ▶

```

- ③ This completes setting the sweep type to amplitude. Press the  key once to release the setting mode.





**(3) Select the sweep FUNCTION**

- ① Use the  and  keys to produce the following display (FUNCTION flashes).



```

LIN  /
A-SWP : TYPE  MODE  FUNCTION  START  ▶

```

- ② Press the  key.
- ③ Press the  key, then turn the  dial to select  $\wedge$ .
- ④ After selecting, press the  key once to release the function select mode.



**(4) Set the START amplitude (START)**

- ① Use the  and  keys to produce the following display (START flashes).

```

  AMPTD  0. 1000  Vp-p
A-SWP : TYPE  MODE  FUNCTION  START  ▶



```

- ② Press the  key.
- ③ Set the start amplitude with the key pad or  dial.

For example, set to 1 Vp-p.

- ④ After setting, press the  key once to release the start setting mode.



**(5) Set the STOP amplitude (STOP)**

- ① Use the  and  keys to produce the following display (STOP flashes).

```

  AMPTD  0. 1000  Vp-p
A-SWP : ◀  STOP  TIME  CENTER  SPAN  ▶



```

- ② Press the  key.
- ③ Set the stop amplitude with the key pad or  dial.



For example, set to 2Vp-p.

- ④ After setting, press the  key once to release the stop setting mode.

**(6) Set the sweep TIME**

- ① Use the  and  keys to produce the following display (TIME flashes).



- ② Press the  key.
- ③ Set the sweep time with the key pad or  dial.

For example, set to 2 seconds.

- ④ After setting, press the  key once to release the sweep time setting mode.





**(7) Sweep operation**





- ① Press the  key, then sweep starts.

The output quickly changes to the sweep start amplitude.

If desiring to set the start amplitude output beforehand, press the  key.

**Other operations:**

- **Sweep stop** : Press the  key. This becomes the sweep start value.
- **Sweep pause** : Press the  key. To resume sweep, again press the  key.
- **External pause** : Supply a low level signal to the rear panel SWEEP PAUSE IN connector.  
Note that sweep restarts at high level or open input
- **FUNCTION** : The function determines the sweep type. For example,  provides step-type change of output (e.g., frequency) at the sweep time halfway point. LIN/LOG provides linear or logarithmic variation of the output with respect to the time axis.

-  LIN  
LOG
-  LIN  
LOG
- 
-  LIN  
LOG

- **START-STATE and STOP-STATE:** Respectively set the output start and stop values. Since the sweep auxiliary output becomes the respective start and stop states, the full scale of the recorder can be adjusted and the state of external equipment can be checked.

The Start-State is the same as pressing the  key (during single sweep).

Relation ship between sweep values and sweep auxiliary output  
 "4.2 Sweep (■ Sweep value and Z-MARKER/SYNC/X- DRIVE outputs)", cf.

- **Sweep type set to duty** : Output waveform fixed to squarewave (variable duty) and waveform (Function) cannot be selected.

During sweep, multiple pulses may be produced within 1 period output as indicated in the figure.

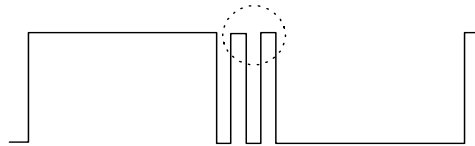



■ Sweep (Mode: Gated) (  <sup>MODE</sup> →  <sup>SWEEP</sup> → **MODE : GATED** )

In a Sweep (Mode: Gated), oscillation occurs by varying parameters such as the frequency and amplitude one time between the start and stop settings. Oscillation stops before the sweep starts and when the sweep is completed.

Operation to produce a waveform output with frequency that varies in step form and oscillation stops is described.

The setting example is a sinewave with arbitrary amplitude and DC offset 0.

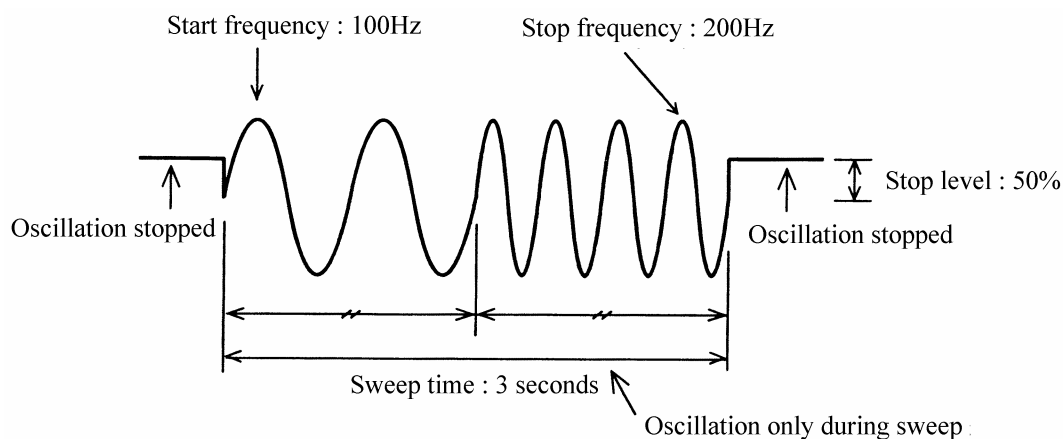

**Operation:**

**(1) Set sweep MODE to GATED**

- ① Press the  <sup>MODE</sup> key, then the  <sup>SWEEP</sup> key.
- ② Use the  and  keys to produce the following display (MODE flashes).

```

S I N G L E   C O N T   G A T E D
F - S W P : T Y P E   S O U R C E   M O D E   ▶

```

- ③ Press the  <sup>ENTER</sup> key, then use the  and  keys to produce the following display (GATED flashes).



```

S I N G L E   C O N T   G A T E D
F - S W P : T Y P E   S O U R C E   M O D E   ▶

```

- ④ This completes setting the sweep mode to gated. Press the  <sup>EXIT</sup> key once to release the setting mode.

**(2) Set sweep TYPE to FREQ**

- ① Use the  and  keys to produce the following display (TYPE flashes).





- ② Press the  key, then use the  and  keys to produce the following display (FREQ flashes).







- ③ This completes setting the sweep type to frequency. Press the  key once to release the setting mode.

**(3) Select the sweep FUNCTION**

- ① Use the  and  keys to produce the following display (FUNCTION flashes).





- ② Press the  key.
- ③ Press the  key, then select  with the  dial
- ④ After selecting, press the  key once to release the function select mode.

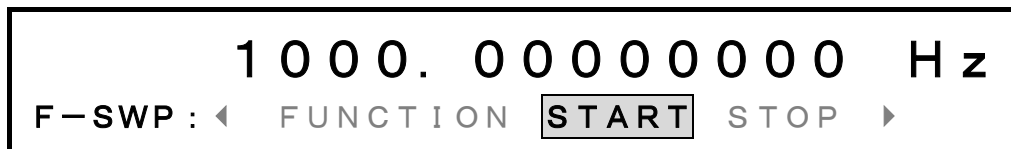

**(4) Set the START frequency**

- ① Use the  and  keys to produce the following display (START flashes).





- ② Press the  key.
- ③ Set the frequency with the keypad or  dial.  
For example, set to 100 Hz.
- ④ After setting, press the  key once to release the start frequency setting mode.



**(5) Set the STOP frequency**

- ① Use the  and  keys to produce the following display (STOP flashes).





- ② Press the  key.
- ③ Set the frequency with the keypad or  dial.  
For example, set to 200 Hz.
- ④ After setting, press the  key once to release the stop frequency setting mode.

**(6) Set the sweep TIME**

- ① Use the  and  keys to produce the following display (TIME flashes).





- ② Press the  key.
- ③ Set the sweep time with the keypad or  dial.



For example, set to 3 seconds.

- ④ After setting, press the  key once to release the sweep time setting mode.



**(7) Set the STOP-LEVEL**

- ① Use the  and  keys to produce the following display (STOP-LEVEL flashes).



- ② Press the  key.
- ③ Turn the  dial to produce the following display (ON flashes).





- ④ Press the  key, then set the stop level with the keypad or  dial. For example, set to 50 %.

The stop level is a percentage with respect to the maximum positive and negative amplitudes taken respectively as +100 % and -100 %.





- ⑤ After setting, press the  key to exit stop level setting.

**(8) Start sweep**

① Press the  key.

In this example, sweep ends after 3 seconds and oscillation stops. Again press the  key to sweep from the stop to the start frequency.

**Other operations:**



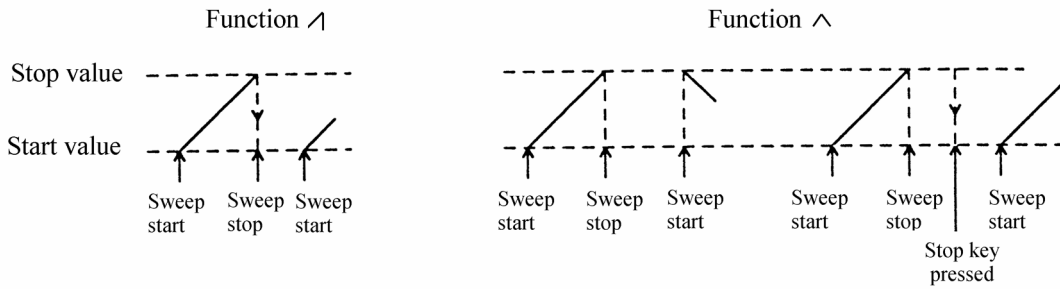

- **Sweep stop** : Press the  key. Oscillation stops. When sweep is stopped at gated sweep end or during sweep, press the  key to set the start value. (Oscillation stops)
- **Sweep pause** : Press the  key. To resume sweep, again press the  key.
- **Gated sweep operation examples**



- **External start** :Change the sweep trigger source to EXT and select rising or falling. Supply an external signal to the front panel TRIG/SWEEP IN connector. Observe that retrigger is not accepted for 100 ms after sweep start.



- **External sweep pause** : Supply a low level signal to the rear panel SWEEP PAUSE IN connector. Note that sweep restarts at high level or open input
- **FUNCTION** : The function determines the sweep type. For example,  provides step-type change of output (e.g., frequency) at the sweep time halfway point. LIN/LOG provides linear or logarithmic variation of the output with respect to the time axis.

-  LIN  
LOG
-  LIN  
LOG
- 
- SIN () LIN  
LOG

- **Internal trigger source**

: The internal trigger signal is produced at the rate indicated below. Even is set to less than 100 ms, the trigger is applied only at 100 ms intervals.

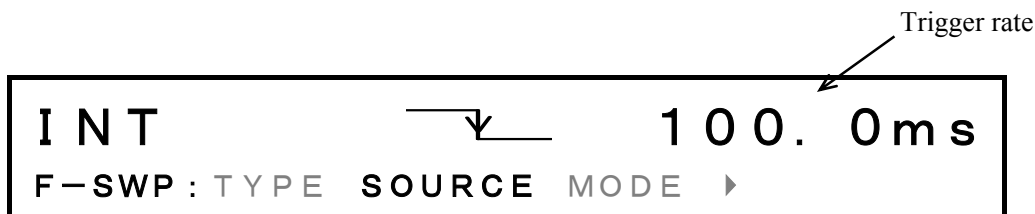

- **START-STATE and STOP-STATE** : Set output to start and stop values, respectively.

Both START-STATE and STOP-STATE oscillation can be conducted together with a gated sweep. Since sweep synchronization output becomes the respective start and stop states, full-scale adjustments of the recorder and the status of external equipment can be checked.

☞ "4.2 Sweep (■ Sweep value and Z-MARKER/SYNC/X- DRIVE outputs)", cf.

- **Sweep type set to duty** : Output waveform fixed to squarewave (variable duty) and waveform (Function) cannot be selected.

During sweep, multiple pulses may be produced within 1 period output as indicated in the figure.

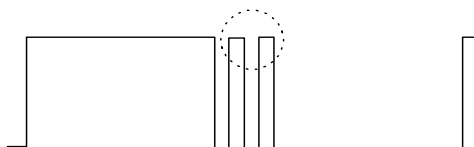

- If the frequency is low and the sweep rest period short, in some cases, oscillation may not stop immediately at the end of sweep.
- When an amplitude sweep is set with 0 as the start or stop values and the sweep function is set with LOG  $\sim$  / LOG  $\nearrow$  / LOG  $\wedge$ , "SETTING CONFLICT 001" is displayed continuously during a short trigger cycle and the menu may not be displayed. In such cases, switch the trigger source, or stop input to the SWEEP PAUSE IN connector.

**■ CENTER, SPAN, MARKER, MKR → CTR**

- **Center** is the sweep center value, while **span** is the range setting. The relationship among center, span, start and stop is as follows.

Values cannot be entered for CENTER and SPAN, however, if the sweep type is set from a user unit that has the log function.

- When start is changed:

Stop does not change.

$$\text{CENTER} = (\text{START} + \text{STOP}) \div 2$$

$$\text{SPAN} = |\text{START} - \text{STOP}|$$

- When stop is changed:

Start does not change.

$$\text{CENTER} = (\text{START} + \text{STOP}) \div 2$$

$$\text{SPAN} = |\text{START} - \text{STOP}|$$

- When center is changed:

Span does not change.

$$\text{START} = \text{CENTER} -/+ (\text{SPAN} \div 2)$$

$$\text{STOP} = \text{CENTER} +/- (\text{SPAN} \div 2)$$

- When span is changed:

Center does not change.

$$\text{START} = \text{CENTER} - /+ (\text{SPAN} \div 2)$$

$$\text{STOP} = \text{CENTER} +/- (\text{SPAN} \div 2)$$

- A value that changes the SWEEP Z-MARKER OUT signal is set for MARKER.

- MKR→CTR copies the marker value to the center value.



## ■ Summary of the sweep setting items





- The following summarizes the items that need to be set during a sweep operation (in the SWEEP menu).

TYPE (sweep target) [FREQ, AMPTD, OFFSET, PHASE, DUTY]

SOURCE (trigger source) [EXT , EXT , INT [s]

\* Set when the sweep mode is SINGLE or GATED

MODE (sweep mode) [SINGLE, CONT, GATED]

FUNCTION (sweep waveform) [LIN , LOG , , LIN SIN, LOG SIN, LIN , LOG 

START (sweep start value)/STOP (sweep stop value)

or

CENTER (sweep center value)/SPAN (sweep width)

} Sweep range setting

TIME (sweep time) [s]

STOP-LEVEL

PHASE (phase when oscillation starts) \* main menu

} Set when the sweep mode is GATED

MARKER (Marker value)

MKR→CTR (Copying of the marker value to the center value)

- Sweep operations

- Main operation

START (sweep start)

STOP (sweep end/sweep start state)

\*For subsequent operation when the sweep has been completed, the state is reset to the sweep start state.

PAUSE (sweep pause/restart)

- In the SWEEP menu

START-STATE (sweep start state)

STOP-STATE (sweep stop state)

## ■ Sweep (modulation) steps and step width

Sweep and modulation outputs are changed by software. Methods for estimating sweep, modulation step number (number of output changes between start and stop values) and step width (variation width per change) are indicated below.

Sweep is described here. For modulation, replace sweep function with modulation waveform, sweep type with modulation type, and sweep time with modulation period, respectively.

The modulation period is determined as follows.

When the waveform is SIN,  $\wedge$ ,  $\vee$ ,  $\sqcap$ ,  $\sqcup$ : Modulation period =  $1 \div (\text{Modulation frequency} \times 2)$

When the waveform is  $\swarrow$ ,  $\searrow$ : Modulation period =  $1 \div \text{Modulation frequency}$

### • Step number derivation

(1) Sweep function is step ( $\square$ ):

Step number = Sweep time [s]  $\times$  10000 (raise up, even number \*1)

(2) Sweep function is other than step and sweep type is frequency:

① Sweep time is 25 ms and below:

Step number = Sweep time [s]  $\times$  10000

② Sweep time is more than 25 to 31.25 ms and below:

Step number = 250 (fixed)

③ Sweep time is more than 31.25 ms:

Step number = Sweep time [s]  $\times$  8000

(3) Sweep function is other than step and sweep type is other than frequency:

① Sweep time is 50 ms and below:

Step number = Sweep time [s]  $\times$  10000

② Sweep time is more than 50 to 62.5 ms and below:

Step number = 250 (fixed)

③ Sweep time is more than 62.5 ms:

Step number = Sweep time [s]  $\times$  8000

\*1: If raising up results in odd number, -1.

**• Deriving step width**

During linear sweep, step width =  $\frac{\text{Span}}{\text{Step number} - 1}$

During logarithmic sweep, step width =  $\log_{10}^{-1} \left[ \log_{10} \frac{\text{stop}}{\text{start}} \div (\text{step no.} - 1) \right]$

Step width during log sweep changes with step progression.

The marker output is synchronized with the sweep step output. The difference between marker setting and actual output is  $\pm$  step width.

■ Sweep value and Z-MARKER/SYNC/X-DRIVE outputs

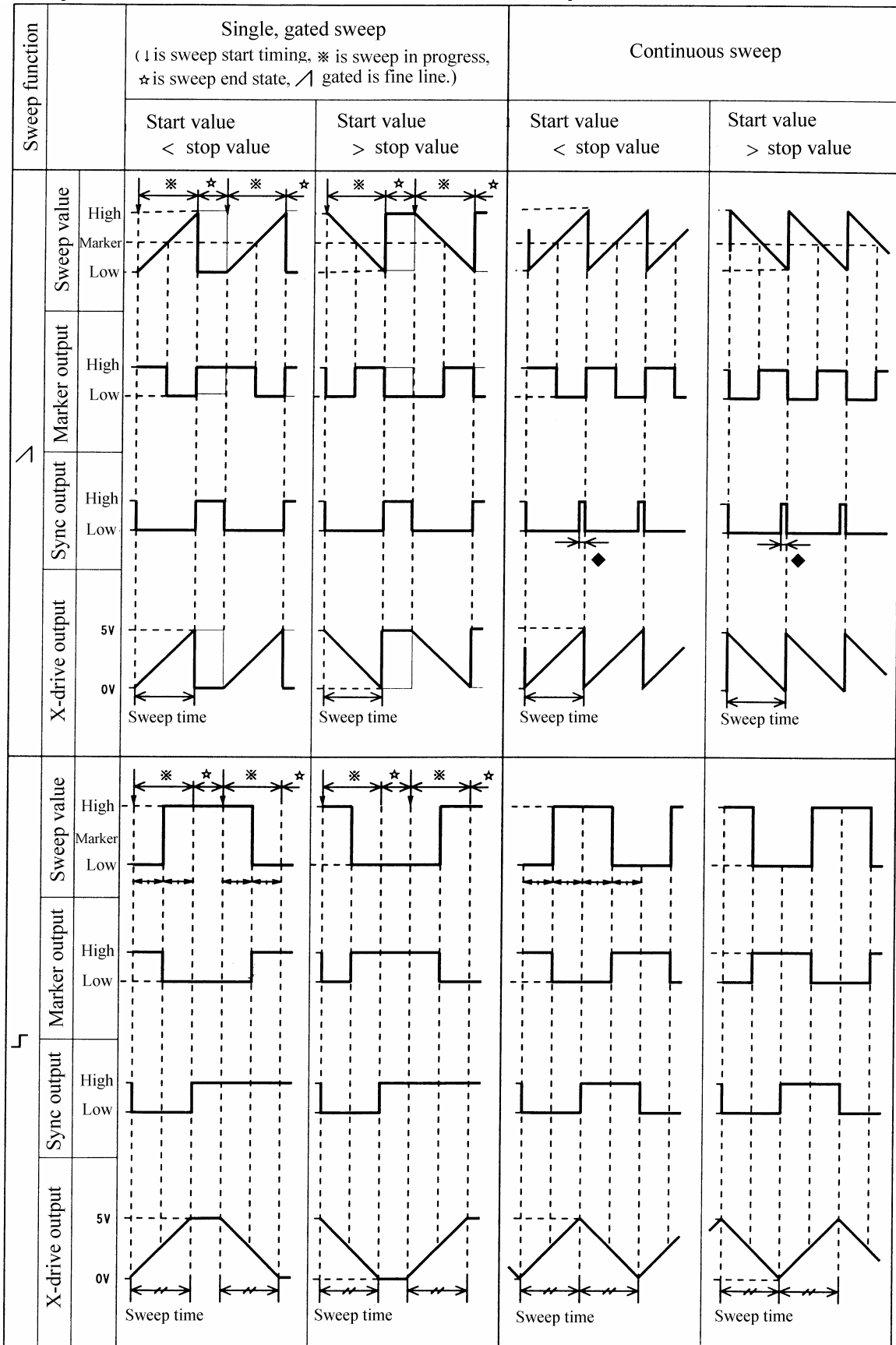

◆ is approx. 100 to 125 μs

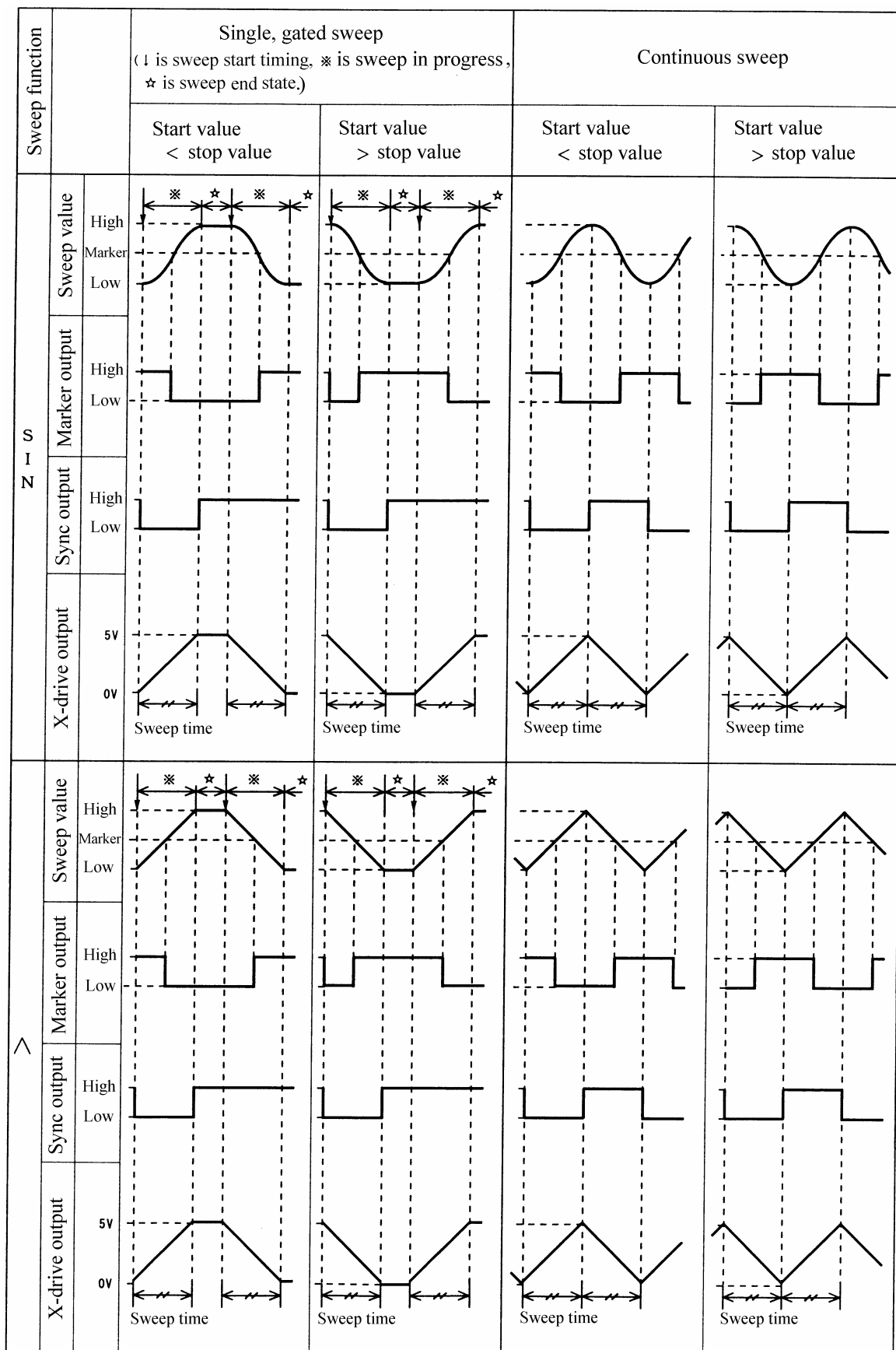

## 4.3 Modulation

### ■ Frequency modulation (FM) ( → → TYPE : FM)

Operation to produce a frequency modulated waveform output is described.  
The example is a sinewave, 1 kHz, amplitude and DC offset arbitrary.

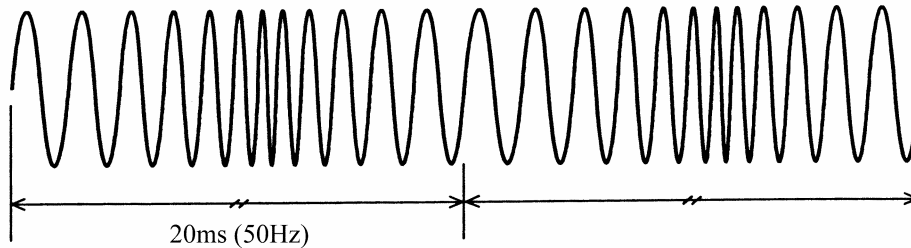

Frequency is 1 kHz varying  $\pm 250$  Hz  
Deviation period is 20 ms (50 Hz)

#### Operation:

##### (1) Set modulation TYPE to frequency (FM)

- ① Press the  key, then the  key.
- ② Use the  and  keys to produce the following display (TYPE flashes).

```

FM  AM  OFSM  PM  PWM
FM : TYPE  DEVIATION  FREQ  FUNCTION
    
```



- ③ Press the  key, then use the  and  keys to produce the following display (FM flashes).

```



FM  AM  OFSM  PM  PWM
FM : TYPE  DEVIATION  FREQ  FUNCTION
    
```

- ④ This sets the modulation type for frequency. Press the  key once to release the type setting mode.

**(2) Set the frequency DEVIATION**

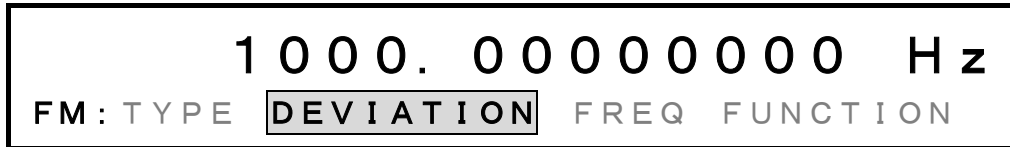
- ① Use the  and  keys to produce the following display (DEVIATION flashes).





- ② Press the  key.
- ③ Set the deviation with the keypad or  dial.



For example, set to 500 Hz.

- ④ After setting, press the  key once to exit frequency deviation setting.

**(3) Set the modulation FREQ**

- ① Use the  and  keys to produce the following display (FREQ flashes).





- ② Press the  key.
- ③ Set the frequency with the keypad or  dial.



For example, set to 50 Hz (20 ms).

- ④ After setting, press the  key once to release the modulation setting mode.

**(4) Select the modulation waveform (FUNCTION)**

- ① Use the  and  keys to produce the following display (FUNCTION flashes).



- ② Press the  key, then use the  and  keys to produce the following display (SIN flashes).



- ③ After making a selection, press the  key to exit function setting.

The above completes frequency modulation setting.

**Other operations:**

- When the oscillation mode is changed to modulation (MODU), modulation occurs at the setting at that time point.





**To stop modulation:** Press the  key. Resume modulation by pressing the  key.

- Setting items at frequency modulation (MODU menu)

TYPE: FM

DEVIATION (frequency deviation) [Hz]

FREQ (modulation frequency) [Hz]

FUNCTION (modulation waveform) [SIN, , , , ]



■ **Amplitude modulation (AM)** (  →  → **TYPE : AM** )

Operation to produce an AM waveform output is described below.

The example is a sinewave, 1800 Hz, amplitude 1.5 V<sub>p-p</sub> and DC offset 0 V.

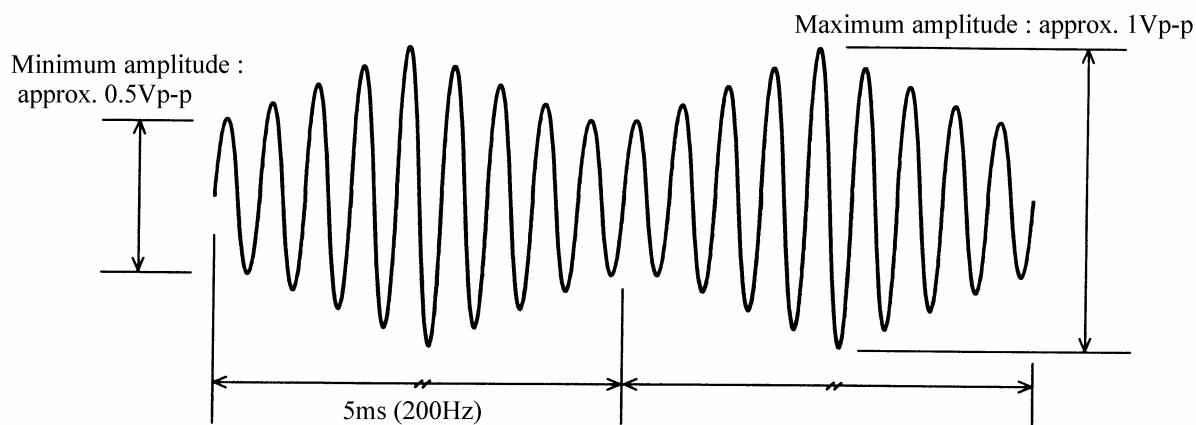

**Operation:**

**(1) Set modulation TYPE to amplitude (AM)**

- ① Press the  key, then the  key.
- ② Use the  and  keys to produce the following display (TYPE flashes).

```

FM  AM  OFSM  PM  PWM
FM : TYPE  DEVIATION  FREQ  FUNCTION
  
```



- ③ Press the  key, then use the  and  keys to produce the following display (AM flashes).

```

FM  AM  OFSM  PM  PWM
FM : TYPE  DEPTH  FREQ  FUNCTION
  
```

- ④ This sets the modulation type for amplitude. Press the  key once to release the type setting mode.

**(2) Set modulation DEPTH (width of amplitude variance)**

- ① Use the  and  keys to produce the following display (DEPTH flashes).





- ② Press the  key.  
 ③ Use the keypad or  dial to set the modulation depth.



For example, set to 33 %.

- ④ Press the  key once to release the modulation depth setting mode

**(3) Set the modulation FREQ (frequency with varying amplitude)**

- ① Use the  and  keys to produce the following display (FREQ flashes).





- ② Press the  key.  
 ③ Use the keypad or  dial to set the modulation frequency.

For example, set to 200 Hz (5ms).

- ④ After setting, press the  key once to release the modulation frequency setting mode.

**(4) Select modulation waveform (FUNCTION)**

- ① Use the  and  keys to produce the following display (FUNCTION flashes).



- ② Press the  key, then use the  and  keys to produce the following display (SIN flashes).





- ③ After selecting, press the  key to release the setting mode.

The above completes amplitude modulation setting.

**Other operations:**

- When the oscillation mode is changed to modulation (MODU), modulation occurs at the setting at that time point.

**• To stop modulation**

: Press the  key. Resume modulation by pressing the  key.

**• Amplitude setting vs. maximum or minimum amplitudes**

: Max. amplitude = Amplitude setting  $\div$  2 (1 + (depth [%]  $\div$  100))

Min. amplitude = Amplitude setting  $\div$  2 (1 - (depth [%]  $\div$  100))





- At 0 % depth, the output amplitude is 1/2 the setting. At 100 % depth, the output amplitude is the same as the setting.

**• Setting items at amplitude modulation (MODU menu)**

TYPE: AM

DEPTH (modulation depth) [%]

FREQ (modulation frequency) [Hz]

FUNCTION (modulation waveform) [SIN, , , , ]

■ **DC offset modulation (OFSM)** (  →  → **TYPE : OFSM** )

Operation to produce a DC offset modulated waveform output is described below. The example refers to a sinewave, 2 kHz, amplitude 1 Vp-p and DC offset 0 V.

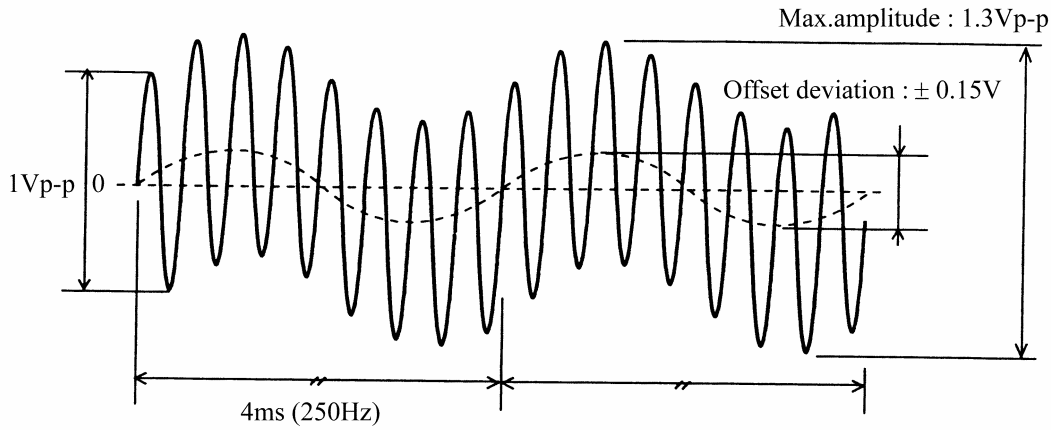

**Operation:**

**(1) Set modulation TYPE to DC offset (OFSM)**

- ① Press the  key, then the  key.
- ② Use the  and  keys to produce the following display (TYPE flashes).





- ③ Press the  key, then use the  and  keys to produce the following display (OFSM flashes).





- ④ This sets the modulation type for DC offset. Press the  key once to release the type setting mode.

**(2) Set the DC offset DEVIATION**

- ① Use the  and  keys to produce the following display (DEVIATION flashes).





- ② Press the  key.
- ③ Set the deviation with the keypad or  dial.



For example, set to 0.3 V.

- ④ After setting, press the  key once to release the deviation setting mode.

**(3) Set the modulation FREQ**

- ① Use the  and  keys to produce the following display (FREQ flashes).





- ② Press the  key.
- ③ Set the frequency with the keypad or  dial.



For example, set to 250 Hz (4 ms).

- ④ After setting, press the  key once to release the modulation frequency setting mode.

**(4) Select modulation waveform (FUNCTION)**

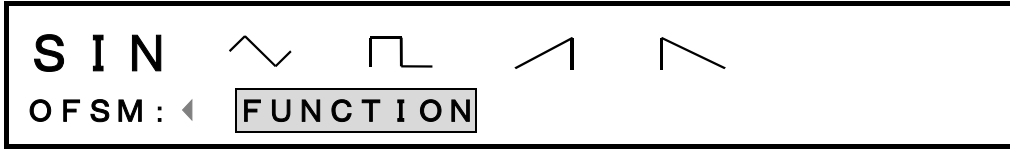
① Use the  and  keys to produce the following display (FUNCTION flashes).



② Press the  key, then use the  and  keys to produce the following display (SIN flashes).



③ After selecting, press the  key to release the setting mode.

The above completes DC offset modulation setting.



**Other operations:**

• **Amplitude setting vs. maximum amplitudes**

: Max. amplitude = Amplitude setting + DC offset deviation

• When the oscillation mode is changed to modulation (MODU), modulation occurs at the setting at that time point.

**To stop modulation**





: Press the  key. Resume modulation by pressing the  key.

• Setting items at DC offset deviation (MODU menu)

TYPE: OFSM

DEVIATION (dc offset deviation) [V]

FREQ (modulation frequency) [Hz]

FUNCTION (modulation waveform) [SIN, , , , ]

## ■ Phase modulation (PM) ( → → TYPE : PM)

Operation to produce a phase modulated waveform output is described below. The example is a sinewave, 1 kHz, DC offset 0 V, phase and amplitude arbitrary.

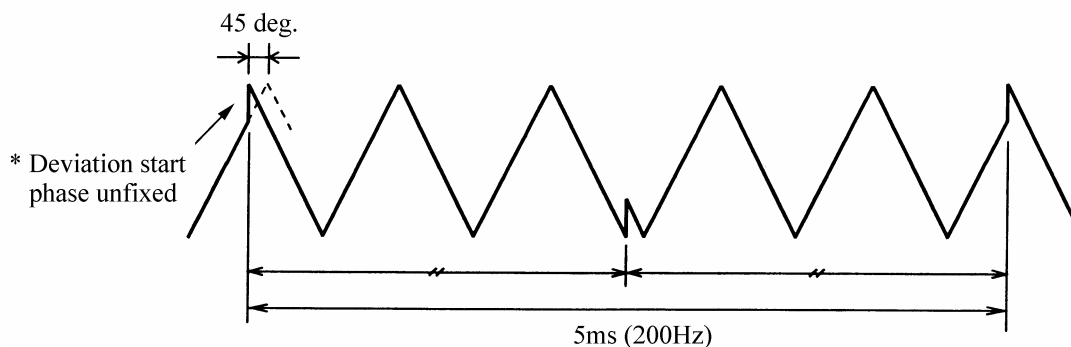

### Operation:

#### (1) Set modulation TYPE to phase (PM)

- ① Press the  key, then the  key.
- ② Use the  and  keys to produce the following display (TYPE flashes).

```

FM  AM  OFSM  PM  PWM
FM : TYPE  DEVIATION  FREQ  FUNCTION
  
```



- ③ Press the  key, then use the  and  keys to produce the following display (PM flashes).

```



FM  AM  OFSM  PM  PWM
PM : TYPE  DEVIATION  FREQ  FUNCTION
  
```

- ④ This sets the modulation type for phase. Press the  key once to release the type setting mode.

**(2) Set the phase DEVIATION**

- ① Use the  and  keys to produce the following display (DEVIATION flashes).





- ② Press the  key.
- ③ Set the deviation with the keypad or  dial.



For example, set to 45 degrees.

- ④ After setting, press the  key once to exit phase deviation setting.

**(3) Set the modulation FREQ**

- ① Use the  and  keys to produce the following display (FREQ flashes).





- ② Press the  key.
- ③ Set the frequency with the keypad or  dial.

For example, set to 200 Hz (5 ms).



- ④ After setting, press the  key once to release the modulation frequency setting mode.





**(4) Select the modulation waveform (FUNCTION)**

- ① Use the  and  keys to produce the following display (FUNCTION flashes).

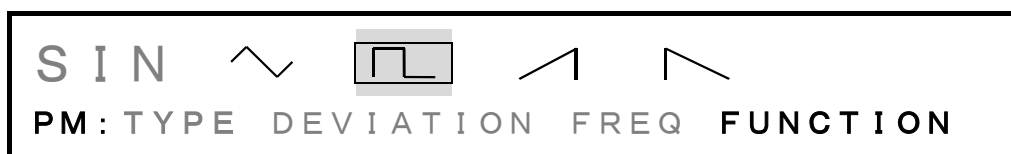

- ② Press the  key, then use the  and  keys to produce the following display (□ flashes).



- ③ After selecting, press the  key to release the function setting mode.

The above completes phase modulation setting.

**Other operations:**

- When the oscillation mode is changed to modulation (MODU), modulation occurs at the setting at that time point.





**To stop modulation :** Press the  key. Resume modulation by pressing the  key.

- Setting items at phase modulation (MODU menu)

TYPE: PM

DEVIATION (phase deviation) [deg]

FREQ (modulation frequency) [Hz]

FUNCTION (modulation waveform) [SIN, , , , ]

■ **Pulse width modulation (PWM)** (  →  → **TYPE : PWM**)

Operation to produce a pulse width modulated waveform output is described below. The example is a squarewave (duty variable), duty 50 %, frequency 800 Hz, amplitude and DC offset arbitrary.

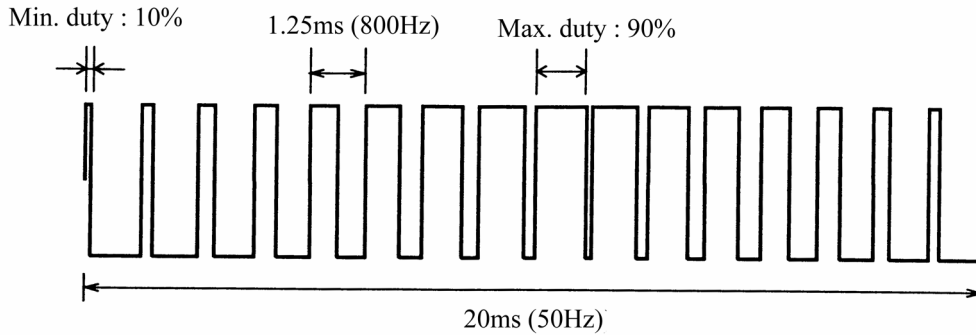

**Operation:**

**(1) Set modulation TYPE to pulse width (PWM)**

- ① Press the  key, then the  key.
- ② Use the  and  keys to produce the following display (TYPE flashes).





- ③ Press the  key, then use the  and  keys to produce the following display (PWM flashes).





- ④ This sets the modulation type for pulse width. Press the  key once to release the type setting mode.

The waveform is automatically set to squarewave (variable duty) during PWM. The waveform (FUNCTION) cannot be selected.



**(2) Set the pulse width DEVIATION (amount of pulse-width variance)**

- ① Use the  and  keys to produce the following display (DEVIATION flashes).



		20.0000 %
PWM : TYPE	DEVIATION	FREQ FUNCTION

- ② Press the  key, then set the deviation with the keypad or  dial. For example, set to 80 %.
- ③ After setting, press the  key once to release the pulse with deviation setting mode.



**(3) Set the modulation FREQ (frequency with varying pulse-width)**

- ① Use the  and  keys to produce the following display (FREQ flashes).

		100.00 Hz
PWM : TYPE	DEVIATION	FREQ
		FUNCTION

- ② Press the  key.  
Set the frequency with the keypad or  dial.  
For example, set to 50 Hz (20 ms).
- ③ After setting, press the  key once to release the modulation frequency setting mode.

**(4) Select modulation waveform (FUNCTION)**

① Use the  and  keys to produce the following display (FUNCTION flashes).





② Press the  key, then use the  and  keys to produce the following display (SIN flashes).







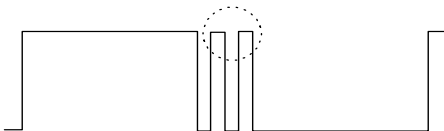

③ After selecting, press the  key to release the setting mode.

The above completes pulse width modulation setting.

**Other operations:**

- When the oscillation mode is changed to modulation (MODU), modulation occurs at the setting at that time point.
- **To stop modulation :** Press the  key. Resume modulation by pressing the  key.
- **Duty setting vs. maximum or minimum duties**
  - : Max. duty = Duty setting + (pulse width deviation [%] ÷ 2)
  - Min. duty = Duty setting – (pulse width deviation [%] ÷ 2)
- During sweep, multiple pulses may be produced within 1 period output as indicated in the figure.



- Setting items at pulse width modulation (MODU menu)
  - TYPE: PWM
  - DEVIATION (pulse width deviation) [%]
  - FREQ (modulation frequency) [Hz]
  - FUNCTION (modulation waveform) [SIN, , , , , ]

## 4.4 Arbitrary Waveform

### ■ Arbitrary waveform (ARB) ( → )

Operation using arbitrary waveform (ARB) to produce a sinewave with clipped peak output is described.

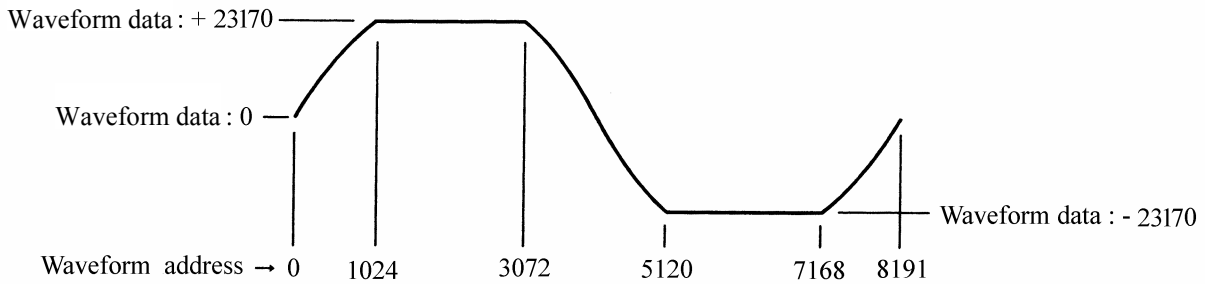

#### Operation:

##### (1) Set waveform to arbitrary (ARB)

① Press the  key, then the  key.

##### (2) Select an arbitrary waveform to be edited/output (SELECT).

① Press the  key, then use the  and  keys to produce the following display (SELECT flashes).

```

0 : ARB__00  1 : ARB__01  ▶
ARB : SELECT NAME EDIT COPY ▶
    
```



② Press the  key, then use the  and  keys to produce the following display (1:ARB\_01 flashes).

```

0 : ARB__00  1 : ARB__01  ▶
ARB : SELECT NAME EDIT COPY ▶
    
```

③ This completes the selection of an arbitrary waveform (No. 1 is selected here). Press the  key one time to release the arbitrary waveform selection mode.

**(3) Copy the waveform, for example, sinewave**

- ① Press the  key, then use the  and  keys to produce the following display (COPY flashes).





- ② Press  key, then use the  and  keys to produce the following display (SIN flashes).





- ③ Press  key to copy the sinewave.

**(4) Edit the waveform, for example, peak clip**

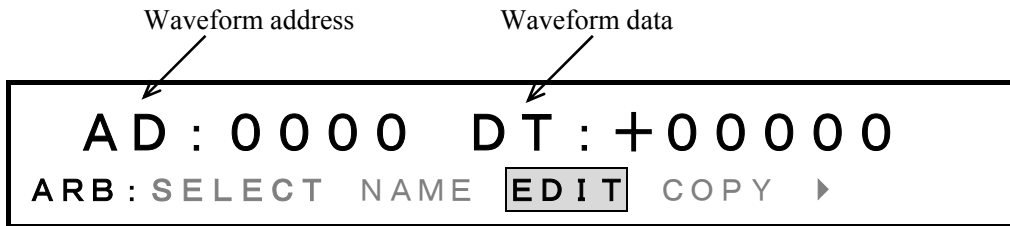
- ① Use the  and  keys to produce the following display (EDIT flashes).



- ② Press  key, then the  key (AD digit flashes).



- ③ Set the waveform address (AD) with the keypad or  dial.





For example, set to 1024.

- ④ Press the  key to produce the following display (the asterisk (\*) is displayed).



\* is interpolation type mark and indicates the linear interpolation type address. The mark appears and extinguishes each time the  key is pressed.

- ⑤ Next, use above steps ③ and ④ to set the interpolation mark (\*) to waveform address 3072.

- ⑥ Press the  key for linear interpolation. In this example, the first half of the sinewave is clipped (  ). The waveform data (DT) change as a result of linear interpolation between the starred addresses.
- ⑦ Press the  key, then use the  and  keys to produce the following display (MARK-CLEAR flashes).







Press the  key twice to clear the interpolation marks from addresses 1024 and 3072.

- ⑧ In the same manner as above steps ① to ⑥, clip the first half of a sinewave (set interpolation marks at 5120 and 7168).



The above completes arbitrary waveform setting.







**Other operations:**

- **Arbitrary waveform data input:**  → EDIT select →  →  flashes the waveform data (DT) digits. Use the keypad or  dial to set the data.





Data upper and lower limits are +32767 and -32768, which correspond to the amplitude peak-to-peak settings. For this reason, when the waveform vertical limits are changed by the above type of method, the amplitude setting (Vp-p) and the actual output waveform Vp-p do not coincide. The data set addresses are automatically the linear interpolation addresses (the \* mark is displayed).

- **Clear (to 0) waveform data:**  → CLEAR select → , then again press . The interpolation marks (\*) are also cleared.

- **Apply a name to an arbitrary waveform:**  → NAME select → , then use the  dial to select the characters. Shift position with  and , and input.



Up to 8 characters can be input. Following are the usable characters.

abcdefghijklmnopqrstuvwxyz ▾ (space)  
 ABCDEFGHIJKLMNOPQRSTUVWXYZ0123456789  
 !"#\$%&'()\*+,-./:;<=>@[¥]^\_`{|} → ←

- **Change the waveform data size:**  → SIZE select →  → Use  and  to select the data size

Relation between the waveform data size and number of waveforms



Data size	Waveform number												Number of waveforms
8K (8192)	0	1	2	3	4	5	6	7	8	9	10	11	12
16K (16384)	0		1		2		3		4		5		6
32K (32768)	0				1				2				3
64K (65536)	0												1

The output waveform changes as described below when the waveform data size is changed. If, for example, the waveform data size is changed from 16 KB to 8 KB when there is a waveform like  for waveform number 0,  is assigned to waveform number 0 and  to waveform number 1.





## 4.5 Selecting waveforms of synchronous signals (SYNC OUT)

This section describes the switching of SYNC OUT waveforms.

### ■ Procedure

- ① Press the  key, then use the  and  keys to produce the following display  
(The lower SYNC OUT flashes).



- ② Press the  key, then use the  and  keys to set the SYNC OUT waveform.
- ③ After setting, press the  key to release the SYNC OUT waveform setting mode.

### ■ When the oscillation mode is BURST

- STATE: Low level during oscillation. High level while stopped.
- PHASE: For  squarewaves (variable duty), the same waveform as that for FUNCTION OUT.  
For other cases, high level while between 0 and 180 degrees of the waveform in the oscillation period, and low level while between 180 and 360 degrees.

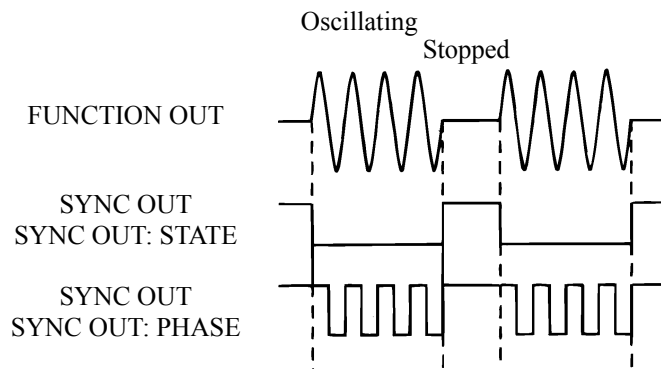

### ■ When the oscillation mode is SWEEP

- STATE: Low level while sweeping from the start value to the stop value or stopped. Otherwise, high level.
- PHASE: For  $\square$  squarewaves (variable duty), the same waveform as that for FUNCTION OUT. Otherwise, high level while between 0 and 180 degrees of the waveform, and low level while between 180 and 360 degrees.

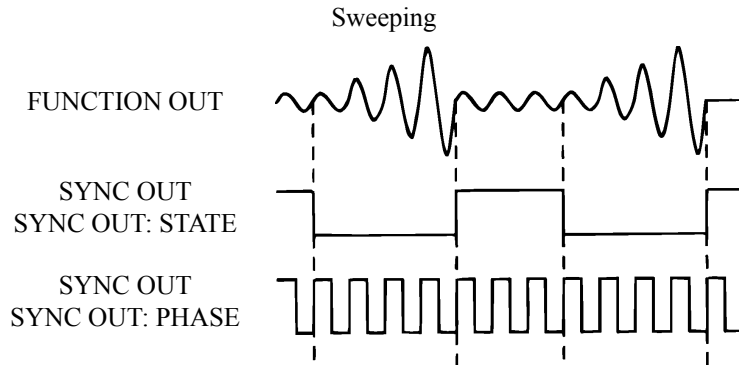

### ■ When the oscillation mode is MODU

- STATE: STATE: Low level while executing modulation and between 180 and 360 degrees of the modulated waves. Otherwise, high level.
- PHASE: For  $\square$  squarewaves (variable duty), the same waveform as that for FUNCTION OUT. Otherwise, high level while between 0 and 180 degrees of the modulated waves, and low level while between 180 and 360 degrees.

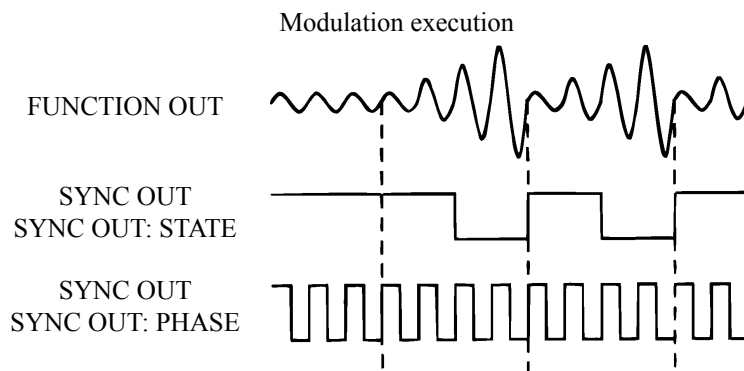

■ **Additional information:**

- For  $\sim$  and  $\square$  (fixed duty) at frequencies over 100 kHz, if SYNC OUT is set to PHASE, output becomes the waveform which applied the analog signal of a sinewave to the comparator. For this reason, the output level (high or low) may be undefined at 0, 180, and 360 degrees ( $\pm 2$  degrees, approximately).

In particular, note that when the oscillation mode is switched during a burst or gated sweep while oscillation is stopped, the output level may vary or the waveform may become glitch-shaped.

If a precise output level is required while oscillation is stopped, shift the phase setting. For example, setting the phase at + 90 degrees shifts the output level to the high level while oscillation is stopped.

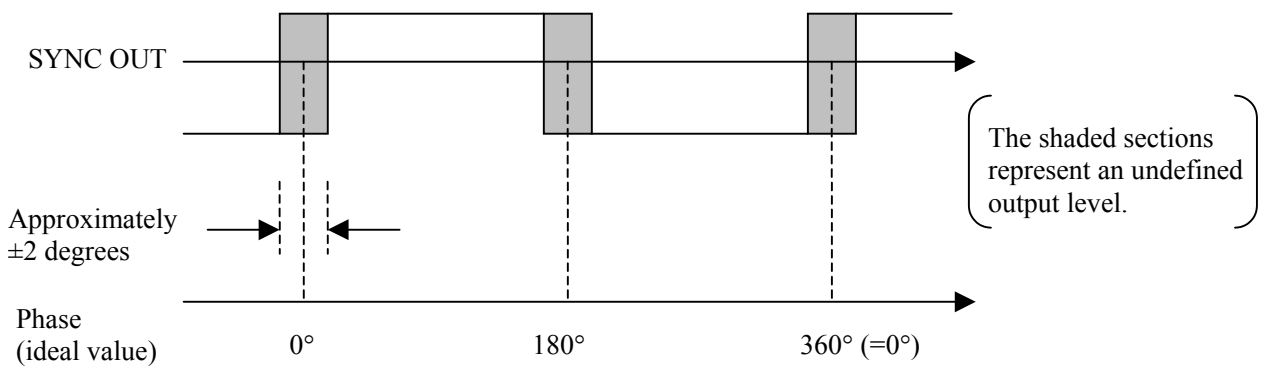

## 4.6 Output waveforms for sweeping and modulation

The setup values for sweeping and modulation are updated every 100 to 252  $\mu\text{s}$ . Thus, if the sweep time is short or the modulation frequency is high, the amount of change for updating increases, leading to marked discontinuities.

If the sweep function (modulated waves) is  $\square$ ,  $\nearrow$ , or  $\searrow$ , discontinuities become conspicuous in some of the stepwise variations.

Since the setup values vary enormously in some of the stepwise variations, discontinuities are generated. If such discontinuities are removed, the remaining variations have the appearance shown below.

If, as an extreme example, the oscillation frequency is 1 kHz, the sweep time is 4 ms, the start phase is 180 degrees, the stop phase is -180 degrees, and the sweep function is  $\nearrow$  in the phase sweep, the phase shifts about 26 degrees every 100  $\mu\text{s}$ , producing the following output waveforms. Discontinuities are generated not only by  $\searrow$ , but also by  $\swarrow$ ,  $\nearrow$ , and  $\searrow$ .

Since the phase changes at intervals of 100 to 252  $\mu\text{s}$ , discontinuities are generated

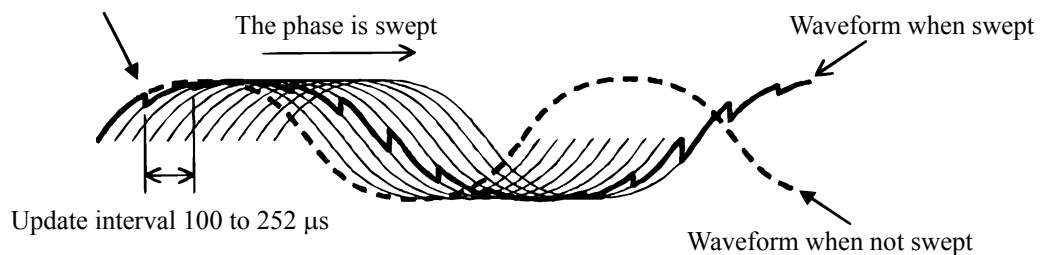

#### 4.6 Output waveforms for sweeping and modulation

Since the  $\square$  squarewaves (fixed duty) and  $\square$  squarewaves (variable duty) are generated differently from other waveforms, extra pulses are produced.

Similarly, extra pulses are also produced by phase modulation, duty sweep, and PWM.

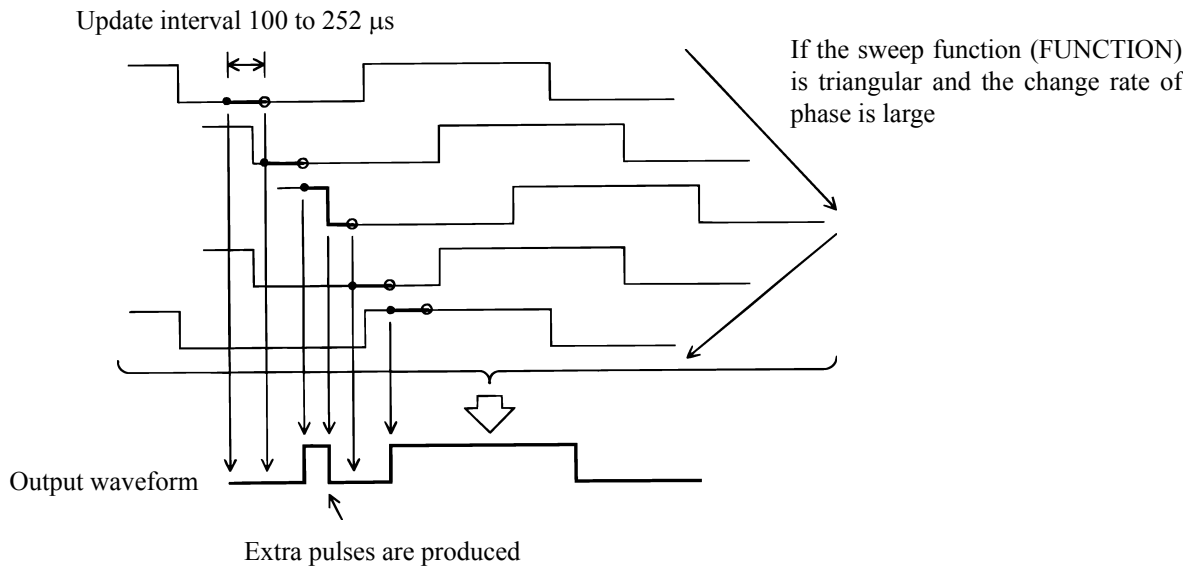

The occurrence frequency when the sweep function is  $\sim$ ,  $\simeq$ , or  $\nabla$  is roughly given by the following formula:

$$\text{Occurrence frequency [\%]} = \frac{\text{phase span [deg]}}{360 \times \text{oscillation frequency [Hz]} \times \text{sweep time [s]}} \times 100$$

If, for example, the frequency is 1 kHz, the phase span is 90 degrees, and the sweep time is 100 ms, an extra pulse is generated every 400 cycles on average.

## 4.7 Equivalent noise bandwidth

The density of noise generated by the WF1945B is as shown in the following figure (a) "Frequency characteristics of noise generated by the WF1945B."

The effective values (rms) of (a) are equal to those of white noise in the figure (b) "Frequency characteristics of white noise," that follows. This equivalent bandwidth (500 kHz) is called the equivalent noise bandwidth.

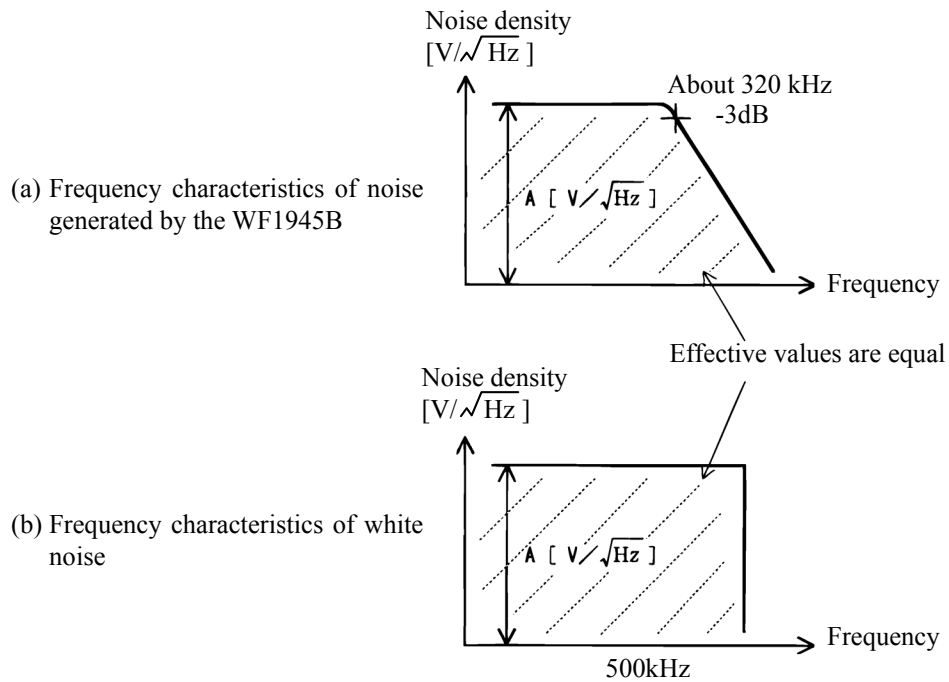





## Section 5 Other Operations

5.1	Convenient Settings .....	5-2
	■ Frequency [Hz] setting by period [s] .....	5-2
	■ Squarewave duty setting .....	5-3
	■ Squarewave pulse width setting .....	5-4
	■ Amplitude and DC offset setting by high and low level .....	5-5
5.2	Units .....	5-7
	■ Engineering unit ( $\mu$ , m, k, M) display .....	5-7
	■ Amplitude units change .....	5-8
	■ User-unit setting .....	5-9
5.3	Setting memory .....	5-13
	■ Setting store .....	5-13
	■ Setting recall .....	5-14
	■ Setting memory clear .....	5-15
5.4	External Input .....	5-16
	■ External add (EXT-ADD) .....	5-16
	■ External AM (EXT-AM) .....	5-17
5.5	Other settings .....	5-18
	■ Output range change (use with fixed range) .....	5-18
	■ Output on/off at power on .....	5-19
	■ LOAD function (equalize setting and output values) .....	5-20
	■ UNDO function .....	5-21
	■ Pulse generator function .....	5-22
	■ Phase sync .....	5-24

• Following is a typical example of the display panel indications used in this Section.

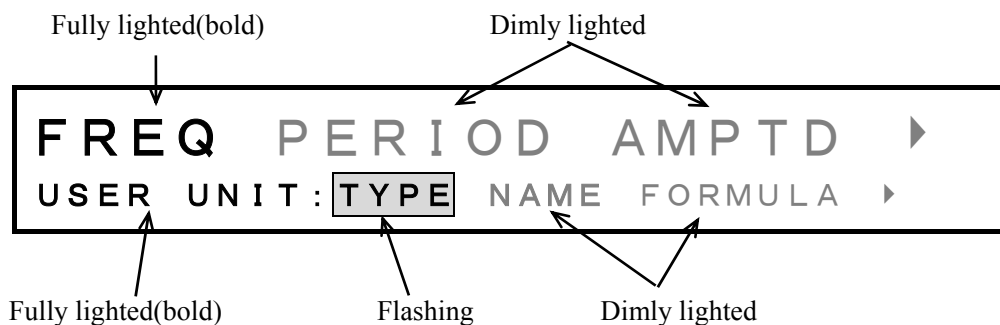

## 5.1 Convenient Settings

### ■ Frequency [Hz] setting by period [s] ( → )

Operation is described for setting the waveform repetition rate not in frequency (Hz) but as period (s).

#### Operation:

- ① Press the  key, then the  key to produce the following display.

<b>P</b>	<b>0 . 0 0 1 0 0 0 0 0 0 0 0 0</b>	<b>S</b>
<b>A 0 . 1 0 0 0 V p - p</b>	<b>0 + 0 . 0 0 0 0 V</b>	<b>/ O P E N</b>

- ② Set the period with the keypad or  dial.

#### Other:

The period setting is frequency with the reciprocal less than 0.01  $\mu\text{Hz}$ , the number should be rounded off. Thus, the setting tolerance is large when the frequency setting digits are fewer (period longer).

In this situation, even if setting is changed by the keypad or  dial, the actual oscillation period does not change in some cases.

## ■ Squarewave duty setting ( $\text{ENTRY} \rightarrow \text{DUTY}$ )

Operation to set the squarewave duty is described. The setting changes the width (%) of the pulse with respect to the overall waveform (  $\text{F}$  portion indicated by arrows).

Select squarewave (  $\text{F}$  variable duty).

### Operation:

- ① Press the  $\text{ENTRY}$  key, then the  $\text{DUTY}$  key to produce the following display.

<b>DUTY</b>	<b>50.0000 %</b>
<b>1000.000000Hz</b>	<b>A0.1000Vp-p/OPEN</b>

- ② Set the duty with the keypad or  $\text{MODIFY}$  dial.



### Other:

- The table indicates the effects on other parameters when the frequency, period, width or duty is changed.

Change ↓	Frequency (FREQ)	Period (PERIOD)	Pulse width (WIDTH)	Duty (DUTY)
Frequency (FREQ)		Changed	Changed	Unchanged
Period (PERIOD)	Changed		Unchanged	Changed
Pulse width (WIDTH)	Unchanged	Unchanged		Changed
Duty (DUTY)	Unchanged	Unchanged	Changed	

- Due to the oscillation period and duty relationship, the pulse can be lost when the actual pulse width is less than 25 ns. An error message is displayed at this type of setting. Also, jitter increases when the pulse width is less than 100 ns. A warning message is displayed at this type of setting.
- The actual waveform duty resolution is [oscillation frequency] ÷ [approx. 40 MHz] (0.00001 % at minimum). When the stop level is on, the minimum actual waveform duty resolution is approximately 0.003 %.
- For other notes, see "■ Waveform selection" in Section 3.3, "Basic operation."

■ **Squarewave pulse width setting** (  →  )

Operation to set the squarewave pulse width is described. The setting changes the width of the pulse (portion indicated by arrows  ).

Select squarewave (  variable duty).

**Operation:**

- ① Press the  key, then the  key to produce the following display.

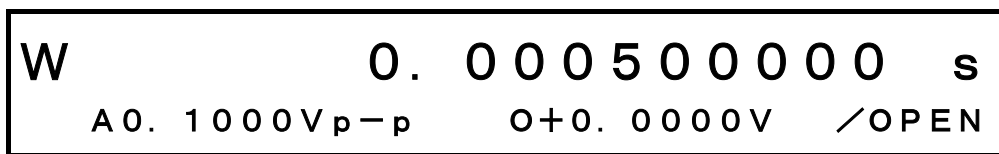

- ② Set the width with the keypad or  dial.

**Other:**

- The table indicates the effects on other parameters when the frequency, period, width or duty is changed.

Change ↓	Frequency (FREQ)	Period (PERIOD)	Pulse width (WIDTH)	Duty (DUTY)
Frequency (FREQ)		Changed	Changed	Unchanged
Period (PERIOD)	Changed		Unchanged	Changed
Pulse width (WIDTH)	Unchanged	Unchanged		Changed
Duty (DUTY)	Unchanged	Unchanged	Changed	

- Due to the oscillation period and duty relationship, the pulse can be lost when the actual pulse width is less than 25 ns. An error message is displayed at this type of setting.  
Also, jitter increases when the pulse width is less than 100 ns. A warning message is displayed at this type of setting.

## ■ Amplitude and DC offset setting by high and low level ( → / )

Operation to set the waveform vertical size as high and low level, in place of amplitude and DC offset, is described.

Select the waveform type for squarewave.

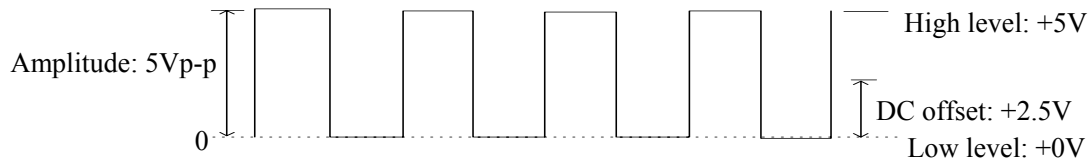

### Operation:

- ① Press the  key, then the  key to produce the following display.

<b>H I G H</b>	<b>+0. 0500 V</b>	
<b>1 0 0 0 . 0 0 0 0 0 0 0 H z</b>	<b>L - 0 . 0 5 0 0 V</b>	<b>/ O P E N</b>

- ② Set the High level with the keypad or  dial.

For example, set to +5 V.

- ③ Press the  key, then the  key to produce the following display.

<b>L O W</b>	<b>-0. 0500 V</b>	
<b>1 0 0 0 . 0 0 0 0 0 0 0 H z</b>	<b>H + 5 . 0 0 0 0 V</b>	<b>/ O P E N</b>

- ④ Set the Low level with the keypad or  dial.

For example, set to +0 V.

## 5.1 Convenient Settings

---

### Other:

The table indicates the effects on other parameters when the amplitude, DC offset, high level or low level is changed

Change ↓	Amplitude (AMPTD)	DC offset (OFFSET)	High level (HIGH)	Low level (LOW)
Amplitude (AMPTD)		Unchanged	Changed	Changed
DC offset (OFFSET)	Unchanged		Changed	Changed
High level (HIGH)	Changed	Changed		Unchanged
Low level (LOW)	Changed	Changed	Unchanged	

- Due to the relationships between high and low level settings, relationship between amplitude and DC offset settings, or the setting of the external addition and external AM, when the output voltage exceeds the following values, the Over lamp flashes and the output is clipped in some cases.

10 V range: Approx. 11 V peak/open time

1 V range: Approx. 1.1 V peak/open time

## 5.2 Units

### ■ Engineering unit ( $\mu$ , m, k, M) display

Operation is described for displaying engineering units (e.g., the k of 1 kHz). As an example, the frequency units are changed.

#### Operation:

- ① Press the  key, then the  key.

1 0 0 0 . 0 0 0 0 0 0 0 0 H z
A 0 . 1 0 0 0 V p - p    0 + 0 . 0 0 0 0 V    / O P E N

- ② Press the  key to change the display as follows.

1 . 0 0 0 0 0 0 0 0 0 0 0 0 k H z
A 0 . 1 0 0 0 V p - p    0 + 0 . 0 0 0 0 V    / O P E N



#### Other:

- **Unit change enable:** Only when the  ,  ,  or  key is lighted.
- **Initializing units (e.g., from kHz to Hz):** At above step②, press the  key.

## ■ Amplitude units change

Operation to change the amplitude units is described. For example, set to Vrms.

### Operation:

- ① Press the  key, then the  key.
- ② Press the  key to produce the following display (Vp-p lights).

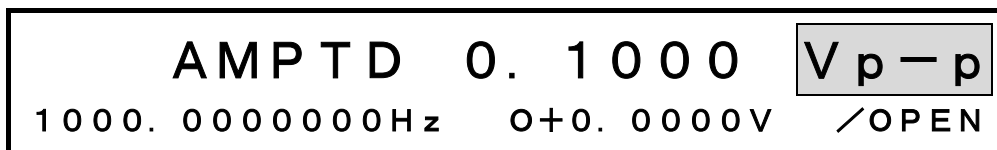

- ③ Turn the  dial to produce the following display.

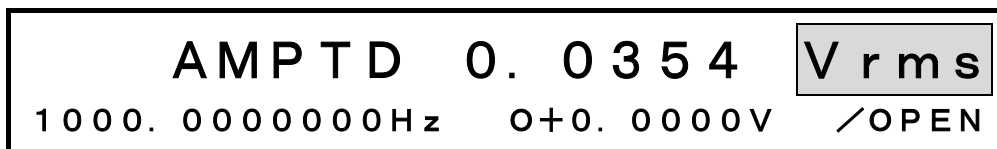

### Other:

- The following units can be used.
  - Vp-p, Vrms, dBV, dBm (\*1), USER (\*2)
  - \*1: Selectable when LOAD function is SET.
  - \*2: Set User units name is displayed.
- Notes: Only Vp-p and USER can be selected when the oscillation mode is NOISE.  
Only Vp-p and USER can be selected when the selected waveform is ARB.
- Even if the amplitude units are changed, the actual output voltage does not change.





## ■ User-unit setting ( → USER-UNIT)

Operation for changing the units by using the user unit function is described.

For example, set for expressing frequency as rpm (revolutions per minute, e.g., engine rotation).

### Operation:

#### (1) Select setting type, for example, frequency

- ① Press the  key, then use the  and  keys to produce the following display (USER-UNIT flashes).



```

USER UNIT MENU
SYSTEM: RANGE PRESET USER-UNIT ▶
  
```

- ② Press the  key, then use the  and  keys to produce the following display (TYPE flashes).

```

FREQ PERIOD AMPTD ▶
USER UNIT: TYPE NAME FORMULA ▶
  
```



- ③ Again press the  key, then use the  and  keys to produce the following display (FREQ flashes).

```





FREQ PERIOD AMPTD ▶
USER UNIT: TYPE NAME FORMULA ▶
  
```

- ④ This selects the setting type to frequency. Press the  key once to release the type select mode.

**(2) Set the unit NAME (e.g., rpm)**

- ① Use the  and  keys to produce the following display (NAME flashes).



**USER**  
 USER UNIT: TYPE **NAME** FORMULA ▶

- ② Press the  key, then use the  dial and  and  keys to input the unit name (e.g., rpm). Up to 4 of the following characters can be used for the unit name.



abcdefghijklmnopqrstuvwxyz ▾ (space)  
 ABCDEFGHIJKLMNOPQRSTUVWXYZ0123456789  
 !"#%&'()\*+,-./:;<=>@[¥]^\_`{|}→←

- ③ After inputting, press the  key once to release unit name setting.

**(3) Select the FORMULA, for example, (h+n)\*m. The setting type (e.g., frequency) is h, n is offset, and m is the coefficient.**

- ① Use the  and  keys to produce the following display (FORMULA flashes).



**(h+n) \* m** (Log (h) + n) \* m  
 USER UNIT: TYPE NAME **FORMULA** ▶

- ② Press the  key, then use the  and  keys to produce the following display [(h+n)\*m flash].

**(h+n) \* m** (Log (h) + n) \* m  
 USER UNIT: TYPE NAME FORMULA ▶



- ③ This sets the formula to (h+n)\*m. Press the  key once to release the formula setting mode.

**(4) Set the coefficient [SCALE (m)], e.g., to 60**

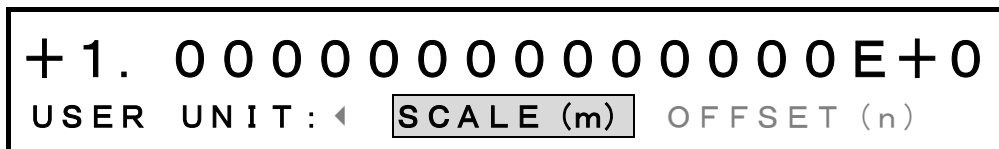

- ① Use the  and  keys to produce the following display (SCALE (m) flashes).



The display shows: **+ 1. 0000000000000000E+0**  
 USER UNIT: ◀ **SCALE (m)** OFFSET (n)



- ② Press the  key, then set the scale with the keypad or  dial.
- ③ Press the  key to release the scale setting mode.

**(5) Set the offset [OFFSET (n)], for example, to 0**



- ① Use the  and  keys to produce the following display [OFFSET (n) flashes].



The display shows: **+ 0. 0000000000000000E+0**  
 USER UNIT: ◀ SCALE (m) **OFFSET (n)**

- ② Press the  key, then set the offset with the keypad or  dial.
- ③ Press the  key to release the offset setting mode.

**(6) Display the above settings**

- ① Press the  key, then the  key.
- ② Press the  key to produce the following display (Hz flashes).

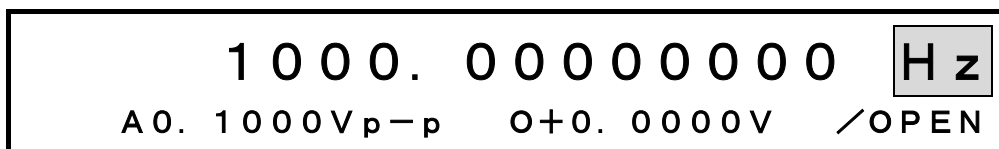

The display shows: **1000. 00000000 Hz**  
 A0. 1000V p-p O+0. 0000V /OPEN

- ③ Turn the  dial to produce the following display.

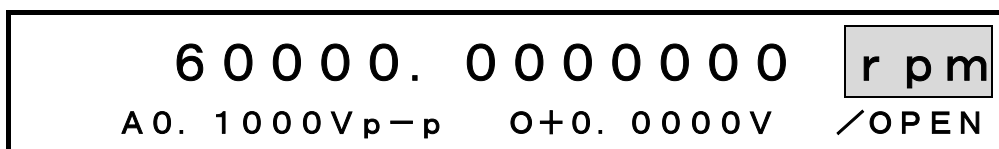

The display shows: **60000. 00000000 rpm**  
 A0. 1000V p-p O+0. 0000V /OPEN

**Other:**

- User units can be used for frequency, period, amplitude, DC offset, phase and duty.
- Even when user units are set, the actual output does not change.
- According to the coefficient and offset settings, setting resolution may be less precise when user units are used.
- When using user units for the DC offset and phase in LOG selection, note the following.

If a negative value is set before the conversion to user units is made, an attempt is made to calculate the logarithm of a negative value. Since the logarithm of a negative value cannot be a real number, "OVER" is displayed.

Thereafter, user setup values can be arbitrarily changed. However, the DC offset and phase cannot be converted to a negative value while user units are being used.

## 5.3 Setting memory

### ■ Setting store ( : STORE)

Operation is described for saving frequency, amplitude and other settings in memory.

#### Operation:

- ① Press the  key, then use the  and  keys to produce the following display (STORE flashes).

```
STORE MENU
MEMORY : STORE  RECALL  CLEAR
```

- ② Press the  key, then use the  and  keys to produce the following display (0 flashes).

```
(NOT STORED)
STORE : 0  1  2  3  4  5  6  7  8  9
```

- ③ Press the  key, then apply a desired name to the memory (may also be omitted). Select characters with the  dial and shift position with the  and  keys. Up to 20 characters can be selected from the following list.

```
abcdefghijklmnopqrstuvwxyz ▾ (space)
ABCDEFGHIJKLMNOPQRSTUVWXYZ0123456789
!"#$%&'()*+,-./:;<=>@[¥]^_`{|} → ←
```

- ④ Press the  key to store the name (in this example, save to memory 0).

The above completes memory storage. Press the  key to release the storage mode.



#### Other:

- By pressing the keypad at above step ②, name input is omitted and storage is at the memory of the depressed number.



## ■ Setting recall ( : RECALL)

Operation to recall settings from memory is described.

### Operation:

- ① Press the  key, then use the  and  keys to produce the following display (RECALL flashes).



- ② Press the  key, then use the  and  keys to produce the following display (0 flashes). In this example, TEST 1 is recalled from memory.



- ③ Press  key for recall.

### Other:

- If the keypad is pressed at above step ②, the pressed memory number is recalled. Only the stored numbers of the keypad light.
- Items stored in the setting memory and user unit settings are noted in Section [3.3 Basic operation, Setting initialize]. The following items do not change before and after recall.
  - Output on/off
  - Output on/off state at power on
  - Arbitrary waveform parameter
  - Type of remote control
  - GPIB parameter
  - USB ID



## ■ Setting memory clear ( : CLEAR)

Operation to clear the memory is described. The operation also clears names entered in the memory.

### Operation:

- ① Press the  key then use the  and  keys to produce the following display (CLEAR flashes).



- ② Press the  key, then use the  and  keys to produce the following display (0 flashes). In this example, TEST 1 is cleared from memory.

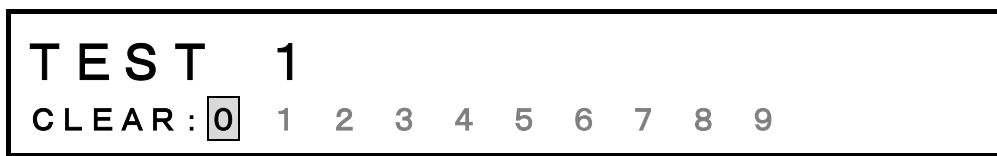

- ③ Press  key to clear the memory recall.

### Other:

- At above step ②, pressing the keypad clears the corresponding memory number. Only the stored numbers of the keypad light.

## 5.4 External Input

### ■ External add (EXT-ADD) ( <sup>SYSTEM</sup> : EXT-ADD)

Operation is described for adding an external signal to the WF1945B output. The external signal is connected to the rear panel EXT ADD IN connector. Refer to **External add input (EXT ADD IN)** on page 28.

#### Operation:

- ① Press the <sup>SYSTEM</sup> key, then use the  and  keys to produce the following display (EXT-ADD flashes).



The LCD display shows two lines of text. The top line contains "OFF" and "ON". The bottom line contains "SYSTEM: ◀ LOAD EXT-AM EXT-ADD ▶". The "EXT-ADD" text is highlighted with a grey background.

- ② Press the  key, then use the  and  keys to produce the following display (ON flashes).



The LCD display shows two lines of text. The top line contains "OFF" and "ON". The bottom line contains "SYSTEM: ◀ LOAD EXT-AM EXT-ADD ▶". The "ON" text is highlighted with a grey background.



## ■ External AM (EXT-AM) ( <sup>SYSTEM</sup> : EXT-AM)

Operation to modulate the WF1945B output with an external AM signal is described. The external signal is applied to the rear panel EXT AM IN connector.

 For details on connectors, “3.2 Input and output connectors (■External add input (EXT ADD IN))”, cf.

### Operation:

- ① Press the <sup>SYSTEM</sup> key, then use the  and  keys to produce the following display (EXT-AM flashes).

```

OFF ON
SYSTEM: ◀ LOAD EXT-AM EXT-ADD ▶
  
```

- ② Press the <sup>ENTER</sup> key, then use the  and  keys to produce the following display (ON flashes).

```

OFF ON
SYSTEM: ◀ LOAD EXT-AM EXT-ADD ▶
  
```

### Note:

- AM appears at the head of the display when external AM is on.

```

1000.00000000Hz
AM A0. 1000Vp-p 0+0.0000V /OPEN
  
```

## 5.5 Other settings



### ■ Output range change (use with fixed range) ( : RANGE)

Operation is described for fixing the voltage output range to 10 V.

Although AUTO is normally used, by fixing the range, output interruption from automatic switching can be avoided.

A disadvantage is during output voltage below 2 Vp-p (open), setting resolution is 1 digit less than the 1 V range.

#### Operation:

- ① Press the  key, then use the  and  keys to produce the following display (RANGE flashes).



AUTO 10V 1V  
SYSTEM: RANGE PRESET USER-UNIT ▶

- ② Press the  key, then use the  and  keys to produce the following display (10 V flashes).



AUTO 10V 1V  
SYSTEM: RANGE PRESET USER-UNIT ▶

#### Other:

- If the output range is set as 1 V when the amplitude setting is larger than 2 Vp-p (open), the amplitude is automatically changed to 1/10 since voltage exceeding 2 Vp-p (open) cannot be output in the 1 V range.

## ■ Output on/off at power on ( <sup>SYSTEM</sup> : POWER - ON)

Selectable return to the state when the power supply was switched off or output on/off state. The example is setting the output for off at power on.

### Operation:

- ① Press the <sup>SYSTEM</sup> key, then use the  and  keys to produce the following display (POWER-ON flashes).

```

LAST-STATE  OFF  ON
SYSTEM: ◀  SYNCOUT  POWER-ON ▶
  
```

- ② Press the  key, then use the  and  keys to produce the following display (OFF flashes).

```

LAST-STATE  OFF  ON
SYSTEM: ◀  SYNCOUT  POWER-ON ▶
  
```

## ■ LOAD function (equalize setting and output values) ( <sup>SYSTEM</sup> : LOAD)

Operation is described for equalizing the amplitude (AMPTD) and DC offset (OFFSET) setting values with the actual output values (FUNCTION OUT connector voltage).

The example is setting at the 100Ω load impedance.

### Operation:

- ① Press the <sup>SYSTEM</sup> key, then use the  and  keys to produce the following display (LOAD flashes).



- ② Press the  key, then turn the <sup>MODIFY</sup> dial to produce the following display (SET flashes).



- ③ Press the  key, then turn the <sup>MODIFY</sup> dial to set the load impedance to 100 Ω.

The above setting calculates the actual voltage of FUNCTION OUT connector from the WF1945B output impedance (50 Ω) and the load impedance for automatically changing the indicated value.

### Other:

- The load impedance setting range is 45 to 999 Ω, resolution is 1 Ω.
- The WF1945B output impedance and voltage errors are not converted.

## ■ UNDO function

The UNDO function is described for returning a numerical or other setting to the previous state.

### Operation:

- ① Press the  to return a setting to the previous state (ineffective when UNDO is extinguished).

### Other:

- Undo enabled:

1. Directly after changing frequency, amplitude, etc., with the keypad or MODIFY dial.
2. Directly after setting recall (  → RECALL). Press the  key to return the state prior to recall.

## ■ Pulse generator function

Operation of the WF1945B as a pulse generator is described.

### Operation:

#### (1) Set for continuous pulse output

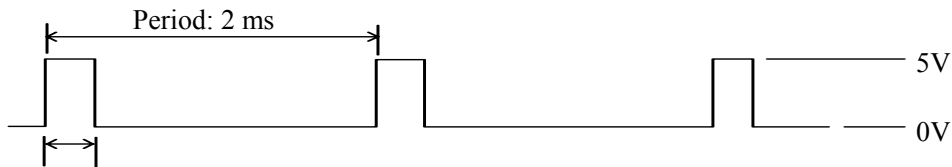







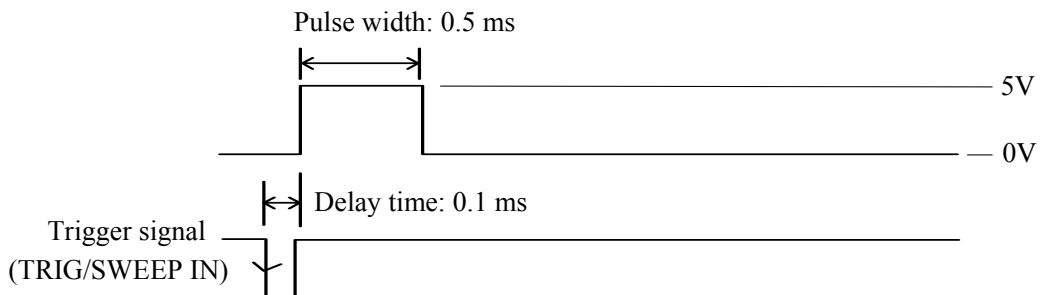

Pulse width: 0.2 ms

- ① Set the waveform to squarewave (variable duty), (  →  ).
- ② Set the voltage High level to +5 V and the Low level to 0 V.  
(  →  HIGH →  5 →  ENTER ,  →  LOW →  0 →  ENTER )
- ③ Set the period to 2 ms (  →  PERIOD →  2 →  m ).
- ④ Set the pulse width to 0.2 ms (  →  WIDTH →  . →  2 →  m ).



#### (2) Use external trigger for pulse output



- ① Set the waveform to squarewave (variable duty), (  →  ).
- ② Set the voltage High level to +5 V and the Low level to 0 V.  
(  →  HIGH →  5 →  ENTER ,  →  LOW →  0 →  ENTER )

- ③ Set the pulse width to 0.5 ms (  →  →  →  →  ).
- ④ Set oscillation mode.  
 (  →  → TYPE = TRIG, SOURCE = EXT  , DELAY = 0.1 ms,  
 MARK = 1.0 cycle, STOP-LEVEL = ON -100%)
- ⑤ Apply the trigger signal to the TRIG/SWEEP IN connector.

**Other:**

- **Double pulse output:** At above step ④, set MARK = 2.0 cycles.
- **Manual trigger:** At above step ④, set SOURCE = EXT  and press the  key.  
 (Do not connect anything to the TRIG/SWEEP IN connector.)

## ■ Phase sync ( SYSTEM : $\phi$ SYNC )

Operation is described for restarting the output waveform from a set phase so as to clarify the phase relationship.

The function uses  $\phi$ -SYNC IN, OUT (1991 synchronous operation option) to synchronize the operation of multiple units.

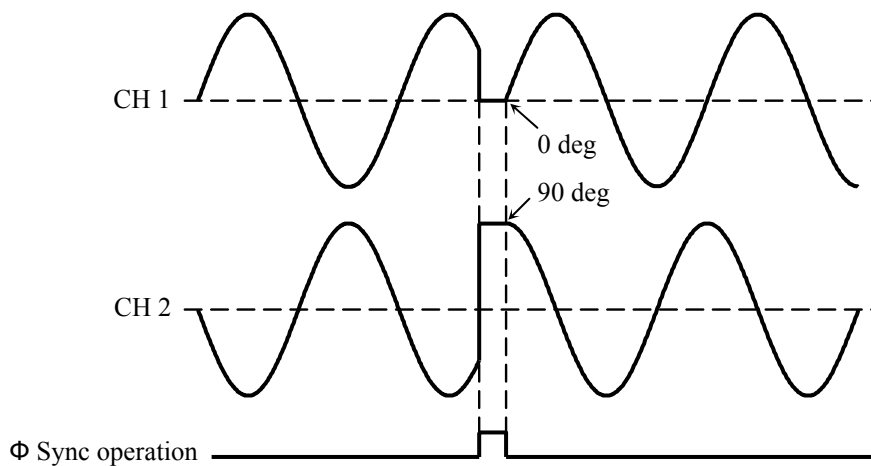

Phase sync operation and waveform outputs of 1st and 2nd units (1st unit phase 0 degrees, 2nd unit phase 90 degrees)

### Operation:

- Press the  SYSTEM key, then use the  and  keys to produce the following display ( $\phi$  SYNC flashes).



- Press the  ENTER key to engage phase synchronization.

### Other:

- $\phi$  sync is effective in Normal oscillation mode. In other modes, the phase may shift 180 degrees and the values of the mark cycle and space cycle settings may change.
- The phase between outputs of units (channels) in synchronous operation is the difference between the phase settings (PHASE) set for each unit (channel).



## Section 6 Troubleshooting

6.1 Error message .....	6-2
■ Power on error .....	6-2
■ Operation error .....	6-3
6.2 Suspected failure .....	6-5
■ In case of abnormality .....	6-5

## 6.1 Error message

Self-check is conducted at power on and in case of an abnormality, an error message is displayed. An error message is also displayed if an erroneous operation is conducted.

Error message contents, causes and corrective measures are indicated in the following tables.

### ■ Power on error

<b>Error message</b>	<b>Cause</b>	<b>Corrective measures</b>
<b>BACKUP MEMORY LOST</b>	Battery backup memory contents destroyed.	Backup battery probably depleted. Contact dealer. Press the ENTER key to start the system at the factory settings.
<b>CALIBRATION MEMORY LOST</b>	Calibration data destroyed.	Contact dealer. Although possible to start by pressing the ENTER key, accuracy cannot be guaranteed.
<b>SYSTEM TEST FAILED 001</b>	Internal ROM sum check error.	Contact dealer.
<b>SYSTEM TEST FAILED 002</b>	Internal RAM read/write error.	Contact dealer.

■ **Operation error**

<b>Error message</b>	<b>Cause or corrective measures</b>
<b>DATA OUT OF RANGE</b>	Input values outside of permissible setting range. Confirm permissible setting range and again input. Upper and lower limits can be easily checked by using the MODIFY dial to change the values.
<b>INVALID NUMERIC DATA</b>	Keypad input data invalid (e.g., decimal point only).
<b>SETTINGS CONFLICT 001</b>	Start or stop value set to 0 during LOG sweep and sweep cannot be executed.
<b>SETTINGS CONFLICT 002</b>	Combined center and span exceed the permissible sweep type (e.g., frequency) setting range.
<b>SETTINGS CONFLICT 003</b>	Combined modulation type (e.g., frequency) and Deviation or DEPTH exceed the permissible modulation type setting range and modulation cannot be executed.
<b>SETTINGS CONFLICT 004</b>	Combined modulation type (e.g., frequency) and Deviation or DEPTH exceed the permissible modulation type setting range.
<b>SETTINGS CONFLICT 007</b>	Combined period and pulse width exceed the permissible duty setting range.
<b>SETTINGS CONFLICT 010</b>	Since the mode is SWEEP or MODU for $\square$ (variable duty), DUTY VALID cannot be set.
<b>STORE/RECALL MEMORY LOST</b>	Setting storage memory contents destroyed and settings cannot be recalled. Contact dealer.

continued next page

continued from previous page

<b>Error message</b>	<b>Cause or corrective measures</b>
<b>WARNING 001</b>	Combined frequency and duty set the pulse width to not more than 25 ns and the pulse may be lost.
<b>WARNING 002</b>	Combined frequency and duty set the pulse width to 25 and 100 ns and pulse width may be unstable (large jitter component).
<b>WARNING 003</b>	Since high frequency, burst oscillation mark and space may be unstable.
<b>WARNING 004</b>	Low level setting changed due to high level setting change, or conversely, high level setting changed due to low level setting change.
<b>WARNING 005</b>	Changed to simple standard units (Hz, s, Vp-p, V).
<b>WARNING 006</b>	Since combined period and pulse width exceed the permissible duty setting range, pulse width was changed in order to enter the permissible duty range.
<b>WARNING 015</b>	Because of DUTY VALID change, the duty was changed to 0.01% or 99.99%.
<b>WARNING 016</b>	Because of a mode change, DUTY VALID was changed to IMMED.

## 6.2 Suspected failure

### ■ In case of abnormality

If an abnormality is suspected, check as indicated in the following table. If normal operation cannot be returned, contact the dealer.

Symptom	Possible causes	Correction
<b>No power on</b>	Power source not within specified range	Use the power source within the specified range.
	Power supply fuse open	Replace the power supply fuse. (Be sure to use the correctly rated fuse.)
	External noise	Install the equipment in a site with favorable conditions.
<b>Panel inoperative</b>	Remote mode enabled	Press the LOCAL key to set the local mode.
	Keys or Modify dial defective	Contact service.
<b>Output abnormal</b>	Ambient temperature and humidity outside specified range	Use the equipment under the specified environmental conditions.
	Inadequate warm up	Allow the equipment to warm up for at least 30 minutes after power on.
	DC offset applied	Set DC offset to 0 V.
	External AM on	Set external AM off.
	Set for user units	Select standard units
	LOAD function being used	Set for OPEN.
<b>Cannot be set via remote control</b>	Address or USB ID different from that in the program	Set the address and USB ID to match those in the program.
	Address or USB ID identical to that of another device	Set the address and USB ID so that they do not match those of other devices.
<b>Does not operate according to instruction manual</b>	Settings have been initialized (PRESET).	The instruction manual presumes the settings have been initialized.



## Section 7 Maintenance

7.1	Outline	7-2
■	Work contents	7-2
■	Required test instruments	7-2
7.2	Operation checks	7-3
■	Preparatory checks	7-3
■	Function checks	7-3
7.3	Performance tests	7-5
■	Performance tests	7-5
■	Preparatory checks	7-5
■	Test preparation	7-5
■	Frequency accuracy	7-5
■	Amplitude accuracy	7-6
■	DC offset accuracy	7-6
■	Amplitude vs. frequency characteristics	7-7
■	Sinewave distortion	7-7
■	Squarewave response	7-8
■	Duty factor	7-8

## 7.1 Outline

### ■ Work contents

The following types of maintenance are required in order to use the equipment in optimum condition.

- Inspection Check that the equipment is operating correctly.
- Performance tests Check that the equipment meets specifications.
- Adjustment and calibration When the equipment does not meet specifications, it is adjusted and calibrated in order to restore performance at the manufacturer.
- Service Cause and location of failure are investigated and repair is conducted at the company.

This instruction manual provides easily carried out procedures for inspection and performance checks. Consult the manufacturer or dealer regarding more thorough inspection, adjustment, calibration and repair.

### WARNING

**Do not remove external covers.**

**Internal inspection of this equipment must be performed only by a trained service technician who is fully aware of the hazards involved.**

### ■ Required test instruments

The following equipment is required for inspection and performance tests.

- Oscilloscope At least 100 MHz bandwidth
- Universal counter Reference oscillator accuracy better than  $5 \times 10^{-7}$
- DC voltmeter Accuracy better than 0.1 %
- AC voltmeter 1 True rms, accuracy better than 0.3 %, bandwidth at least 100kHz, recommended: Keithley Model 2001
- AC voltmeter 2 True rms, accuracy better than 1 %, bandwidth at least 20MHz, recommended: Boonton Model 9200C+952016+952002
- Distortion meter Full scale 0.1 %, frequency up to 100 kHz
- 50  $\Omega$  feed through terminator
- 50  $\Omega$  20 dB attenuator



## 7.2 Operation checks

### ■ Preparatory checks

Check the following before inspection.

- Power source voltage is within specified range.
- Ambient temperature is within 5 to 35 °C.
- Ambient relative humidity is within 10 to 85 %RH (absolute humidity: 1 to 25 g/m<sup>3</sup>)
- Condensation is absent.

### ■ Function checks

- Power on

Confirm absence of error message at power on.

If an error message appears,  “6. Troubleshooting”, cf.

















If an abnormal indication appears at power on, switch power off and wait at least 5 seconds, then again switch power on.

- Main function checks

To avoid setting error, initialize the settings (  → PRESET).

Connect FUNCTION OUT to an oscilloscope with 50 Ω coaxial cable to monitor the output.

Operate to change the following settings several times and confirm normal functions. Test both keypad and MODIFY dial for settings such as frequency.

- Frequency (  →  )
- Amplitude (  →  )
- DC offset (  →  )
- Waveform (  →  ,  ,  Duty fixed 50 % ,  ,  )
- Duty (  →  Variable duty,  →  )
- Output on/off (  )

- Backup function

Switch off the power, wait at least 5 seconds, then switch the power on.

Confirm the settings for the following items prior to switching off the power have been correctly saved.

- Frequency
- Amplitude
- DC offset
- Waveform
- Duty

If stored at room temperature, the backup period is typically 3 years, but may vary among individual units and usage conditions.

To prevent any loss of setting information resulting from a depleted battery, regular battery replacement is recommended.

- GPIB/USB

Conduct some of the main function checks via GPIB/USB and confirm the same output variations.

Also note that the remote (REM) indicator lights.

Press the LOCAL key and confirm the remote indicator extinguishes and the local mode is returned (not local lock out).

## 7.3 Performance tests

### ■ Performance tests

Performance tests are an important part of preventive maintenance and serve to prevent serious deterioration of the equipment performance.

Conduct these tests at incoming inspection, routine inspection, following repair and whenever performance needs to be confirmed.

When specifications are not met in performance tests, service is required. Contact the dealer.

### ■ Preparatory checks

Check the following before testing performance.

- Power source voltage is within specified range.
- Ambient temperature is  $23 \pm 5$  °C.
- Ambient relative humidity is within 20 to 70 % RH.
- Condensation is absent.
- Allow at least 30 minutes warm up.

### ■ Test preparation

- Signal cables are 50  $\Omega$  coaxial, RG-58A/U or thicker, less than 1 meter length and fitted at both ends with BNC connectors.
- Where items call for 50  $\Omega$  termination, set the input impedance of the connected instrument to 50  $\Omega$ . Where this is impossible, use a 50  $\Omega$  feed through terminator at the test instrument input.
- Initialize the settings for each test item (  <sup>SYSTEM</sup> → [PRESET]), set the output on (key internal LED lights according to  <sup>OUTPUT</sup> / ON/OFF ) and the item to be changed is indicated.

### ■ Frequency accuracy

Connection: Use coaxial cable to connect FUNCTION OUT to a universal counter (50  $\Omega$  termination).

Setting: Initialize, then set frequency to 1 MHz and amplitude to 20 Vp-p/open.







Measurement: Measure frequency with the universal counter.

Judgment: Normal if within  $\pm 5$  ppm (999.995 to 1.000005 MHz) (when shipped)

However, since aging may occur with up to  $\pm 3$  ppm/year, deterioration up to  $\pm 8$  ppm (999.992 to 1.000008 MHz) may have occurred if one year has passed since shipment.

### ■ Amplitude accuracy

- Connection: Use coaxial cable to connect FUNCTION OUT to AC voltmeter 1.
- Setting: After setting initialize, set the amplitude, output range and waveform as indicated in the following table.
- Measurement: Measure the true rms output voltage for each waveform.
- Judgment: The normal ranges are indicated in the table.

Waveform	Output range	Setting	Normal range
	10 V	20 Vp-p/open (7.071 Vrms/open)	7.004 to 7.138 Vrms
	10 V	20 Vp-p/open ( 5.774 Vrms/open)	5.719 to 5.828 Vrms
	10 V	20 Vp-p/open ( 10.00 Vrms/open)	9.905 to 10.095 Vrms
	10 V	10 Vp-p/open ( 3.536 Vrms/open)	3.493 to 3.578 Vrms
	10 V	5 Vp-p/open (1.768 Vrms/open)	1.738 to 1.798 Vrms
	10 V	2 Vp-p/open (0.707 Vrms/open)	0.684 to 0.730 Vrms
	1 V	2 Vp-p/open (0.7071 Vrms/open)	0.699 to 0.716 Vrms





### ■ DC offset accuracy

- Connection: Connect FUNCTION OUT to a DC voltmeter.
- Setting: After setting initialize, set the DC mode, output range and DC offset as indicated in the following table.
- Measurement: Measure the output voltage.
- Judgment: The normal ranges are indicated in the table.

Output range	DC offset setting	Normal range
10 V	±10.000 V/open	±9.880 to ±10.12 V
10 V	±5.000 V/open	±4.905 to ±5.095 V
10 V	±2.000 V/open	±1.920 to ±2.080 V
10 V	±1.000 V/open	±0.925 to ±1.075 V
10 V	0.000 V/open	-0.070 to +0.070 V
1 V	±1.0000 V/open	±0.985 to ±1.015 V
1 V	0.0000 V/open	-0.010 to +0.010 V

### ■ Amplitude vs. frequency characteristics

- Connection: Use coaxial cable to connect FUNCTION OUT to AC voltmeter 2 (50  $\Omega$  termination).
- Setting: Initialize, then set the amplitude to 20 Vp-p/open and select the frequency and waveform as indicated in the table.
- Measurement: Measure the true rms output voltage for each frequency and waveform.
- Judgment: The normal ranges are indicated in the table.

Waveform	1 kHz Setting	to 500 kHz	to 1 MHz	to 3 MHz	to 10 MHz	to 15 MHz
	(Reference value)	+0.2/-0.3 dB	+0.2/-0.3 dB	+0.35/-0.7 dB	+0.5/-1.5 dB	+0.5/-2.0 dB
	(Reference value)	$\pm 0.3$ dB	—————	—————	—————	—————
	(Reference value)	$\pm 0.3$ dB	$\pm 0.3$ dB	—————	—————	—————
	(Reference value)	$\pm 0.5$ dB	—————	—————	—————	—————
	(Reference value)	$\pm 0.5$ dB	—————	—————	—————	—————

### ■ Sinewave distortion

- Connection: Use coaxial cable to connect FUNCTION OUT to a distortion meter (50  $\Omega$  termination).
- Setting: Initialize, then set the amplitude to 20 Vp-p/open and the frequency as indicated in the table.
- Measurement: Measure the distortion
- Judgment: The normal range is indicated in the table.

Frequency	Normal range
10 Hz to 100 kHz	0.2 % or less

(Bandwidth 500 kHz)

## ■ Squarewave response

- Connection: Use coaxial cable to connect FUNCTION OUT to an oscilloscope (50  $\Omega$  termination).
- Setting: Initialize, then set  $\square$ , frequency to 1 MHz and amplitude to 20 Vp-p/open.
- Measurement: Observe the waveform and measure the rise and fall times, overshoot and undershoot.
- Judgment: The normal range is indicated in the table.

Item	Normal range
Rise and fall times	20 ns or less
Overshoot and undershoot	5 % or less

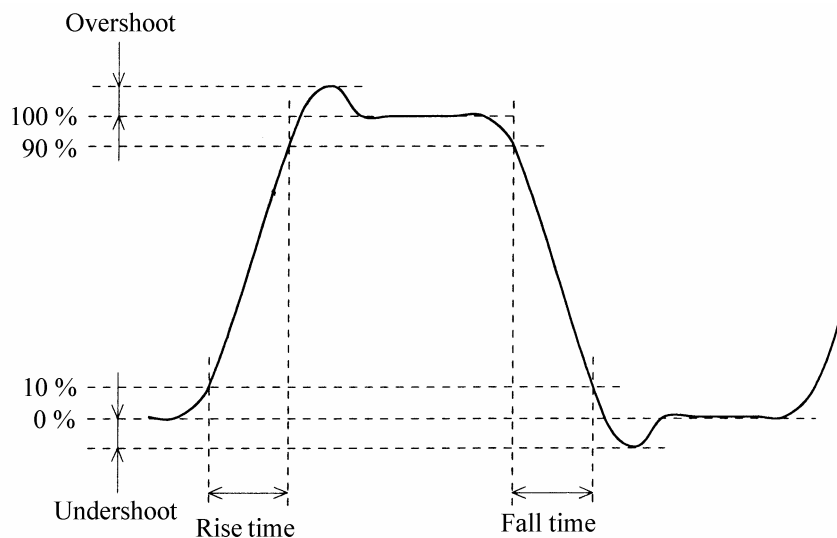

## ■ Duty factor

- Connection: Use coaxial cable to connect Function Out to a universal counter (50  $\Omega$  terminated).
- Settings: Initialize the settings, then set amplitude to 20 Vp-p, and waveform and frequency according to the following table.
- Measurement: Set the counter rise and fall period to the interval timer mode and measure the duty (time). Use the average value, since jitter will cause dispersion in the measurement values.
- Determination: The ranges indicated in the following table are normal.

Waveform	Frequency	Rated range
$\square$ (duty 50 % fixed)	1 MHz	490 to 510 ns
$\square$ (duty 50 % fixed)	10 MHz	47.0 to 53.0 ns
$\square$ (duty 50 % fixed)	15 MHz	30.0 to 36.7 ns
$\square$ (duty variable)	100 kHz	4.90 to 5.10 $\mu$ s

## Section 8 Specifications

8.1	Waveform and output characteristics .....	8-2
8.2	Output voltage .....	8-4
8.3	Other functions .....	8-5
8.4	Initialized settings .....	8-10
8.5	Remote control .....	8-11
8.6	Options .....	8-12
8.7	General items .....	8-13
	■ External drawing .....	8-14

Guaranteed values are shown with tolerance, values without tolerance are for reference.

## 8.1 Waveform and output characteristics









### ● Waveforms (FUNCTION OUT)

Output waveforms	,  ,  (Duty 50 % fixed),  (Duty variable), ,  , arbitrary waveform (ARB), and noise (NOISE), DC voltage (DC)
Waveform vertical resolution	16 bit ( ,  ,  ,  , arbitrary waveform (ARB))
Output waveform and frequency	
For continuous oscillation	,  (duty 50% fixed) : 0.01 $\mu$ Hz to 15 MHz ,  (duty variable),  ,  : 0.01 $\mu$ Hz to 500 kHz Arbitrary waveform : 0.01 $\mu$ Hz to 500 kHz However, the frequency in which all the data of arbitrary waveforms can be outputted is the maximum of the following value. $(40\text{MHz}) \div [\text{waveform data size (words)}]$ Analog band width 10MHz
For burst, trigger, gate, triggered gate, or gated sweep	0.01 $\mu$ Hz to 500 kHz
Frequency	
Range	0.01 $\mu$ Hz to 15 MHz
Resolution	0.01 $\mu$ Hz
Accuracy when shipped	$\pm 5$ ppm
Aging	$\pm 3$ ppm/year
Setting by period	Frequency equivalent to inverse number of the setting period. If the number is less than 0.01 $\mu$ Hz, the number should be rounded off.
Duty	
Range	0.0100% to 99.9900%/0.0000% to 100.0000%
Resolution	0.0001 %
Arbitrary waveform data size	Can be switched among 8 K, 16 K, 32 K, and 64 K words. 1 K words equal 1024 words.
Number of arbitrary waveforms	Number of arbitrary waveforms that can be select, and waveforms are backed up 12 waveforms for 8 K words/6 waveforms for 16 K words/ 3 waveforms for 32 K words/1 waveforms for 64 K words
Arbitrary waveform data origination	Point specification and linear interpolation by the panel operation or data writing by GPIB or USB
Arbitrary waveform data resolution	16 bits (-32768 to 0 to +32767) The 1992A digital output option outputs all 15 bits and clock.



Noise	<p>Noise source: pseudo-M-series by 42-step shift register          Period 30.518 hours, Spectrum interval          9.1022 <math>\mu</math>Hz</p> <p>White noise bandwidth (equivalent noise bandwidth): about          500 kHz</p> <p>Peak factor (crest factor): 6          Amplitude can be set in Vp-p.  <math>\text{rms value} = (\text{Vp-p set point}) \div 2 \div (\text{peak factor})</math></p> <p>Binary output: Outputs from SYNC OUT during NOISE mode.</p>
-------	--

## ● Output characteristics (FUNCTION OUT)

Amplitude frequency characteristics	<p>Continuous oscillation, 50 <math>\Omega</math> load, DC offset 0 V, amplitude setting 10 Vp-p/50 <math>\Omega</math>, normalized frequency 1 kHz, effective rms value measurement</p> <p> Up to 1 MHz: +0.2 dB, -0.3 dB          1 MHz to 3 MHz: +0.35 dB, -0.7 dB          3 MHz to 10 MHz: +0.5 dB, -1.5 dB          10 MHz to 15 MHz: +0.5 dB, -2.0 dB</p> <p> Up to 1 MHz: <math>\pm 0.3</math> dB</p> <p> Up to 500 kHz: <math>\pm 0.3</math> dB</p> <p> Up to 500 kHz: <math>\pm 0.5</math> dB</p>
 spectrum purity	<p>Continuous oscillation, external AM off, 50 <math>\Omega</math> load, DC offset 0 V, amplitude setting 10 Vp-p/50 <math>\Omega</math></p>
Total harmonic distortion	10 Hz – 100 kHz: 0.2 % and below (bandwidth: 500 kHz)
Harmonic spectrum	100 kHz to 1 MHz: -50 dBc and below 1 MHz to 15 MHz: -30 dBc and below
Spurious output	Up to 15 MHz: -35 dBc and below
 waveform characteristics	<p>Continuous oscillation, external AM off, 50 <math>\Omega</math> load, DC offset 0 V, amplitude setting 10 Vp-p/50 <math>\Omega</math></p> <p>Rise and fall time: 20 ns and below</p> <p>Overshoot: 5 % and below</p>
Duty	<p>Continuous oscillation, external AM off, 50 <math>\Omega</math> load, DC offset 0 V, amplitude setting 10 Vp-p/50 <math>\Omega</math></p> <p> (50 % fixed duty)          Up to 1 MHz: <math>\pm 1</math> % of the period          1 MHz to 10 MHz: <math>\pm 3</math> % of the period          10 MHz to 15 MHz: <math>\pm 5</math> % of the period</p> <p> (duty variable)          Up to 100 kHz: <math>\pm 1</math> % of the period          Jitter: 30 nsp-p and below</p>

## 8.2 Output voltage

### ● Output voltage (FUNCTION OUT)

Output range	10 V range / 1V range fixed, or automatic switchable
Amplitude	
Range	10 V range : 0 mVp-p to 20.000 Vp-p/open 1 V range : 0.0 mVp-p to 2.0000 Vp-p/open
Resolution	10 V range : 1 mVp-p/open 1V range : 0.1 mVp-p/open
Accuracy	Continuous oscillation, external AM off, $\sim$ , 1 kHz, rms value measured 10 V range : $\pm$ [0.7 % of amplitude setting (Vp-p) + 0.05 Vp-p]/open 1 V range : $\pm$ [0.7% of amplitude setting (Vp-p) + 0.01 Vp-p]/open
DC offset	
Range	10 V range : $\pm$ 10.000 V/open 1 V range : $\pm$ 1.0000 V/open
Resolution	10 V range : 1 mV/open 1 V range : 0.1 mV/open
Accuracy	DC mode, External AM off, external addition off 10 V range : $\pm$ (0.5% of DC offset setting [V] + 0.07 V)/open 1 V range : $\pm$ (0.5% of DC offset setting [V] + 0.01 V)/open
Amplitude and DC offset limiting	If output voltage exceeds the following value, the OVER light blinks and the output may be clipped. 10 V range : 11 V/open 1 V range : 1.1 V/open
Output impedance	50 $\Omega$ , unbalanced
Load impedance	45 $\Omega$ and more, nominal
Output connector	Front panel, BNC receptacle (FUNCTION OUT)
Others	Output voltage can be set with high and low level buttons.

### ● SYNC OUT Output voltage (SYNC OUT)

Output voltage	0/+5V (open)
Output waveform	$\square$
Rise/fall time	2.5 ns
Output impedance	50 $\Omega$ , unbalanced
Load impedance	45 $\Omega$ and more
Output connector	Front panel BNC receptacle (SYNC OUT)

## 8.3 Other functions

### ● Burst

Oscillation modes	Burst, gate, trigger and trig'd gate (Trig'd gate: gate on/off at each trigger)
Mark wave number	0.5 to 500000.0, 0.5 wave unit (The mark wave number is the oscillation wave number at the time of burst and trigger).
Space wave number	0.5 to 500000.0, 0.5 wave unit (Space wave number is the stop wave number at the time of burst).
Phase	Phase from oscillation stop to oscillation start
Range	-1800.000° to +1800.000°
Resolution	0.001°
Trigger source	Selectable internal trigger oscillator or external trigger input. Trigger can be applied from the panel keys or via remote control (GPIB or USB).
External trigger	
Polarity	Trigger: Rising or falling edge selectable Gate: Positive or negative logic selectable. Trig'd gate: Rising or falling edge selectable
Input level	High level $\geq +3.9$ V, low level $\leq +1.6$ V
Minimum pulse width	50 ns
Input impedance	At 10 k $\Omega$ , pull up to +5 V.
Input connector	Front panel BNC receptacle (TRIG/SWEEP IN)
Internal trigger oscillator	
Range	1 $\mu$ s to 100.0 s
Resolution	4 digits at 1 ms and more, 1 $\mu$ s at less than 1 ms.
Trigger delay	
Range	0.3 $\mu$ s to 100.00 s
Resolution	5 digits at 1 ms and more, 0.1 $\mu$ s at less than 1 ms. Oscillation mode: Effective with trigger.
Trigger jitter	Less than 50 ns
Oscillation stop level	On and off settable Off: stops at set phase. On: stops at set stop level.
Range	-100.0 % (maximum negative output) to +100.0 % (maximum positive output),
Resolution	0.01 %

## ● Sweep

Sweep items	Frequency, phase, amplitude, DC offset, and duty ( $\square$ duty variable)
Setting items	Sweep start/stop or sweep center/span Sweep marker, substitute sweep center for sweep marker Sweep start and stop state
Sweep functions	Continuous / single / gated sweep LIN/LOG (LOG is available frequency only) $\wedge$ / $\nearrow$ / $\square$ / $\sim$
Sweeping time	
Range	1 ms to 10000.000 s 2 ms to 10000.00 s (other times)
Resolution	1 ms
Sweep trigger	Indicates start of single / gated sweep.
Sweep trigger period	100 ms and more (If applying less than 100 ms, trigger is at 100 ms intervals).
Trigger source	Selectable internal trigger oscillator or external trigger input. Also, applicable from panel keys and via remote control (GPIB or USB)
External trigger	
Polarity	Selectable rise/fall.
Input connector	Front panel, BNC receptacle (TRIG/SWEEP IN)
Minimum pulse width	200 ns
Trigger delay	2 ms
Internal trigger oscillator period	
Range	1 $\mu$ s to 100.0 s
Resolution	4 digits at 1 ms and more, 1 $\mu$ s at less than 1 ms.
Oscillation stop level	On/off setting effective during gated sweep. (However, ineffective and fixed at off if the sweep item is duty) Off: stop at set phase. On: stop at set stop level.
Range	-100.00 % (maximum negative output) to +100.00 % (maximum positive output)
Resolution	0.01 %

## ● Sweep input/output

### Sweep trigger input

Input level	High level $\geq +3.9$ V, low level $\leq +1.6$ V
Signal characteristic	Single/gated sweep start at rising or falling edge (selectable)
Minimum pulse width	200 ns.
Input impedance	At 10 k $\Omega$ , pulling up to +5 V
Input connector	Front panel, BNC receptacle (TRIG/SWEEP IN) Combined use with trigger input for gate, trigger and trig'd gate

### Synchronous sweep output

Output level	0/+5 V (open)
Signal characteristics	Low level: sweeping from start to stop High level: Other times (If $\nearrow$ sweep, high level for about 0.2 ms to 0.5 ms directly before quick change from stop to start.)
Output impedance	50 $\Omega$ , unbalanced
Load impedance	45 $\Omega$ and more
Output connector	Front panel, BNC receptacle (SYNC OUT) Combined use with SYNC OUT

### Sweep stop/restart input

Input level	High level $\geq +3.9$ V, low level $\leq +1.6$ V
Signal characteristic	Low level: sweep interrupt High level: stop release
Input impedance	At 10 k $\Omega$ , pull up to +5 V.
Input connector	Rear panel, BNC receptacle (SWEEP PAUSE IN)

### Sweep marker output

Output level	0/+5 V/open
Signal characteristic	Low level: exceeds marker during sweep. High level: other times
Output impedance	30 $\Omega$ , unbalanced
Load impedance	1 k $\Omega$ and more
Output connector	Rear panel, BNC receptacle (SWEEP Z-MARKER OUT)

### Sweep X-DRIVE output

Output level	0 V to +5 V/open
Signal characteristics	0 V $\rightarrow$ +5 V: sweep value is increasing, +5 V $\rightarrow$ +0 V: sweep value is decreasing.
Output impedance	1 k $\Omega$ , unbalanced
Load impedance	10 k $\Omega$ and more
Output connector	Rear panel, BNC receptacle (SWEEP X-DRIVE OUT)

### ● Internal modulation functions

Modulation items	FM(FSK), PM(PSK), AM, DC offset modulation, PWM (□ duty variable)
Internal modulation frequency	
Range	0.1 mHz to 500.00 Hz
Resolution	5 digits at 1 Hz and more, 0.1 mHz at less than 1 Hz.
Internal modulation waveform	~ , ^ , □ , / , \

### ● External modulation functions

Modulation item	AM, on/off selectable
External modulation frequency	DC to 10 MHz
External AM depth	-3 V input: -100% -1 V input: 0% 0 V input: 50 % of the set amplitude +1 V input: the set amplitude.
Input voltage range	-3 V to +1 V
Input impedance	50 Ω
Input connector	Rear panel BNC receptacle (EXT AM IN)

### ● External add functions

External add	Add external signal to FUNCTION OUT signal On/off selectable
External addition frequency	DC to 10 MHz
External addition gain	At no-load 10 V range: × 2 1 V range: × 0.2
Input voltage range	±5 V
Input impedance	50 Ω
Input connector	Rear panel BNC receptacle (EXT ADD IN)

### ● Setting initialization

Functions	Initializes nearly all setting contents. Initialization settings,  "3.3 Basic operation (Initialization table)", cf.
-----------	---

## ● User-unit function

Function	Converts to desired units for set up and display.
Setting items	Frequency, period, amplitude, DC offset, phase and duty.
Coefficient setting	Select either [(internal set up) + n] × m, or [log <sub>10</sub> (internal set up) + n] × m; then, set the value of n and m. Frequency and period: 15 digits mantissa and 1 digit index (both m and n) Amplitude, DC offset, and duty.: 6 digits mantissa and 1 digit index (m and n) Phase : 7 digits mantissa and 1 digit index
Unit character string	Alphanumeric and 34 symbols Set up and display up to 4 characters.

## ● Load function

Function	Set up and display at actual voltage for an arbitrary load Conversion formula: (Output voltage at load) = (Output voltage at no-load) × $\frac{(\text{Load impedance})}{(\text{Output impedance} : 50 \Omega) + (\text{Load impedance})}$
Load impedance	
Range	45 Ω to 999 Ω
Resolution	1 Ω

## ● Output on/off

Function	Output switched on/off
Output off state	FUNCTION OUT: open. SYNC OUT: TTL three states high impedance.
Power on state	Selectable return to the state when the power supply was switched off or output on/off state.

## ● Setting memory, Backup

Setting memory	Nearly all setting items can be stored and recalled. 10 sets from 0 to 9
Backup	Battery back up for nearly all settings prior to power off.
Backup period	Three years and more under normal temperature.
Battery	Lithium cell
Operation when battery depleted	Error at power on and settings are initialized. Setting memory and arbitrary waveform memory are initialized. Battery needs replacement (fee charged)

## 8.4 Initialized settings

- **Initialized settings**

Initialization,  “3.3 Basic operation (Initialization table)”, cf.

- **Error from backup battery depletion**

In addition to setting initialization, following are set:

Output on/off	Off
Output on/off in turning on	LAST-STATE (condition just before power off)
Setting memory	ALL NOT STORED
Setting memory comment	" " (blank)
User unit name	USER
User unit computation formula	$(h+n)*m$
User unit coefficient	1
User unit offset	0
Arbitrary waveform selection	ARB_00
Arbitrary waveform name	ARB_00 ~ ARB_11
Arbitrary waveform data size	8K
Arbitrary waveform data	All 0
Remote control interface	GPIB
GPIB address	2
GPIB delimiter	CR+LF
USB ID	2



## 8.5 Remote control

### ● GPIB interface

GPIB function	SH1 All source handshake functions AH1 All acceptor handshake functions T6 Basic talker, serial poll, talker release by MLA L4 Basic listener, listener release by MTA SR1 All service request functions RL1 All remote/local functions PP0 No parallel poll functions DC1 All device clear functions DT1 All device trigger functions C0 No controller functions
Use code	ISO 7 bit codes (ASCII code)
Address	0 to 30 (set from panel)
Output driver	DIO1-8, NDAC, NRFD and SRQ : Open collector DAV and EOI : three state
GPIB parameters	GPIB address (0 to 30), delimiter in transmission (CR/LF+EOI, CR+EOI, LF+EOI)
Remote release	Remote condition can be canceled by LOCAL key. (Except for Local Lockout)
Connector	Rear panel, IEEE 488 (24-pins) connector

### ● USB interface

USB1.1 full speed

## 8.6 Options

- **1991 synchronous operation option**

Function	Synchronous operation of multiple units of the WF 19 series* 1991 is required all synchronous operation.
Time difference	Under condition of continuous oscillations, external AM off, 50 Ω load, DC offset 0 V and amplitude setting 10 V <sub>p-p</sub> /50 Ω, phase synchronization after setting same waveform and frequency, The time difference among the equipment: (±25 ns + 10 ns/unit) and below. The cable connecting multiple units of the WF 19 series* is optional.
Others	(1994 synchronous operation cable)

- **1994 synchronous operation cable**

1991 synchronous operation option, for connecting multiple units of the WF 19 series\*. To connect n units of the WF 19 series\* (n-1) of 1994 synchronous operation cables are necessary.

- **1992A digital output option**

Function	Output digital signal applied to waveform D/A. Upper 15 bits of the 16-bit waveform data and the clock are output.
Data format	The relation between arbitrary waveform data setting and output data is as follows :

Arbitrary waveform data		Output data
ARB and: Data: DAC commands	ARW and: Data: DAC WORD commands	
+16383	+32766、 +32767	7FFFH
+16382	+32764、 +32765	7FFE H
+16381	+32762、 +32765	7FFD H
⋮	⋮	⋮
+2	+4、 +5	4002H
+1	+2、 +3	4001H
0	0、 +1	4000H
-1	-2、 -1	3FFFH
-2	-4、 -3	3FFE H
⋮	⋮	⋮
-16382	-32764、 -32763	0002H
-16383	-32766、 -32765	0001H
-16384	-32768、 -32767	0000H

Accessory                      Digital output cable: One

\*1: The following products: 1945, 1946, 1956, WF1945, WF1946, WF1956, WF1945A, WF1946A, WF1965, WF1966, WF1945B, and WF1946B

## 8.7 General items

- **Input/output ground**

The signal ground of FUNCTION OUT, SYNC OUT, EXT AM IN, EXT ADD IN, and DIGITAL OUT is floated from the chassis and the input/output ground of these signals is common.

Signal ground dielectric strength: 42 V<sub>peak</sub>, 30 V<sub>rms</sub> (DC to 20 kHz continuous)

The input/output ground of all other signals is connected to the chassis.

- **Power supply**

Power supply voltage range AC100 V/115 V/230 V

Power supply frequency range 50/60 Hz ± 2 Hz

Power supply fuse Time lag 1 A (100 V/115 V) or time lag 0.5 A (230 V)  
250 V, Φ5.2 × 20 mm

Consumption electric power 65 VA and less

Overvoltage category II

- **Cooling**

Forced-air cooling, rear exhaust

- **Setup condition**

Horizontal (Within 10°)

- **Environmental conditions**

Ambient temperature and humidity range

Performance guarantee +5 to +35° C, 5 to 85 %RH

(no condensation at an absolute humidity of 1 to 25 g/m<sup>3</sup>)

Storage time -10 to +50° C, 5 to 95 %RH

(no condensation at an absolute humidity of 1 to 29 g/m<sup>3</sup>)

Pollution degree 2

- **Insulation resistance**

20 MΩ and more (DC 500 V, power input lines versus chassis).

- **Withstand voltage**

AC 1500 V (power input lines versus chassis).

- **Dimensions**

216(W) × 132.5(H) × 290(D) mm (Excluding protrusions).

- **Mass**

Mainframe excluding attachments, options, etc.

Approx. 4.3 kg

- **Safety**

EN 61010-1: 2001

- **EMC**

EN 61326: 1997/A1: 1998/A2: 2001

However, the performance criteria for the following standards are as follows:

EN61000-4-2(1995), EN61000-4-4(1995), EN61000-4-5(1995), and EN61000-4-11(1994):B

External drawing

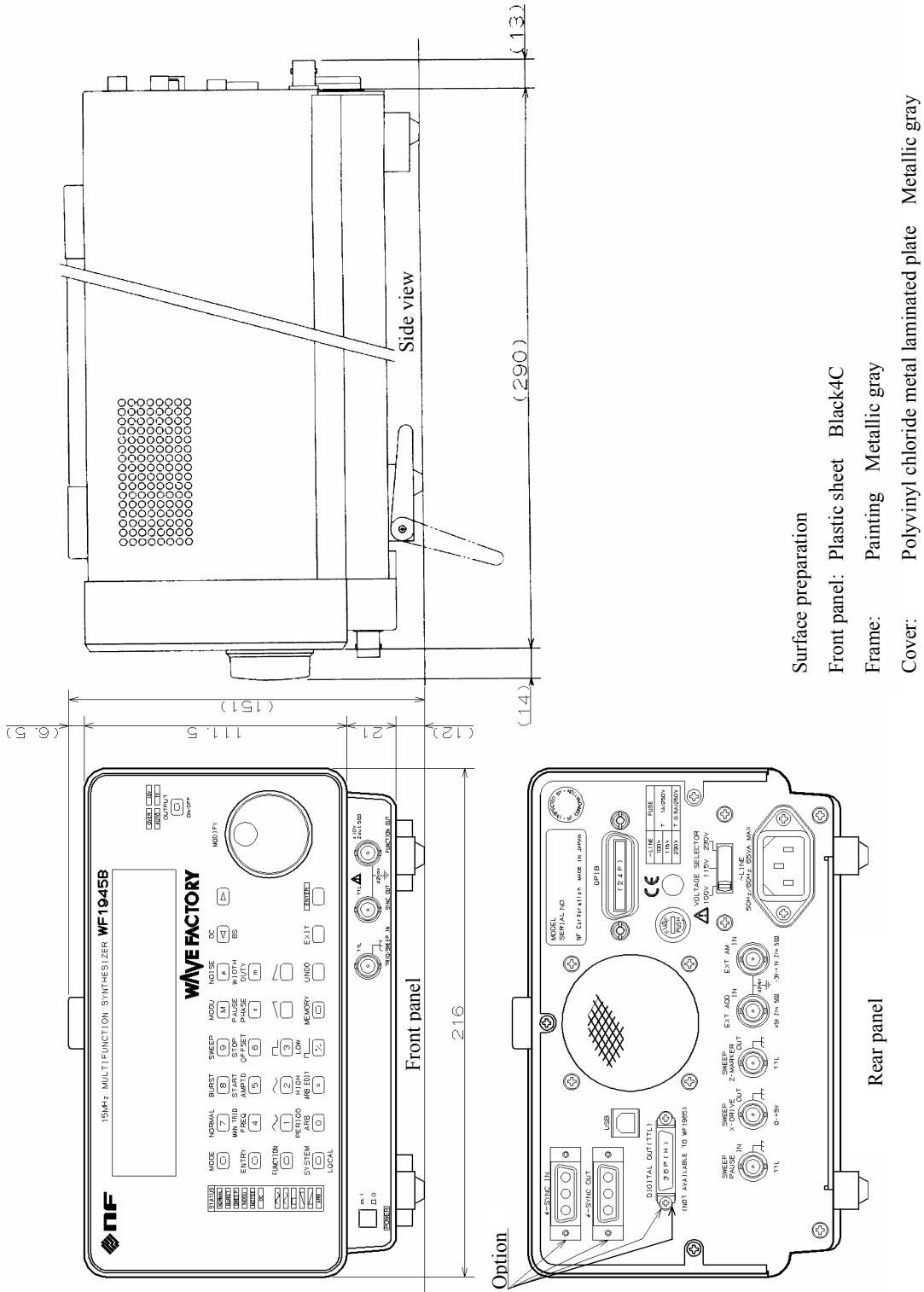

# Index

Front and rear panel indications (alphabetical order).

- AMPTD.....3-24, 5-6, 5-8, 5-20  
ARB.....4-55, 5-8  
ARB EDIT.....4-56  
BS.....3-23, 3-24, 3-25, 3-26  
BURST.....3-8, 3-19, 4-2  
DC.....3-8, 3-19, 3-22, 3-23, 3-24, 3-25  
DIGITAL OUT.....3-14  
DUTY.....5-3, 5-4  
ENTER.....3-3, 3-16, 5-7  
ENTRY.....3-23, 3-24, 3-25, 3-26,  
5-2, 5-3, 5-4, 5-5  
EXIT.....3-3, 3-16  
EXT ADD IN.....3-11, 5-16  
EXT AM IN.....3-12, 5-17  
FREQ.....3-23, 5-3, 5-4  
FUNCTION.....3-20, 4-55  
FUNCTION OUT.....3-5  
HIGH.....5-5  
k.....4-58, 5-7  
LOCAL...REMOTE CONTROL separate volume  
LOW.....5-5  
m.....4-57, 5-7  
M.....5-7  
MAN TRIG.....4-8, 4-12, 4-15, 5-23  
MEMORY.....5-13  
MODE.....3-19, 4-2, 4-16, 4-40  
MODU.....3-8, 3-19, 4-40  
NOISE.....3-8, 3-19, 3-22, 3-23, 5-8  
NORMAL.....3-19, 5-24  
OFFSET.....3-25, 5-6, 5-20  
OUTPUT.....3-3, 3-27  
OVER.....3-5  
PAUSE.....4-20, 4-25, 4-32  
PERIOD.....5-2, 5-3, 5-4  
PHASE.....3-26, 5-24  
START.....4-19, 4-25, 4-31, 4-42,  
4-45, 4-48, 4-51, 4-54  
STOP.....4-19, 4-20, 4-21, 4-25, 4-26,  
4-32, 4-42, 4-45, 4-48, 4-51, 4-54  
SWEEP.....3-8, 3-19, 4-16  
SWEEP PAUSE IN.....3-10, 4-20, 4-25, 4-32  
SWEEP X-DRIVE OUT.....3-10, 4-38  
SWEEP Z-MARKER OUT.....3-11, 4-34, 4-38  
SYNC OUT.....3-6, 4-38  
SYSTEM.....3-16, 5-9, 5-16, 5-17,  
5-18, 5-19, 5-20, 5-24  
TRIG/SWEEP IN.....3-9, 4-8, 4-11, 4-14,  
4-20, 4-32, 5-23  
UNDO.....5-21  
WIDTH.....5-3, 5-4  
 $\phi$ -SYNC IN,OUT.....3-12, 5-24  
 $\mu$ .....5-7



## WARRANTY

**NF Corporation** certifies that this instrument was thoroughly tested and inspected and found to meet its published specifications when it was shipped from our factory.

All **NF** products are warranted against defects in materials and workmanship for a period of one year from the date of shipment. During the warranty period of, **NF** will, at its option, either will repair the defective product without any charge for the parts and labor, or either repair or replace products which prove to be defective. For repair service under warranty, the product must be returned to a service center designated by **NF**. Purchaser shall prepay all shipping cost, duties, and taxes for the product to **NF** from another country, and **NF** shall pay shipping charge to returned the product to purchaser.

This warranty shall not apply to any defect, failure or damage caused by improper use, improper or inadequate maintenance and care or modified by purchaser or personnel other than **NF** representatives.

**NF Corporation**





WABUN: (≈DA00012269-002)

If there are any misplaced or missing pages, we will replace the manual. Contact the sales representative.

#### NOTES

- Reproduction of the contents of this manual is forbidden by applicable laws.
- The contents of this manual may be revised without notice.
- Information provided in this manual is intended to be accurate and reliable. However, we assume no responsibility for any damage regarding the contents of this manual.
- We assume no responsibility for influences resulting from the operations in this manual.

Copyright 2005, **NF Corporation**

WF1945B MULTIFUNCTION SYNTHESIZER Instruction Manual

#### **NF Corporation**

3-20 Tsunashima Higashi 6-chome, Kohoku-ku. Yokohama-shi  
223-8508, JAPAN

Phone +81-45-545-8111 Fax +81-45-545-8191





