



LCR METER

# ZM2371 / ZM2372

---

Instruction Manual



DA00026021-001

**LCR METER**

# **ZM2371 / ZM2372**

**Instruction Manual**

### **Registered Trademarks**

National Instruments and LabVIEW are registered trademarks of National Instruments Corporation in the United States.

Other company names and product names used in this Instruction Manual may be trademarks or registered trademarks of respective companies.

## Preface

Thank you very much for purchasing our “**ZM2371/ZM2372 LCR METER**”. To ensure safe and proper use of this electric equipment, please read first “**Safety Precautions**” on the following pages.

### ■ Caution Symbols Used in This Manual

The following caution symbols are used in this manual. Be sure to observe these caution symbols and their contents to ensure the safety of the user and avoid damage to the equipment.

---

** WARNING**

---

This symbol indicates information for the avoidance of a hazard such as electric shock that may endanger human life or cause injury during handling of the equipment.

---

---

** CAUTION**

---

This symbol indicates information for the avoidance of damage to the equipment during handling.

---

● **This manual has the following chapter organization.**

If using this equipment for the first time, start from Chapter 1.

**1. OUTLINE**

This chapter describes the overview, specificities, applications, functions and simple principle of operations of this product.

**2. PREPARATIONS BEFORE USE**

This chapter describes important preparation before installation and operation.

**3. PANEL FEATURES AND BASIC OPERATIONS**

This chapter describes the functions and simple operations available for each panel screen part.

Read while operation the device.

**4. ADVANCED OPERATIONS**

This chapter describes even further the device operation.

**5. REMOTE CONTROL**

This chapter describes remote control through USB, RS-232 and GPIB.

**6. CHANGE OF OPERATION MODE**

This chapter describes how to use remote control commands and operation panel different from a standard method.

**7. TROUBLESHOOTING**

This chapter describes how to deal with error messages and troubles.

**8. MAINTENANCE**

This chapter describes storage, repacking transportation as well as performance testing.

**9. SPECIFICATIONS**

This chapter describes the product's specifications (functions and performance).

## — Safety Precautions —

To ensure safe use, be sure to observe the following warnings and cautions.

NF Corporation shall not be held liable for damages that arise from a failure to observe these warnings and cautions.

This product is a Class I product (with protective conductor terminal) that conforms to the JIS and IEC insulation standards.

- **Be sure to observe the contents of instruction manual.**

This instruction manual contains information for the safe operation and use of this product.

Be sure to read this information first before using this product.

All the warnings in the instruction manual must be heeded to prevent hazards that may cause major accidents.

- **Be sure to ground the product.**

To prevent electric shock, be sure to implement grounding in accordance with the Type D grounding (100Ω or less) specified in the “Electrical Equipment Technical Standard,” or better.

This product is automatically grounded when its three-pole power supply plug is connected to a three-pole power outlet with a protective-ground contact.

When using a three-pole to two-pole conversion adapter, be sure to connect the grounding wire (green color) of the adapter to the grounding terminal next to the outlet.

- **Check the power supply voltage**

This product operates on the power supply voltage indicated in “**Grounding and Power Supply Connection**” in this instruction manual.

Prior to connecting the power supply, check that the voltage of the power supply matches the rated power supply of the product.

- **In case of suspected anomaly**

If this product emits smoke, an abnormal smell, or abnormal noise, immediately power it off and stop using it.

If such an abnormal occurs, prevent anyone from using this product until it has been repaired, and immediately report the problem to NF Corporation or one of our representatives.

- **Do not use this product when gas is present.**

An explosion or other such hazard may result.

- **Do not remove the cover.**

This product contains high-voltage parts. Absolutely never remove its cover.

Even when the inside of this product needs to be inspected, do not touch the inside. All such inspections are to be performed by service technicians designated by NF Corporation.

- **Do not modify this product.**

Absolutely never modify this product, as this may cause new hazards and may disqualify this product from repair in case of failure.

- **Safety-related symbols**

The general definitions of the safety-related symbols used on this product and in the instruction manual are provided below.

**Instruction Manual Reference Symbol**

This symbol is displayed to alert the user to potential danger and refer him/her to the instruction manual.

**Electric Shock Danger Symbol**

This symbol indicates locations that present a risk of electric shock under specific conditions.

**Warning Symbol**

This symbol indicates information for the avoidance of a hazard such as electric shock that may endanger human life or cause injury during handling of the equipment.

**Caution Symbol**

This symbol indicates information for the avoidance of damage to the equipment during handling.

- **Other Symbols**



This symbol indicates the “on” position of the power switch.



This symbol indicates the “off” position of the power switch.



Shows when connected to the case.



Shows when connected to the ground.

## ———— Electromagnetic Compatibility ————

This product conforms to the CISPR 11 Group 1 Class A. Using the product in general office or residence other than industrial area could give electromagnetic interference to other devices.

## ———— Note on Waste Processing ————

To protect the environment, ensure that this device is disposed of by an appropriate industrial waste processor. This product does not use batteries or a backlight that contains mercury.



---

## Contents

---

	Page
1. OUTLINE	1-1
1.1 Features	1-2
1.2 Applications	1-2
1.3 List of Functions	1-3
1.4 Principle of Operation	1-4
2. PREPARATIONS BEFORE USE	2-1
2.1 Checking Before Use	2-2
2.2 Installation	2-4
2.2.1 General Precautions for Installation	2-4
2.2.2 Installation Conditions	2-4
2.2.3 Rack Mounting	2-5
2.3 Grounding and Power Supply Connection	2-10
2.4 Simplified Operation Check	2-11
2.5 Calibration	2-12
3. PANEL FEATURES AND BASIC OPERATIONS	3-1
3.1 Panel Component Names and Functions	3-2
3.2 Display at Power "ON" and Initial Settings	3-4
3.2.1 Check before Power "ON"	3-4
3.2.2 Displays and Indications at Power "ON"	3-5
3.2.3 Initialization	3-6
3.3 Operation Tree	3-10
3.4 Connection of DUT	3-13
3.4.1 Measurement Terminals	3-13
3.4.2 Connection to DUT	3-14
3.4.3 Precautions on Connection	3-15
3.5 Basic Operations	3-17
3.5.1 Outline of Measurement Screen	3-17
3.5.2 Basic Key Operations	3-18
3.5.3 Simplified Operating Method When You Use Device for the First Time	3-21
3.5.4 Initialization	3-25
3.5.5 Setting of Measurement Parameters	3-26
3.5.5.1 Selection of Primary Parameters	3-26
3.5.5.2 Setting of Equivalent Circuit	3-28
3.5.5.3 Setting of Secondary Parameters	3-29
3.5.6 Setting of Basic Measurement Conditions	3-31
3.5.6.1 Measurement Frequency	3-31
3.5.6.2 Measurement Signal Level	3-32
3.5.6.3 Measurement Range	3-35
3.5.6.4 Trigger	3-38
3.5.6.5 Measurement Speed	3-42
3.5.6.6 Correction of Measurement Error	3-44
3.5.6.7 OPEN Correction	3-45
3.5.6.8 SHORT Correction	3-50
3.5.6.9 LOAD Correction	3-53
3.5.6.10 Cable Length Correction	3-57

4.	ADVANCED OPERATIONS .....	4-1
4.1	Restricting the Variation of Measured Values (Averaging) .....	4-2
4.2	Displaying the Deviation from the Reference Value .....	4-3
4.3	Sorting the Part (Comparator) .....	4-6
4.4	Connecting to the Part Handler (Handler Interface) .....	4-15
4.5	Changing the Contents Displayed on the Second line of Measurement Screen (Auxiliary Display) .....	4-22
4.6	Saving/Recalling the Setting and Correction Value into the Memory .....	4-24
4.7	Setting the Contact Check .....	4-26
4.8	Using the DC Bias .....	4-30
4.9	Disabling the Key-Operation of Panel .....	4-35
4.10	Initializing of All Settings .....	4-36
4.11	Self-Diagnosis .....	4-39
4.12	Checking the Version .....	4-40
5.	REMOTE CONTROL .....	5-1
5.1	Preparations Before Use .....	5-2
5.1.1	Remote Control Interface Selection .....	5-2
5.1.2	Outline of USB .....	5-3
5.1.2.1	Preparation of Controller .....	5-3
5.1.2.2	Preparation of ZM2371 / ZM2372 .....	5-4
5.1.2.3	USB Device Identification .....	5-4
5.1.3	Outline of RS-232 .....	5-5
5.1.3.1	Preparation of Controller .....	5-5
5.1.3.2	Preparation of ZM2371 / ZM2372 .....	5-5
5.1.3.3	Connection .....	5-8
5.1.3.4	Difference between RS-232 and USB/GPIB, and Precautions .....	5-9
5.1.4	Outline of GPIB .....	5-10
5.1.4.1	Preparation of Controller .....	5-10
5.1.4.2	Preparation of ZM2372 .....	5-10
5.1.4.3	Precautions on Use of GPIB .....	5-10
5.1.4.4	Basic Specifications of GPIB .....	5-11
5.1.5	Precautions on Communication .....	5-12
5.2	Switching between Remote State and Local State .....	5-13
5.3	Response to Interface Message .....	5-14
5.4	Command List .....	5-15
5.5	Command Tree .....	5-19
5.6	Command Explanation .....	5-21
5.6.1	Summary of Terms .....	5-21
5.6.1.1	Subsystem Commands .....	5-21
5.6.1.2	Path Separator .....	5-21
5.6.1.3	Keywords Simplification .....	5-22
5.6.1.4	Implicit Keywords .....	5-22
5.6.2	Overlap Commands and Sequential Commands .....	5-22
5.6.3	Command Detailed Explanations .....	5-23
5.6.3.1	Common Commands .....	5-24
5.6.3.2	Subsystem Commands .....	5-28

## Contents

---

5.7	Status System .....	5-75
5.7.1	Status System Overview .....	5-75
5.7.2	Status Byte .....	5-76
5.7.3	Standard Event Status .....	5-77
5.7.4	Operation Status .....	5-79
5.8	Trigger System .....	5-82
5.9	Sample Programs .....	5-84
6.	CHANGE OF OPERATION MODE .....	6-1
6.1	Outline and Switching of Operation Mode .....	6-2
7.	TROUBLESHOOTING .....	7-1
7.1	Error Messages .....	7-2
7.1.1	Errors at Power ON .....	7-2
7.1.2	Errors at Panel Operation .....	7-2
7.1.3	Errors During Measurement .....	7-4
7.1.4	Errors in Remote Control .....	7-5
7.1.5	Measured Value Display in Case of Error .....	7-7
7.2	When the Device Appears to be a Problem .....	7-8
8.	MAINTENANCE .....	8-1
8.1	Introduction .....	8-2
8.2	Daily Maintenance .....	8-2
8.3	Storage, Repacking, and Transportation .....	8-2
8.4	Checking Version Number .....	8-3
8.5	Checking Isolation .....	8-3
8.6	Checking the Contact Check Function .....	8-3
8.7	Performance Testing .....	8-4
8.7.1	Measurement Frequency Accuracy .....	8-4
8.7.2	Measurement Signal Level Accuracy .....	8-4
8.7.3	Voltage Monitor Accuracy .....	8-5
8.7.4	DC Bias Voltage Accuracy .....	8-6
8.7.5	AC Impedance Measurement Accuracy .....	8-7
8.7.6	DC Resistance Measurement Accuracy .....	8-11
8.8	Calibration .....	8-12
9.	SPECIFICATIONS .....	9-1
9.1	Specifications .....	9-2
9.2	External Dimensions .....	9-12

## Contents

---

### Attached figures and tables

---

	Page
Figure 1-1 Block Diagram .....	1-4
Figure 2-1 Rack-mount assembly (mm-rack) .....	2-6
Figure 2-2 Rack-mount assembly (inch-rack) .....	2-7
Figure 2-3 Size and dimensions of the rack-mount (mm-rack) .....	2-8
Figure 2-4 Size and dimensions of the rack-mount (inch-rack) .....	2-9
Figure 3-1 Front panel .....	3-2
Figure 3-2 Rear panel .....	3-3
Figure 3-3 Functions of measurement terminals .....	3-13
Figure 3-4 Connection to DUT .....	3-14
Figure 3-5 Measurement sequence .....	3-38
Figure 3-6 Signal acquisition time .....	3-43
Figure 3-7 Terminal processing at OPEN correction .....	3-46
Figure 3-8 Terminal processing at SHORT correction .....	3-51
Figure 3-9 Installation of standard for LOAD correction .....	3-55
Figure 4-1 Output of comparator result .....	4-7
Figure 4-2 Range setting and comparison when sorting into bins .....	4-11
Figure 4-3 Equivalent circuit of handler interface .....	4-17
Figure 4-4 Handler interface operation timing .....	4-18
Figure 4-5 Dummy output timing .....	4-21
Figure 4-6 4-terminal contact check .....	4-27
Figure 4-7 External voltage bias circuit .....	4-32
Figure 4-8 External current bias circuit .....	4-34
Figure 5-1 RS-232 cable connection diagram .....	5-8
Figure 5-2 Status system .....	5-75
Figure 5-3 Standard event status structure .....	5-77
Figure 5-4 Operation status structure .....	5-79
Figure 5-5 Trigger system .....	5-82
Figure 9-1 Range of error .....	9-7
Figure 9-2 LC - Z conversion graph .....	9-8
Figure 9-3 ZM2371 External dimensions .....	9-12
Figure 9-4 ZM2372 External dimensions .....	9-13

## Contents

---

Table 2-1	Package contents .....	2-2
Table 3-1	Setting items and initial values .....	3-7
Table 3-2	Measurement range list .....	3-35
Table 3-3	Max. current, max. voltage and output impedance in each measurement range .....	3-35
Table 3-4	Example of measurement time (typical values) .....	3-42
Table 4-1	Initialization contents of comparator .....	4-10
Table 4-2	Handler interface signal layout .....	4-15
Table 4-3	Functions of handler interface signal .....	4-16
Table 5-1	Responses to interface messages .....	5-14
Table 5-2	Common command list .....	5-15
Table 5-3	Subsystem command list .....	5-16
Table 5-4	Status byte register definitions .....	5-76
Table 5-5	Standard event status register contents .....	5-77
Table 5-6	Contents of operation condition register and event register .....	5-80
Table 7-1	When the device appears to be a problem .....	7-8



# 1. OUTLINE

1.1 Features.....	1-2
1.2 Applications.....	1-2
1.3 List of Functions.....	1-3
1.4 Principle of Operation.....	1-4

---

## 1.1 Features

The “**ZM2371 / ZM2372 LCR Meter**” is a high speed LCR meter with the maximum frequency 100kHz and maximum signal level 5V. It has high basic accuracy of 0.08% and is capable of measuring the impedance in a wide application range from manufacturing and inspection lines of electronic parts up to the research of materials.

- **Measurement frequency 1mHz to 100kHz**

The device has the maximum 5-digit resolution and thus it is capable of measuring the detailed frequency characteristics of the DUT (Device Under Test).

- **Signal level 10mV to 5V**

It is capable of measuring the characteristics of DUT in a wide signal level range.

- **Constant voltage / constant current drive**

It can make evaluation on stable signal level even for the DUT of which characteristics vary with the signal level.

- **High speed measurement**

It provides high speed measurement at the fastest 2ms (1kHz) or 10ms (120Hz).

- **Cable length 0m / 1m / 2m / 4m**

Allowable length of connection cable to the DUT is maximum 4m (frequency  $\leq$  1kHz).

- **4-terminal contact check (standard for ZM2372. Not provided for ZM2371)**

It can detect a contact failure of all measurement terminals to prevent a measurement error.

- **Triggered drive**

A signal is output after the device contacted the DUT, thus reducing the contact damage when high capacitance capacitor is measured. Also, this feature reduces measurement dispersion of the DUT having hysteresis characteristics.

- **Handler interface (standard for ZM2372. Not provided for ZM2371)**

The bin sorting results of maximum 14 categories can be output to the part handler.

- **Remote control**

The USB and RS-232 (230.4kbps max.) interfaces are furnished as standard. Also, the **ZM2372** is furnished with GPIB interface as standard (not provided for **ZM2371**).

- **DC (Direct-current) resistance measurement**

Direct-current resistance such as a winding resistance of inductor or transformer can be measured.

- **Settings and correction value memory**

32 sets of settings and correction values can be stored in nonvolatile memory, and they can be used selectively.

## 1.2 Applications

Inspection, sorting, and evaluation test in production lines of capacitors, inductors, and sensors. Evaluation and research of dielectrics and magnetic materials.



## 1.3 List of Functions

The following shows the outline of functional tree of **ZM2371 / ZM2372**.



## 1.4 Principle of Operation

The **ZM2371 / ZM2372** gives sine-wave signal from an internal oscillator to the DUT (Device Under Test). The impedance bridge detects the current  $I$  flowing in DUT and the voltage  $V$  applied to DUT, and then the main processor obtains the impedance  $Z (= V / I)$ . The parameters such as inductance  $L$ , capacitance  $C$ , resistance  $R$ , etc. are calculated from the impedance (magnitude, phase angle).

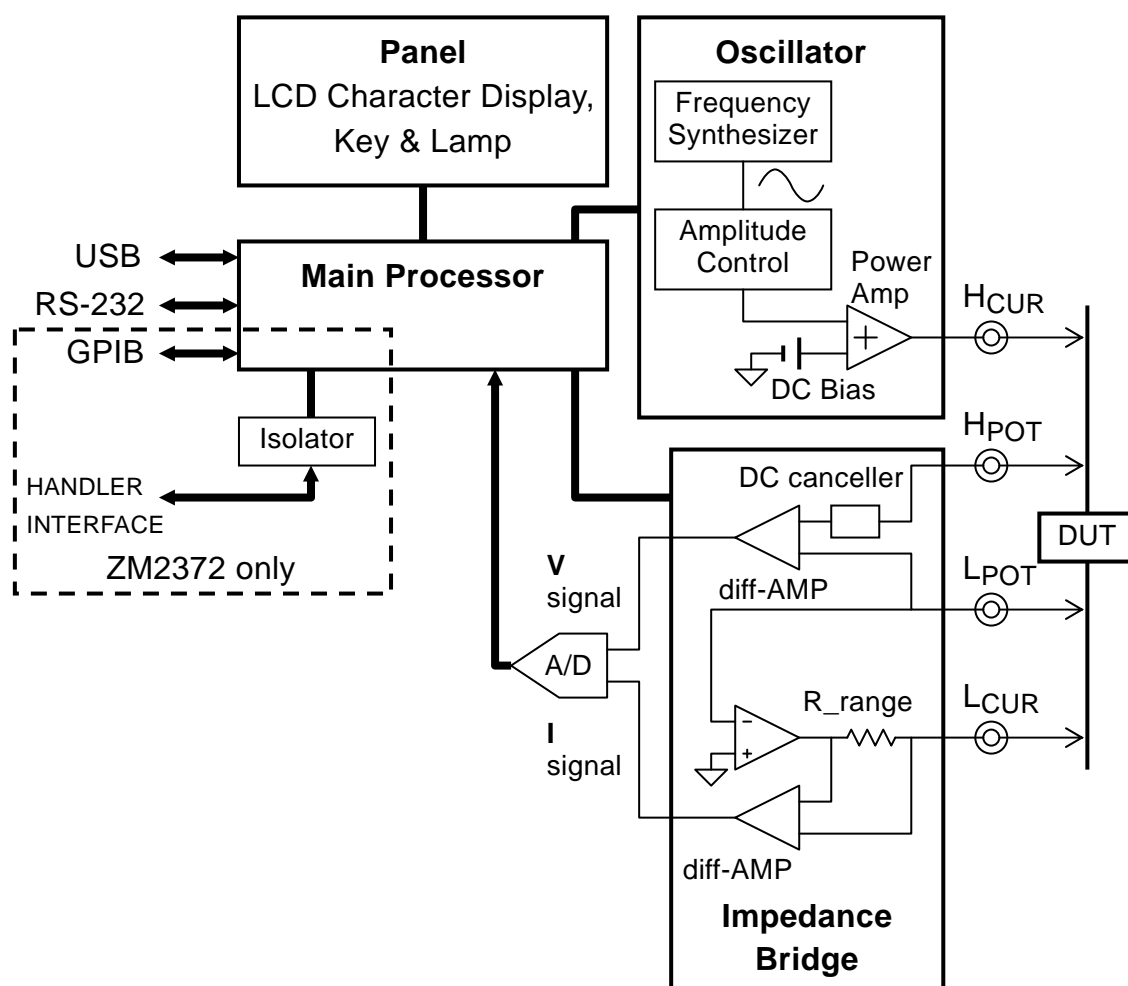

Figure 1-1 Block Diagram

- **Main Processor**

According to the user's operation, the main processor controls the oscillator and impedance bridge to calculate the vector ratio from the voltage signal and current signal obtained from the DUT. Then, the main processor makes necessary correction, and finally converts the data into the required parameter to be displayed or output.

- **Oscillator**

The oscillator generates sine-wave signals having exact frequencies by means of a direct digital frequency synthetic method based on the reference clock of crystal oscillator.

When the Automatic Level Control (ALC) function is effective, the main processor adjusts automatically the signal level so that the voltage and current monitored values become the specified values.

- **Impedance Bridge**

The current flowing in the DUT is converted into the voltage by the range resistance and differential amplifier. At this time, the potential between  $L_{CUR}$  and  $L_{POT}$  terminals is maintained to almost zero by automatic balancing motion of the bridge. Accordingly, the current that runs away to the ground through capacitance to earth and insulation resistance and is not detected can be reduced.

The voltage applied to the DUT is detected by the differential amplifier.

After that, the voltage signal and current signal are converted into digital values by the A/D converter, and sent to the main processor.



## 2. PREPARATIONS BEFORE USE

2.1	Checking Before Use .....	2-2
2.2	Installation.....	2-4
2.2.1	General Precautions for Installation .....	2-4
2.2.2	Installation Conditions .....	2-4
2.2.3	Rack Mounting .....	2-5
2.3	Grounding and Power Supply Connection.....	2-10
2.4	Simplified Operation Check.....	2-11
2.5	Calibration.....	2-12

## 2.1 Checking Before Use

### ■ Safety check

Before using **ZM2371 / ZM2372**, make sure you read “**Safety Precautions**”, Located at the beginning of this instruction manual and observe the required cautions.

Before turning the power on, read “**2.3 Grounding and Power Supply Connection**” and observe the necessary cautions.

### ■ Unpacking

Check that the device has not been damaged during transit.

After unpacking, make sure that the contents listed in “**Table 2-1 Package Contents**” are supplied.

**Table 2-1 Package contents**

<b>ZM2371 or ZM2372</b> Body .....	1
Instruction Manual .....	1
CD-ROM (Application Software, etc.) .....	1
Power Cord Set (3 Pole, 2 m) .....	1

### **WARNING**

**This device contains high-voltage parts. Never remove the cover.**

**The internal parts of this device must only be serviced by an engineer who has a thorough understanding of risk prevention.**

### ■ Contents of CD-ROM supplied

#### • Application software

Main settings of **ZM2371 / ZM2372**, acquisition and display of measured data, measurement and setting by sweeping the frequencies, and saving of measured data can be performed.

#### • LabVIEW driver

The LabVIEW instrument driver that handles the **ZM2371 / ZM2372** main commands and query is provided.

#### • Sample programs

An example of control of **ZM2371 / ZM2372** is shown using each interface of USB, GPIB, and RS-232 in each programming language of C# and VB.NET.

This chapter describes the outline only. For detailed contents and handling method, refer to the instructions stored in the CD-ROM.

## ■ Signal cables

Since the signal cables are not supplied, please purchase commercially available cables. The cable specifications are as follows.

- **DUT connection cable**

Coaxial cable having BNC connector

To correct the cable length exactly, use a coaxial cable (capacitance about 100pF/m) of characteristic impedance 50Ω.

- **USB cable**

Cable that conforms to the USB 1.1 or USB 2.0 Standard

- **RS-232 cable**

Interlink cable with D-Sub 9 pins, female-female, inch screws, and shield

The controllers other than general personal computers have different connector or signal assignment and may require a dedicated cable.

- **GPIB cable**

Cable that conforms to the IEEE488.1 Standard

## ■ Relevant products

Since the test fixture and test lead are not supplied, please purchase them additionally.

<b>2323A</b>	Direct-coupled type test fixture (for parts with lead, 4-terminal connection)
<b>2324</b>	4-terminal alligator clip test lead
<b>ZM2391</b>	3-terminal alligator clip test lead
<b>2325AL</b>	Kelvin clip test lead (large-sized clip)
<b>2325AM</b>	Kelvin clip test lead (medium-sized clip)
<b>ZM2392</b>	Kelvin clip test lead
<b>2326A</b>	Test lead for chip part (tweezers type, 2-terminal connection)
<b>ZM2393</b>	Chip test fixture (direct-coupled type, for side electrode parts, 2-terminal connection)

The **2326A**, **ZM2391**, and **ZM2393** are connected to the DUT with two terminals, and therefore the contact resistance and its variations will affect the measurement. For the measurement of 100Ω or less, an additional error should be evaluated before use of the product.

The information given here is as of the preparation of this Instruction Manual. Relevant products are subject to change, abolition, or addition without notice. Be sure to contact NF Corporation or one of our representatives for confirmation when ordering them.

---

## 2.2 Installation

### 2.2.1 General Precautions for Installation

---

#### ⚠ CAUTION

Take the following precautions to prevent damage to ZM2371 / ZM2372.

- **ZM2371 / ZM2372 is cooled by forced air-cooling.**  
Do not block the air inlet on both side panels and the air outlet on the rear panel.
  - **The ZM2371 / ZM2372 must be installed horizontally (with the bottom panel facing the floor). Using the device with the rear panel or side panel facing downward (in the upright position) causes the device to be toppled down easily, leading to a danger.**
- 

#### ■ Handling of the panel and case

The front panel of **ZM2371 / ZM2372** is made of plastic. It can be damaged by sharp or hot tools. When the case/panel surface needs cleaning, wipe with a soft cloth. To remove persistent contamination, wipe with a soft cloth soaked with neutral detergent and wrung out. Do not use any organic solvents like thinner or benzene, or any chemical cleaning cloth, as they may cause the surface finish to deteriorate, tarnish, or come off.

### 2.2.2 Installation Conditions

Install **ZM2371 / ZM2372** in a location that fills the following temperature and humidity requirements.

Operation: 0 to +40°C, 5 to 85% RH (where absolute humidity is 1 to 25g/m<sup>3</sup>, non-condensing)

Storage: -10 to +50°C, 5 to 95% RH (where absolute humidity is 1 to 29g/m<sup>3</sup>, non-condensing)

---

#### ⚠ CAUTION

Do not install the device in locations such as:

- **location with direct sunlight or with a nearby source of heat**
  - **location with significant amounts of dust, salt, metallic powders**
  - **location with significant amounts of corrosive gases, vapor, soot**
  - **location exposed to excessive vibration**
  - **location close to a strong magnetic or electromagnetic field source**
  - **location close to a pulsing noise source**
- 

If the measurement accuracy is important, warm up the device for more than 30 minutes before use. Ensure adequate distance between power cable of **ZM2371 / ZM2372** or other devices and signal cable. Close distance between power cable and signal cable may cause measurement dispersions due to a malfunction or noise.



---

### 2.2.3 Rack Mounting

**ZM2371 / ZM2372** can be mounted on a 19-inch IEC rack, an EIA specification rack or a JIS standard rack by the use of a rack-mount adapter (optional). The rack-mount adapter is available with metric type and inch type.

First, mount the rack-mount adapter on the device as shown in “**Fig. 2-1 Rack-mount assembly (mm-rack)**” or “**Fig. 2-2 Rack-mount assembly (inch-rack)**”, and then, mount the device on the rack.

---

#### **WARNING**

**When mounting the device on the rack, be sure to install rack rails to support the ZM2371 / ZM2372. Otherwise, ZM2371 / ZM2372 may fall, causing a human injury or product damage.**

---

---

#### **CAUTION**

- **Make sure that the rack is sufficiently air-cooled by providing appropriate ventilation ports or cooling fans.**
- **The air inlet of ZM2371 / ZM2372 is provided on both side panels. Ensure 20mm or more clearance between side panel and wall.**
- **The air outlet is provided on the rear panel. Ensure 50mm or more clearance between rear panel and wall.**

**Higher ambient temperature than the specification or blocking the air inlet or outlet may reduce the performance or damage the ZM2371 / ZM2372.**

---

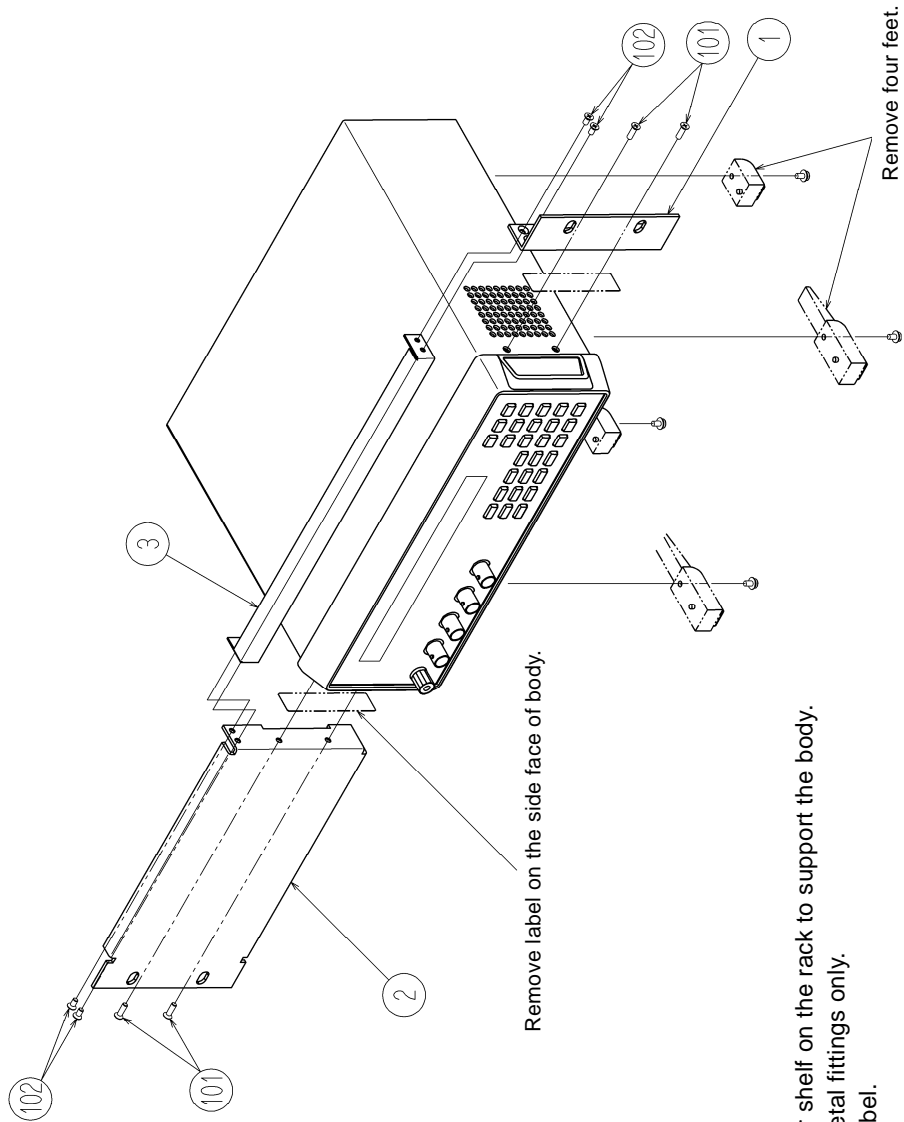

Part No.	Part name	Qty.
1	Rack-mount R	1
2	Rack-mount L	1
3	Panel spacer	1
101	Countersunk screw M3 x 10	4
102	Countersunk screw M3 x 6	4

**⚠ Caution**

When mounting on the rack, install angles or shelf on the rack to support the body.  
 Do not hold the device by the rack-mount metal fittings only.  
 Do not use the removed feet, screws, and label.

**Figure 2-1 Rack-mount assembly (mm-rack)**

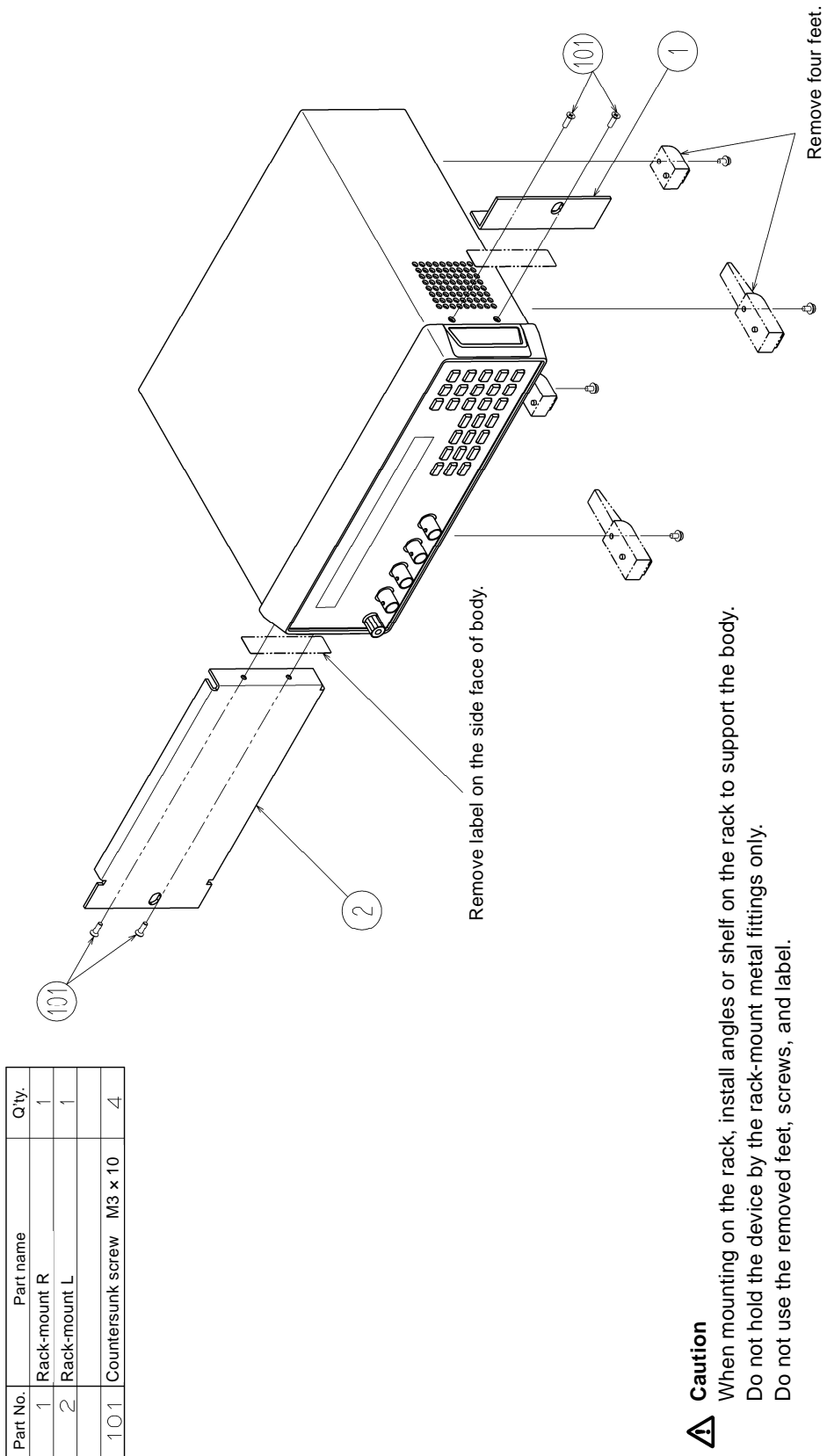
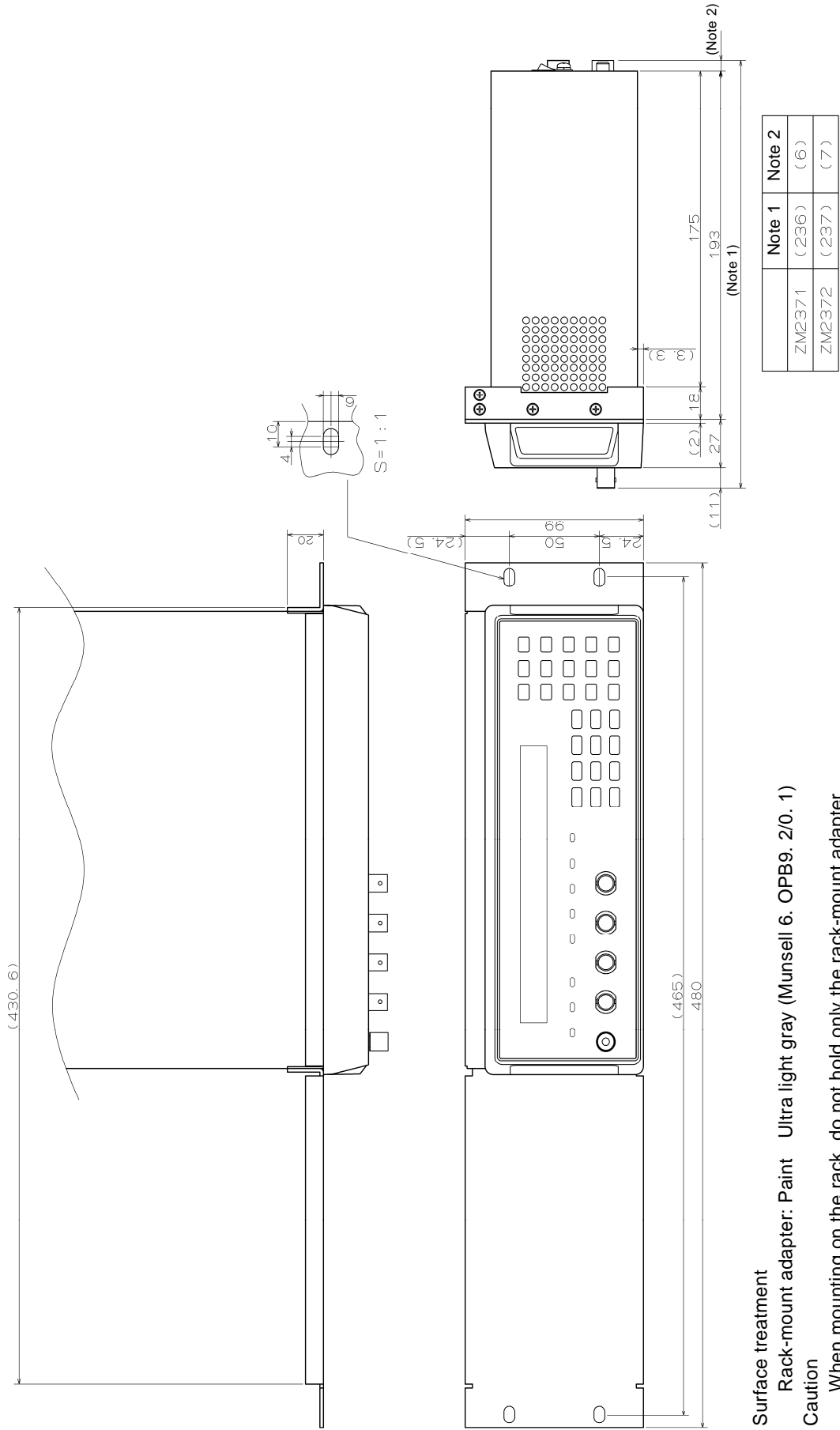
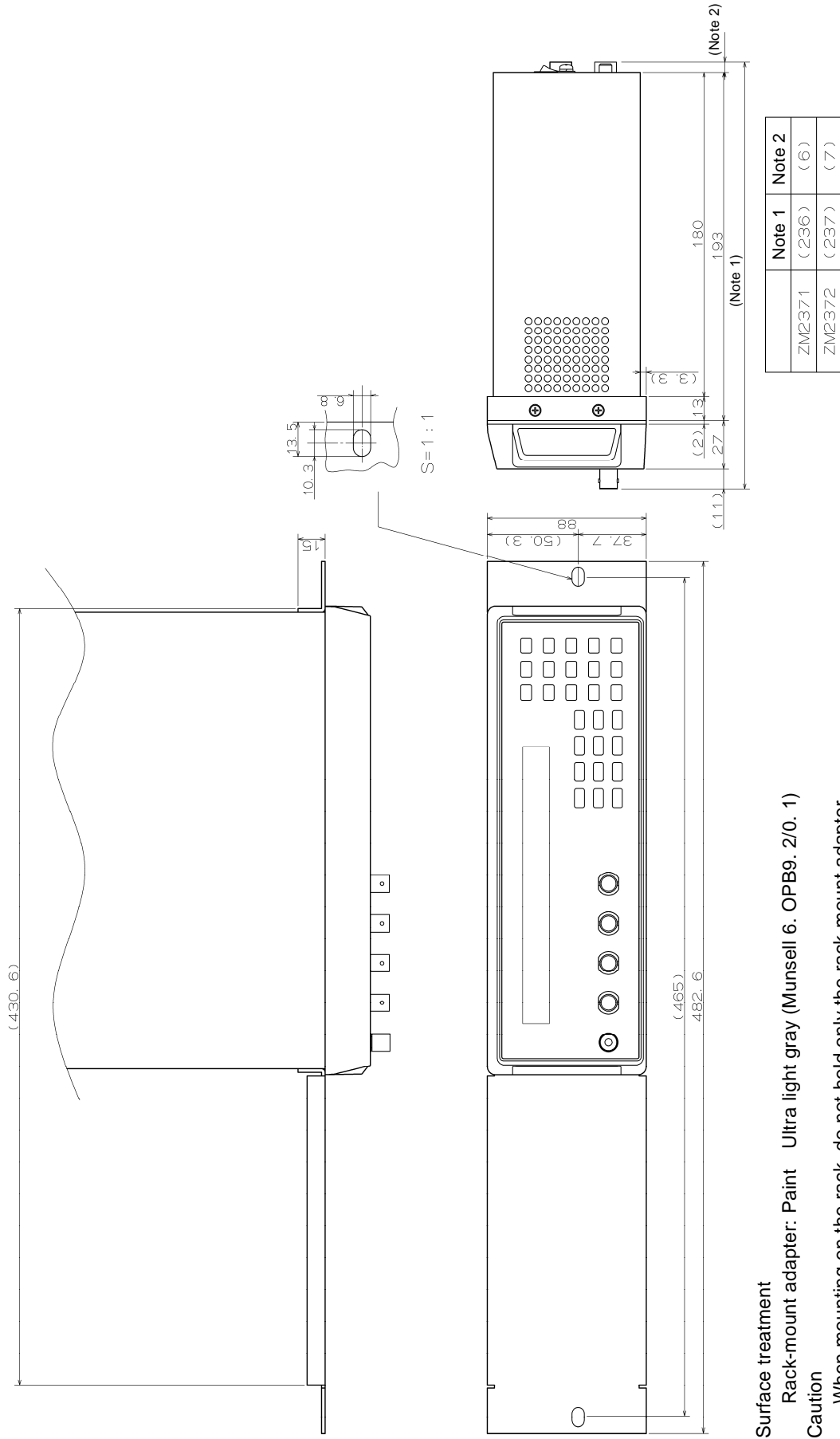

Figure 2-2 Rack-mount assembly (inch-rack)



Surface treatment  
 Rack-mount adapter: Paint Ultra light gray (Munsell 6. OPB9. 2/0. 1)  
 Caution  
 When mounting on the rack, do not hold only the rack-mount adapter.  
 Make sure that the rack uses L metal fittings or shelves to hold the body.

Figure 2-3 Size and dimensions of the rack-mount (mm-rack)



Surface treatment  
 Rack-mount adapter: Paint Ultra light gray (Munsell 6. OPB9. 2/0. 1)  
 Caution  
 When mounting on the rack, do not hold only the rack-mount adapter.  
 Make sure that the rack uses L metal fittings or shelves to hold the body.

Figure 2-4 Size and dimensions of the rack-mount (inch-rack)

## 2.3 Grounding and Power Supply Connection

### ■ Grounding

---

#### WARNING

Take the following precautions to avoid risk of electric shock.

Before connecting the device for measurement, make sure the protective grounding terminal is grounded.

The protective grounding terminal for ZM2371 / ZM2372 is the grounding pin of the three-pole power cord. Make sure you insert the power cord's plug into a three-pole power outlet with a protective grounding contact.

---

### ■ Power Supply

---

#### CAUTION

Before connecting the power supply, make sure that the voltage of power outlet is within the power voltage range of the specifications. Otherwise, the ZM2371 / ZM2372 may be damaged.

---

ZM2371 / ZM2372 operates with the following commercial power supply.

Power voltage range: 100 to 230VAC  $\pm 10\%$ , not exceeding 250VAC

Power frequency range: 50Hz/60Hz  $\pm 2\text{Hz}$

Maximum power consumption is 70VA (ZM2371) or 75VA (ZM2372).

The power switch of ZM2371 / ZM2372 is located on the rear panel.

Make sure that the power switch is set to OFF before connecting the power cord.

After powering off the device, make sure to wait for at least five seconds before powering on again.

---

#### WARNING

This device contains high-voltage parts. Never remove the cover.

---

---

#### CAUTION

The power cord set supplied conforms to the Electrical Appliance and Material Safety Law and it is dedicated for use in Japan. It cannot be used for power voltage exceeding 125V AC, for countries other than Japan, or for other devices.

---

Please contact NF Corporation or one of our representatives when the device is used with the power voltage exceeding 125V AC or in the countries other than Japan.

## 2.4 Simplified Operation Check

Before an important measurement or after a long unused time of device, it is recommended to check the **ZM2371 / ZM2372** operation by the following procedure. Check it within an application range.

1. Plug the power cord in the AC outlet and turn on the power switch on the rear panel.  
Wait until the starting message disappears and the measurement screen is displayed.
2. Initialize the settings.  
Press **[SHIFT]** + **[INIT]** keys to display the initialize menu, and press **[1]** key.  
(First press **[SHIFT]** key, and then press **[0]** | **[INIT]** key where INIT is written in upper place.)
3. Connect the test fixture or test lead to the measurement terminal on the front panel.
4. Attach the DUT to the test fixture or test lead.  
Prepare the DUT of which value is known exactly every measurement range used. For 1k $\Omega$  range, for instance, a value of about 1k $\Omega$  will be appropriate.
5. Switch the measurement conditions, and check that the measurement can be performed normally.  
**[FREQ]** key : Display the measurement frequency setting menu and set the frequency.  
**[LEVEL]** key : Display the measurement signal level setting menu and set the voltage.

-- Evaluation of measured result --

The measured value may vary depending on the connection method or whether open and short are corrected or not, and accordingly an error due to these factors should be taken into consideration. Also, as the impedance of DUT itself may vary depending on the frequency or signal level, the DUT's characteristics should be checked in advance.

6. Check the triggered drive timing (if used).  
Press **[SHIFT]** + **[TRIG MODE]** keys to display the trigger setting menu, and press **[1]** key to set the trigger source to Manual.  
Press **[SHIFT]** + **[TRIG MODE]** keys to display the trigger setting menu, and press **[5]** key to select S.Sync. Further, press **[1]** key to select ON, so as to make the triggered drive valid, and then press **[EXIT]** key to return to the measurement screen (**[EXIT]** key: **[ENTER]** | **[EXIT]** key where EXIT is written in lower place).  
Attach the DUT to the test fixture, and observe the signal of the H terminal with an oscilloscope.  
Press **[TRIG]** key to check that the drive signal is output only at the measurement.
7. Check the contact check function (if used, **ZM2372** only).  
Connect the Kelvin clip test lead, and press **[SHIFT]** + **[CONTACT]** keys, and then **[1]** key to make the contact check valid. Check that the display of measured value becomes **NC** when two **H** terminals are opened. Check the **L** terminals similarly.

Thus, the simplified operation check is completed.

Finally, it is recommended to initialize the settings.

## 2.5 Calibration

Ensure that **ZM2371 / ZM2372** undergoes the test described in “**8.7 Performance Testing**” at least once a year, depending on the use environment and use frequency.

It is recommended to conduct a performance test before using it for an important measurement or test.

If the performance test does not produce satisfying results, NF Corporation will make the necessary adjustment or calibration to restore performance.

When the calibration or adjustment is necessary, please contact NF Corporation or one of our representatives.

You will be liable for the costs of calibration or adjustment.



# 3. PANEL FEATURES AND BASIC OPERATIONS

3.1	Panel Component Names and Functions .....	3-2
3.2	Display at Power “ON” and Initial Setting .....	3-4
3.2.1	Check before Power “ON” .....	3-4
3.2.2	Displays and Indications at Power “ON” .....	3-5
3.2.3	Initialization .....	3-6
3.3	Operation Tree .....	3-10
3.4	Connection of DUT .....	3-13
3.4.1	Measurement Terminals .....	3-13
3.4.2	Connection to DUT .....	3-14
3.4.3	Precautions on Connection .....	3-15
3.5	Basic Operations .....	3-17
3.5.1	Outline of Measurement Screen .....	3-17
3.5.2	Basic Key Operations .....	3-18
3.5.3	Simplified Operating Method When You Use Device for the First Time .....	3-21
3.5.4	Initialization .....	3-25
3.5.5	Setting of Measurement Parameters .....	3-26
3.5.5.1	Selection of Primary Parameters .....	3-26
3.5.5.2	Setting of Equivalent Circuit .....	3-28
3.5.5.3	Setting of Secondary Parameters .....	3-29
3.5.6	Setting of Basic Measurement Conditions .....	3-31
3.5.6.1	Measurement Frequency .....	3-31
3.5.6.2	Measurement Signal Level .....	3-32
3.5.6.3	Measurement Range .....	3-35
3.5.6.4	Trigger .....	3-38
3.5.6.5	Measurement Speed .....	3-42
3.5.6.6	Correction of Measurement Error .....	3-44
3.5.6.7	OPEN Correction .....	3-45
3.5.6.8	SHORT Correction .....	3-50
3.5.6.9	LOAD Correction .....	3-53
3.5.6.10	Cable Length Correction .....	3-57

### 3.1 Panel Component Names and Functions

This section describes the names and functions of the components on the front and rear panel of **ZM2371 / ZM2372**.

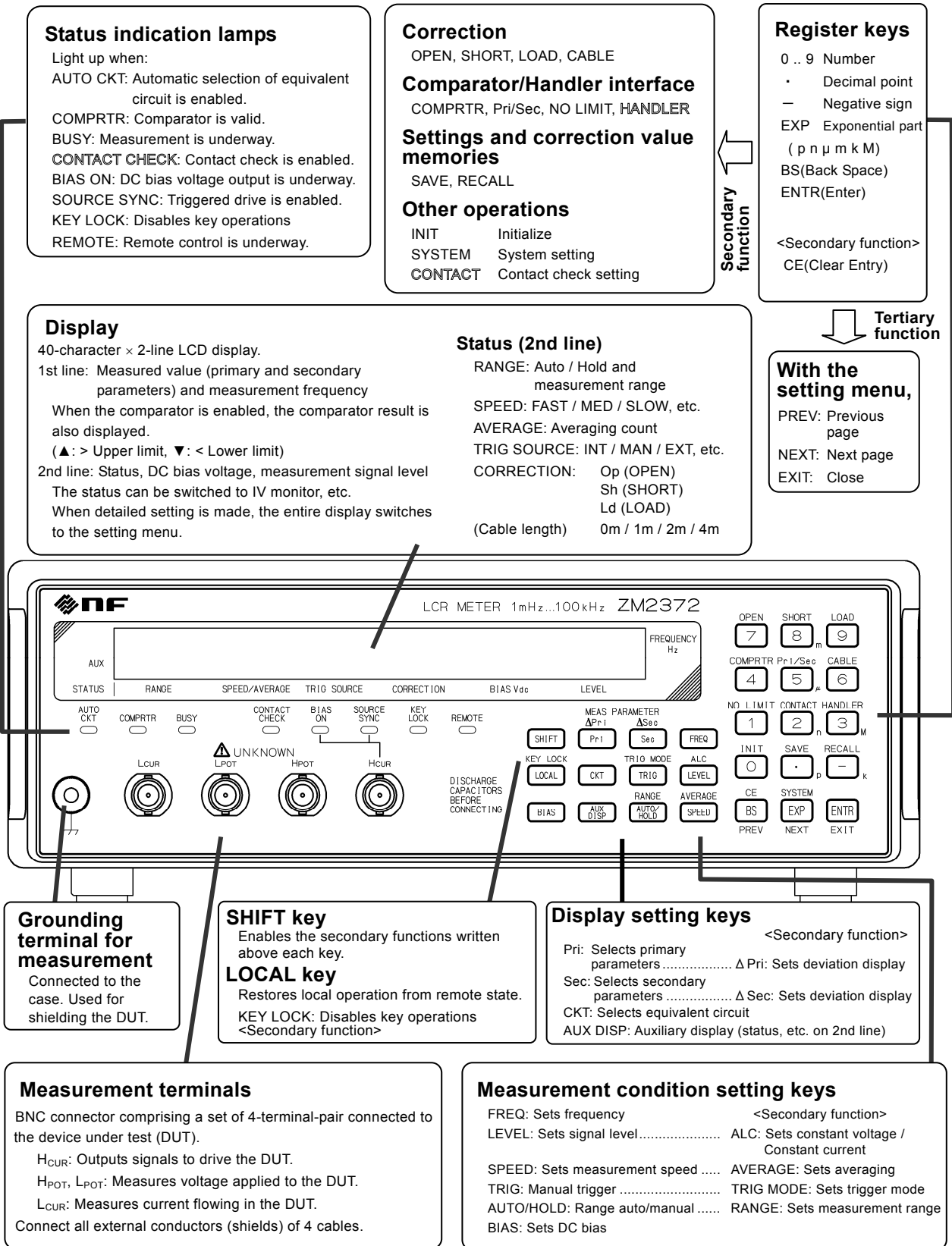

Figure 3-1 Front panel

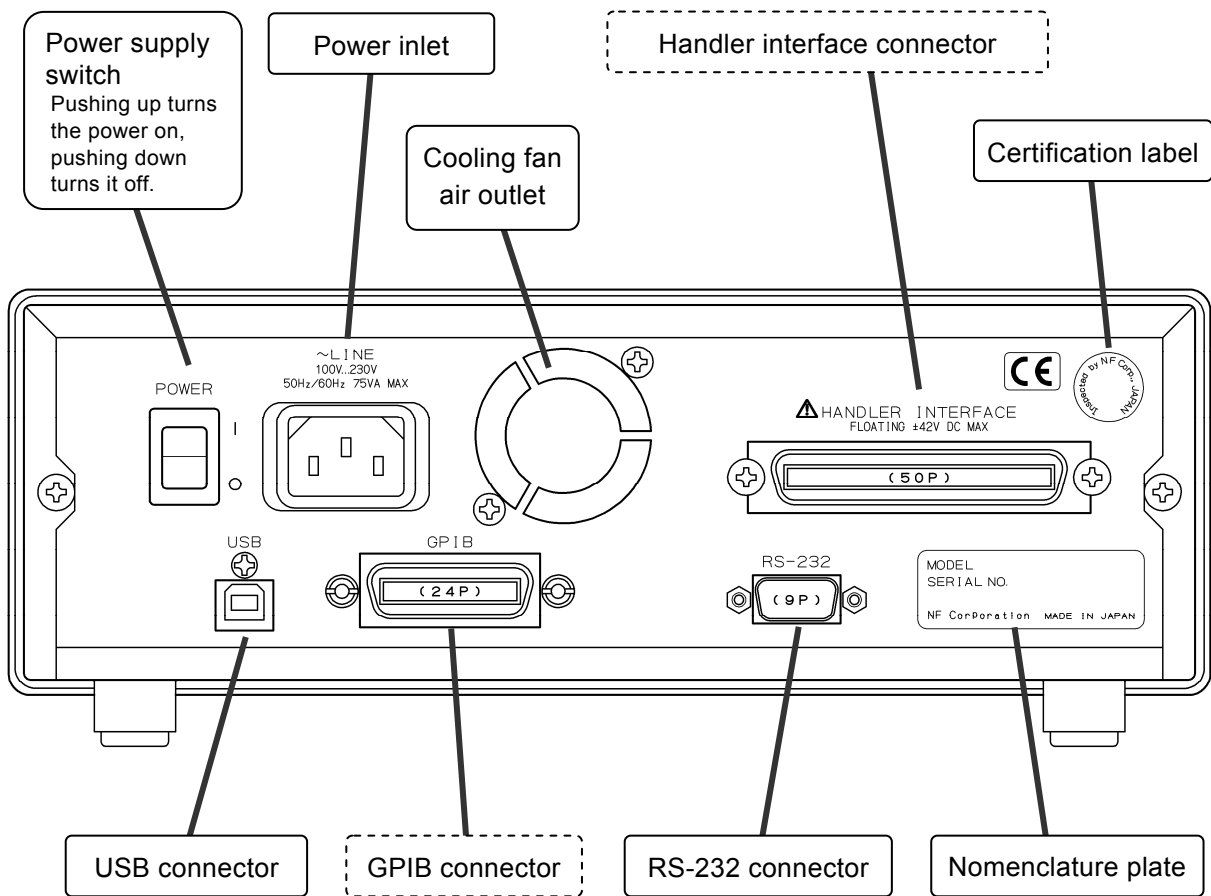

Figure 3-2 Rear panel

Note: This chapter shows the front panel and rear panel of the **ZM2372**.

The **ZM2371** does not have the handler interface, GPIO, and contact check function. Accordingly, the connectors, labels on the panel, and indication lamps related to these features are not provided. In the figures, the description about these features is expressed with a dashed line ----- or outline characters ⚠.

When a schematic view of front panel or rear panel is shown in the following descriptions, the **ZM2372** panel is used as a representative.

## 3.2 Display at Power “ON” and Initial Setting

### 3.2.1 Check before Power “ON”

**ZM2371 / ZM2372** operates with the following commercial power supplies.

Power voltage range: 100 to 230VAC  $\pm 10\%$ , not exceeding 250VAC

Power frequency range: 50Hz/60Hz  $\pm 2\text{Hz}$

The power consumption is 70VA or less (**ZM2371**), or 75VA or less (**ZM2372**).

---

#### **WARNING**

**Take the following precautions to avoid accidents due to electric shock.**

**Before connecting the device for measurement, make sure the protective grounding terminal is grounded.**

**The protective grounding terminal for ZM2371 / ZM2372 is as three-pole power cord grounding pin.**

**Make sure you insert the power cord’s plug into a three-pole power socket with protective-grounding.**

---

---

#### **CAUTION**

**Make sure to connect to the power socket after checking that the power voltage is within the specified range for the ZM2371 / ZM2372. Otherwise, ZM2371 / ZM2372 may be damage.**

---

Make sure that the power switch is set to OFF before connecting the power cord.

After turning the power off, make sure to wait for at least 5 seconds before turning it on.

---

#### **CAUTION**

**Wait at least 5 seconds between each power activation/deactivation.**

**Turning the power on and off in a very short span of time may cause the device to not work properly.**

---

Turn the power on according to the following procedure.

- Make sure that the power switch is OFF (turned downward).
- Connect the power cord to the power inlet at the back of the device.
- Insert the power cord’s plug to a three-pole power socket.
- By switching the power switch upward the **ZM2371 / ZM2372** is turned on.

When the power switch is turned on, a starting message is displayed and then the device becomes ready for measurement.

Display at launch  **“3.2.2 Displays and Indications at Power “ON” ”**

### 3.2.2 Displays and Indications at Power “ON”

Take necessary steps before instrument usage/operation according to “**2. PREPARATIONS BEFORE USE**”.

When the power switch is turned on, a test pattern is displayed, and then a starting message including the model name “**ZM2371**” or “**ZM2372**” and firmware version is displayed (see below).

**Example:**

<b>Z M 2 3 7 2</b>
<b>V 1 . 0 0    2 0 0 9 / 6 / 1 5   1 6 : 2 7</b>

Version      Last adjustment date and time

Also, all lamps light up. During this time, the self diagnosis is conducted. If an error is found, an error message is displayed.

For details      ☞ “**7.1.1 Errors at Power-On**”

If a serious error is found, the device will no longer operate with an error message displayed.

When a setting or correction value has been lost, an error message is displayed but the parameter for which the error occurred is initialized and started. This error message can be reset by pressing any key.

Initialization contents      ☞ “**3.2.3 Initialization**”

The settings and correction values at the time when the power was turned off last are resumed unless the resume memory that saves last settings is normal.

### 3.2.3 Initialization

ZM2371 / ZM2372 is reset to the factory default settings in the following cases:

- **At the time of shipment from factory**  
All settings and correction values including operation modes and memory contents are set to the initial values.
- **When full initialization of settings is specified**  
Except operation modes, the memory contents, settings, and correction values are reset to the factory default settings.  
☞ “4.10 Initialization of All Settings”
- **At the power ON, if backed up setting or correction value is faulty**  
Faulty part is initialized.  
☞ “3.2.2 Displays and Indications at Power “ON” “
- **When operation mode is switched**  
The settings and correction values except operation modes are all initialized including memory contents.  
In general, the initial values vary depending on the operation modes.  
For the operation modes other than standard operation mode (MODE 0), see Chapter 6.

To start the operation from the initial setting state, perform initialization as follows:

- After pressing **[SHIFT]** key, press **[0]** | **[INIT]** key to display the initialize menu, and press **[1]** key.

Initialized items, initialized contents ☞ “Table 3-1 Setting items and initial values”

Table 3-1 Setting items and initial values 1/3

Setting items	Parameter range	Initial values	INIT	*RST	Setting memory	Resume
<b>&lt;Measurement range (including Rdc)&gt;</b>						
Automatic selection	OFF(HOLD)   ON	ON	←	←	○	○
Range	100mΩ to 1MΩ	100Ω	←	←	○	○
<b>&lt;Measurement signal&gt;</b>						
Frequency	1m to 100kHz	1kHz	←	←	○	○
Measurement signal level (voltage)	0.01 to 5Vrms	1Vrms	←	←	○	○
Constant voltage drive (CV)	OFF   ON	OFF	←	←	○	○
Minimum output impedance	5   25 Ω	25Ω	←	←	○	○
Constant current level	1μ to 200mArms	1mArms	←	←	○	○
Constant current drive (CC)	OFF   ON	OFF	←	←	○	○
Internal DC bias voltage	0 to 2.50V	0V	←	←	○	○
Internal DC bias output	OFF   ON	OFF	←	←	×	×
Triggered drive	Continuous   Sync.	Continuous	←	←	○	○
<b>&lt;Measurement speed&gt;</b>						
	RAP   FAST   MED   SLOW   VSLO	MED	←	←	○	○
<b>&lt;Trigger&gt;</b>						
Trigger source	INT   MAN   EXT   BUS	INT (internal)	←	←	○	○
Trigger delay time	0 to 999.999 s	8ms	←	←	○	○
Continuous start	OFF   ON	ON	←	OFF	×	×
<b>&lt;Contact check (ZM2372 only)&gt;</b>						
Contact check	OFF   ON	OFF	←	←	○	○
Real time check	OFF   ON	ON	←	←	○	○
<b>&lt;Correction lower limit frequency&gt;</b>						
	1m to 1kHz	40Hz	←	←	○	○
<b>&lt;SPOT correction&gt;</b>						
	OFF   ON	OFF	←	←	○	○
<b>&lt;OPEN correction&gt;</b>						
ON/OFF	OFF   ON	OFF	←	←	○	○
Correction value (Primary & Secondary parameters)	±9.99999E+11 Y conversion	(0, 0)	←	←	△	○
Format of correction value	G-B   Cp-G	G-B	←	←	○	○
<b>&lt;SHORT correction&gt;</b>						
ON/OFF	OFF   ON	OFF	←	←	○	○
Correction value (Primary & Secondary parameters)	±9.99999E+11 Z conversion	(0, 0)	←	←	△	○
Format of correction value	Rs-X   Ls-Rs	Rs-X	←	←	○	○
<b>&lt;LOAD correction&gt;</b>						
ON/OFF	OFF   ON	OFF	←	←	○	○
Format of standard value / correction value	Cp-D   Cs-D   Rp-Cp   Rs-Ls   Rs-X   Z-θ	Rs-X	←	←	○	○
Correction value (Primary & Secondary parameters)	±9.99999E+11	1, 0	←	←	△	○
Standard value (Primary & Secondary parameters)	±9.99999E+11	1, 0	←	←	○	○
<b>&lt;Cable length&gt;</b>						
	0   1   2   4 m	0m	←	←	○	○
<b>&lt;Averaging&gt;</b>						
ON/OFF	OFF   ON	OFF	←	←	○	○
Count	1 to 256	1	←	←	○	○

### 3.2 Display at Power "ON" and Initial Setting

**Table 3-1 Setting items and initial values 2/3**

Setting items	Parameter range	Initial values	INIT	*RST	Setting memory	Resume
<b>&lt;Measured data&gt;</b>						
Measurement parameter automatic selection	OFF   ON	ON	←	←	○	○
Kind of primary parameters	L   C   R   Z   Y   G (   REAL   MLIN)	C	←	←	○	○
Equivalent circuit (primary parameter)	Series   Parallel	Parallel	←	←	○	○
Equivalent circuit automatic selection	ON   OFF	ON	←	←	○	○
Kind of secondary parameters	Q   D   θ   X   B   R <sub>s</sub>   R <sub>p</sub>   G   L <sub>p</sub>   R <sub>dc</sub> (   IMAG   REAL)	D	←	←	○	○
Primary parameter deviation display format	Deviation   Deviation %	Deviation	←	←	○	○
Primary parameter deviation display	OFF   ON	OFF (ABS)	←	←	○	○
Primary parameter reference value	±9.99999E+11	0	←	←	○	○
Secondary parameter deviation display format	Deviation   Deviation %	Deviation	←	←	○	○
Secondary parameter deviation display	OFF   ON	OFF (ABS)	←	←	○	○
Secondary parameter reference value	±9.99999E+11	0	←	←	○	○
Multiple measurements	OFF   ON	OFF	←	←	○	○
Measurement function	FIMP   FADM, etc.	FIMP	←	←	○	○
<b>&lt;Comparator&gt;</b>						
Comparator function	OFF   ON	OFF	←	←	○	○
BIN1 sorting	OFF   ON	ON	←	←	○	○
BIN2..14 sorting	OFF   ON	OFF	←	←	○	○
Comparison of secondary parameter	OFF   ON	ON	←	←	○	○
Primary parameter upper limit (value, ON/OFF)	±9.99999E+11, OFF   ON	0, OFF (No Limit)	←	←	○	○
Primary parameter lower limit (value, ON/OFF)	±9.99999E+11, OFF   ON	0, OFF (No Limit)	←	←	○	○
Secondary parameter upper limit (value, ON/OFF)	±9.99999E+11, OFF   ON	0, OFF (No Limit)	←	←	○	○
Secondary parameter lower limit (value, ON/OFF)	±9.99999E+11, OFF   ON	0, OFF (No Limit)	←	←	○	○
Primary parameter comparison format	Absolute value   Deviation   Deviation %	Absolute value	←	←	○	○
Primary parameter deviation comparison reference value	(Common to deviation display)	0	←	←	○	○
<b>&lt;Limit comparison &gt;</b>						
Primary parameter limit comparison	OFF   ON	OFF	←	←	○	○
Secondary parameter limit comparison	OFF   ON	OFF	←	←	○	○
<b>&lt;Handler interface&gt; (ZM2372 only)</b>		(Fixed to initial value for ZM2371)				○
AUX BIN function	OFF   ON	OFF (Include)	←	←	○	○
Bin extension BIN10..14	OFF   ON	OFF	←	←	○	○
TRIG polarity	Positive   Negative	Positive	×	×	×	◎
Settings & correction value memory recall target	Settings   Correction values   Both	Settings	←	←	○	○
<b>&lt;Beeper&gt;</b>						
Sounding selection	OFF   ON	OFF	←	←	○	○
Sounding condition	FAIL   PASS	FAIL	←	←	○	○
<b>&lt;Auxiliary display&gt;</b>		Status   BINn-Limit   Sec-Limit   Pri&Sec-REF   IV Monitor	←	←	○	○



Table 3-1 Setting items and initial values 3/3

Setting items	Parameter range	Initial values	INIT	*RST	Setting memory	Resume
<Data transfer format>	ASCII   Real (binary)   Packed	ASCII	←	←	×	×
< Measured data buffer>						
BUF1, BUF2 data	Primary parameter   Secondary parameter   None	None, None	←	←	×	×
BUF1, BUF2, BUF3 feed	Send   Not send	Not send (all)	←	←	×	×
BUF1, BUF2, BUF3 size	1 to 200, 1 to 200, 1 to 1000	200,200,1000	←	←	×	×
<Key lock>	OFF   ON	OFF	←	←	×	×
<Interface>						
Type	USB   RS232   GPIB (GPIB is for ZM2372 only)	USB	×	×	×	◎
GPIB address	0 to 30	2	×	×	×	◎
RS-232 bit rate	4800 to 230400	9600	×	×	×	◎
RS-232 terminator	CR   LF   CR LF	CR LF	×	×	×	◎
RS-232 handshake	OFF   SOFT   HARD	OFF	×	×	×	◎
<Settings & correction value memories>						
Contents	—	Empty (no saving)	×	×	—	—
Recall target (excluding the designation from handler interface)	Settings   Correction values   Both	Settings	←	←	○	○
<Operation mode>	Mode 0   1	Mode 0	×	×	×	◎

### ■ Remarks

Initial values Set when device is shipped from factory, or when full initialization is executed with the system setting menu.

INIT Set when initialization is executed with the initialize menu (**SHIFT** + [INIT]).

\*RST Set when \*RST command of remote control is executed

← Same as left (initial values)

△ Function provided. However, it is saved not in the settings memory but in the correction value memory.

× Function not provided. (No influence)

○ Function provided.

◎ Function provided. However, it is saved independently from general resume target (○).

It cannot be set/query by the remote control.

The followings are out of the resume target:

- Measured data saved in the measured data buffer
- Latest measured data
- Range selected automatically
- Measurement parameters selected automatically
- Equivalent circuit selected automatically

### 3.3 Operation Tree

An operation tree when **ZM2371 / ZM2372** is operated from the panel is shown below.  
For the expression of operations, see “**3.5.2 Basic Key Operations**”.

#### Operation Tree (1/3)

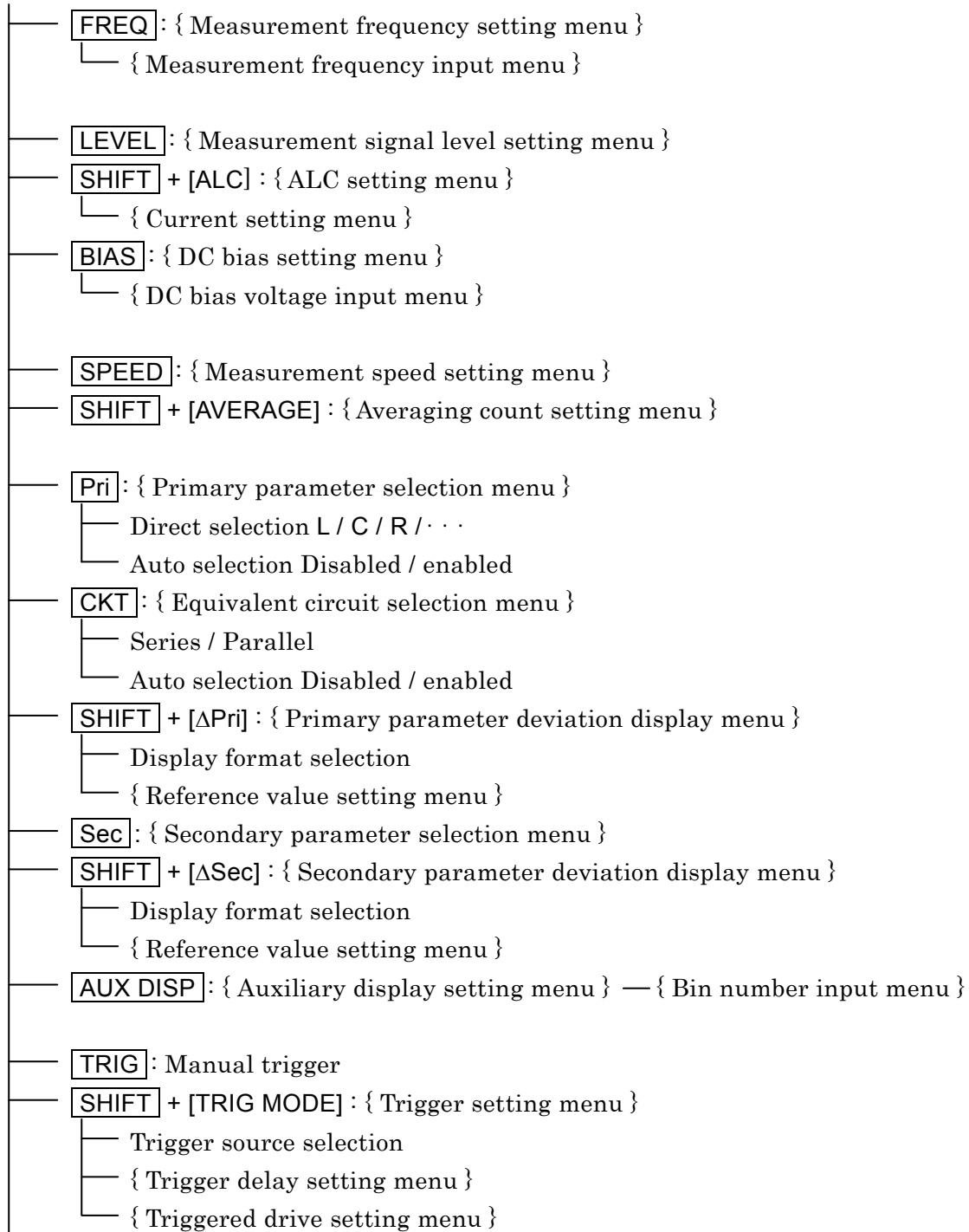

Continued

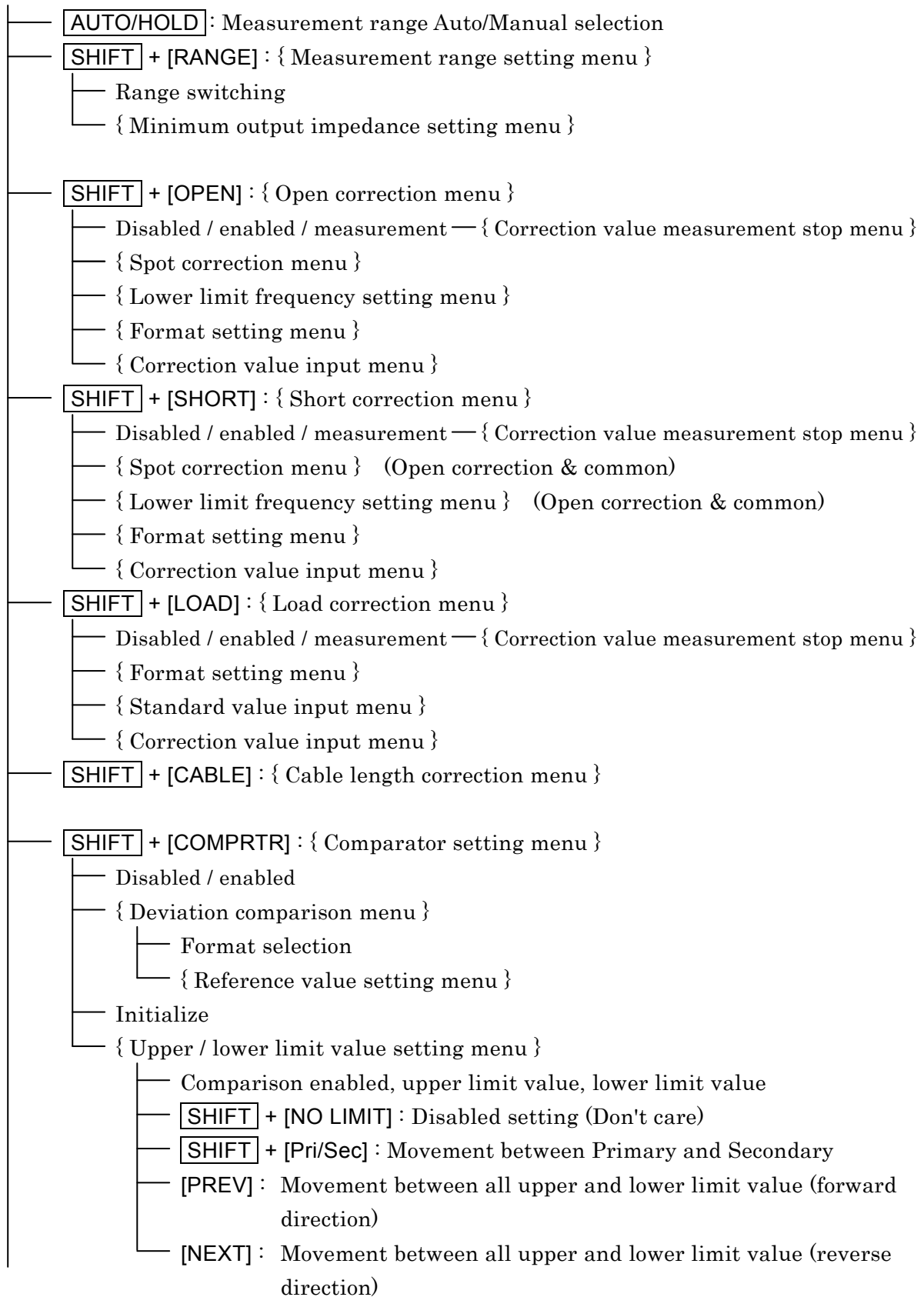

Continued

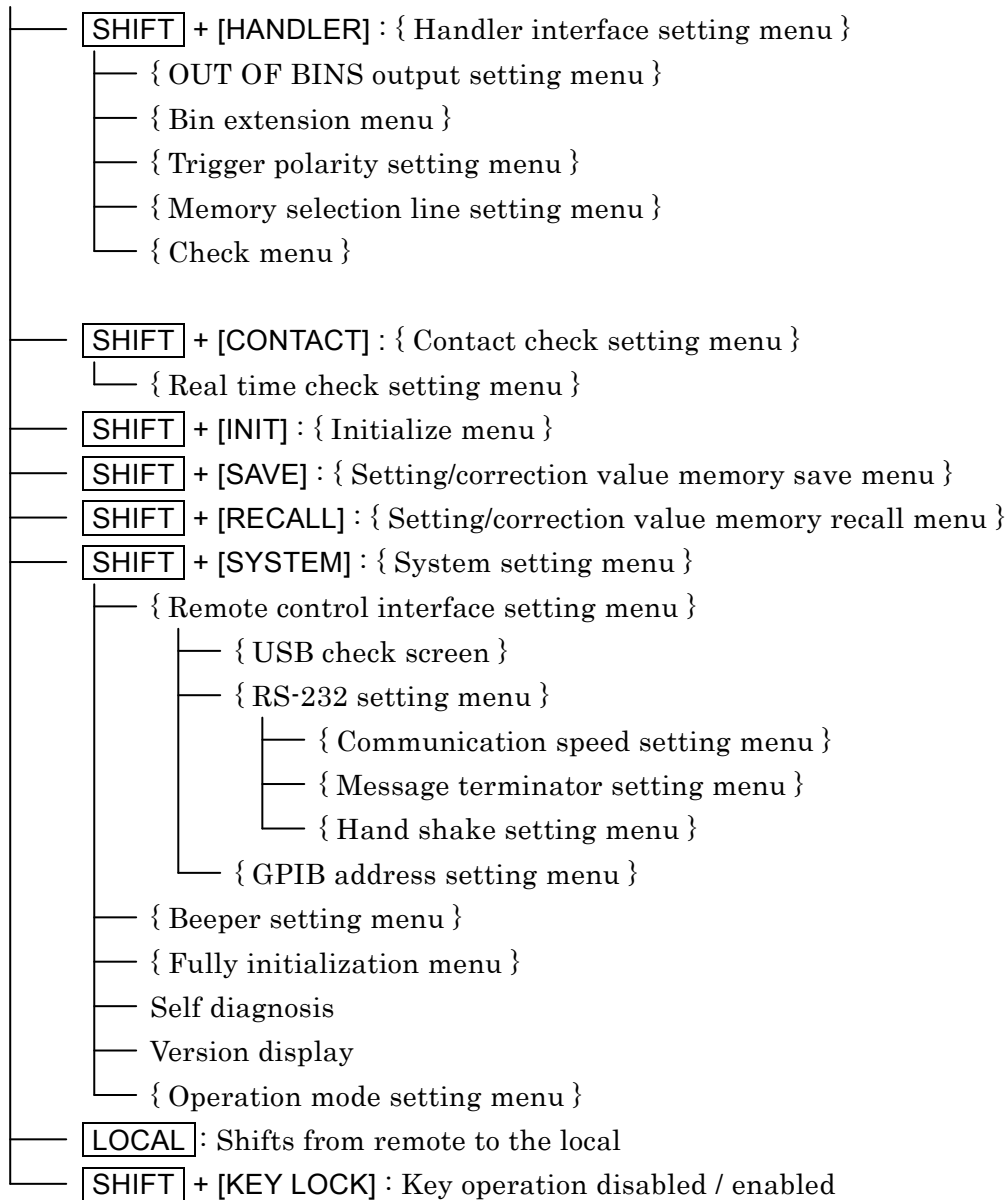

## 3.4 Connection of DUT

### 3.4.1 Measurement Terminals

#### ■ Description of each terminal

H <sub>CUR</sub>	Outputs the signal to drive the DUT.
H <sub>POT</sub>	Measures the voltage applied to the DUT.
L <sub>POT</sub>	Measures the voltage applied to the DUT.
L <sub>CUR</sub>	Measures the current flowing in the DUT.
	Grounding terminal to guard the DUT

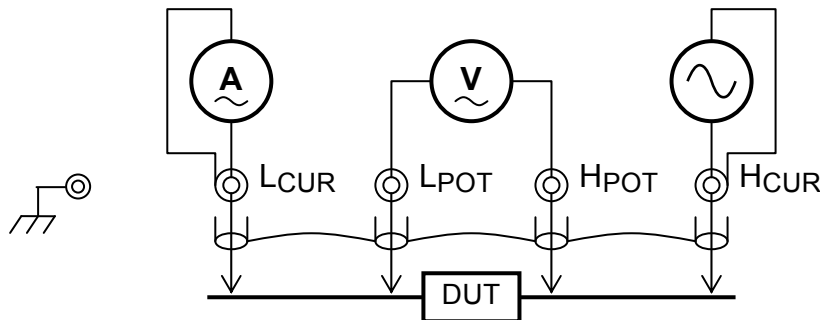

Connect total four outer conductors (shields) of each terminal together. Be sure to connect outer conductors (shields) of H<sub>CUR</sub> and L<sub>CUR</sub> terminals, since the signal currents return through these conductors.

Figure 3–3 Functions of measurement terminals

#### ■ Measurement terminals when power is OFF

Even when the power is in OFF state, the measurement terminals are connected to internal circuits.

#### WARNING

The measurement category of measurement terminals L<sub>CUR</sub>, L<sub>POT</sub>, H<sub>POT</sub>, H<sub>CUR</sub> of the ZM2371 / ZM2372 is CAT I. Do not connect them directly to the power lines of power outlet, distribution board, or inside a device. Also, do not apply voltage exceeding 42Vpk to the grounding. Otherwise, you may get a shock or the ZM2371 / ZM2372 may be damaged.

#### CAUTION

Do not give signals from outside to the measurement terminals.  
Do not give signals from outside even when the power is OFF.  
Otherwise, the ZM2371 / ZM2372 may be damaged.

#### CAUTION

Do not connect the charged capacitor.  
When the DUT could have been charged, discharge the DUT completely before connection.  
Discharging the DUT to the measurement terminals may damage the ZM2371 / ZM2372.

### ■ Measurement signals

Main specifications of measurement signals are as follows:

Signal level	Voltage:	10mVrms to 5Vrms (ALC possible)
	Constant current:	1 $\mu$ Arms to 200mArms (range depends on measurement range, etc.)
	Max. about	7.1Vpk voltage including DC bias is output.
Output impedance		About 5 $\Omega$ / 25 $\Omega$ / 100 $\Omega$ (depending on measurement range, etc.)
Max. drive current		About 200mArms

#### 3.4.2 Connection to DUT

Connect **ZM2371 / ZM2372** and DUT with 4-terminal (4-terminal-pair) as shown below to avoid the influence of contact resistance.

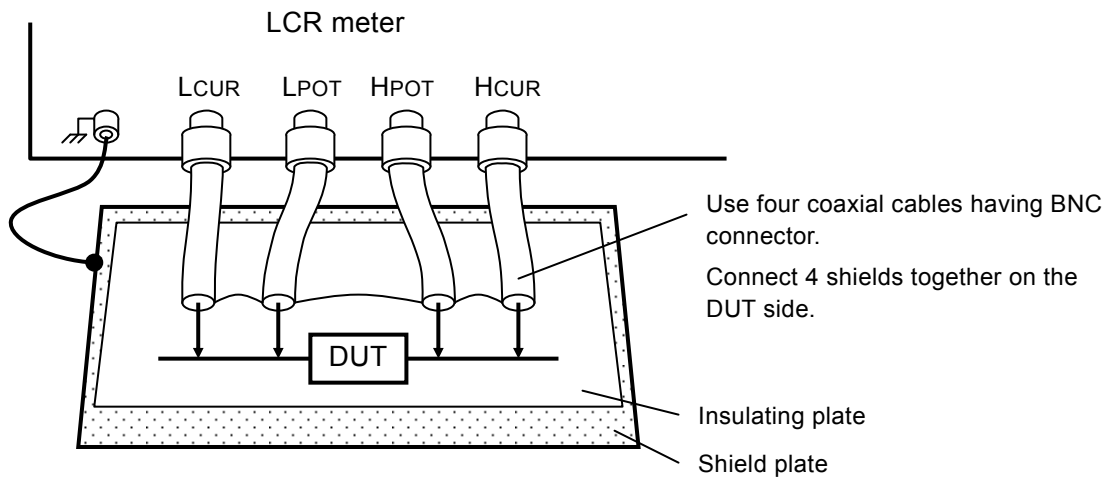

When the measured value is unstable due to a noise, lay a metallic plate connected to the outer conductor (shields) of measurement cables or the case under the DUT for shielding.

**Figure 3-4 Connection to DUT**

In the measurement of high impedance, shielding around the DUT can restrict variation of measured value. In a simplified method, place an insulating plate on the top surface of **ZM2371 / ZM2372**, and measure the DUT on it.

The **ZM2371 / ZM2372** cannot measure the grounded DUT. Both ends of DUT must be both insulated from the grounding.

When commercially available test fixture or test lead is used, refer to the instruction manual of these products. The product in which the shields of respective terminals are not connected cannot be used together with the **ZM2371 / ZM2372**.

### 3.4.3 Precautions on Connection

#### ■ Handling of shields

Connect the shields (outer conductor) of connection cables, 4 pieces together on the DUT side. The current that flows from H<sub>CUR</sub> terminal through DUT to the L<sub>CUR</sub> terminal returns to the H<sub>CUR</sub> terminal through the shield. Measurement will fail unless this return path is provided. To stabilize reference potential in the voltage detection part, connect the voltage cable shield and the current cable shield.

Do not connect the connection cable shields to the ground. If grounded, a noise will mix in due to electromagnetic coupling by a ground loop or common impedance coupling with other devices.

#### ■ Electromagnetic interference prevention and electromagnetic susceptibility improvement

In the cable connection with the DUT, put four coaxial cables together in the vicinity of measurement terminals of LCR meter, and attach the common mode choke. It can reduce high-frequency radiation field disturbance received from the periphery, or reversely disturbance given to the periphery.

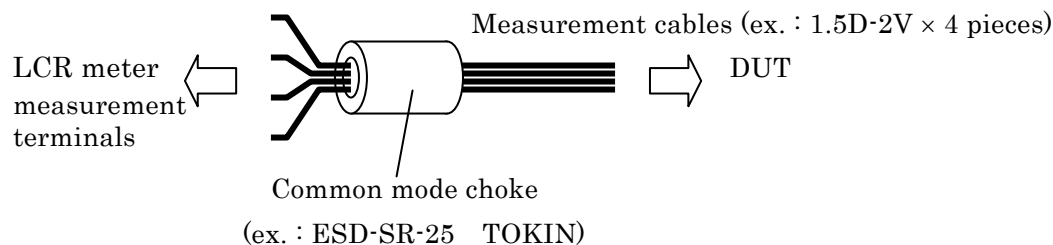

#### ■ Selection of cables

In the measurement of low impedance such as capacitors having large capacitance, a voltage drop of L<sub>CUR</sub> cable causes a common mode noise, increasing the measurement error. This error cannot be corrected by the cable length correction. In a narrow measurement range, the error can be reduced by the LOAD correction and it is therefore recommended to use thick and short current cables (particularly for L<sub>CUR</sub>) so as to reduce the resistance of cable inner conductor to 0.5Ω or less per cable. Note that the circuit (including probe resistance and contact resistance) between cables and DUT has similar influence.

In the measurement of high impedance such as capacitors having small capacitance, using long connection cables increases the error due to electrostatic capacitance of the cables. This error can be corrected by the cable length correction. However, correctable cables are coaxial cables of characteristic impedance 50Ω (capacitance: about 100pF/m) having the specified length. When the cables used are out of specification or when an error is large due to the DUT to earth capacitance, the error can be reduced by the LOAD correction only in a narrow measurement range.

Using the cables exceeding substantially the specified length makes the **ZM2371 / ZM2372** operation unstable due to the influence of resistance value or capacitance of cable inner conductor, causing the measurement to be failed. Also, if DUT to earth capacitance is large, the operation may become unstable.

It may not be always true depending on the resistance value of DUT or cables, but a total of capacitance of four connection cables and capacitance to earth of DUT should be reduced to 2000pF or less.

### ■ Cable routing and electromagnetic induction

Presence of noise sources such as motors or power transformers that generate large magnetic field near the device causes a noise to get mixed in due to electromagnetic induction. To avoid this, perform the wiring so that a large loop is not made.

If electromagnetic induction occurs between current cable and voltage cable, an error will increase in the low impedance measurement or an error will vary with the movement of cables. Twisting two cables each between current cable and current cable, and between voltage cable and voltage cable, or twisting four cables together so that the voltage cables are arranged diagonally and also the current cables are arranged diagonally as viewing the cross section can reduce an error due to electromagnetic induction between cables.

### ■ Noise mixing in due to electrostatic coupling

If inner conductor of  $L_{CUR}$  and  $L_{POT}$  cables are exposed, a noise will mix in due to electrostatic coupling with noise sources. Provide an electrostatic shield or keep peripheral potential constant.

Be sure to connect the **ZM2371 / ZM2372** case to the ground. Using 3-pole power cord, connect **ZM2371 / ZM2372** to the 3-pole power socket having a protective grounding contact, so that the device is connected to the ground. Unless grounded, not only a hazardous situation occurs but also the potential of case varies according to the power frequency or line noise, thus allowing a large noise to mix in.

### ■ Avoidance of 2-terminal connection

If  $L_{CUR}$  cable and  $L_{POT}$  cable are connected in the middle of cable, the measurement result includes the contact resistance with DUT (resistance value of two paralleled contact resistances). This is also true when  $H_{CUR}$  cable and  $H_{POT}$  cable are connected halfway. If the cables on H side or L side are connected halfway, even apparent four cables are equivalent to the 2-terminal connection. In the measurement of low impedance or measurement of small loss D (or equivalent series resistance ESR), when the contact resistance is not negligible, connect four connection cables independently to the DUT.

### ■ Influence of contact resistance

An error caused by the contact resistance with DUT can be restricted by 4-terminal connection, but since the input impedance of voltage measuring terminals is not infinite, there may be some influence. Particularly when the contact resistance exceeds  $10\Omega$ , prior evaluation should be made before use.



## 3.5 Basic Operations

### 3.5.1 Outline of Measurement Screen

During the measurement, the measured value and main settings are displayed on the LCD display (40 characters × 2 lines) of the front panel. Basic contents of display are as shown below.

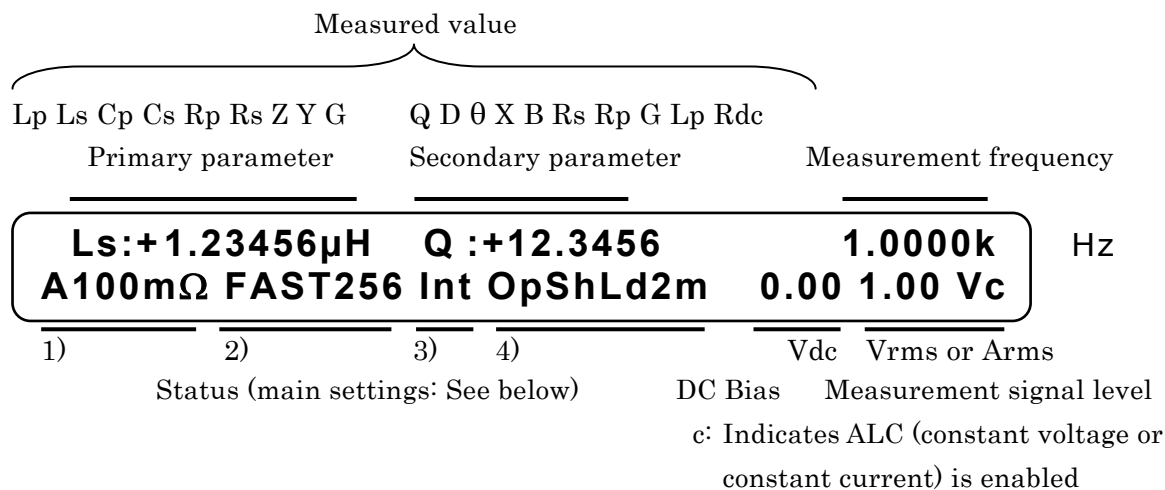

1) RANGE : Measurement range

{Auto | Hold} and impedance measurement range

2) SPEED/AVERAGE : Measurement speed and averaging

{RAP | FAST | MED | SLOW | VSLO} and averaging count

3) TRIG SOURCE

{Int | Man | Ext | Bus}

4) CORRECTION

Op OPEN (Op, Sh, Ld are displayed when enabled)

Sh SHORT

Ld LOAD

Xm Cable length {0m | 1m | 2m | 4m}

{ } indicates that either one of options delimited with | is displayed.

### 3.5.2 Basic Key Operations

#### ■ Primary function

Press each key on the front panel, and the function written on the key top will operate.

**TTT** key: Implies the key with “TTT” written on the key top.



#### ■ Secondary function

If the **SHIFT** key (blue) is pressed, the secondary function written with blue characters above the key becomes active. At this time, SHIFT is displayed at the lower right of character display. In this state, press any key, and the secondary function of that key will operate.

If the secondary function operates once or the **SHIFT** key is pressed again, the SHIFT state is cancelled.

**SHIFT** + **AAA** Indicates that after pressing the **SHIFT** key, the key with AAA (blue) written above the key is pressed.

**TTT** | **BBB** key Indicates the key with TTT written on the key top and BBB written above or under the key.

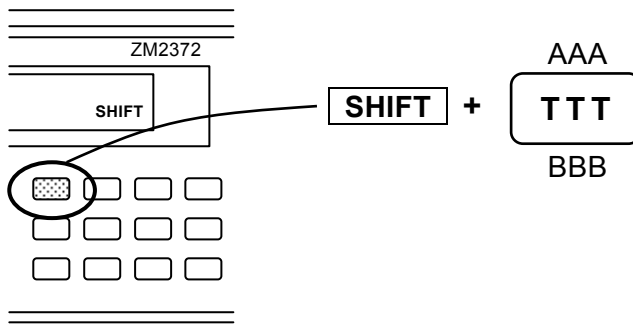

#### ■ Tertiary function

The tertiary function (BBB) written under the key operates according to the operation flow or situations at that time.

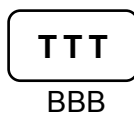

### ■ Operation of setting menu

Depending on the key operations, the setting menu will be displayed to select a function or set a numeric value.

**Function selection:** When options are displayed on the lower line of the setting menu, an option can be selected by pressing a numeric key associated with each option.

Options that cannot be accommodated in one line are displayed over multiple pages. The pages can be switched with **[BS]** | **[PREV]** key and **[EXP]** | **[NEXT]** key.

Even an option that exists on the page not displayed, it can be selected with the associated numeric key.

Parameter name and current settings

Parameter_name: Value1 (Value2)				
0)alt1	1)alt2	2)alt3	Comments	>NEXT

Options

Indicates that options exist on another page

**Numeric value input:** When the cursor is located at the parameter to which a numeric value can be entered, the comments such as a range of settable values are displayed on the lower line of the setting menu. The cursor is displayed by blinking the digit

The following key operations are possible.

- Numeric keys, decimal point key, sign key : Input a numeric value.
- **[EXP]** + [ x ] : Input exponential part (x = p, n,  $\mu$ , m, k, M) of a numeric value to enter the value (**[ENTR]** need not be pressed).  
For details  Input of exponential part. (Mentioned later)
- **[ENTR]** key : Enters the input value.
- **[BS]** key : Clears a value being input, one character at a time from the last.
- **[SHIFT]** + **[CE]** : Clear a value being input, all at once.

Upon clear of a value being input, the currently set value is displayed. For the menu that sets multiple parameters, the parameters to be set can be switched with **[BS]** | **[PREV]** key and **[EXP]** | **[NEXT]** key.

Parameter name and current setting

Parameter_name: Value1 (Value2)	
Range of value	Comments

Settable range

**Input of exponential part**

**EXP** + [ x ] Indicates that after **EXP** key is pressed, the key expressed as x on the right side is pressed.

If **EXP** key is pressed during input of a numeric value, EXP is displayed at the lower right of display, waiting for input of exponential part. In this state, press any key, so that exponential part x written on the right side of that key can be input.

Exponential part that can be input: p ( $10^{-12}$ ), n ( $10^{-9}$ ),  $\mu$  ( $10^{-6}$ ), m ( $10^{-3}$ ), k ( $10^3$ ), M ( $10^6$ ).

Input exponential part or press **EXP** key again, and the exponential part input waiting state is cancelled.

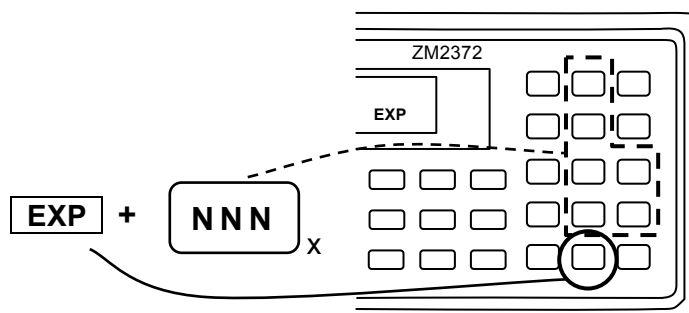

**EXIT operation** With the setting menu, if **ENTR** | **[EXIT]** key is pressed without setting or selecting a value, one-previous menu is returned. However, depending on the parameter, the setting menu is closed and the measurement screen comes back. There are some parameters that automatically returns to one-previous menu or measurement screen without executing the EXIT operation, after a value was set or selected.

**Reset of error message**

An error message may be displayed when, for instance, the input value exceeds the setting range.

The error message can be reset by pressing any key. After confirming the contents of an error, press the **ENTR** | **[EXIT]** key at the lower right for instance to reset the error message.

### 3.5.3 Simplified Operating Method When You Use Device for the First Time

This section describes the simplified operating method when you use the **ZM2371 / ZM2372** for the first time.

Do not connect the handler interface and remote control interface.

Perform operation through the procedure mentioned below:

- 1) Unlock the key lock
- 2) Initialize
- 3) Set measurement conditions
- 4) Connect and measure the DUT

With the factory default settings, unlocking of key lock and initialization can be omitted.

#### ■ Unlock the key lock

When the KEY LOCK lamp lights up, first press the **[SHIFT]** + **[KEY LOCK]** keys to unlock the key lock. In concrete terms, after pressing the **[SHIFT]** key, press the **[LOCAL]** | **[KEY LOCK]** key with KEY LOCK written above the key.

#### ■ Initialize

Press the **[SHIFT]** + **[INIT]** keys to display the initialize menu, and press the **[1]** key to return to the initial setting state.

When you use the **ZM2371 / ZM2372** that has already been set variously, performing the initialization makes later operations easy. The contents saved in the settings and correction value memories are not initialized by this operation.

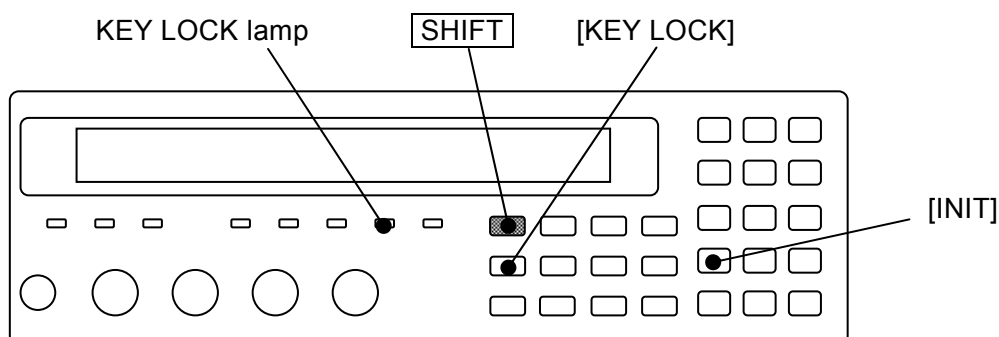

## ■ Selection of measurement parameters

### • Selection of primary parameter

Press the **[Pri]** key to display the primary parameter selection menu (see below), and select a primary parameter with a numeric key. Also, the measurement parameters (primary and secondary) can be selected automatically.

For details  “3.5.5.1 Selection of Primary Parameter”

<b>Primary parameter : C</b>	<b>Auto:OFF</b>	Current setting
<b>0)Auto OFF 1)ON 2)L 3)C 4)R 5)Z 6)Y 7)G</b>		Options

If either L, C, or R is selected, the equivalent circuit selection menu is displayed.

### • Selection of primary parameter equivalent circuit

For the L, C, and R, specify the equivalent circuit additionally.

Press the **[CKT]** key to display the equivalent circuit selection menu (see below), and select Parallel (suffix p) or Series (suffix s) with a numeric key. Automatic selection is also possible.

For details  “3.5.5.2 Setting the Equivalent Circuit”

<b>Equivalent CKT : Series</b>	<b>Auto:OFF</b>	Current setting
<b>0)Auto OFF 1)ON 2)Parallel 3)Series</b>		Options

### • Selection of secondary parameter

Press the **[Sec]** key to display the secondary parameter selection menu (see below), and select a secondary parameter with a numeric key. The options can be switched to those on the second page with the **[EXP]** | **[NEXT]** key.

For details  “3.5.5.3 Setting the Secondary Parameter”

<b>Secondary parameter : D</b>	Current setting
<b>0)Q 1)D 2)<math>\theta</math> 3)X 4)B 5)Rs &gt;NEXT</b>	Options (First page)
<b>6)Rp 7)G 8)Lp 9)Rdc &lt;PREV</b>	Options (Second page)

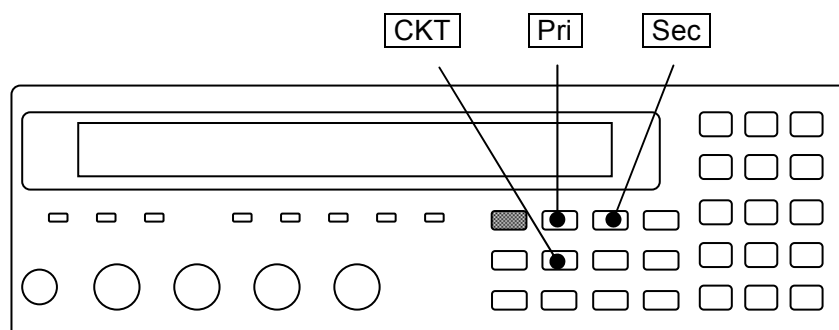

**■ Setting of measurement conditions****• Measurement frequency**

Press the **FREQ** key to display the measurement frequency setting menu, and select the frequency with a numeric key or set a numeric value.

**• Measurement signal level**

Press the **LEVEL** key to display the measurement signal level setting menu, and set the voltage.

**• Measurement speed**

Press the **SPEED** key to display the measurement speed setting menu, and select the measurement speed with a numeric key.

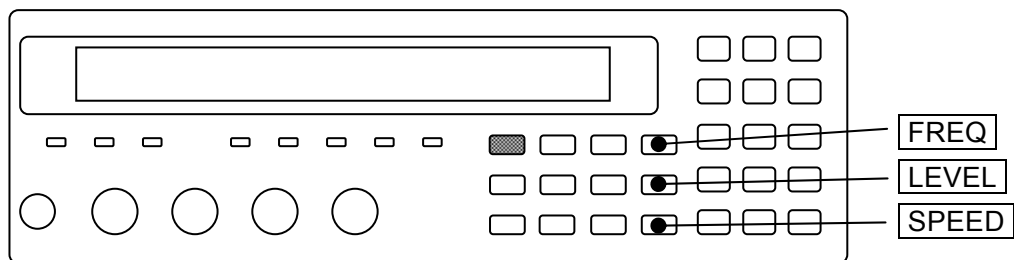

- **Trigger source**

Press the **[SHIFT]** + **[TRIG MODE]** keys to display the trigger setting menu (see below), and set the trigger source with a numeric key.

<b>TRIG SRC:Ext Delay=100.000s SRC Sync=ON</b>	Current setting
<b>0)Int 1)Man 2)Ext 3)Bus 4)Delay 5)S.Sync</b>	Options

Int	Internal. Automatic repetitive measurement (default)
Man	Manual. Press <b>[TRIG]</b> key on the front panel to trigger the measurement.
Ext	External. The trigger signal of handler interface is used to trigger the measurement.
Bus	Remote control

- **Measurement range**

The default setting is automatic selection.

Press the **[AUTO/HOLD]** key, so that Automatic selection (Auto) and Manual selection (Hold) can be switched.

Press the **[SHIFT]** + **[RANGE]** keys to display the measurement range setting menu (see below), and press a numeric key (**[0]** key or **[1]** key) to change the measurement range manually. The range is held (manual selection).

<b>RANGE : Manual 1k<math>\Omega</math> Rd : 25<math>\Omega</math>-</b>	Current setting
<b>0)DOWN 1)UP 100m<math>\Omega</math> to 1M<math>\Omega</math> 2)Rd-min</b>	Options

When a measurement range value is large, it is approximate the lower limit of measurement range, or when a value is small, it is approximate the upper limit of measurement range.

For details  **“Table 3-2 Measurement rang list”**

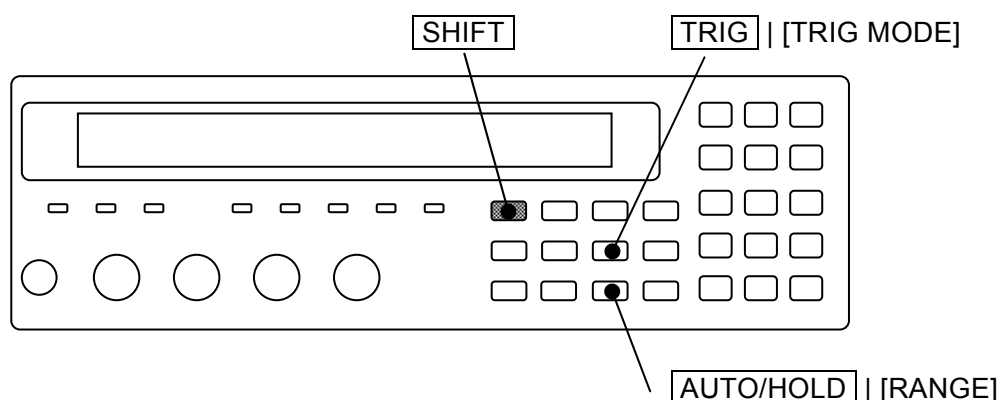

- **Connection of DUT and measurement**

- **Connection of DUT**

Referring to **“3.4 Connection of DUT”**, connect the LCR meter to the DUT.

- **Manual trigger**

Set the trigger source to “Manual”, and press the **[TRIG]** key, so that the trigger signal is applied and the measurement is executed once.



### 3.5.4 Initialization

There are two types of initialization as described below.

#### ■ Initialization of current settings

##### **SHIFT** + [ INIT ]

Press the **SHIFT** + [INIT] keys to display the initialize menu, and press the **1** key, so that currently used settings and correction values are reset to default values.

Upon initialization, the initialization completion message “Done” is displayed, and then the measurement screen comes back.

**Done**

The contents of settings and correction value memories are not initialized.

If the EXIT operation is performed without pressing the **1** key, the measurement screen comes back.

Only the settings cannot be initialized without initializing correction values. Save necessary correction values in the correction value memory.

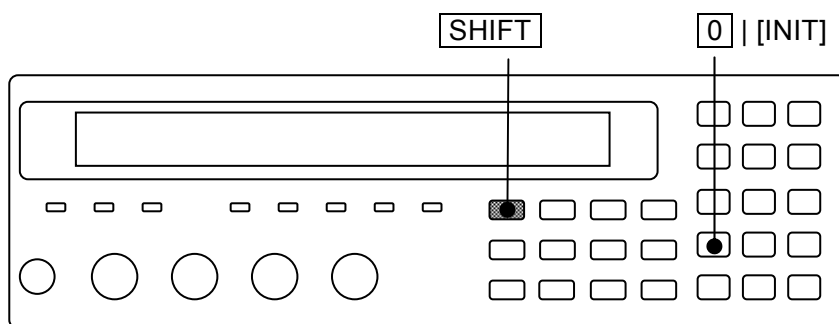

#### ■ Full initialization

To reset all settings except operation modes to the factory default values, perform full initialization. The contents of settings and correction value memories are also initialized.

For details  **“4.10 Initializing all Settings”**

### 3.5.5 Setting of Measurement Parameters

The **ZM2371 / ZM2372** can display two parameters (primary parameter and secondary parameter) at the same time.

In general, L, C, R values are different between series equivalent circuit and parallel equivalent circuit, and therefore select appropriate equivalent circuit according to the nature and circuits used of the DUT.

#### 3.5.5.1 Selection of Primary Parameters

**Pri**

Press the **Pri** key to display the primary parameter selection menu (see below), and select a primary parameter with a numeric key.

<u>Primary Parameter</u>	<u>Auto selection function</u>	
<b>Primary parameter : C</b>	<b>Auto:OFF</b>	Current setting
<b>0)Auto OFF 1)ON 2)L 3)C 4)R 5)Z 6)Y 7)G</b>		Options

- Auto OFF    Disables automatic selection of measurement parameters.
- ON            Enables automatic selection of measurement parameters.
- L            Inductance L<sub>p</sub> or L<sub>s</sub> (unit: Henry “H”)
- C            Capacitance C<sub>p</sub> or C<sub>s</sub> (unit: Farad “F”)
- R            Resistance R<sub>p</sub> or R<sub>s</sub> (unit: Ohm “Ω”)
- Z            Magnitude of impedance |Z| (unit: Ω)
- Y            Magnitude of admittance |Y| (unit: Siemens “S”)
- G            Conductance indicated with parallel equivalent circuit G<sub>p</sub> (unit: S)

If either L, C, or R is selected, the equivalent circuit selection menu is displayed.  
 If a parameter other than L, C, and R is selected or EXIT operation is performed, the measurement screen comes back.

If primary parameter is set to G, automatic selection of equivalent circuit is disabled and the parallel equivalent circuit is set.

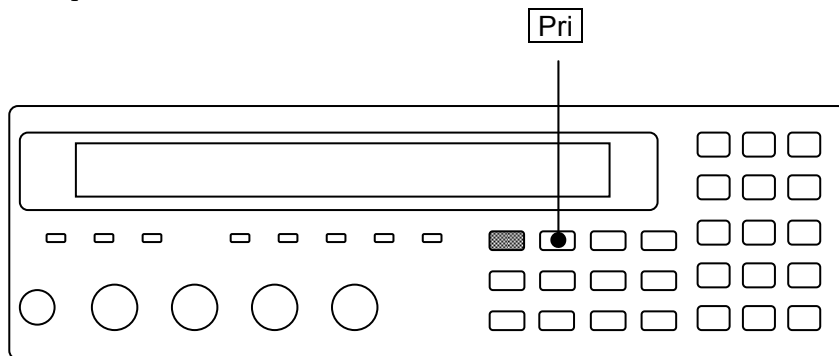

Each display range of primary parameters is as follows:

L	$\pm(0.000\text{nH to } 99.9999\text{GH})$
C	$\pm(0.00000\text{pF to } 999.999\text{kF})$
R	$\pm(0.000\text{m}\Omega \text{ to } 999.999\text{M}\Omega)$
Z	$0.000\text{m}\Omega \text{ to } 999.999\text{M}\Omega$
Y	$0.00\text{nS to } 9.99999\text{kS}$
G	$\pm(0.00\text{nS to } 9.99999\text{kS})$

The display range is limited by the measurement range.

The display range of L and C varies depending on the frequency.

### ■ Automatic selection of measurement parameters

Automatic selection rule of measurement parameters is as follows:

Phase angle $\theta$ of impedance	Primary parameters	Secondary parameters
+30 to +120°	L	Q
-30 to +30°	R	Q
-120 to -30°	C	D
Others	Z	$\theta$

When a measurement parameter is automatically selected, the primary parameter, secondary parameter, and equivalent circuit are automatically selected based on the phase angle or magnitude of impedance. When the primary parameter is other than L, C, R, and Z, if a measurement parameter is automatically selected, immediately after that, Z is selected as a primary parameter.

If a specific primary parameter, secondary parameter, or equivalent circuit is set, or if automatic selection of equivalent circuit is disabled, automatic selection of measurement parameter is disabled and the primary parameter, secondary parameter, and equivalent circuit at that time are set.

### ■ Negative display of L, C, R

From the relation of reactance  $X=\omega L=-1/(\omega C)$  and susceptance  $B=\omega C=-1/(\omega L)$ , (here,  $\omega=2\times\pi\times\text{frequency}$ ), when  $\theta > 0$  ( $X > 0$ ), C is smaller than 0 ( $C < 0$ ). Also, when  $\theta < 0$  ( $B > 0$ ), L is smaller than 0 ( $L < 0$ ).

From the relation of  $R=|Z|\cos\theta$ , if  $\theta > +90^\circ$  or  $\theta < -90^\circ$  due to a measurement error, R is smaller than 0 ( $R < 0$ ).

### ■ Parameters that can be selected by remote control only

By remote control, the followings can be specified, in addition to L, C, R, Z, Y, and G.

For details  Chapter 5 :CALCulate1: FORMat command

Lp, Ls	Inductance with equivalent circuit specified to parallel or series
Cp, Cs	Capacitance with equivalent circuit specified to parallel or series
Rp, Rs	Resistance with equivalent circuit specified to parallel or series
REAL	Real part of immittance (Rs or Gp. Either one is displayed as measured value)
MLIN	Magnitude of immittance ( $ Z $ or $ Y $ . Either one is displayed as measured value)

Impittance is generic name of impedance and admittance.

If these are selected, automatic selection of measurement parameter and equivalent circuit is disabled.

**3.5.5.2 Setting of Equivalent Circuit**

**CKT**

Press the **CKT** key to display the equivalent circuit selection menu (see below), and select parallel (suffix p) or series (suffix s) with a numeric key.

Equivalent circuit	Auto selection function	
<b>Equivalent CKT : Series      Auto:OFF</b> <b>0)Auto OFF    1)ON    2)Parallel    3)Series</b>		Current setting
		Options

- Auto OFF    Disables automatic selection of equivalent circuit
- ON            Enables automatic selection of equivalent circuit
- Parallel     Parallel equivalent circuit (automatic selection is disabled)
- Series        Series equivalent circuit (automatic selection is disabled)

If an equivalent circuit is set or EXIT operation is performed, the measurement screen comes back.

**AUTO CKT lamp**

The AUTO CKT lamp lights up when automatic selection of equivalent circuit is enabled.

When the primary parameter is L, C, R, Z, or Y, the equivalent circuit can be specified or its automatic selection function can be used. However, |Z| and |Y| values do not depend on the equivalent circuit.

If automatic selection of equivalent circuit is enabled, the equivalent circuit is automatically selected based on the automatic selection rule listed below when the primary parameter is L, C, or R.

Automatic selection rule			Equivalent circuit
L	C	R	
$ Z  \leq 1k\Omega$	$ Z  \leq 1k\Omega$	$\theta \geq 0$	Series
$ Z  > 1k\Omega$	$ Z  > 1k\Omega$	$\theta < 0$	Parallel

If the primary parameter is set to other than L, C, and R, automatic selection of equivalent circuit is as follows.

Primary parameter	[:SENSE]:FUNCTION[:ON]	Equivalent circuit	Automatic selection
Z, Y	(Don't care)	Last value retained	Last value retained
Rs, Cs, Ls	(Don't care)	Series	Disable
Rp, Cp, Lp, G	(Don't care)	Parallel	Disable
REAL, MLIN	FIMPedance	Series	Disable
	FADMittance	Parallel	Disable

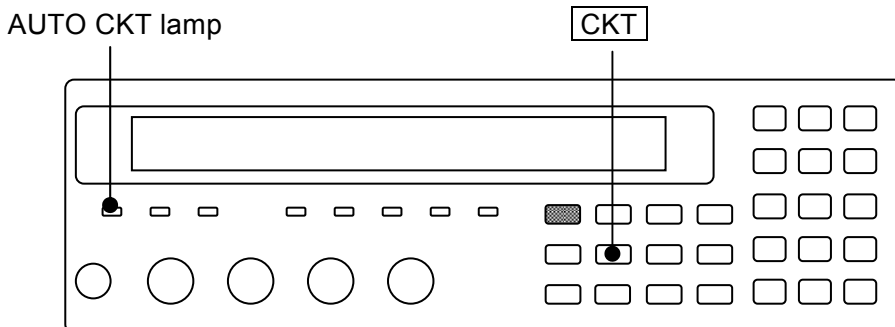

## 3.5.5.3 Setting of Secondary Parameters

**Sec**

Press the **Sec** key to display the secondary parameter selection menu (see below), and select a secondary parameter with a numeric key.

<b>Secondary parameter : D</b>	Current setting
<b>0)Q 1)D 2)θ 3)X 4)B 5)Rs &gt;NEXT</b>	Options (first page)
<b>6)Rp 7)G 8)Lp 9)Rdc &lt;PREV</b>	Options (second page)

Q	Quality factor (= 1/D)
D	Dissipation factor (= $\tan\delta$ )
$\theta$	Phase angle of impedance (unit: degree)
X	Reactance $X_s$ expressed with series equivalent circuit (unit: $\Omega$ )
B	Susceptance $B_p$ expressed with parallel equivalent circuit (unit: S)
$R_s$	Resistance $R_s$ expressed with series equivalent circuit (unit: $\Omega$ )
$R_p$	Resistance $R_p$ expressed with parallel equivalent circuit (unit: $\Omega$ )
G	Conductance $G_p$ expressed with parallel equivalent circuit (unit: S)
$L_p$	Inductance $L_p$ expressed with parallel equivalent circuit (unit: H)
$R_{dc}$	Direct-current resistance $R_{dc}$ (unit: $\Omega$ )

Any secondary parameters can be selected regardless of a setting of equivalent circuit.

If a setting is made or the EXIT operation is performed, the measurement screen comes back.

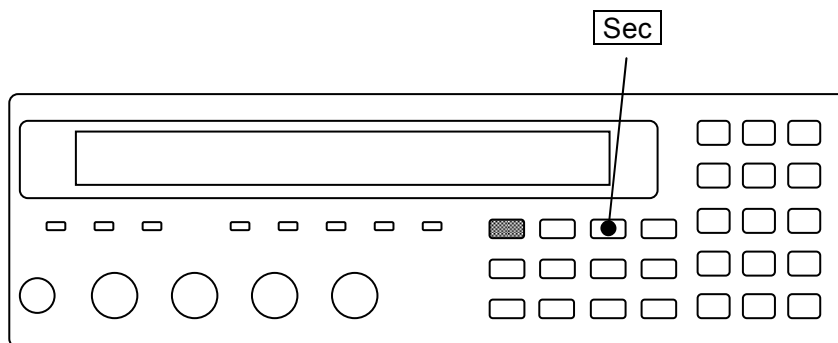

A display range of each secondary parameter is as follows:

Q, D	$\pm(0.00000 \text{ to } 99999.9)$
$\theta$	$\pm(0.000^\circ \text{ to } 180.000^\circ)$
$R_s, R_p, X, R_{dc}$	$\pm(0.000\text{m}\Omega \text{ to } 999.999\text{M}\Omega)$
G, B	$\pm(0.00\text{nS} \text{ to } 9.99999\text{kS})$
$L_p$	$\pm(0.000\text{nH} \text{ to } 99.9999\text{GH})$

The display range is limited by the measurement range.

**■ Negative display of Q, D, R, G**

When the phase angle of impedance  $\theta > +90^\circ$  or  $\theta < -90^\circ$  due to a measurement error, the loss angle seems to be a negative value, and thus the Q, D, Rs (ESR), Rp, and G become negative values. Also, Rdc may become a negative value due to a measurement error of voltage or current.

**■ Parameters that can be selected by remote control only**

The following options can be selected by remote control only. They cannot be selected from the panel.

For details  Chapter 5 :CALCulate2: FORMat command

IMAG      Imaginary part of immittance (X or B)

REAL      Real part of immittance (either of Rs, G, or Rdc)

Impittance is generic name of impedance and admittance.

### 3.5.6 Setting of Basic Measurement Conditions

#### 3.5.6.1 Measurement Frequency

The measurement frequency is displayed at the upper right of measurement screen.

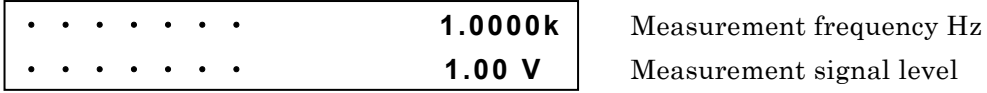

#### **FREQ**

Press the **FREQ** key to display the measurement frequency setting menu.



- 120            120Hz
- 1k             1kHz
- 10k            10kHz
- 100k           100kHz
- Entry         Displays the measurement frequency input menu to input a numeric value.

If a setting is made or the EXIT operation is performed, the measurement screen comes back.

Entry: The measurement frequency input menu is as follows.



The setting resolution is 5 digits (1mHz when < 10Hz).

If a setting is made or the EXIT operation is performed, one-previous menu comes back.

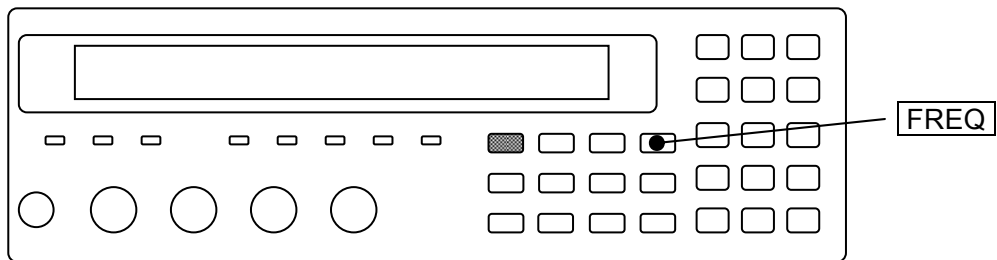

**3.5.6.2 Measurement Signal Level**

The measurement signal level is displayed at the lower right of measurement screen.

• • • • • • •	<b>1.0000k</b>	Measurement frequency Hz
• • • • • • •	<b>1.00 V</b>	Measurement signal level Vrms

**LEVEL**

Press the **LEVEL** key to display the measurement signal level setting menu.

<b>Level: 1.00 V</b>	Current setting
<b>0.010V to 5.00V</b>	Range of settable values

The setting resolution is 3 digits (1mV when < 100mV).  
 Though the value is a root-mean-square value (unit: Vrms), it is simply displayed as V.

If a setting is made or the EXIT operation is performed, the measurement screen comes back.

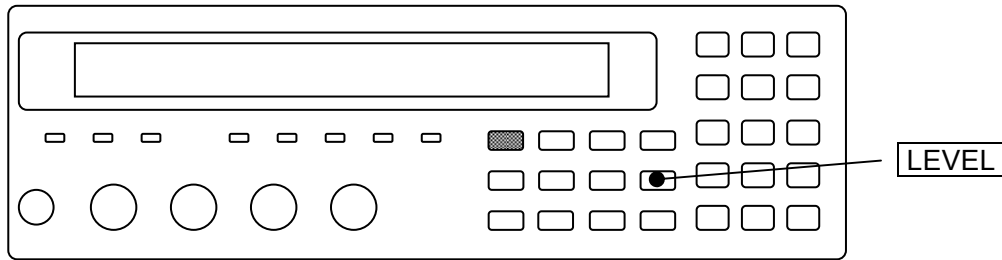

For the direct-current resistance Rdc, the voltage and current are measured with two measurement signals of about +1.4V and -1.4V, and Rdc is obtained from a difference of them, regardless of a setting of measurement signal level.



■ **ALC**

Enable the ALC function when the DUT is to be driven with constant voltage or constant current.

- ALC : Automatic Level Control
- CV : Constant Voltage
- CC : Constant Current

Set or check the voltage or current value in advance when specifying the CV or CC. Otherwise, a signal of unexpected level may be given to the DUT.

When ALC function is enabled, “c” is displayed following the measurement signal level.

. . . . .	<b>1.0000k</b>	Measurement frequency Hz
. . . . .	<b>1.00 Vc</b>	Measurement voltage level (Constant voltage Vrms)
. . . . .	<b>1.00mA<sub>c</sub></b>	Measurement current level (Constant current Vrms)

**SHIFT** + **[ALC]**

Press the **SHIFT** + **[ALC]** keys to display the ALC setting menu.

<b>ALC:OFF</b>	Current setting
<b>0)OFF 1)CV 2)CC 3)Current</b>	Options

- OFF Disables the ALC function (CV and CC).
- CV Enables the constant voltage function.  
(Voltage ↻ Measurement signal setting menu)
- CC Enables the constant current function. (Current ↻ Current setting menu)  
If either CV or CC is enabled, the other is disabled.
- Current Displays the current setting menu.

If a setting is made or the EXIT operation is performed, the measurement screen comes back.

Current: The current setting menu is as follows.

<b>Current: 1.00mA</b>	Current setting
<b>0.0010mA to 200mA</b>	Range of settable values

The setting resolution is 3 digits (0.1μA when < 10μA).

If a setting is made or the EXIT operation is performed, one-previous menu comes back.

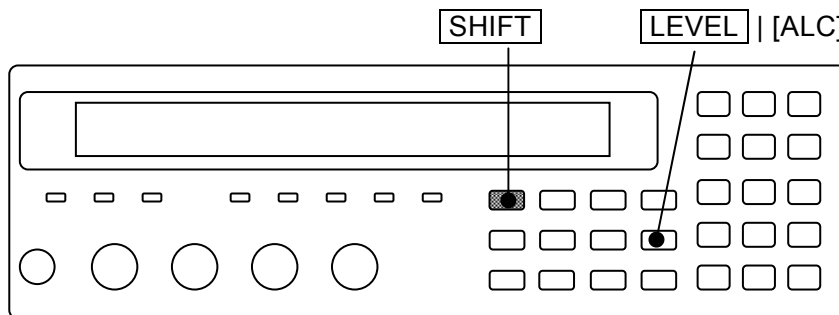

When the ALC function (CV or CC) is enabled, the LCR meter repeats the measurement while adjusting the measurement signal level until the following values are obtained.

CV: Voltage monitored value is the set value  $\pm 1\%$  of set value.

CC: Current monitored value is the set value  $\pm (1\%$  of set value + 0.02% of max. drive / detection current in measurement range)

Accordingly, the measurement will take time.

When the specified voltage or current cannot be obtained even though the adjustment of measurement signal level is repeated, an error occurs and the measured value becomes ALC Err.

When the measurement range is set to “auto selection”, first the measurement range is adjusted, and then the measurement signal level in that measurement range is adjusted. In that measurement range, the measurement signal level is changed in a range of 10mVrms to 5Vrms to adjust to the specified voltage or current.

---

**⚠ CAUTION**

---

**With the constant voltage function enabled, if the DUT is removed after small impedance was measured, the maximum 5Vrms signal may be output.**

**With the constant current function enabled, if the measurement terminals are opened, the maximum 5Vrms signal may be output.**

---

Automatic adjustment of voltage or current by the ALC is restricted as follows:

- 1) ALC function may fail if the voltage-current characteristics of DUT are extremely nonlinear.
- 2) The output impedance does not become  $5\Omega$  even if the minimum output impedance is set to  $5\Omega$  when the ALC function is enabled. The output impedance will become  $100\Omega$  or  $25\Omega$  following the measurement range, same as when the minimum output impedance is set to  $25\Omega$ .
- 3) Due to the characteristic variations of LCR meter, the voltage or current may not be adjusted to settable maximum voltage or maximum current.

**3.5.6.3 Measurement Range**

Set the measurement range according to the impedance of DUT.

Current measurement range setting is displayed at the lower left of measurement screen.



- A Auto: Automatic selection of measurement range
- H Hold: Measurement range is held for manual selection
- 100Ω Measurement range (100mΩ to 1MΩ)

**Table 3–2 Measurement range list**

Measurement range	Recommended range	Measureable range	Remarks
1MΩ	1MΩ to 11MΩ	900kΩ to	frequency ≤ 20kHz (*1)
100kΩ	100kΩ to 1.1MΩ	90kΩ to	—
10kΩ	10kΩ to 110kΩ	9kΩ to	—
1kΩ	1kΩ to 11kΩ	900Ω to	—
100Ω	9Ω to 1.1kΩ	Not limited	—
10Ω	0.9Ω to 10Ω	to 11Ω	Output impedance 100Ω/5Ω
1Ω	90mΩ to 1.0Ω	to 1.1Ω	Output impedance 25Ω/5Ω
100mΩ	9mΩ to 100mΩ	to 110mΩ	Output impedance 25Ω/5Ω

Recommended range: Recommended operating range for high accuracy measurement. If out of the recommended range extremely, the measured value or data output may be overflow.

Measureable range: Approximate range in which the measurement is possible. The measurement may be possible even outside the range given above depending on the measurement conditions, or the measurement may not be possible even within the range given above due to incoming noise

\*1 When frequency > 20kHz, the recommended range and measureable range are same as 100kΩ range even if 1MΩ range is specified.

**Table 3–3 Max. current, max. voltage and output impedance in each measurement range**

Measurement range	Max. drive / detection current	Max. voltage	Output impedance Rd
1MΩ	5μArms	5Vrms	100Ω
100kΩ	50μArms	5Vrms	100Ω
10kΩ	500μArms	5Vrms	100Ω
1kΩ	5mArms	5Vrms	100Ω
100Ω	50mArms	5Vrms	100Ω
10Ω	200mArms	5Vrms (1Vrms)	100Ω (5Ω)
1Ω	200mArms	5Vrms (1Vrms)	25Ω (5Ω)
100mΩ	200mArms	5Vrms (1Vrms)	25Ω (5Ω)

The values in ( ) are when the minimum output impedance is 5Ω, and the conditions for 5Ω are fulfilled. Allowable current peak value (instantaneous value) including DC bias current is about 1.4 times the current value given in table (root-mean-square value).

■ Automatic selection or hold of measurement range

**AUTO / HOLD**

Press the **AUTO/HOLD** key, and the measurement range is switched between automatic selection (AUTO) and hold (HOLD).

When the measurement range is held, it can be selected manually. When holding the measurement range, select a measurement range within the recommended range if possible, considering the variations of DUT.

For the DUT having large variations or strong nonlinearity, automatic selection may fail. Also, in the measurement of large capacitance or inductance, the settling of signal will take time. Several measurements may be required until correct measurement range is set in automatic selection and the measured value becomes stable.

■ Manual selection of measurement range

**SHIFT + [ RANGE ]**

Press the **SHIFT** + **[RANGE]** keys to display the measurement range setting menu.

Auto / Manual	Current range	Min. output impedance	
<b>RANGE : Manual</b>	<b>1k<math>\Omega</math></b>	<b>Rd : 25<math>\Omega</math>-</b>	Current setting Options
<b>0)DOWN 1)UP</b>	<b>100m<math>\Omega</math> to 1M<math>\Omega</math></b>	<b>2)Rd-min</b>	

Selectable operations      Selectable range

- Auto            Displayed when the measurement range is automatically selected.
- Manual        Displayed when the measurement range is manually selected (hold).
- DOWN         Switches the measurement range to a range having lower impedance by one.
- UP             Switches the measurement range to a range having higher impedance by one.
- Rd-min        Displays the minimum output impedance setting menu of drive signal source.

Change the measurement range with a numeric key, one step at a time. If DOWN or UP is operated, the measurement range is held (manual selection). Note that the measurement range of impedance should be lowered when measuring larger capacitance C or admittance |Y|.

Perform the EXIT operation to return to the measurement screen.

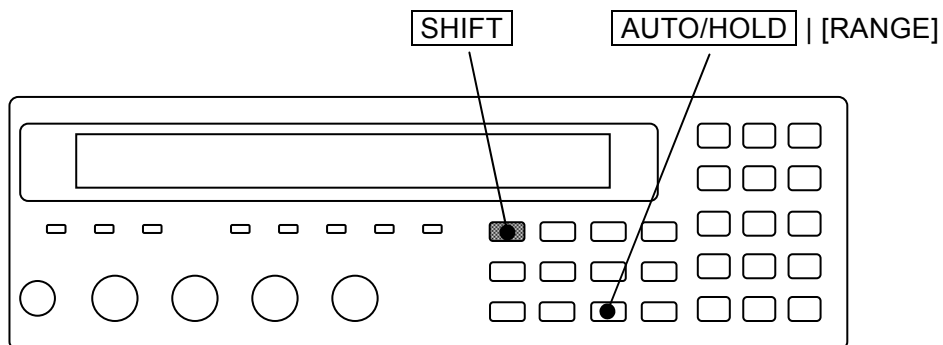

Rd-min: The minimum output impedance setting menu is as follows.

<b>R-drive min: 25Ω</b> <b>0)5Ω 1)25Ω</b>
--

Current setting

Options

5Ω Sets the minimum output impedance to 5Ω.

25Ω Sets the minimum output impedance to 25Ω (initial value).

If a setting is made or the EXIT operation is performed, one-previous menu comes back.

If 25Ω is selected, the output impedance of drive source becomes 100Ω (measurement range  $\geq 10\Omega$ ) or 25Ω (measurement range  $\leq 1\Omega$ ) according to the measurement range.

If 5Ω is selected, the output impedance of drive source becomes 5Ω, provided that the following conditions are all fulfilled. If not fulfilled, it becomes 100Ω or 25Ω according to the measurement range.

Measurement range  $\leq 10\Omega$

Measurement signal level  $\leq 1V$

ALC is disabled

DC bias is OFF

DC resistance is not measured

For example, when the capacitors (impedance  $< 10\Omega$ ) having large capacitance exceeding 150μF at 120Hz are measured, the signal settling time can be reduced if the output impedance is set to 5Ω.

When setting the output impedance to 5Ω, beware of the following points:

- If the output impedance is lowered with the measurement signal level maintained, the voltage applied to the DUT will increase. Reduce the measurement signal level in advance when measuring the DUT weak to the reverse voltage or overvoltage.
- Residual charge protection level lowers.  
Provide an external protection device as necessary.

#### ■ When a number of DUTs are measured

Hold the measurement range when measuring a number of DUTs having almost same value. In a low impedance range, a mechanical relay is used to switch the range. Though the range switching time in automatic selection is long, taking the relay lifetime into consideration, the wear of relay and increase of measurement time can be avoided by holding the measurement range.

#### ■ Measurement range of DC (direct-current) resistance

If DC resistance is selected as a secondary parameter, the measurement range of DC resistance is displayed in the measurement range setting menu. The DC resistance measurement range is independent from the AC impedance measurement range, and normally it is automatically selected. In the remote control, it can be held to specific range. To return to automatic selection by the panel operation, initialize it with the initialize menu.

DC resistance measurement range

<b>RANGE: Manual 100kΩ</b>	<b>DC100mΩ</b>	<b>Rd: 25Ω-</b>
----------------------------	----------------	-----------------

**3.5.6.4 Trigger**

The **ZM2371 / ZM2372** receive a trigger signal to start the measurement.

With the trigger setting menu, set the trigger source and measurement sequence.

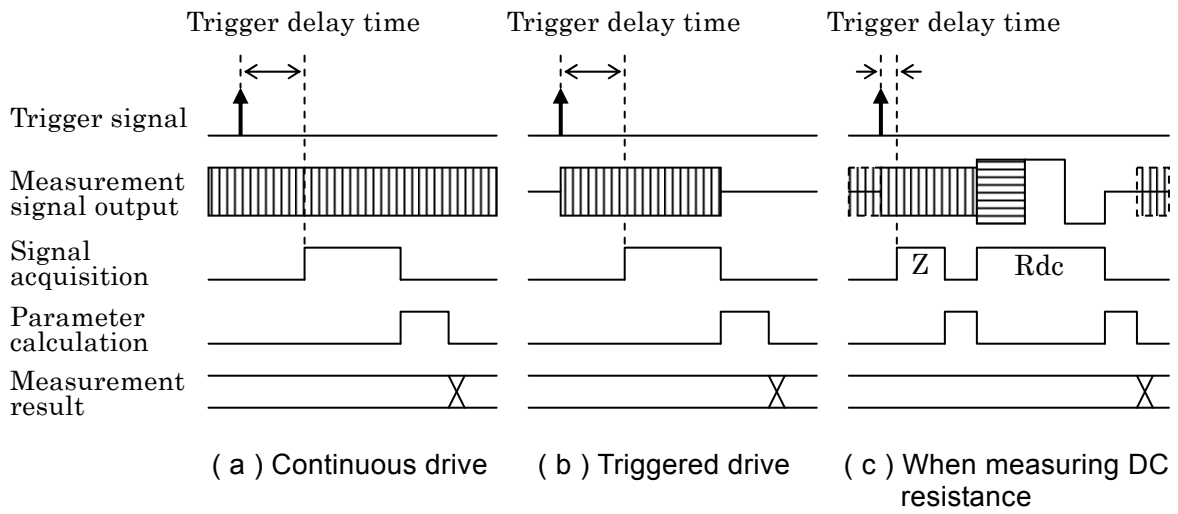

**Figure 3-5 Measurement sequence**

■ Selection of trigger source

**SHIFT** + [ TRIG MODE ]

Press the **SHIFT** + [TRIG MODE] keys to display the trigger setting menu.

Trigger source	Trigger delay	Triggered drive	
<b>TRIG SRC:Ext Delay=100.000s SRC Sync=ON</b>			Current setting
<b>0)Int 1)Man 2)Ext 3)Bus 4)Delay 5)S.Sync</b>			Options

- Int Internal trigger. Upon completion of measurement, a trigger is applied automatically and measurement is executed continuously. Other trigger signals are ignored.
  - Man Manual trigger. Press the **TRIG** key on the front panel to apply a trigger signal.
  - Ext External trigger  
A trigger is applied with \*TRIG signal through the handler interface.
  - Bus A trigger is applied by the remote control.  
\*Refer to the description of \*TRG and GET.
  - Delay Displays the trigger delay setting menu.
  - S.Sync Displays the triggered drive setting menu.
- } Trigger source

Select a trigger source or performe the EXIT operation to return to the measurement screen.

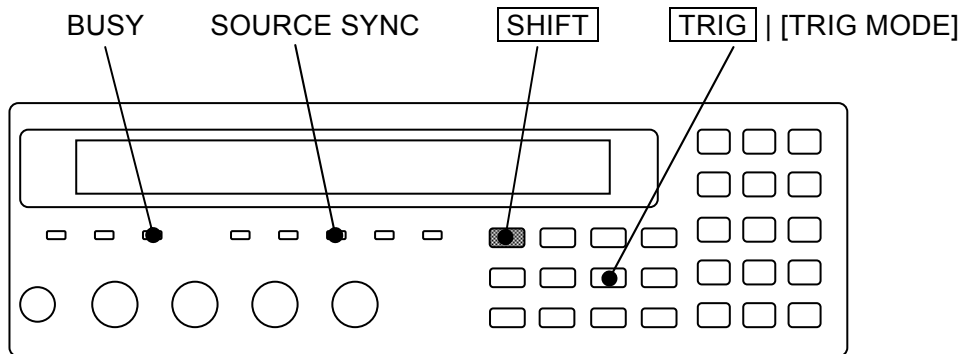

Current trigger source is displayed on the second line of measurement screen (in case of status display).

```
A100Ω FAST256 Int OpShLd1m . . . . .
TRIG SOURCE
```

Trigger source: Int / Man / Ext / Bus

■ Applying a trigger (measurement start)

**TRIG**

When the trigger source is Man (manual) and the measurement has not been executed, if the **TRIG** key is pressed, the measurement starts and it is executed only once. One-time measurement will take time when the frequency is lower than 1Hz, or the number of averaging count is large. Note that the last measured value is displayed during the measurement.

**BUSY lamp**

During measurement, the BUSY lamp lights up or blinks.

### ■ Trigger delay time: Trigger delay setting menu

The trigger delay time is the time from trigger up to signal acquisition start. The signal settling time varies depending on the nature of DUT or required accuracy. For the trigger delay time, set long time to the extent that the measured value does not vary even if the trigger delay time is changed a little.

Press the **[SHIFT]** + **[TRIG MODE]** keys to display the trigger setting menu, and select Delay with a numeric key and the trigger delay setting menu (see below) will be displayed.

<b>Trigger Delay : 0.456s</b> <b>0.000 to 999.999s</b>
---

Current setting

Range of settable values

Input a numeric value to set the trigger delay time. The setting resolution is 1ms.

If a setting is made or the EXIT operation is performed, one-previous menu comes back.

For high permittivity type capacitors having hysteresis characteristics or inductors having a core, it is recommended to acquire the signal after at least one period of signal elapsed (1ms at 1kHz, or 8ms at 120Hz) since the measurement signal was applied to the DUT. It may take long time for settling if dielectric absorption of DUT is large.

When the DUT does not have hysteresis or dielectric absorption, the settling time of signal is determined by the following two factors:

- 1) Time constant determined by **ZM2371 / ZM2372** output impedance or maximum drive current and capacitance of DUT
- 2) **ZM2371 / ZM2372** internal settling time

The **ZM2371 / ZM2372** output impedance and maximum drive current depend on the measurement range.

For details  **“3.5.6.3 Measurement Range”**

If the DUT is pure capacitance C or inductor L, the signal settles at the time constant  $C \times R_d$  or  $L/R_d$  where the **ZM2371 / ZM2372** output impedance is  $R_d$ . Make allowance for the settling time of 5 to 7 times the time constant. The settling time will vary if the current is limited.

The measurement will be incorrect if the trigger delay time is set to zero when the triggered drive is enabled. When the triggered drive is enabled, it will take time for the drive signal to settle in the **ZM2371 / ZM2372**. Also, the settling time is required when the frequency or signal level is changed.

Approximate settling time in the measurement of large capacitance can be obtained from the measurement frequency, DUT capacitance C (F), and output impedance  $R_d$  ( $\Omega$ ).

Measurement frequency 120Hz      Settling time =  $4\text{ms} + 6 \times R_d \times C$

Measurement frequency 1kHz      Settling time =  $1\text{ms} + 6 \times R_d \times C$

Setting example of trigger delay time (in both cases,  $R_d=100\Omega$ )

Measurement frequency 120Hz, DUT 220 $\mu$ F      Trigger delay time 142ms (about 17 periods of signal)

Measurement frequency 1kHz, DUT 10 $\mu$ F      Trigger delay time 7ms

The settling time by CR time constant can be reduced if the output impedance  $R_d = 5\Omega$ .



### ■ Drive only at measurement: Triggered drive setting menu

With the measurement signal output, connecting or disconnecting the low impedance DUT (particularly large capacitance) or inductor may damage the measurement contact.

Since the triggered drive signal drives the DUT only a period of time when **ZM2371 / ZM2372** is connected with the DUT, the damage to the contact caused by connecting or disconnecting the DUT can be reduced.

Also, when two or more devices are installed closely, if the measurement timing is shifted so that the drive signal does not overlap, the disturbance from other **ZM2371 / ZM2372** can be reduced.

Press the **[SHIFT]** + **[TRIG MODE]** keys to display the trigger setting menu, and select S.Sync with a numeric key, and the triggered drive setting menu (see below) will be displayed.

**Source Sync:ON**

Current setting

**0)OFF 1)ON**

Options

**OFF** Disables triggered drive.

Outputs measurement signal at all times.

**ON** Enables triggered drive.

Drives the DUT in synchronization with the trigger only when the instrument is connected with DUT.

If a setting is made or the EXIT operation is performed, one-previous menu comes back.

When the triggered drive is enabled, the DC bias is automatically set to OFF.

### SOURCE SYNC lamp

The SOURCE SYNC lamp lights up when the triggered drive is enabled.

3.5.6.5 Measurement Speed

**SPEED**

Press the **SPEED** key to display the measurement speed setting menu.

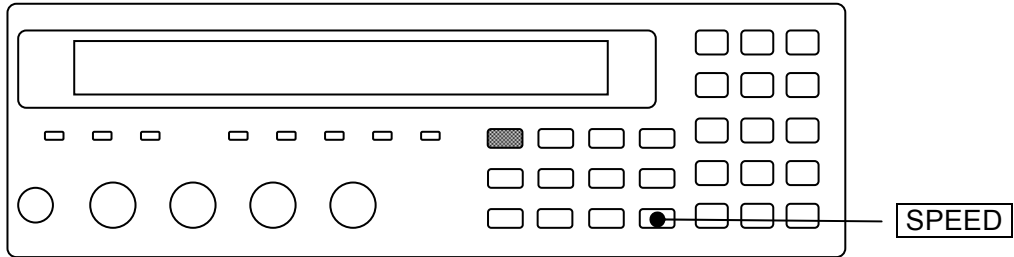

**Measuring Speed : FAST**  
**0)RAPID 1)FAST 2)MED 3)SLOW 4)VerySLOW**

Current setting  
 Range of settable values

If a setting is made or the EXIT operation is performed, one-previous menu comes back.

Current measurement speed is displayed on the second line of measurement screen.

A100Ω **FAST**256 Int OpShLd1m . . . . .

SPEED/AVERAGE

Measurement speed: RAPid / FAST / MEDium / SLOW / VerySLOW  
 (Lower-case letters are not displayed)

**Table 3-4 Example of measurement time (typical values)**

Measurement frequency	Measurement speed				
	RAP	FAST	MED	SLOW	VSLO
(DC)	148ms	148ms	148ms	215ms	613ms
120Hz	10ms (1 cycle)	10ms (1 cycle)	26ms (3 cycles)	126ms (15 cycles)	501ms (60 cycles)
1kHz	2ms (1 cycle)	5ms (4 cycles)	25ms (24 cycles)	121ms (120 cycles)	501ms (500 cycles)
10kHz	3ms	5ms	25ms	122ms	502ms
100kHz	3ms	5ms	25ms	122ms	502ms

Conditions: Measurement range hold, Trigger delay time = 0, Averaging count = 1  
 The measurement time of direct current (DC) is the time added when DC resistance is measured.

The measurement time at other frequencies is the time from input of TRIG signal to output of EOM signal through the handler interface when DC resistance is not measured.

The values in ( ) at 120Hz and 1kHz express the signal acquisition time with the cycles of the signal.

The signal acquisition time is obtained by subtracting the calculation time of about 1ms from the time given in table.

However, the signal acquisition time of direct-current resistance Rdc is obtained by subtracting about 83ms from the time given in table.

For details of signal acquisition time **"Figure 3-6 Signal acquisition time"**

After the signal acquisition, the DUT can be replaced.

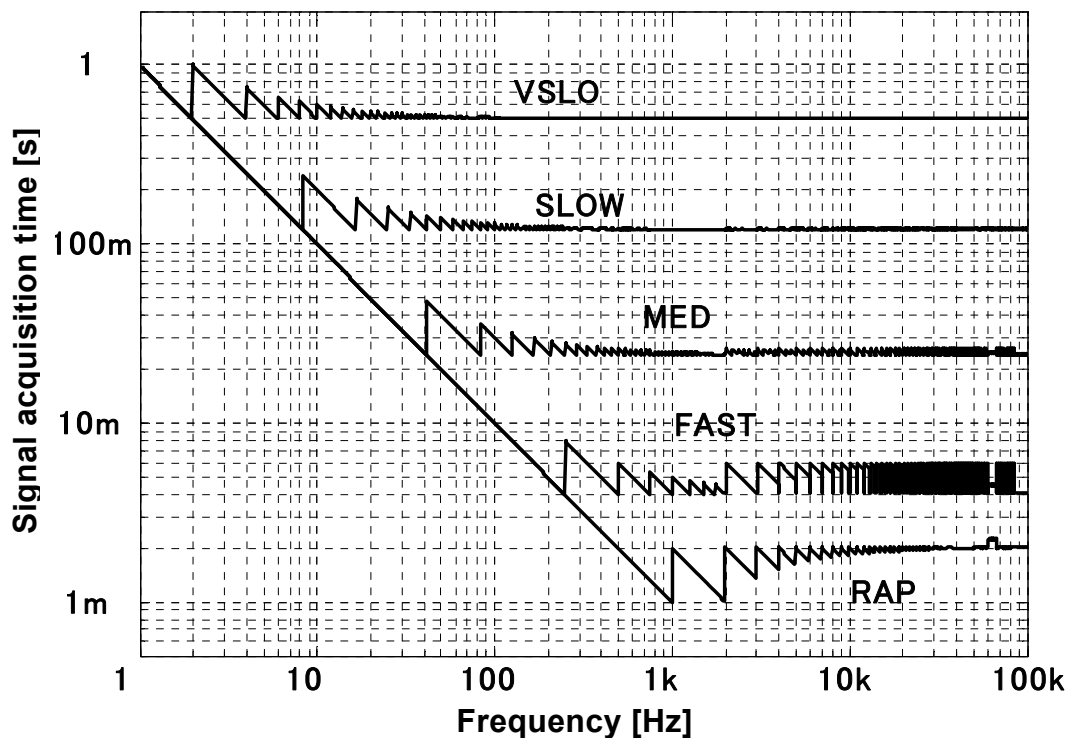

The signal acquisition time at frequency below 1Hz is about one cycle of the signal.

**Figure 3-6 Signal acquisition time**

#### ■ Measurement time of DC resistance

When DC resistance  $R_{dc}$  is selected as a secondary parameter, DC resistance is measured following the measurement of AC impedance. ☞ “Figure 3-5 Measurement sequence” (c) Accordingly, the measurement time is the sum of the following three values:

- Measurement time of AC impedance
- Automatic range selection time of DC resistance (about  $75 \text{ ms} \times 1$  to  $75 \text{ ms} \times 5$ )  
The measurement range of DC resistance is automatically selected unless the range is held by remote control.  
The adjustment time of measurement range varies depending on the DC resistance.
- Additional time to measure DC resistance ☞ “Table 3-4 Example of measurement time” (DC)

#### ■ Measurement time when trigger delay time $\neq 0$

- Measurement time of AC impedance is extended by the amount of trigger delay time.
- Automatic range selection time of DC resistance is extended by about maximum amount of trigger delay time.
- Measurement time of DC resistance is extended by about  $(\text{trigger delay time} - 40 \text{ ms}) \times 2$  when trigger delay time  $> 40 \text{ ms}$ .

### 3.5.6.6 Correction of Measurement Error

The **ZM2371 / ZM2372** can correct the following errors that will occur by a measurement fixture or connection cable.

- **Zero correction**

OPEN correction	Error due to the stray admittance that remains when measurement terminals are opened
SHORT correction	Error due to the residual impedance that remains when measurement terminals are shorted

The zero correction can be made either in full frequency range or at one point of current frequency only.

- **LOAD correction**

Deviation from true value

Correction is made so that an error becomes zero when the standard having exact values is used under specific measurement conditions including the frequency and signal level. The LOAD correction cannot be made individually but executed together with the zero correction.

- **Cable length correction**

Additional error due to the connection cable

This correction is made for the measurement range of high impedance. For the measurement range of low impedance, originally additional error is small and therefore this correction presents less effect.

Setting of current correction is shown on the second line of measurement screen.

```
A100Ω  FAST256 Int OpShLd1m
CORRECTION
```

Op	OPEN: Indicates the OPEN correction is enabled. (Blank when disabled)
Sh	SHORT: Indicates the SHORT correction is enabled. (Blank when disabled)
Ld	LOAD: Indicates the LOAD correction is enabled. (Blank when disabled)
1m	0m / 1m / 2m / 4m: Indicates a setting of cable length correction.

#### ■ Measurement signal level when measuring correction values

The OPEN, SHORT or LOAD correction value is measured on the measurement signal level at that time. It is recommended to measure each correction value when the measurement signal level was changed since a correction value varies depending on the measurement signal level.

Varying measured value obtained every measurement of correction value means that the correction value will vary. When the measurement signal level is small, it is recommended to measure a correction value on larger measurement signal level. For the correction at specific frequency only, disable the correction once, and set large averaging count to restrict variations and measure correction values, and then set spot OPEN correction value and spot SHORT correction value, so that more exact correction can be made.

#### ■ DC bias when measuring correction values

Regardless of the DC bias setting, during the measurement of OPEN correction value and SHORT correction value, the DC bias is turned off automatically only during that measurement. With the DC bias turned on, the OPEN correction value and SHORT correction value cannot be measured.

### 3.5.6.7 OPEN Correction

Executing the OPEN correction can make the admittance zero when the measurement terminals are opened. For the OPEN correction value, a numeric value can be given, besides measurement by opening the measurement terminals.

With the measurement terminals open, press the **[SHIFT]** + **[OPEN]** keys to display the OPEN correction menu, and select Measure, so that the admittance when the measurement terminals are opened can be corrected to zero.

To set directly the OPEN correction value at current measurement frequency, first select FRMT to specify the format, and then select Entry to set a correction value, and finally select ON.

The operation of OPEN correction is executed with the OPEN correction menu.

#### **[SHIFT]** + **[ OPEN ]**

Press the **[SHIFT]** + **[OPEN]** keys to display the OPEN correction menu.

Lower limit or spot	Format	
OFF   ON		
<b>OPEN Correction:OFF 100 Hz-</b>	<b>FRMT: Cp-G</b>	Current setting
<b>0)OFF 1)ON 2)Measure 3)SPOT</b>	<b>&gt;NEXT</b>	Options (first page)
<b>4)LowFREQ 5)FRMT 6)Entry</b>	<b>&lt;PREV</b>	Options (second page)

- OFF** Disables the OPEN correction and returns to the measurement screen. OPEN correction value is held internally.
- ON** Enables the OPEN correction and returns to the measurement screen.
- Measure** Measures the OPEN correction value.  
Upon completion, enables the OPEN correction and returns to the measurement screen.
- SPOT** Displays the spot correction menu.  
When the spot correction is enabled, correction value is measured with current frequency only.
- LowFREQ** Displays the lower limit frequency setting menu for zero correction. This can prohibit the correction with low frequencies requiring long measurement time.
- FRMT** Displays the format setting menu for spot OPEN correction value.
- Entry** Displays the spot OPEN correction value input menu.

Perform the EXIT operation to return to the measurement screen.

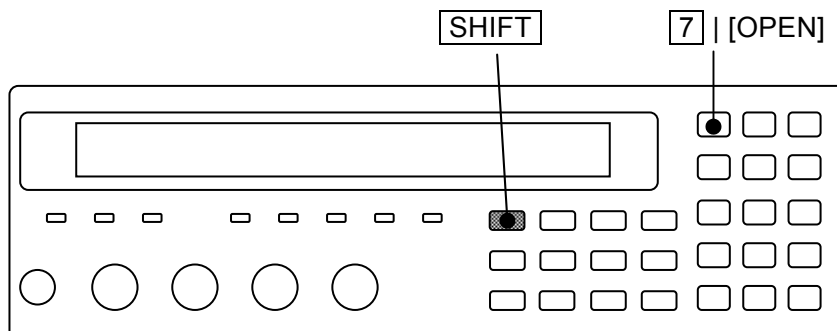

### ■ Measurement of OPEN correction value

First, place the measurement terminals in open state.

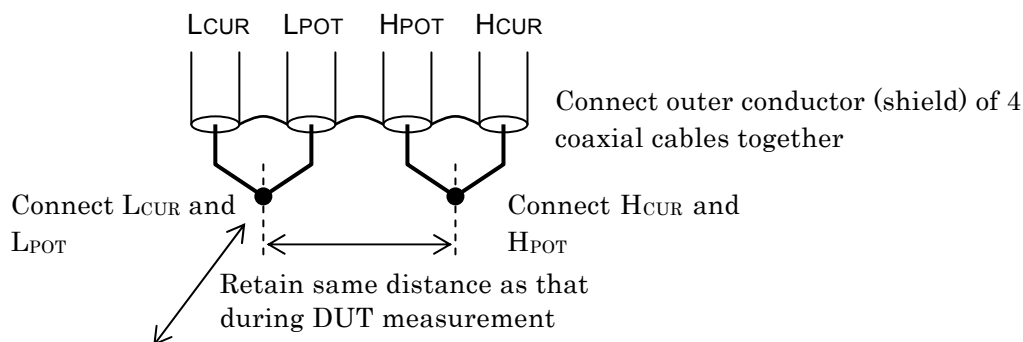

Retain positional relation to ambient dielectrics and conductors same as that during DUT measurement

**Figure 3-7 Terminal processing at OPEN correction**

To measure the OPEN correction value, press the **[SHIFT]** + **[OPEN]** keys to display the OPEN correction menu, and select Measure with a numeric key. With the initial setting, it will take about 23s to measure the correction value.

During the measurement of OPEN correction value, the following message is displayed.

```

OPEN Measurement (>1kΩ)
Running          9)ABORT

```

The measurement of OPEN correction value can be aborted by pressing the **[9]** key. The above message is also used as the correction value measurement abort menu.

Upon completion of OPEN correction value measurement, the OPEN correction is enabled, and the following completion message is displayed for a short time, and then the measurement screen comes back.

```

Completed Correction ON

```

However, when measured value  $\leq 1\text{k}\Omega$ , the following warning message is displayed.

```

Warning:Out of range

```

Same warning message is also displayed when the measurement failed by any reason. Even if this warning message is displayed, the **ZM2371 / ZM2372** use the obtained measured value as OPEN correction value. However, the previous OPEN correction value is held for the frequency at which the measurement failed.

This warning will disappear automatically. It also can be reset by operating any key.

Perform the EXIT operation to return to one-previous menu.

Even if either OPEN, SHORT, or LOAD correction is enabled, unless the following condition is fulfilled, any of OPEN, SHORT, or LOAD correction is not executed and the measured value becomes CORR Err.

Condition for correction: OPEN correction value ( $|Z|$ ) > SHORT correction value ( $|Z|$ )  $\times$  2

### ■ Direct correction frequencies

Whether the zero correction is made over full frequency range or at specific frequency only (spot correction) can be selected. DC is measured at all times.

When the correction is made over full frequency range, the frequency points at which correction value is measured directly are as follows:

DC / 0.001 / 0.002 / 0.005 / 0.01 / 0.015 / 0.022 / 0.033 / 0.05 / 0.07 / 0.1 / 0.15 / 0.22 / 0.33 / 0.5 / 0.7 / 1 / 1.5 / 2.2 / 3.3 / 5 / 7 / 10 / 15 / 20 / 30 / 40 / 55 / 70 / 90 / 110 / 130 / 165 / 220 / 330 / 400 / 500 / 600 / 800 / 1k / 1.2k / 1.5k / 2k / 2.5k / 3k / 4k / 5k / 6k / 8k / 10k / 12k / 15k / 20k / 25k / 30k / 40k / 50k / 60k / 80k / 100k [Hz]

For other frequencies, the correction value is obtained by interpolation. At a point near resonance point where the correction value varies largely depending on the frequency, an error by interpolation becomes large, and therefore it is recommended to use the spot correction.

### ■ Setting of correction lower limit frequency (common to OPEN correction and SHORT correction)

It will take time for measurement as the frequency becomes low. Accordingly, set the lower limit frequency appropriately when the correction is made in full frequency range. The initial value is 40Hz.

First, press the **[SHIFT]** + **[OPEN]** keys to display the OPEN correction menu, and select Low FREQ with the **[4]** key to display the correction lower limit frequency setting menu shown below.

**Lower Frequency = 100Hz**  
**1mHz to 1kHz**

Current setting

Range of settable values

Set the lowest frequency among frequencies to be measured. The correction lower limit frequency can be set with two significant digits (frequency  $\geq 10\text{mHz}$ ) or 1mHz (frequency  $< 10\text{mHz}$ ).

If a setting is made or the EXIT operation is performed, one-previous menu comes back.

The correction lower limit frequency is displayed in the OPEN correction menu.

Correction lower limit frequency

**OPEN Correction:OFF      100Hz-      FRMT: Cp-G**

First line

The correction value is measured in a range from the highest direct correction frequency point which does not exceed the set correction lower limit frequency to the measurement upper limit frequency. For the correction value at a direct correction point where a new correction value is not measured, the last value is held and used for correction calculation as it is. When the correction lower limit frequency is lowered, the interpolated correction value may be incorrect unless the correction value is measured again.

The correction lower limit frequency is common to the OPEN correction and SHORT correction. If Low FREQ is selected with the SHORT correction menu, same correction lower limit frequency setting menu as that of OPEN correction is displayed. Also, the correction lower limit frequency is displayed in the SHORT correction menu, too.

### ■ Setting of spot correction (common to OPEN correction and SHORT correction)

When the zero correction is made with current frequency only, set the spot correction to ON. If the measurement is executed with specific frequency only, the measurement time of correction value is short and an error of correction value, which occurs by interpolation in other than direct correction value frequency, will not occur. The spot correction of DC resistance is not supported.

First, press the **[SHIFT]** + **[OPEN]** keys to display the OPEN correction menu, and select SPOT with the **[3]** key to display the spot correction menu as shown below.

<b>SPOT Correction:OFF</b> <b>0)OFF 1)ON</b>	Current setting Options
---	----------------------------

- OFF** Disables the spot correction.  
 The correction value is measured in a range from the specified lower limit frequency to the maximum frequency.  
 The spot correction value is not used for correction.
- ON** Enables the spot correction.  
 The correction value is measured with current measurement frequency only.  
 The spot correction value is used for correction if the measurement frequency is same as the spot correction frequency. If not same, the spot correction value is not used.

If a setting is made or the EXIT operation is performed, one-previous menu comes back. When the spot correction is enabled, "SPOT" is displayed in place of correction lower limit frequency in the OPEN correction menu.

Spot correction is enabled

<b>OPEN Correction:OFF</b> <b>SPOT</b> <b>FRMT: Cp-G</b>	First line
--	------------

The setting whether the spot correction is enabled or disabled is common to the OPEN correction and SHORT correction. The spot correction can be set from the SHORT correction menu in the same manner. When the spot correction is enabled, "SPOT" is displayed on the first line of SHORT correction menu.



### ■ Spot OPEN correction value is given with a numeric value or read

The spot OPEN correction value at current measurement frequency can be given with a numeric value or it can be read.

After specifying the format of spot OPEN correction value, input or display the spot OPEN correction value. First, press the **[SHIFT]** + **[OPEN]** keys to display the OPEN correction menu, and select FRMT with a numeric key.

FRMT: The format setting menu for the spot OPEN correction value is as shown below.

**Format:Cp-G**  
**0)G-B 1)Cp-G**

Current setting  
 Options

G Stray conductance (unit: G)  
 B Stray susceptance (unit: S)  
 Cp Stray capacitance  
 (parallel equivalent circuit, unit: F)

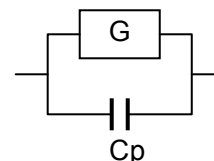
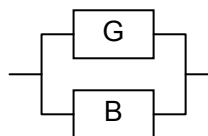

Select the format with a numeric key.

If a setting is made or the EXIT operation is performed, one-previous menu comes back.

Next, select Entry with the OPEN correction menu.

Entry: The spot OPEN correction input menu is as shown below.

**Co-OPEN=Cp: +123.456pF G:+1.23456μS**  
**±(0.0000p to 999999M) Z>1kΩ 1.0000kHz**

Current value  
 Range of settable values

Spot OPEN correction frequency

Following the set format of spot OPEN correction value, the spot OPEN correction value is displayed. The above screen shows an example of FRMT Cp-G. The frequency displayed at the lower right of screen is the one at the time when the spot OPEN correction value was measured or set, and it is not current measurement frequency. Initially, the cursor exists on the previous value, and when the previous value is input and entered with the **[ENTR]** key, the cursor moves to the next value, indicating that the next value can be input. The cursor can be moved between previous and next by pressing the **[BS]** | **[PREV]** or **[EXP]** | **[NEXT]** key.

In either previous or next, if a value is set, the measurement frequency at that time is recorded as the spot correction frequency.

Perform the EXIT operation to return to one-previous menu.

If the spot OPEN correction value is set, the OPEN correction is disabled. Set the OPEN correction to ON (enabled) when the set spot OPEN correction value is used.

Though the warning message will be displayed for the input of correction value of impedance  $\leq 1\text{k}\Omega$ , it is set as it is as the spot OPEN correction value.

If both previous and next values are zero, it is equivalent to the setting that the spot OPEN correction is disabled.

### 3.5.6.8 SHORT Correction

Executing the SHORT correction can make the impedance zero when the measurement terminals are shorted. For the SHORT correction value, a numeric value can be given, besides measurement by shorting the measurement terminals.

With the measurement terminals short, press the **[SHIFT]** + **[SHORT]** keys to display the SHORT correction menu, and select Measure, so that the impedance when the measurement terminals are shorted can be corrected to zero.

To set directly the SHORT correction value at current measurement frequency, first select FRMT to specify the format, and then select Entry to set a correction value, and finally select ON.

The operation of SHORT correction is executed with the SHORT correction menu.

#### **[SHIFT]** + **[SHORT]**

Press the **[SHIFT]** + **[SHORT]** keys to display the SHORT correction menu.

Lower limit or spot	Format	
OFF   ON		
<b>SHORT Correction: OFF 100 Hz- FRMT: Ls-Rs</b>		Current setting
<b>0)OFF 1)ON 2)Measure 3)SPOT &gt;NEXT</b>		Options (first page)
<b>4)LowFREQ 5)FRMT 6)Entry &lt;PREV</b>		Options (second page)

- OFF Disables the SHORT correction and returns to the measurement screen. SHORT correction value is held internally.
- ON Enables the SHORT correction and returns to the measurement screen.
- Measure Measures the SHORT correction value.  
Upon completion, enables the SHORT correction and returns to the measurement screen.
- SPOT Displays the spot correction menu.
- LowFREQ Displays the lower limit frequency setting menu for zero correction.
- FRMT Displays the format setting menu for spot SHORT correction value.
- Entry Displays the spot SHORT correction value input menu.

The spot correction menu and the lower limit frequency setting menu are common to the OPEN correction and SHORT correction. Same results can be obtained if making a setting on either side. For details ☞ **“3.5.6.7 OPEN Correction”**.

Perform the EXIT operation to return to the measurement screen.

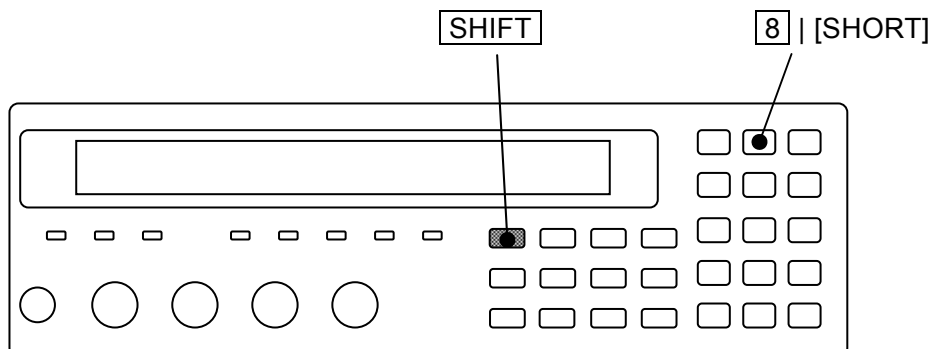

■ **Measurement of SHORT correction value**

First, short the measurement terminals.

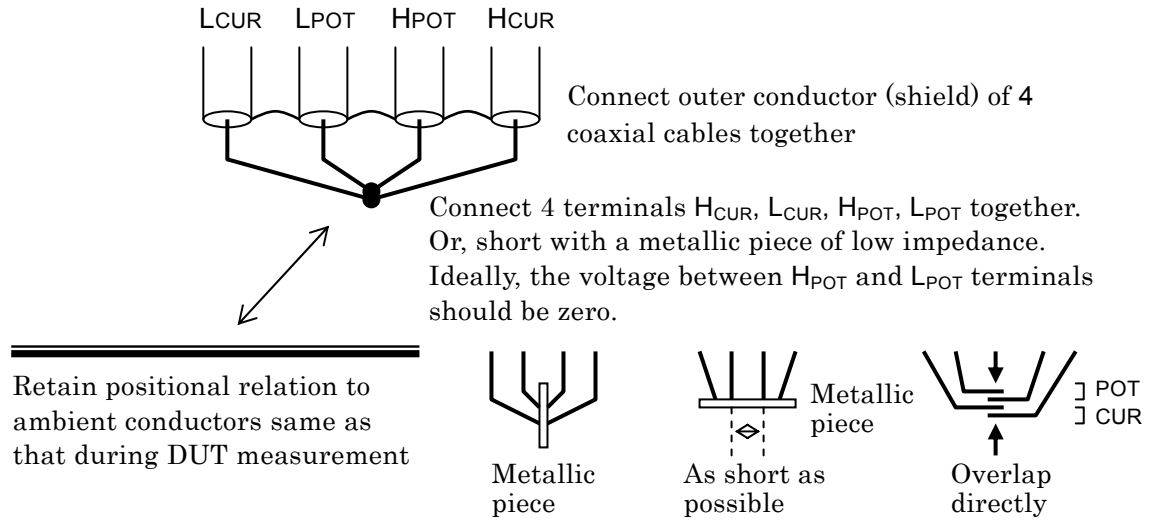

Retain positional relation of the cables, particularly the relation of H<sub>CUR</sub> - L<sub>CUR</sub> current loop and H<sub>POT</sub> - L<sub>POT</sub> voltage loop same as that during DUT measurement. The loop should be as small as possible to reduce the electromagnetic coupling.

**Figure 3–8 Terminal processing at SHORT correction**

To measure the SHORT correction value, press the **[SHIFT]** + **[SHORT]** keys to display the SHORT correction menu, and select Measure with a numeric key.

During the measurement of SHORT correction value, the following message is displayed.

```

SHORT Measurement (<900Ω)
Running 9)ABORT
    
```

The measurement of SHORT correction value can be aborted by pressing the **[9]** key.

Upon completion of SHORT correction value measurement, the SHORT correction is enabled, and the following completion message is displayed for a short time, and then the measurement screen comes back.

```

Completed Correction ON
    
```

However, when measured value  $\leq 900k\Omega$ , the following warning message is displayed.

```

Warning:Out of range
    
```

Same warning message is also displayed when the measurement failed by any reason. Even if this warning message is displayed, the **ZM2371 / ZM2372** use the obtained measured value as SHORT correction value. However, the previous SHORT correction value is held for the frequency at which the measurement failed.

This warning will disappear automatically. It also can be reset by operating any key.

Perform the EXIT operation to return to one-previous menu.

### ■ Spot SHORT correction value is given with a numeric value or read

The spot SHORT correction value at current measurement frequency can be given with a numeric value or it can be read.

After specifying the format of spot SHORT correction value, input or display the spot SHORT correction value. First, press the **[SHIFT]** + **[SHORT]** keys to display the SHORT correction menu, and select FRMT with a numeric key.

FRMT: The format setting menu for the spot SHORT correction value is as shown below.

<b>Format:Ls-Rs</b>	Current setting
<b>0)Rs-X 1)Ls-Rs</b>	Options

Rs	Residual resistance (unit: $\Omega$ )	—	<b>Rs</b>	—	<b>X</b>	—	<b>Rs</b>	—	<b>Ls</b>	—
X	Residual reactance (unit: $\Omega$ )									
Ls	Residual inductance (unit: H)									

Select the format with a numeric key.

If a setting is made or the EXIT operation is performed, one-previous menu comes back.

Next, select Entry with the SHORT correction menu.

Entry: The spot SHORT correction input menu is as shown below.

<b>Co-SHORT= Rs:+123.456m<math>\Omega</math> X :+123.456m<math>\Omega</math></b>	Current value
<b><math>\pm(0.0000p</math> to <math>999999M)</math> Z&lt;900<math>\Omega</math> 1.0000kHz</b>	Range of settable values

Spot SHORT correction frequency

Following the set format of spot SHORT correction value, the spot SHORT correction value is displayed. The above screen shows an example of FRMT Rs-X. The frequency displayed at the lower right of screen is the one at the time when the spot SHORT correction value was measured or set, and it is not current measurement frequency.

Initially, the cursor exists on the previous value, and when the previous value is input and entered with the **[ENTR]** key, the cursor moves to the next value, indicating that the next value can be input.

The cursor can be moved between previous and next by pressing the **[BS]** | **[PREV]** or **[EXP]** | **[NEXT]** key.

In either previous or next, if a value is set, the measurement frequency at that time is recorded as the spot correction frequency.

Perform the EXIT operation to return to one-previous menu.

If the spot SHORT correction value is set, the SHORT correction is disabled. Set the SHORT correction to ON (enabled) when the set spot SHORT correction value is used.

Though the warning message will be displayed for the input of correction value of impedance  $\geq 900\Omega$ , it is set as it is as the spot SHORT correction value.

If both previous and next values are zero, it is equivalent to the setting that the spot SHORT correction is disabled.

**3.5.6.9 LOAD Correction**

Based on exact standard, the LOAD correction gives a correction value to the **ZM2371 / ZM2372** so that more correct measured value can be obtained under specific measurement conditions. The LOAD correction value can be given with a numeric value, besides acquisition by measuring exact standard.

Connect exact standard having almost same value as DUT, and press the **[SHIFT] + [LOAD]** keys to display the LOAD correction menu, and select Measure, and thus the correction can be made so that the measured value is equal to the calibrated value of the standard.

Measure the LOAD correction value at one point of current measurement frequency. When the measurement frequency was changed, measure the LOAD correction value again. The LOAD correction of DC resistance is not supported.

To set directly the LOAD correction value, first select FRMT to specify the format, and then select Entry to set a correction value, and finally select ON.

The operation of LOAD correction is executed with the LOAD correction menu.

**[SHIFT] + [LOAD]**

Press the **[SHIFT] + [LOAD]** keys to display the LOAD correction menu.

<b>LOAD Correction:OFF</b>	<b>FRMT: Cs-D</b>	Current setting		
<b>0)OFF</b>	<b>1)ON</b>	<b>2)Measure</b>	<b>&gt;NEXT</b>	Options (first page)
<b>3)FRMT</b>	<b>4)STD</b>	<b>5)Entry</b>	<b>&lt;PREV</b>	Options (second page)

- OFF** Disables the LOAD correction and returns to the measurement screen. LOAD correction value is held internally.
- ON** Enables the LOAD correction and returns to the measurement screen. The OPEN correction and SHORT correction are also enabled.
- Measure** Measures the standard for LOAD correction. Correction value under specific measurement frequency, measurement signal level, measurement range, cable length, or zero correction (OPEN, SHORT) can be obtained.
- FRMT** Displays the format setting menu for LOAD correction.
- STD** Displays the standard value input menu for LOAD correction.
- Entry** Displays the LOAD correction value input menu.

Perform the EXIT operation to return to the measurement screen.

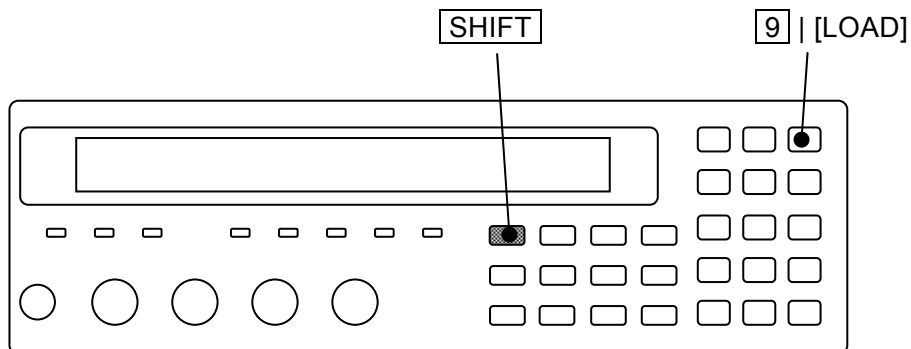

### ■ Measurement of LOAD correction value

To obtain LOAD correction value by measuring the standard, operate through the following steps:

- 1) Set measurement conditions: Measurement frequency, measurement signal level, measurement range, measurement speed, averaging count, triggered drive, trigger delay time, cable length, zero correction (OPEN, SHORT), and DC bias. (LOAD correction value is measured by the set measurement conditions)
- 2) Specify the format for LOAD correction value.  
This format is applied to the standard value for LOAD correction and the LOAD correction value.
- 3) Enter standard value for LOAD correction (to give standard value under set measurement conditions).
- 4) Measure the standard for LOAD correction.

Whichever value, zero correction or LOAD correction, may be measured first.

Measure the LOAD correction value under same measurement conditions as when DUT is measured, since the LOAD correction value may vary depending on the measurement conditions such as measurement range or signal level.

Hold the measurement range properly, and when the measurement range was changed, the LOAD correction should be made again. Also, set the measurement speed, averaging count, and trigger delay time under which the measurement can be executed stably.

First, press the **[SHIFT]** + **[LOAD]** keys to display the LOAD correction menu and select FRMT with a numeric key.

FRMT: The format setting menu for LOAD correction is as shown below.

<b>LOAD Standard format: Cp-D</b>	Current setting
<b>0)Cp-D 1)Cs-D 2)Rp-Cp 3)Rs-Ls &gt;NEXT</b>	Options (first page)
<b>4)Rs-X 5)Z-θ &lt;PREV</b>	Options (second page)

Select the format of the standard value to be given.

If a setting is made or the EXIT operation is performed, one-previous screen comes back.

Next, select the STD with the LOAD correction menu.

STD: The standard value input menu for LOAD correction is as shown below.

<b>LOAD STD Cp:+1.23456μF D:+234.56m</b>	Current setting
<b>±(0.0000p to 999999M)</b>	Range of settable values

This screen shows an example of Cp-D format.

Input the calibrated value of the standard to be measured.

Initially, the cursor exists on the previous value. When the previous value is input and entered with the **[ENTR]** key, the cursor moves to the next value, indicating that the next value can be input

The cursor can be moved between previous and next by pressing the **[BS]** | **[PREV]** or **[EXP]** | **[NEXT]** key.

Perform the EXIT operation to return to one-previous menu.

Finally, measure the standard.

Install the standard for LOAD correction.

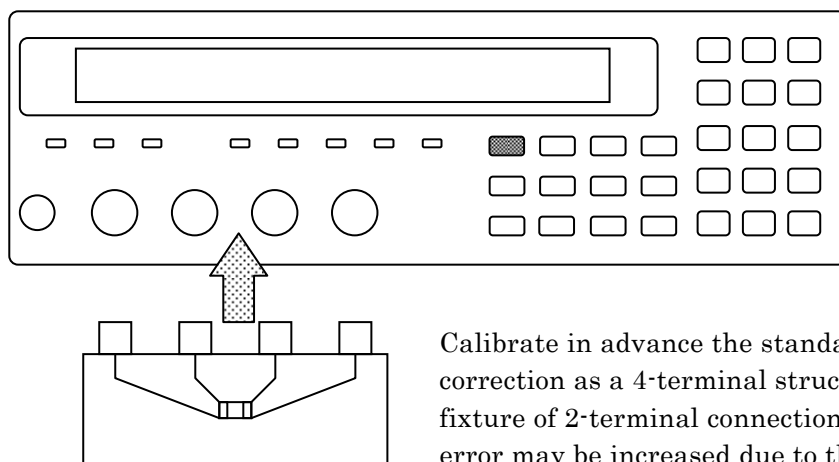

Calibrate in advance the standard for LOAD correction as a 4-terminal structure. If the test fixture of 2-terminal connection is used, an error may be increased due to the influence of contact resistance.

**Figure 3–9 Installation of standard for LOAD correction**

To measure LOAD correction value, select Measure with the LOAD correction menu. When the LOAD correction menu is not displayed, first, press the **[SHIFT]** + **[LOAD]** keys to display the LOAD correction menu.

During the measurement of standard for LOAD correction, the following message is displayed.

```
LOAD Standard Measurement  +/-20%
Running                    9)ABORT
```

The measurement of LOAD correction value can be aborted by pressing the **[9]** key.

Upon successful completion of LOAD correction value measurement, the LOAD correction is enabled, and the following completion message is displayed for a moment, and then the measurement screen comes back.

```
Completed Correction ON
```

When the standard for LOAD correction is measured and the measured value different more than 20% from the set standard value is obtained, the following warning message is displayed.

```
Warning:Out of range
```

Same warning message is also displayed when the measurement failed by any reason. Even if the obtained LOAD correction value is out of range, the LOAD correction is executed based on the obtained value. However, when the measurement failed, the last LOAD correction value is held.

This warning will disappear automatically. It also can be reset by operating any key.

### ■ LOAD correction value is given with a numeric value or read

The LOAD correction value can be given with a numeric value or it can be read.

After specifying the format of LOAD correction value, input or display the LOAD correction value.

First, press the **[SHIFT]** + **[LOAD]** keys to display the LOAD correction menu, and select FRMT with a numeric key.

FRMT: The format setting menu for the LOAD correction value is as shown below.

<b>LOAD Standard format: Cp-D</b>	Current setting
<b>0)Cp-D 1)Cs-D 3)Rp-Cp 4)Rs-Ls &gt;NEXT</b>	Options (first page)
<b>5)Rs-X 6)Z-θ &lt;PREV</b>	Options (second page)

Select the format with a numeric key.

If a setting is made or the EXIT operation is performed, one-previous menu comes back.

Next, select Entry with the LOAD correction menu.

Entry: The LOAD correction value input menu is as shown below.

<b>LOAD Cp:+1.02345μF D:+123.456m</b>	Current value
<b>±(0.0001p to 999999M) 1.0000kHz</b>	Range of settable values

Spot LOAD correction frequency

This screen shows an example of Cp-D format.

Following the set format of spot LOAD correction value, the spot LOAD correction value is displayed. The above screen shows an example of FRMT Cp-D. The frequency displayed at the lower right of screen is the one at the time when the LOAD correction value was measured or set, and it is not current measurement frequency.

For the LOAD correction value, enter the measured value obtained when the standard for LOAD correction was measured without OPEN correction, SHORT correction and LOAD correction, or equivalent value.

Initially, the cursor exists on the previous value, and when the previous value is input and entered with the **[ENTR]** key, the cursor moves to the next value, indicating that the next value can be input.

The cursor can be moved between previous and next by pressing the **[BS]** | **[PREV]** or **[EXP]** | **[NEXT]** key.

Giving a value which cannot be handled by **ZM2371 / ZM2372** such that the impedance or admittance cannot be calculated causes an error, resulting in a setting failure.

If the spot LOAD correction value is set, the LOAD correction is disabled. Set the LOAD correction to ON (enabled) when the set LOAD correction value is used.

Perform the EXIT operation to return to one-previous menu.



### 3.5.6.10 Cable Length Correction

The cable length correction corrects an additional error due to the connection cable between **ZM2371 / ZM2372** and DUT.

The **ZM2371 / ZM2372** use coaxial cables of impedance  $50\Omega$  (cable capacitance = about  $100\text{pF/m}$ ) and the length of four cables must be same. Using the cables having different characteristics may increase a correction error. Particularly for the  $L_{\text{CUR}}$  and  $L_{\text{POT}}$  cables, the cables having same specified characteristics and length should be used.

The cable length correction is operated with the cable length correction menu.

#### **SHIFT** + [ **CABLE** ]

Press the **SHIFT** + [ **CABLE** ] keys to display the Cable Length correction menu.

<b>CABLE Length:0m</b>	Current setting
<b>0)0m 1)1m 2)2m 3)4m 4)4m</b>	Options

Select the cable length with a numeric key according to the actual cable length.

4m can be selected with either **3** key or **4** key.

If a selection is made or the EXIT operation is performed, the measurement screen comes back.

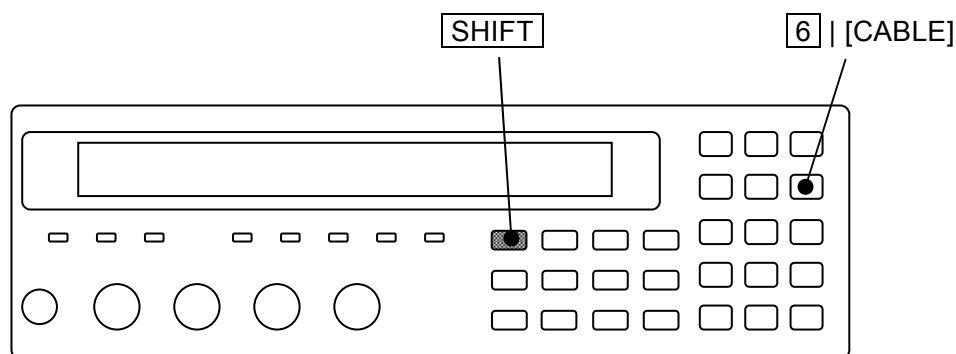



## 4. ADVANCED OPERATIONS

4.1 Restricting the Variation of Measured Values (Averaging)...	4-2
4.2 Displaying the Deviation from the Reference Value .....	4-3
4.3 Sorting the Part (Comparator).....	4-6
4.4 Connecting to the Part handler (Handler Interface).....	4-15
4.5 Changing the Contents Displayed on the Second Line of Measurement Screen (Auxiliary Display) .....	4-22
4.6 Saving/Recalling the Setting and Correction Value into the Memory.....	4-24
4.7 Setting the Contact Check .....	4-26
4.8 Using the DC Bias.....	4-30
4.9 Disabling the Key-Operation of Panel .....	4-35
4.10 Initializing of All Settings .....	4-36
4.11 Self-Diagnosis.....	4-39
4.12 Checking the Version .....	4-40

## 4.1 Restricting the Variation of Measured Values (Averaging)

When measured values vary due to the noise, it is able to restrict the variation by the averaging function.

### **SHIFT** + **AVERAGE**

Press the **SHIFT** + **AVERAGE** keys to display the averaging count setting menu.

<b>Averaging times = 256, ON</b> <b>1 to 256</b>
---

Current setting  
Range of settable values

Enter the averaging count with the numeric key, and press the **ENTR** key.

If a setting is made or the EXIT operation is performed, the measurement screen comes back.

If the averaging count is set to “1”, the averaging function is disabled (OFF).

If the averaging count is set to “2 to 256”, the averaging function is enabled (ON).

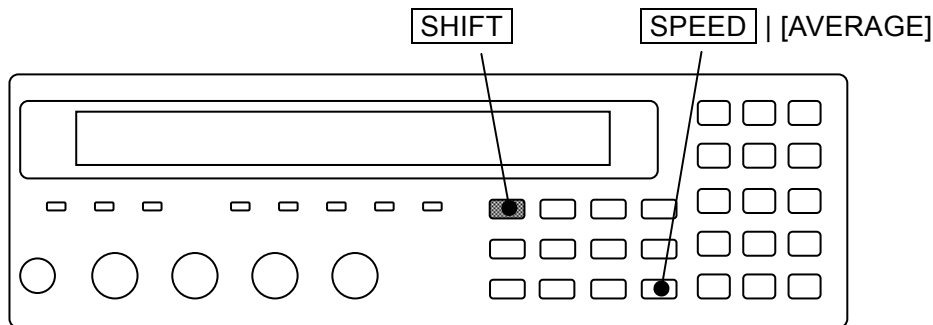

The current averaging count is displayed on the second line in measurement screen.

A100kΩ FAST <b>256</b> Int OpShLd1m . . . . .
SPEED/AVERAGE

Averaging count: 1 to 256

When the averaging function is enabled, the signal acquisition time becomes the multiple number of the averaging count. To sensitively adjust the measurement speed in consideration of the balance with the variation or fluctuation of measured values, speed up the measurement speed and adjust it by the averaging count.

Even if the measurement speed is RAP or FAST, increase the averaging count, so that the measurement accuracy achieved when measurement speed is MED can be used when the signal acquisition time of MED is exceeding.

## 4.2 Displaying the Deviation from the Reference Value

It is able to display the deviation or deviation% from the reference value of measured values. To display the deviation or deviation%, previously specify the given primary and secondary parameters. Also, set the reference value for obtaining the deviation.

### ■ Displaying the deviation of primary parameter

#### **SHIFT** + [ $\Delta$ Pri]

Press the **SHIFT** + [ $\Delta$ Pri] keys to display the deviation display menu of primary parameter.

	Display format	Reference value for deviation display	
	<b>Deviation Pri:ABS</b>	<b>REF:+1.23456<math>\mu</math>F</b>	Current setting
	<b>0)ABS 1)DEV 2)DEV% 3)REF</b>		Options
ABS	Displays the measured value as is. (Initial value)		
DEV	Displays the deviation from reference value. Deviation = Measured value – Reference value		
DEV%	Displays the deviation % from the reference value. Deviation % = ((Measured value – Reference value) / Reference value) $\times$ 100		
REF	Display the reference value setting menu of primary parameter.		

Select one of ABS, DEV or DEV% as the display format with the numeric key.

To display the deviation or deviation%, previously set the reference value.

If a setting is made or the EXIT operation is performed, the measurement screen comes back.

REF: The reference value setting menu of primary parameter is as follows.

<b>Pri Reference:+1.23456<math>\mu</math>F</b>	Current setting
<b><math>\pm</math>(0.0000p to 999999M)</b>	Range of settable values

Enter the numeric value and press the **ENTR** key or input of exponential part **EXP** + [ $\mu$ ] keys for instance.

If a setting is made or the EXIT operation is performed, one-previous menu comes back.

When the deviation or deviation% is selected, the “ $\Delta$ ” displayed in front of measured value of primary parameter.

<b><math>\Delta</math>Cp:+ 23.456 %</b>	<b>D:+0.12345</b>	<b>1.0000k</b>
---	-------------------	----------------

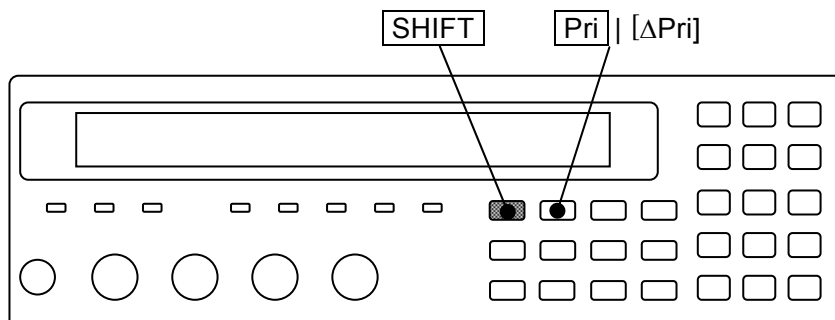

■ Displaying the deviation of secondary parameter

**SHIFT** + [ ΔSec ]

Press the **SHIFT** + [ΔSec] keys to display the deviation display menu of secondary parameter.

Display format	Reference value for deviation display	
<b>Deviation Sec:ABS</b>	<b>REF:+1.23456</b>	Current setting
<b>0)ABS 1)DEV 2)DEV% 3)REF</b>		Options

ABS Displays the measured value as is. (Initial value)

DEV Displays the deviation from reference value.

Deviation = Measured value – Reference value

DEV% Displays the deviation % from the reference value.

Deviation % = ((Measured value – Reference value) / Reference value) × 100

REF Display the reference value setting menu of secondary parameter.

Select one of ABS, DEV or DEV% as the display format with the numeric key.

To display the deviation or deviation%, previously set the reference value.

If a setting is made or the EXIT operation is performed, the measurement screen comes back.

REF: The reference value setting menu of secondary parameter is as follows.

<b>Sec Reference:+1.23456</b>	Current setting
<b>±(0.0000p to 999999M)</b>	Range of settable values

Enter the numeric value and press the **ENTR** key or input of exponential part **EXP** + [μ] keys for instance.

If a setting is made or the EXIT operation is performed, one-previous menu comes back.

When the deviation or deviation% is selected, the “Δ” displayed in front of measured value of secondary parameter.

<b>Cp:+12.3456μF</b>	<b>ΔD :+0.12345</b>	<b>1.0000k</b>
----------------------	---------------------	----------------

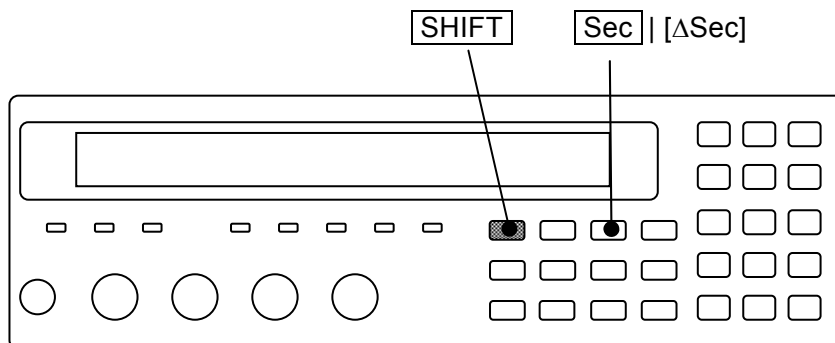

The displaying ranges for deviation% both for primary and secondary parameters are shown as follows:

Deviation%             $\pm(0.000 \text{ to } 999.999)$ , Fixed decimal place

The unit of reference value depends on the parameter. (ex.:  $Z \rightarrow \Omega$ ,  $\theta \rightarrow ^\circ$ )

When the parameter is changed, the unit to be displayed is also changed.

(ex.:  $C, 2.2\text{mF} \rightarrow L, 2.2\text{mH}$ )

When the primary or secondary parameter to be displayed is changed, the display is changed from the one of deviation and deviation% into the other of original measured value as is for both primary and secondary parameters. To display the deviation or deviation%, previously set the given primary and secondary parameters. Also confirm that “ $\Delta$ ” is displayed in front of measured value.

The display format for measured value and the comparison format for comparator are common. Also the reference value for obtaining the deviation is common for both display and comparator. For both primary and secondary parameters, even if either display or comparator is set up, the same display format or comparison format or reference value is obtained.

---

## 4.3 Sorting the Part (Comparator)

For **ZM2371 / ZM2372**, up to 14 bins for primary parameter and one set range for secondary parameter can be set to sort the comparator results.

However, comparison of BIN10-BIN14 is not conducted for **ZM2371**, so that the classified number of primary parameter is up to 9.

### ■ Limit comparison

The remote control allows the use of limit comparison function wherein sorting is done while upper/lower limit (one set) of primary parameter and upper/lower limit (one set) of secondary parameter are being set. The limit comparison function is not made into effect through the panel.

Once the limit comparison function is made into effect, independent of the setting for Bin sorting, comparison can be done only for one set (common to BIN1 for Bin sorting) of upper/lower limit values of primary parameter and one set (common to secondary parameter for Bin sorting) of upper/lower limit values of secondary parameter. In this case, the comparison for Bin 2 to BIN14 is not conducted.

For detail, see the explanation for each command stated in the chapter 5 “5.6.3.2 Sub system command”

:CALCulate:COMParator[:STATe] Command

:CALCulate1:LIMit Command tree

:CALCulate2:LIMit Command tree



■ Output of comparator result

The comparator result are displayed on the front panel and also outputted from the Handler interface of rear panel (ZM2371 does not have the handler interface). The relation between measured values of primary/secondary parameters, setting of upper/lower limit values and comparator result is as follows.

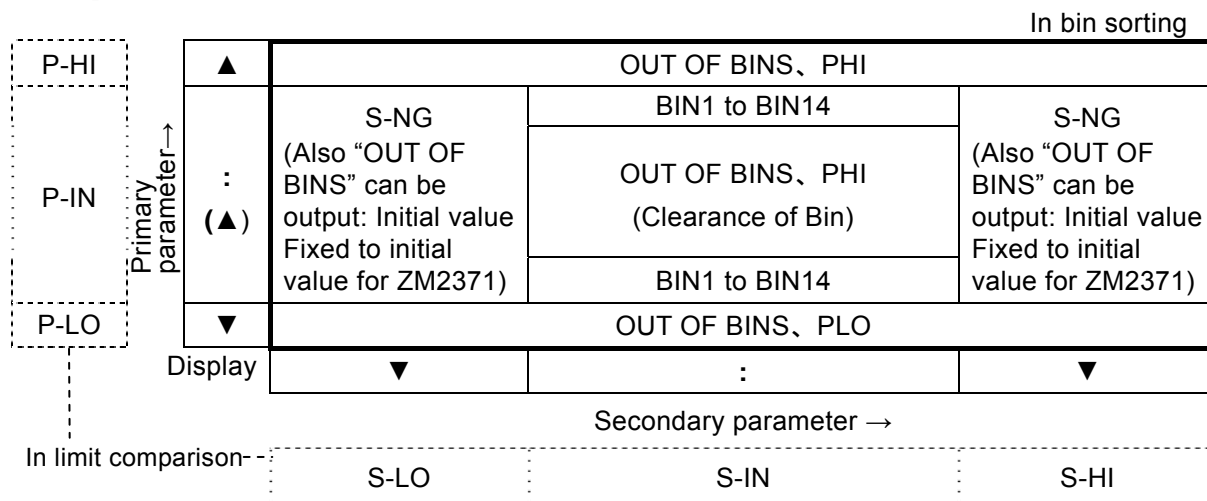

Figure 4-1 Output of comparator result

For the signal name, see “4.4 Connecting to the Part Handler (Handler Interface)”. The limit comparison also conduct the following comparison. The parameter, which does not conduct comparison, should be regarded as pass one.

- IN Both primary parameter and secondary parameter are passed
  - OUT OF BINS Either or both of primary and secondary parameters is failed (initial value)
  - S-NG Primary parameter is acceptable but secondary parameter is failed.
- However, when the correct value cannot be obtained due to an error, it can be classified as P-HI, S-HI.

■ Displaying the measured value when comparator function is enabled

When comparator function is enabled, the COMPTR lamp on the left of front panel lights up. The measured values are displayed as follows when comparator function is enabled.

- ▲ The primary parameter is larger than any upper limits or are between Bins.
- :
- ▼ The primary parameter is less than any lower limits.

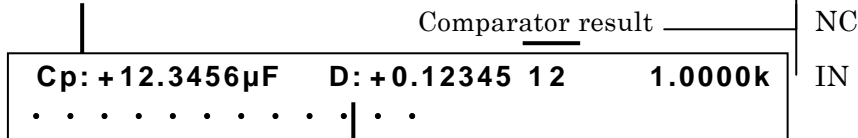

- 1 to 14: Bin Number
- OUT : OUT OF BINS
- SNG : S-NG
- ERR
- NC
- IN

- ▲ The secondary parameter is larger than the upper limit.
- :
- ▼ The secondary parameter is less than lower limit.

The upper or lower limit values of comparator can be displayed on the lower line.  
 For detail . . . “4.5 Changing the Contents Displayed on the Second Line of Measurement Screen (Auxiliary Display)”.

■ **Setting the Comparator**

The comparator function is set with the comparator setting menu.

**SHIFT** + [ **COMPRTR** ]

Press the **SHIFT** + [COMPRTR] keys to display the comparator setting menu.

When limit comparison, **L/U**

Comparator function ON/OFF      Comparison format of primary parameter

<b>Comparator:OFF</b>	<b>ABS</b>	Current setting
<b>0)OFF 1)ON 2)DEV</b>	<b>&gt;NEXT</b>	Options (first page)
<b>3)CLEAR 4)LIMIT</b>	<b>&lt;PREV</b>	Options (second page)

- OFF      Disables the comparator function (Bin sorting). (Initial value)
- ON      Enables the comparator function (Bin sorting).
- DEV      Displays the primary parameter deviation comparison menu for comparator.
- CLEAR    Displays the comparator initializing menu.
- LIMIT    Displays the comparator upper/lower limit setting menu.
- L/U      Appears when primary or secondary parameter comparison function is enables. The limit comparison function cannot be made enabled through the panel. Turning on/off of comparator function disables the limit comparison function of primary/secondary parameters.

If a setting is made or the EXIT operation is performed, the measurement screen comes back.

**COMPRTR lamp**

When the comparator function is enabled, the COMPRTR lamp on front panel lights up. It also lights up when the limit comparison function is enabled.

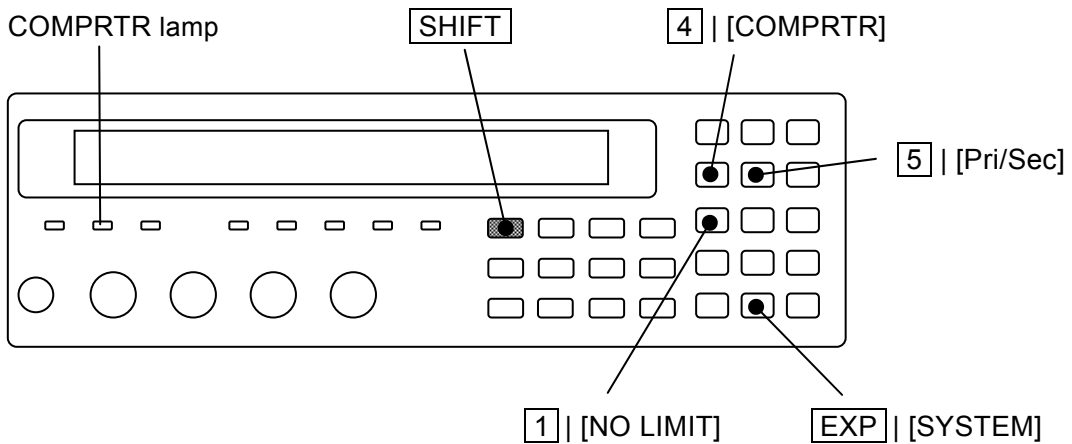

■ **Sorting the primary and secondary parameters with the deviation**

When the primary and secondary parameters are display format of deviation or deviation%, they are sorted by the values of deviation or deviation%.

The comparison format of primary parameter can be set in the comparator setting menu. Since the comparison format (=Display format) and the reference value for obtaining a deviation are common to both display and comparator, they may be set for either display or comparator.

Since it is impossible to set the comparison format of secondary parameter in the comparator setting menu, alternatively use the setting for display format.

Select the DEV with the comparator setting menu, the primary parameter deviation comparison menu for the comparator is displayed.

DEV: The primary parameter deviation comparison menu is as follows:

<u>Comparison format</u>	<u>Reference value for deviation comparison</u>	
<b>Deviation:ABS</b>	<b>REF:+1.23456μF</b>	Current setting Options
<b>0)ABS 1)DEV 2)DEV% 3)REF</b>		
ABS	Conducts the comparison according to the original measured values. (Initial value)	}
DEV	Conducts the comparison according to the deviation from the reference values.	
DEV%	Conducts the comparison according to the deviation% value from the reference values.	
REF	Displays the primary parameter reference value setting menu for the comparison of deviation.	

Select one of ABS, DEV or DEV% as the comparison format by the numeric key. To display the deviation or deviation%, previously set the reference value.

If a setting is made or the EXIT operation is performed, one-previous menu comes back.

REF: The deviation comparison of primary parameter reference value setting menu is as follows.

<b>DEV Reference:+1.23456μF</b>	Current setting
<b>±(0.0000p to 999999M)</b>	Range of settable values

Enter the numeric value, and press the input of exponential part **EXP** + **[μ]** keys for instance.

If a setting is made or the EXIT operation is performed, the measurement screen comes back.

■ **The display format for the lower/upper limit values and reference values, and unit**

The lower limit value, upper limit value and reference values are construed according to the type of display parameter or the display format.

For example, “F” is used as the unit of lower/upper limit value when displaying/sorting the capacitance by the absolute value or deviation, meanwhile “%” is used as the unit when displaying/sorting the capacitance by the deviation%

The following table shows the case when the lower limit value=1, upper limit value=2 and reference value=3 are set during sorting the inductance (L).

Display format	Lower limit value (=1)	Upper limit value (=2)	Ref. value (=3)
ABS	1H	2H	3H
DEV	Deviation is 1H (equivalent to 4H for original measured value)	Deviation is 2H (equivalent to 5H for original measured value)	3H
DEV%	Deviation is 1% (equivalent to 3.03H for original measured value)	Deviation is 2% (equivalent to 3.06H for original measured value)	3H

■ **Initializing the setting of comparator**

To newly set the upper/lower limit value of comparator, it will be convenient to initialize the setting at first.

To initialize the upper/lower limit value, select the CLEAR in the comparator setting menu, and the following comparator initializing menu is displayed.

<b>Comparator CLEAR</b> 1)Execute	Option
<b>Done</b>	Completion message

Perform the EXIT operation to return to one-previous menu.

Press the 1 key to excute the initialization, and the completion message will be displayed for a short time, and then one-previous menu will come back.

**Table 4-1 Initialization contents of comparator**

Item	Initial value	Item	Initial value
Comparator function (Bin sorting)	OFF	Limit comparison	OFF
Sorting for BIN1	ON	All upper limit values (Value, ON/OFF)	0, OFF (No Limit)
Sorting for BIN2 to BIN14	OFF	All lower limit values (Value, ON/OFF)	0, OFF (No Limit)
Comparison for secondary parameter	ON	---	-

The display format and comparison format are not initialized.

■ **Setting the upper/lower limit value of comparator**

To sort the parts, set the upper/lower limit values of primary/secondary parameters.

Select the LIMIT with the comparator setting menu, and the comparator upper/lower limit value setting menu (shown below) is displayed.

**Examples of primary parameters (C):**

When the comparison format is either ABS or DEV while the cursor is at either upper or lower limit:

<u>Bin</u>	<u>Enable/ disable</u>	<u>Lower limit value</u>	<u>Upper limit value</u>	
<BIN1	ON	Lo:+1.23456 $\mu$ F	Hi:+1.23456 $\mu$ F>	Current setting
$\pm(0.0000p$ to $999999M)$				Range of settable values

**Examples of secondary parameters (D):**

When the cursor is at either lower or upper limit:

<u>Bin</u>	<u>Enable/ disable</u>	<u>Lower limit value</u>	<u>Upper limit value</u>	
< Sec	OFF	Lo:+10.0000 $\mu$	Hi:+100.000m >	Current setting
$\pm(0.0000p$ to $999999M)$				Range of settable values

Move the cursor to the point of parameter you need to set (mentioned later) and set the value.

The unit depends on each parameter.

Perform the EXIT operation to return to one-previous menu.

■ **Sorting DUTs into bins by the measured values of primary parameter**

To sort DUTs into plural bins, set the upper/lower limit values for each bin for sorting. The DUT is sorted in order from the smaller number of bin. Therefore, if the range of each bin is overlapped, the DUT is sorted into the bin of the smallest number. If the DUT does not fall in any bin range, it is sorted as "OUT OF BINS".

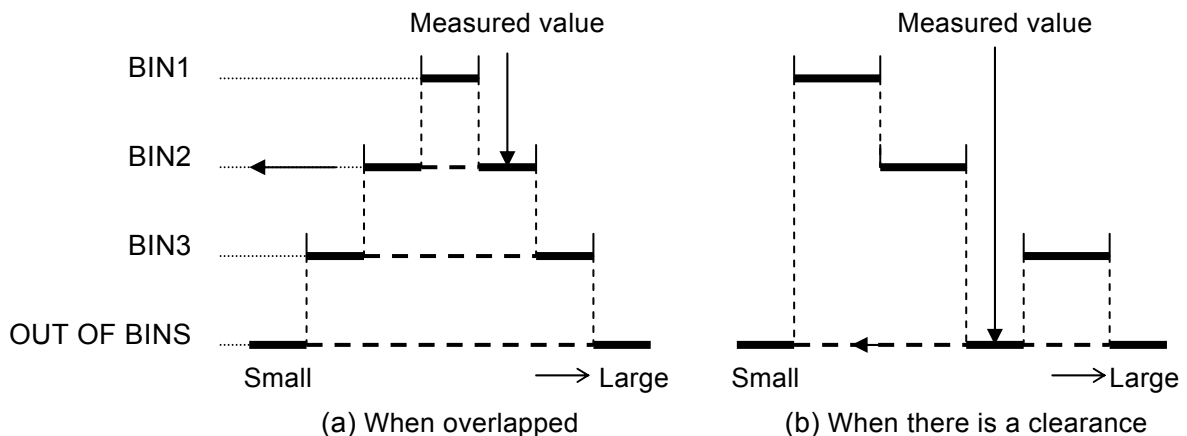

**Figure 4-2 Range setting and comparison when sorting into bins**

■ **Moving the cursor in the comparator upper/lower limit value setting menu**

The cursor is placed at the point of parameter to be set in comparator upper/lower limit value setting menu. The initial cursor position is at lower limit value of BIN1.

The cursor can be moved by pressing the **[BS]** | **[PREV]** or **[EXP]** | **[NEXT]** key. It moves not only between enable and disable of range comparison or between lower and upper limit values but more the between Bins or between primary parameter and secondary parameter. Press the **[EXP]** | **[NEXT]** key the cursor to be moved as below.

- (Secondary parameter upper limit) → (BIN1 enabled → lower limit → upper limit)
- (BIN2 enabled → upper limit → lower limit)
- . . .
- (BIN14 enabled → upper limit → lower limit)
- (Secondary parameter enabled → lower limit → upper limit) → (BIN1 enabled)

Pressing the **[BS]** | **[PREV]** key causes the cursor to be moved in the reversed order.

**[SHIFT]** + **[Pri/Sec]**

With the comparator upper/lower limit value setting menu, pressing the **[SHIFT]** + **[Pri/Sec]** keys causes the cursor to be moved between primary and secondary parameter. When switched from primary parameter (BIN) into secondary parameter, the cursor moves to the lower limit value of secondary parameter.

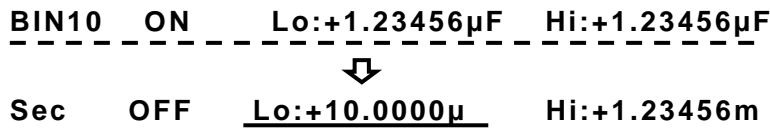

When switched from secondary parameter into primary parameter (BIN), the cursor moves to the lower limit value of BIN1.

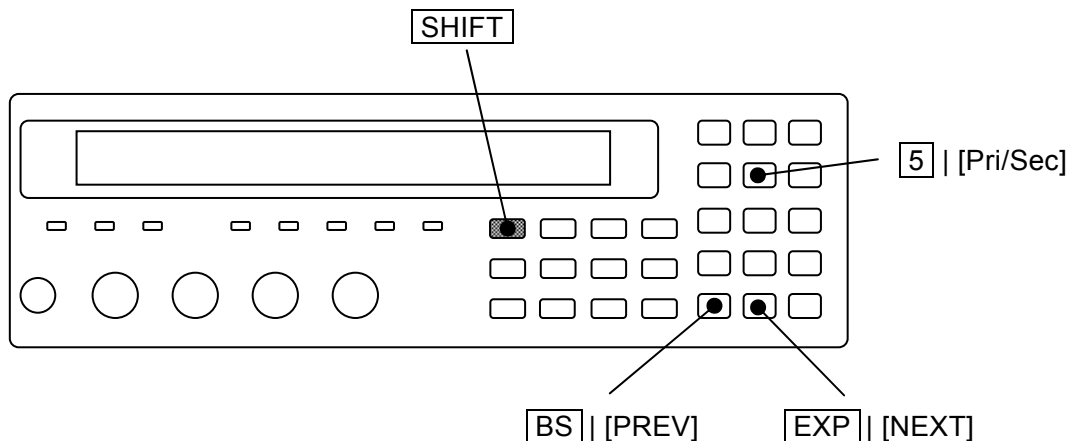
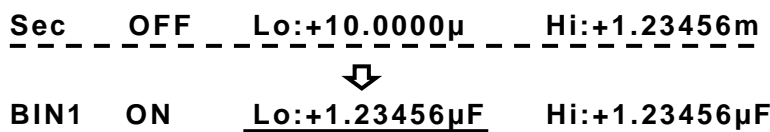

■ **Enabling/disabling the range comparison**

To make comparison using the comparator, set not only the upper/lower limit value but also “ON or OFF” for the comparison.

If the cursor is at the position of ON/OFF, it is able to set “ON or OFF” for the comparison of primary parameter’s Bin or secondary parameter where the cursor is placed.

**Examples of range comparison:** when the cursor is at ON/OFF position

<b>&lt;BIN11 OFF Lo:+1.23456μF Hi:+1.23456μF&gt;</b> <b>0)OFF 1)ON</b>	Current setting Options
---	----------------------------

ON Enables the range comparison for one set of upper/lower limit values

OFF Disables the range comparison for one set of upper/lower limit values

When the comparison of secondary parameter is disabled, the comparison for secondary parameter is not conducted but only the comparison for each Bin of primary parameter can be done (S-LO/S-IN/S-HI and S-NG are not output).

When “OFF” is set for specific Bin of primary parameter, the comparison for LO/IN/HI for that Bin is not conducted and the DUT is not sorted into that Bin. When such setting is made that the comparison for all Bins (1 to 14) of primary parameter is not conducted, the DUT is always sorted into “OUT OF BINS”.

Note that, even if range comparison is set to “Enable(Valid)”, it cannot be sorted for the given Bin in case of lower limit value  $\geq$  upper limit value.

Substantially the comparison for upper/lower limit value is not conducted.

■ **Disabling only either side of lower or upper limit**

**SHIFT** + **[ NO LIMIT ]**

With the comparator upper/lower limit setting menu, pressing the **SHIFT** + **[NO LIMIT]** keys causes the comparison of the lower or upper limit value on cursor to be disabled and the comparison is not conducted.

<b>&lt;BIN2 ON Lo:+1.23456μF Hi: No limit&gt;</b>
---

Once both of lower and upper limit values for the Bin (primary parameter) are disabled, it becomes the same state as is the case when the range comparison of Bin is disabled.

Once both of lower and upper limit values for the secondary parameter are disabled, it becomes the same state as is the case when the range comparison of secondary parameter is disabled.

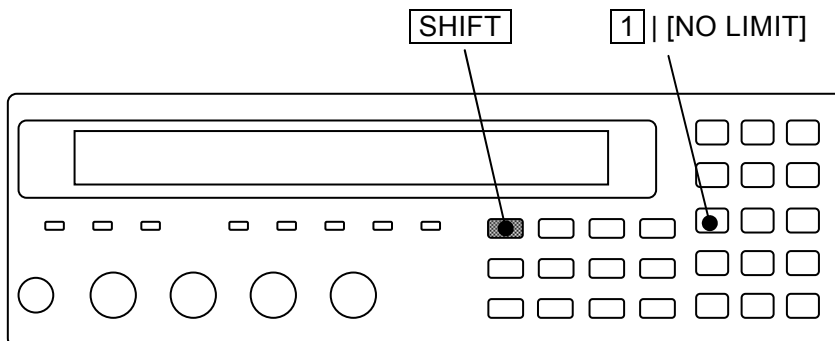

### ■ Sounding the beep sound depending on the comparator result

It is able to sound the beep sound according to the comparator result.

The beep sound can be set in the system setting menu.

#### **SHIFT** + [ **SYSTEM** ]

Press the **SHIFT** + [SYSTEM] keys to display the system setting menu.

<b>SYSTEM setting</b>		
<b>0)INTERFACE</b>	<b>1)BEEPER</b>	<b>&gt;NEXT</b>
<b>2)INITIALIZE ALL</b>		<b>3)SELF TEST</b>
		<b>&lt; &gt;</b>
<b>4)VERSION</b>		<b>&lt;PREV</b>

Options (first page)

Options (second page)

Options (third page)

Press the **1** key to select the BEEPER, and the beeper setting menu is displayed.

<b>BEEPER:OFF</b>	Current setting
<b>0)OFF</b>	<b>1)FAIL</b>
<b>2)PASS</b>	Options

**OFF** Disables the beeper (Beep sound stops).

**FAIL** Allows the beep to sound when the comparator result is failed (other than BIN1 to BIN14)

**PASS** Allows the beep to sound when the comparator result is passed (BIN1 to BIN14)

In case that the limit comparison is enabled: it should be regarded as “PASS” when comparison result is IN or be regarded as “FAIL” in other cases.

After setting, the results are displayed for a short time and return to one-previous menu.

Perform the EXIT operation to return to one-previous menu.

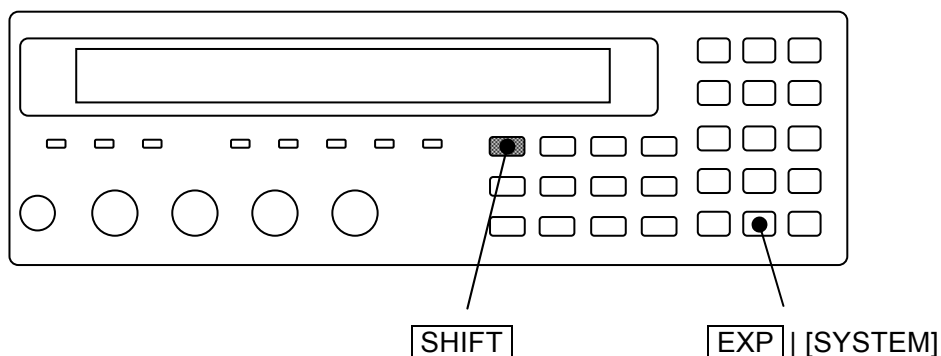



## 4.4 Connecting to the Part handler (Handler Interface)

For the **ZM2372**, the comparator result can be output into the handler interface of rear panel. Connecting to the part handler allows auto part sorting system to be configured. The **ZM2371** does not have the handler interface.

**Table 4-2 Handler interface signal layout**

Pin No.	I/O	Signal name	Pin No.	I/O	Signal name
1	IN	TRIG, /TRIG	26	IN	/RCL0
2	IN	/RCL1	27	IN	/RCL2
3	IN	/RCL3	28	IN	/RCL4
4	IN	(reserved)	29	IN	(reserved)
5	IN	/RCL-VALID	30	OUT	/BIN1, <b>/P-HI</b>
6	OUT	/BIN2, <b>/P-IN</b>	31	OUT	/BIN3, <b>/P-LO</b>
7	OUT	/BIN4, <b>/S-HI</b>	32	OUT	/BIN5, <b>/S-IN</b>
8	OUT	/BIN6, <b>/S-LO</b>	33	OUT	/BIN7, <b>/IN</b>
9	OUT	/BIN8	34	OUT	/BIN9
10	OUT	(/BIN10)	35	OUT	(/BIN11)
11	OUT	(/BIN12), /NC	36	OUT	(/BIN13), /PHI
12	OUT	(/BIN14), /PLO	37	OUT	/OUT OF BINS
13	OUT	/INDEX	38	OUT	/EOM
14	OUT	/ERR	39	OUT	/S-NG
15	IN	/KEY_LOCK	40	- - -	(reserved)
16 to 20	IN	EXT DCV	41 to 45	OUT	INT DCV
21 to 25	IN	EXT COM	46 to 50	OUT	INT COM

- The “/” at the top of signal name shows the negative logic where “low level” specifies “1”.
- The “( )” shows the signal when number of Bin is expanded (/NC, /PLO and /PHI are not output).

For the expansion of Bin number . . .  **Expanding the bin number of primary parameter**.

- The **reversed character** shows the output signal in case of limit comparison. /BIN1 to /BIN14, /PHI and /PLO are not output in case of limit comparison.

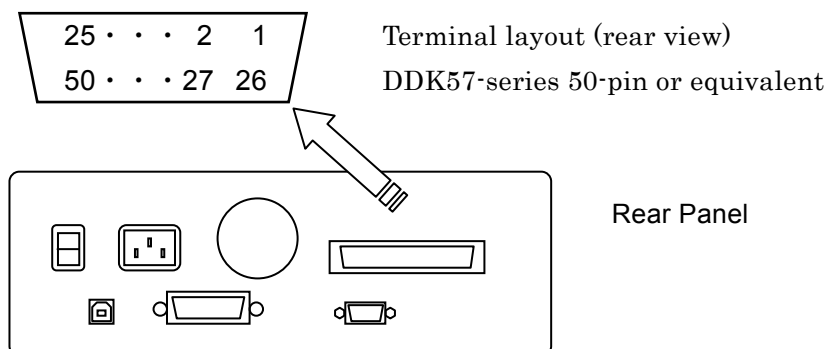

Table 4-3 Functions of handler interface signal

Pin No.	I/O	Signal name	Descriptions
1	IN	TRIG, /TRIG	External trigger signal (rising edge) Can be switched into falling edge
26	IN	/RCL0 (low order)	Setting/correction value memory selection signal (Binary) When /RCL-VALID is 1 (low level) and trigger source is external (Ext): once the external trigger signal stated above is received, the memory specified by this signal allows the setting and correction value to be recalled and measurement is conducted under those conditions. Recall of memory number out of the range may result in an error.
2	IN	/RCL1	
27	IN	/RCL2	
3	IN	/RCL3	
28	IN	/RCL4 (high order)	
4	IN	(reserved)	Not in use Do not connect anything.
29	IN	(reserved)	Not in use Do not connect anything.
5	IN	/RCL-VALID	It shows that the memory selection signal is valid.
30	OUT	/BIN1, /P-HI	/BIN1 to /BIN14: Bin sorting signal /BIN10 to /BIN14 are output when Bin expansion is enabled (besides the limit comparison is disabled). /NC: Contact failure /PHI: primary parameter upper limit over signal /PLO: primary parameter lower limit under signal /NC, /PHI and /PLO are output only when Bin expansion is disabled (initial value) /P-HI, /P-IN, /P-LO : Primary parameter comparison signal /S-HI, /S-IN, /S-LO : Secondary parameter comparison signal /IN: Primary/secondary total pass comparison signal When limit comparison is enabled, Bin sorting signals of "/BIN1 to /BIN14" are output in place of /PHI and /PLO. Also for the limit comparison, /NC, /ERR, /OUT OF BINS (signal where /IN is reversed) and /S-NG (/S-HI or /S-LO) are output.
	OUT	/BIN2, /P-IN	
31	OUT	/BIN3, /P-LO	
7	OUT	/BIN4, /S-HI	
32	OUT	/BIN5, /S-IN	
8	OUT	/BIN6, /S-LO	
33	OUT	/BIN7, /IN	
9	OUT	/BIN8	
34	OUT	/BIN9	
10	OUT	--- /BIN10	
35	OUT	--- /BIN11	
11	OUT	/NC, /BIN12	
36	OUT	/PHI, /BIN13	
12	OUT	/PLO, /BIN14	
37	OUT	/OUT OF BINS	Fail comparison signal
13	OUT	/INDEX	Signal acquisition end signal. Once it becomes "1" (low level), it is possible to switch into next DUT.
38	OUT	/EOM	End of measurement signal. Once it becomes "1"(low level), the comparator result become valid and it is possible to read.
14	OUT	/ERR	Measurement error signal It shows excessive voltage or current, contact failure(NC), ALC failure or other errors.
39	OUT	/S-NG	Secondary parameter fail comparison signal
15	IN	/KEY_LOCK	Key lock signal. Once it becomes "1"(low level), it disables all key-operations of panel. It cannot be canceled through the panel or remote control.
40	---	(reserved)	Not in use. Do not connect anything.
16 to 20	IN	EXT DCV	External DC power input (+5V to +24V)
21 to 25	IN	EXT COM	External DC power input(common) Each signal of handler interface is isolated from the case and operates with the external DC power.
41 to 45	OUT	INT DCV	Internal DC power output (+5V)
46 to 50	OUT	INT COM	Internal DC power output (common) To operate the Handler interface with the Internal DC power source, make connection between EXT COM and INT COM and also between EXT DCV and INT DCV. There is no isolation with the case.

- Regardless of the regulations stated in the table, /BIN1 to /BIN14, /OUT OF BINS, /S-NG, /PLO and /PHI are not output when /ERR is outputted. In case of limit comparison, it is justified as “/P-HI and /S-HI” when /ERR is outputted.

■ **Electrical characteristics of handler interface**

External power	Rated voltage +5V to +24V, Operating range +4.5V to +26.4V Max power consumption 40mA(5V) / 100mA(12V) / 200mA(24V)
Internal power	+5V (typ), 70mA max, Common is grounded to the case
Isolation	42Vpk (Each signal, Common) vs. case When Internal DC power output terminal is connected with External DC power input, isolation is not provided.
Output characteristics	
Output low level	0.5V max (Power voltage 5V, Sink current 6mA) 1.2 V max (Power voltage 12V, Sink current 8mA) 2.4 V max (Power voltage 24V, Sink current 10mA)
Output high level	5 to 24V (Depend on power voltage)
Input characteristics (Trigger excluded)	
Input low level	(Power voltage - 4.1V) max
Input high level	(Power voltage - 1.1V) min
Input characteristics (Trigger)	
Input low level	(Power voltage × 0.3) max
Input high level	(Power voltage × 0.7) min

**⚠ WARNING**

**Do not apply the voltage more than 42Vpk onto the signal of handler interface or the space between common and case. Otherwise, you may feel electrical shock or the ZM2372 may be damaged.**

■ **Handler interface I/O equivalent circuit**

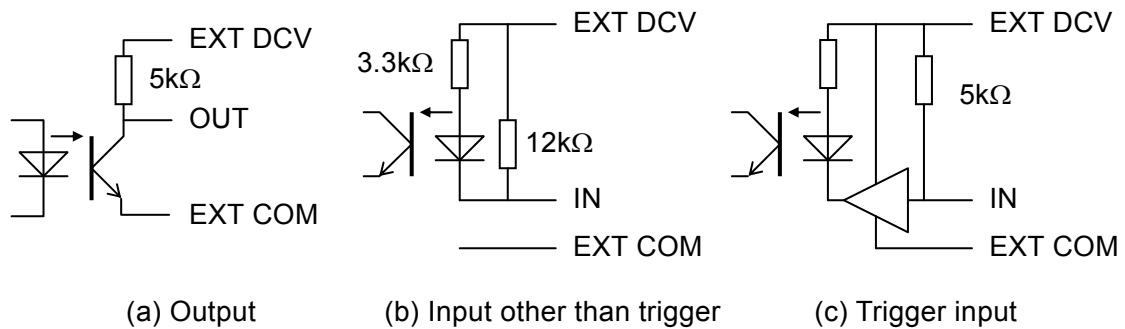

**Figure 4-3 Equivalent circuit of handler interface**

■ Handler interface operation timing

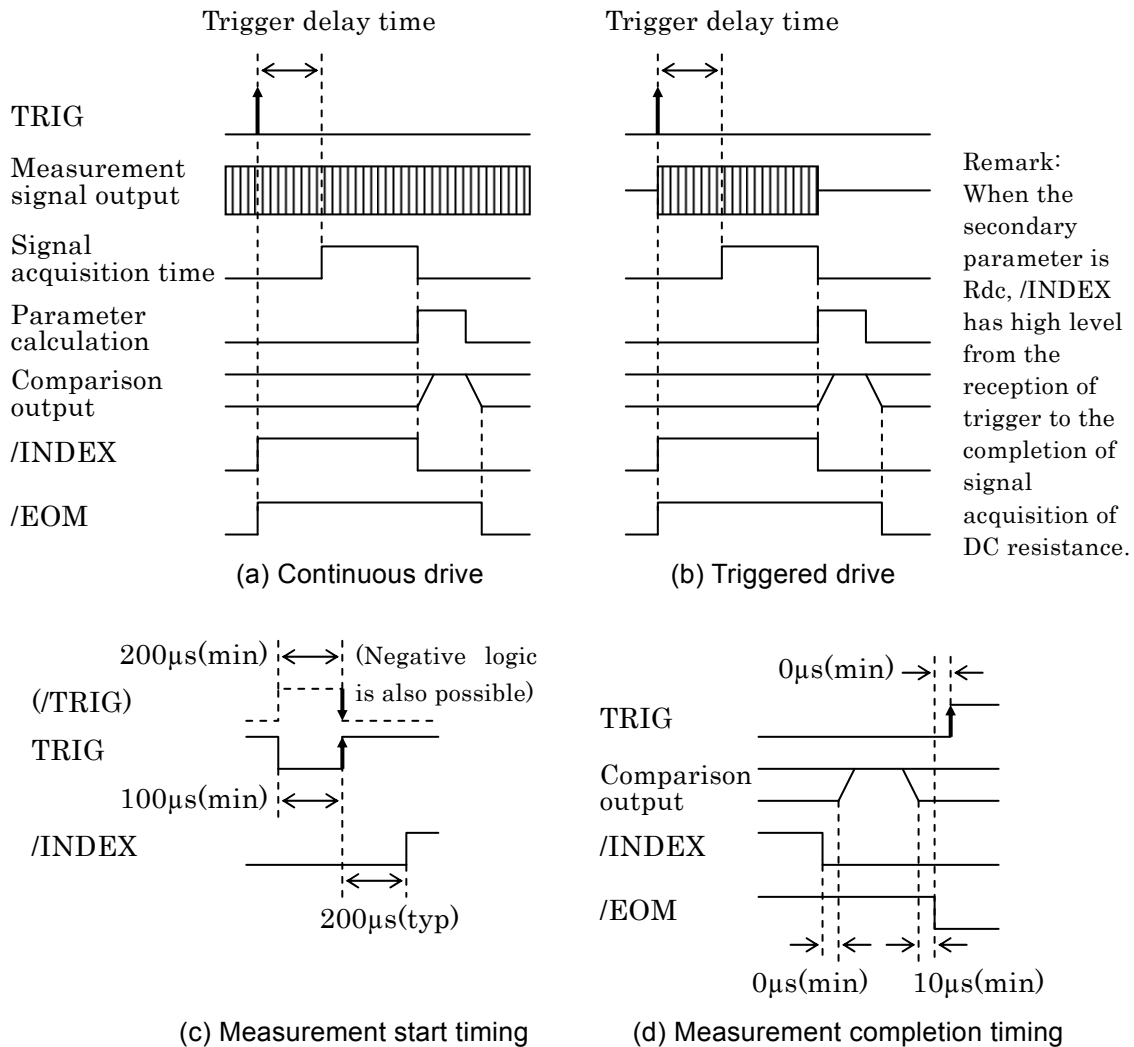

Figure 4-4 Handler interface operation timing

■ Cable length of Handler interface

It should be preferably within 5m, or should not exceed 15m maximum. Use the shielded cable to avoid noise emission and contamination.

■ Relation between enabled/disabled of comparator and handler interface signal

When handler is disabled, handler interface output is as below:

- Comparison signal (Terminal corresponding to /BIN1 to /BIN14, /OUT OF BINS, /S-NG, /ERR) fixed to high level (not output)
- /EOM, /INDEX  
Fixed to low level (always output)

The output immediately after power turned on is the same as above as well. Also, the same state is established by the initializing operation with the initialize menu or system setting menu or by the \*RST command.

Regardless of enabled/disabled of comparator, input of handler interface is always enabled.

- Input: TRIG, /KEY\_LOCK, /RCL0 to /RCL4, /RCL-VALID

■ Adjusting the handler interface functions (Only for ZM2372, unavailable in ZM2371)

**SHIFT** + [ **HANDLER** ]

Press the **SHIFT** + [ **HANDLER** ] keys to display the handler interface setting menu.

<b>Handler</b>			
<b>0)OUT OF BINS</b>	<b>1)BIN10-14</b>	<b>&gt;NEXT</b>	Options (first page)
<b>2)TRIG Polarity</b>	<b>3)RCL</b>	<b>&lt; &gt;</b>	Options (second page)
<b>4)HANDLER CHECK</b>		<b>&lt;PREV</b>	Options (third page)

- OUT OF BINS            OUT OF BINS Output setting menu
- BIN10-14             Bin extension menu
- TRIG Polarity        Polarity setting menu of trigger input signal
- RCL                    Setting menu of memory selection signal
- HANDLER CHECK      Handler interface check menu

Use each function after selecting the sub menu.

Perform the EXIT operation without selecting anything and the measurement screen will come back.

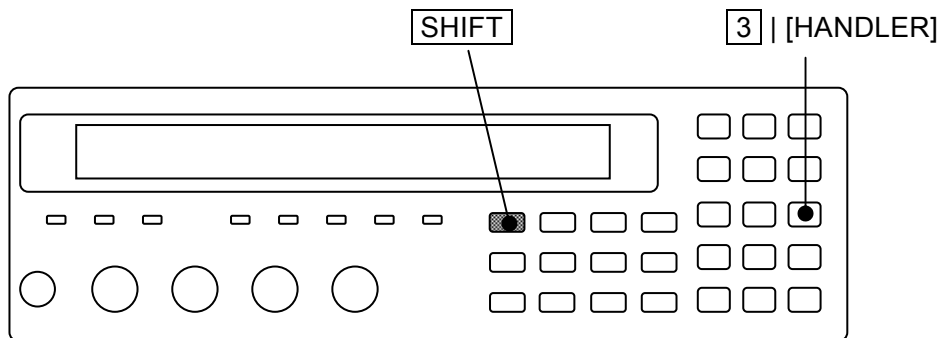

■ Setting "OUT OF BINS" output in case of S-NG

You can select whether or not S-NG (outside the range of secondary parameter) should be regarded as auxiliary BIN (AUX BIN) independent from OUT OF BINS. It is the same for limit comparison as well.

"OUT OF BINS" output setting menu is as follows:

<b>OUT OF BINS: Include S-NG</b>	Current setting
<b>0)Include 1)Exclude</b>	Options

- Include**    In case of S-NG, "OUT OF BINS" signal is outputted coincidentally (Initial value). "Outside the range of primary parameter" and "Outside the range of secondary parameter" are classified as "OUT OF BINS" all together.
- Exclude**    In case of S-NG, "OUT OF BINS" signal is not outputted. The DUT whose primary parameter is within the range but secondary parameter is outside the range should be classified as the independent AUX Bin (S-NG) instead of "OUT OF BINS".

Select either by the numeric key.

If a setting is made or the EXIT operation is performed, one-previous menu comes back.

### ■ Extending the Bin number of primary parameter

The initial value of class number of primary parameter is “9”, but can be expanded to “14”.

“Bin extension setting menu is as follows:

<b>BIN10-14 Output: OFF</b>	Current setting
<b>0)OFF=PHI,PLO 1)ON=BIN10-14</b>	Options

**OFF** The signals of “BIN10 to BIN14” are not outputted (max 9-class).  
When the primary parameter is outside the range, PHI or PLO signal is outputted.

**ON** The signals of “BIN10 to BIN14” are outputted (max 14-class).  
Even if the primary parameter is outside the range, both PHI and PLO signal are not outputted.

If a setting is made or the EXIT operation is performed, one-previous menu comes back.

In case that the signals of BIN10 to BIN14 are not outputted, even if setting is made so that sorting for those BINs will be conducted, sorting for BIN10 to BIN14 is not conducted.

### ■ Setting the Trigger polarity

You can select which of rising edge and falling edge of trigger signal is used to start measurement.

“Polarity setting menu of trigger input signal is as follows:

<b>TRIG Polarity:Negative</b>	Current setting
<b>0)Negative 1)Positive</b>	Options

**Negative** Falling edge (H→L) of trigger signal is used to trigger.

**Positive** Rising edge (L→H) of trigger signal is used to trigger. (initial value)

If a setting is made or the EXIT operation is performed, one-previous menu comes back.

The Trigger polarity cannot be selected in Remote control.

### ■ Selecting the functions of memory selection signal

You can select the target for restoring from the setting/correction value memory by the input signal to the handler interface.

“Memory selection signal setting menu is as follows:

<b>Handler Recall Function:Setting</b>	Current setting
<b>0)Setting 1)Correction 2)Both</b>	Options

**Setting** Recalls only the setting from the specified memory (initial value)

**Correction** Recalls only the correction value from the specified memory

**Both** Recalls both setting and correction value from the specified memory.

If a setting is made or the EXIT operation is performed, one-previous menu comes back.

■ **Checking the operation of handler interface**

You can check the operation through outputting the given signal into handler interface or monitoring the input signal.

Handler interface check menu is as follows:

<b>Handler Check</b>	<b>TRIGt</b>	<b>RCLsss</b>	<b>VLDv</b>	<b>LOCKk</b>	Input signal monitor
<b>0)OFF</b>	<b>1)DOWN</b>	<b>2)UP</b>	<b>3)EOM</b>	<b>BINnn</b>	Output options

Signal name which is in dummy output

Perform the EXIT operation to return to the measurement screen.

**Input signal monitor**

Numeric values appear while the status of Input signal line is being regarded as the negative logic input.

Signal name	Display name	Status	Descriptions of status
/TRIG	TRIG	t	0: high level, 1: low level (It is regarded as negative logic regardless of the setting of trigger polarity)
/RCL0../RCL4	RCL	sss	0..127: next 7-bit is converted into decimal 3-digit before displaying From high order, Pin 29, Pin 4, /RCL4 (MSB), /RCL0 (LSB)
/RCL-VALID	VLD	v	0: High level, 1: Low level
/KEY_LOCK	LOCK	k	0: High level, 1: Low level

**Dummy output signal**

Select the each option with the numeric key, the following operation starts:

The signal name (abbreviation) being output appears on the lower right of display.

0)OFF Allows all outputs to turn off (high level)

When handler interface checking menu appears, this status comes out.

1)DOWN Allows output signal to decrease by one smaller in Bin number (see below)

2)UP Allows output signal to increase by one larger in Bin number (see below)

Example of UP operation (DOWN operation allows reversed movement)

(OFF) → /BIN1 → /BIN2 → · · · /BIN14 → /OUT OF BINS → /S-NG → /INDEX → /EOM → /ERR → (OFF)

Only one of output signals is ON (low level), but others are OFF (high level).

However, all output signals are OFF at (OFF) position.

3)EOM /INDEX and /EOM are operated as is the case with the measurement when

trigger is applied but it may not affect on other signals. The change of signals with the times is fixed as below.

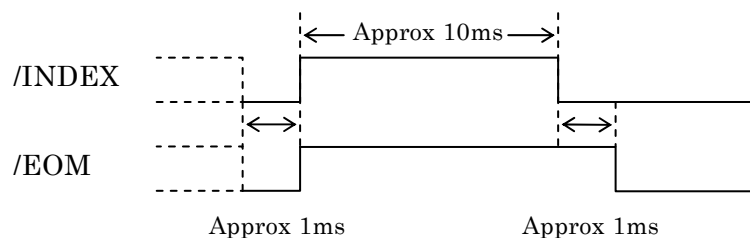

**Figure 4-5 Dummy output timing**

## 4.5 Changing the Contents Displayed on the Second Line of Measurement Screen (Auxiliary Display)

Normally the specified setting information is displayed on the second line (Auxiliary display) of measurement screen. It is possible to change those contents into other setting information or voltage/current monitor values.

### AUX DISP

Press the **AUX DISP** key to display the auxiliary display selection setting menu.

<b>Aux Display:Status</b>	Current setting
<b>0)Status 1)Pri-Limit 2)Sec-Limit &gt;NEXT</b>	Options (first page)
<b>3)Pri-Sec REF 4)I-V monitor &lt;PREV</b>	Options (second page)

Status	Measurement condition (initial value)	<b>A100kΩ FAST100 Int OpShLd1m</b> . . .	ex.
Pri- Limit	Lower and upper limit values of primary parameter (specified Bin)	<b>10:+970.000nF to +1.03000μF</b> . . .	ex.
	Specify the Bin number in the Bin number input menu.		
Sec-Limit	Lower and upper limit values of secondary parameter	<b>Sec+0.00000 to +12.0000m</b> . . .	ex.
	When comparator and limit comparison are disabled that Pri-Limit and Sec-Limit are being selected, the status appears.		
Pri-Sec REF	Reference values for deviation display of both primary and secondary parameter	<b>REF:P+1.00000μF S+100.000m</b> . . .	ex.
	When the deviation display and deviation comparison are disabled that Pri-Sec REF is being selected, the status appears.		
I-V monitor	Current monitor value and voltage monitor value	<b>Im:+123.456mA Vm:+1002.34mV</b> . . .	ex.

If a setting is made or the EXIT operation is performed, the measurement screen comes back.

Select the parameter you need to display by the numeric key.

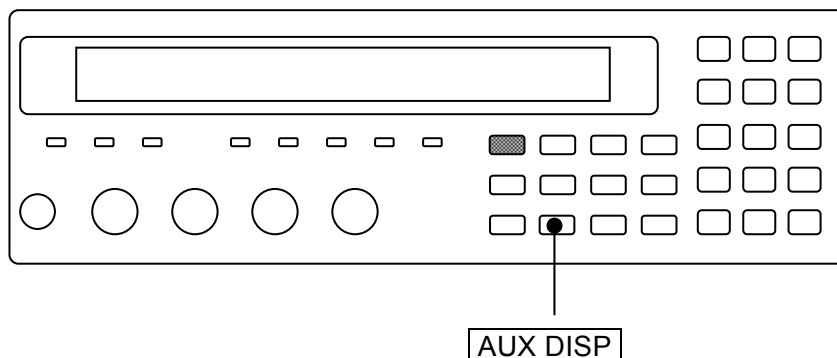



#### 4.5 Changing the Contents Displayed on the Second Line of Measurement Screen (Auxiliary Display)

---

Select the Pri-Limit, and the Bin number input menu is display. Set the Bin number whose upper/lower limit value you need to display.

**BIN No:14**

Current setting

**1 to 14**

Range of settable values

Perform the EXIT operation to return to one-previous menu.

After setting, measurement screen comes back.

## 4.6 Saving/Recalling the Setting and Correction Value into the Memory

ZM2371 / ZM2372 enable save-/recalling the setting and correction value up to 32-set.

### ■ Saving the setting and correction value into the memory

#### SHIFT + [ SAVE ]

Press the [SHIFT] + [SAVE] keys to display the setting/correction value memory saving setting menu.

**SAVE : Setting**  
**0 to 31 .)Correction -)Both**

Current settable  
range to be saved

Enter the target to be saved and the memory number, and press the [ENTR] key, to carry out saving (overwriting). After saving, the following confirmation message appears for a short time and measurement screen comes back.

**Save -> 9**

### ■ Recalling the setting and correction value saved in memory

#### SHIFT + [ RECALL ]

Press the [SHIFT] + [RECALL] keys to display the setting/correction value memory recall setting menu.

**RECALL : Setting**  
**0 to 31 .)Correction -)Both**

Current settable  
range to be saved

Enter the target to be recalled and the memory number, and press the [ENTR] key, to carry out recalling. After recalling, the following confirmation message appears for a short time and measurement screen comes back.

**Recall <- 9**

It is disabled to recall the setting and correction value memory, which are not being saved.

**Recall <- EMPTY**

The target for Save/Recall is **Setting** (only Setting) at first. Therefore, if you enter the memory number and press the [ENTR] key, only the setting can be saved or recalled. The target can be temporarily changed into **Correction** (only correction value) or **Both** (both ways) by entering the decimal point [.] or negative sign [-].

**RECALL : Correction**

Only correction value

Perform EXIT operation without performing saving or calling, and the measurement screen will come back.

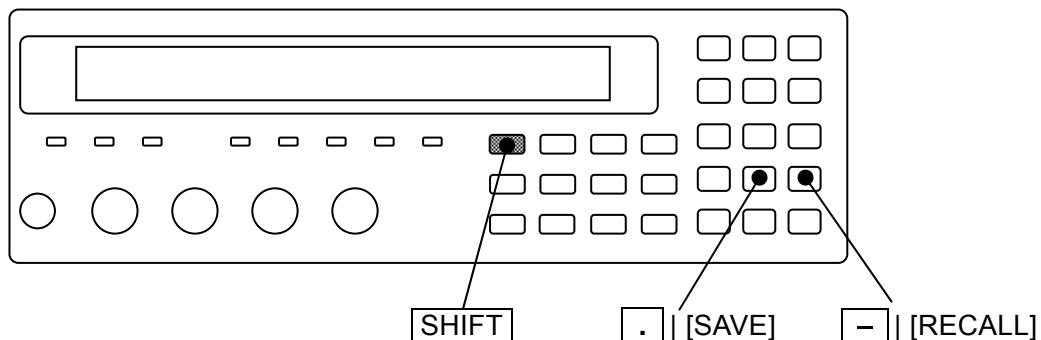

**Examples of specifying**

Setting (Setting only)	ex.) <b>2 1</b>	Input the numeric value only.
Correction (Correction value only)	ex.) <b>. 2 1</b>	Input the decimal point before numeric value.
Both (Both setting and correction value)	ex.) <b>- 2 1</b>	Input the negative sign before numeric value.

The target for Save/Recall can be changed by entering the decimal point  or negative sign  before defining by the  key. For example, if the  key is pressed after the target is changed into correction by pressing the  key, the target can be changed into both. Meanwhile, when the target is correction, the target can return to the setting by additionally pressing the  key

After performing Save/ Recall, the target for Save/ Recall turns back to the setting.

**■ Initializing the setting/correction value memory**

It is impossible to initialize the contents of setting/correction value memory with the pressing the  +  ,  keys.

It is possible to initialize the setting/correction value memory by the operation of “Fully initialization” in system setting menu. However, the setting of interface is also initialized.

For the “Fully initialization”  **“4.10 Initializing of All Settings”**.

## 4.7 Setting the Contact Check

**ZM2372** has the 4-terminal contact checking function that can check the contact condition of all the terminals  $H_{CUR}$ ,  $H_{POT}$ ,  $L_{POT}$  and  $L_{CUR}$  with the DUT. This function is not available in **ZM2371**.

The contact checking is disabled under the initial state. To avoid a wrong measurement due to the contact failure, set the contact check to "enabled".

### **SHIFT** + [ **CONTACT** ]

Press the **SHIFT** + [CONTACT] keys to display the contact check setting menu.

<b>Contact check:OFF</b>	Current setting
<b>0)OFF 1)ON 2)Real time</b>	Options

OFF	Disables the contact check (initial value)
ON	Enables the contact check
	Detects the contact failure immediately before measuring the impedance
Real time	Display the real time check setting menu
	The contact failure of $H_{CUR}$ terminal can be detected during signal acquisition for impedance measurement.

If a setting is made or the EXIT operation is performed, the measurement screen comes back.

After enabling the contact check, triggered drive can be automatically set to enabled. When the contact check is enabled, triggered drive cannot be set to disable, resulting in an error.

### **CONTACT CHECK lamp**

When the contact check is enabled, CONTACT CHECK lamp lights up.

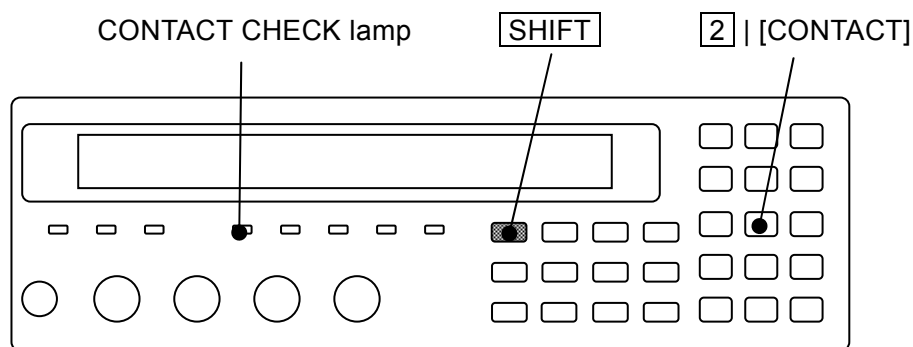

### ■ Operational outline of 4-terminal contact check

For **ZM2372**, before normal measurement, it is possible to check the contact status of each terminal by monitoring the resistance value between both terminals after applying the small test signal onto between  $H_{CUR}$ - $H_{POT}$  and also between  $L_{CUR}$ - $L_{POT}$  while the contact check is enabled. Once the contact failure is detected, **ZM2372** allows the measured value “NC” to appear without performing normal measurement.

The additional time necessary for 4-terminal contact check is approx 4ms.

The test signal of contact check becomes OFF during normal impedance measurement.

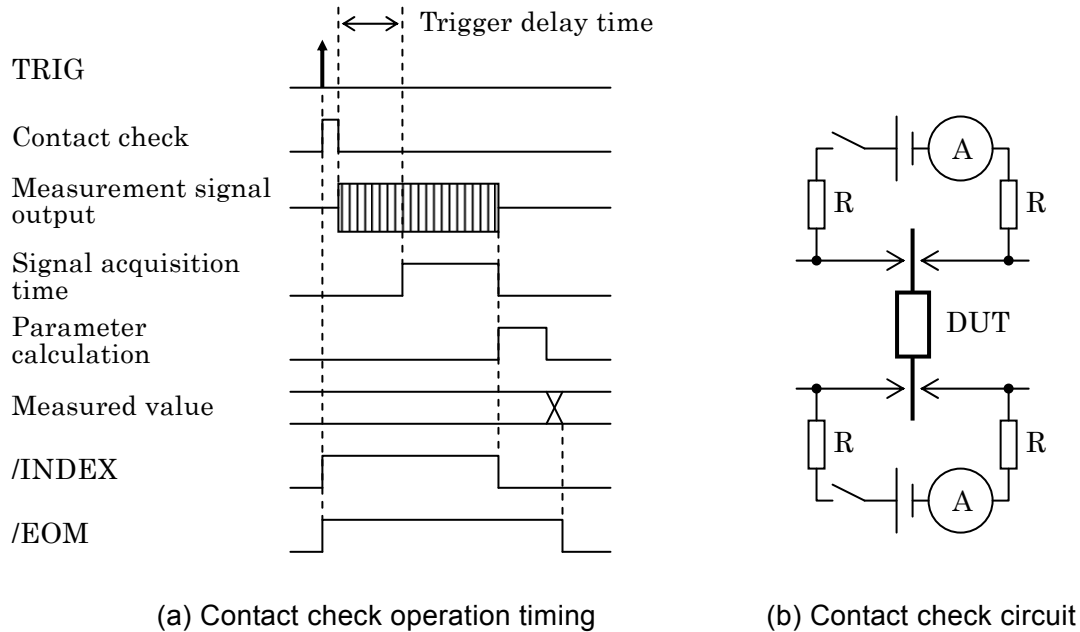

**Figure 4-6 4-terminal contact check**

If the contact is normal, unnecessary signal can not be applied in the DUT during contact check. In contact failure, it is possible that up to 3V and 50 $\mu$ A signal can be applied in the DUT. For the polarity of test signal to be applied in the DUT during contact failure,  $H_{CUR}$  and  $H_{POT}$  side becomes plus against  $L_{CUR}$  and  $L_{POT}$  side.

### ■ Criterion for contact failure

For **ZM2372**, in 4-terminal contact check, if the resistance value between  $H_{CUR}$ - $H_{POT}$  terminals or between  $L_{CUR}$ - $L_{POT}$  terminals exceeds 200 $\Omega$ , it should be judged as contact failure.

---

**■ Restrictions for 4-terminal contact check****• When measuring the resistance or inductor**

If the DC resistance of DUT is low, it is afraid that the contact failure of H<sub>CUR</sub> terminal can not be detected.

When measuring the DUT of 250Ω or less in DC resistance, set the “Real time check” to enabled (initial value) so as to detect the contact failure of H<sub>CUR</sub> terminal.

**• When measuring the capacitance**

If the capacitance of DUT is large, it is afraid that the contact failure of H<sub>CUR</sub> terminal can not be detected.

When measuring the DUT of 15μF or more in capacitance, set the “Real time check” to enabled (initial value) so as to detect the contact failure of H<sub>CUR</sub> terminal.

However, even the real time check does not enable the contact failure of H<sub>CUR</sub> terminal to be detected in case of measurement frequency < 0.1Hz.(It is possible to detect in case of approx 100kΩ or less in impedance)

If the insulation resistance is extremely low, it is afraid that the contact failure of H<sub>CUR</sub> terminal can not be detected.

When measuring the DUT of 250Ω or less in insulation resistance, set the “Real time check” to enabled so as to detect the contact failure of H<sub>CUR</sub> terminal.

In case that the leak current is large when DC bias voltage is applied, it is afraid that the contact failure of H<sub>CUR</sub> terminal can not be detected. If the leak current exceeds 15μA, set the “Real time check” to enabled so as to detect the contact failure of H<sub>CUR</sub> terminal.

The contact check does not run normally during charge-/discharging of DUT by the DC bias. You should trigger only after the bias voltage is stabilized after finishing charge-/discharging.

### ■ Contact check during signal acquisition

Once the real time check is set to enabled, it is possible to detect only the contact failure of H<sub>CUR</sub> terminal even during signal acquisition. This function may not affect on impedance measurement besides there is no additional time incurred.

Select the Real time with the contact check setting menu, and the following real time check setting menu is displayed.

**Real time check:OFF**

**0)OFF 1)ON**

Current setting

Options

OFF Disables the real time check

ON Enables the real time check (initial value)

Perform the EXIT operation to return to one-previous menu.

After setting, the results appear for a short time and return to one-previous menu.

Only when setting both real time check and contact check to enabled, the real time check will run.

### ■ Operational outline of real time check

The real time check of **ZM2372** allows checking the relation between drive signal and measured values of voltage, current and impedance of DUT when obtaining the measured results of AC impedance. If the above relation is extremely different from the one in normal operation, it is regarded as contact failure.

Also when measurement signal gets an error due to the damaged drive signal source (H<sub>CUR</sub>), it is afraid to be regarded as the contact failure. Always use the voltage/current monitor of auxiliary display to check the voltage and current when great fluctuation in measured values, which suggests an abnormal operation, is generated.

### ■ Restrictions for real time check

Only when the impedance of DUT is less than approx 100k $\Omega$ , the real time check enables the contact failure of H<sub>CUR</sub> terminal to be detected.

If the total of H<sub>CUR</sub> connection cable impedance and normal contact resistance exceeds the following approximate permissible value, it is possible to be justified as the contact failure in real time check.

- Permissible value=20 $\Omega$  in case of 100 $\Omega$  in output impedance
- Permissible value=10 $\Omega$  in case of 25 $\Omega$  in output impedance
- Permissible value= 5 $\Omega$  in case of 5 $\Omega$  in output impedance

When frequently or always justified as contact failure due to the large impedance of connection cable despite that the contact is normal, set the real time check to disabled.

It is impossible to detect the contact failure of H<sub>POT</sub>, L<sub>POT</sub> and L<sub>CUR</sub> terminal in real time check. The real time check is used for the measurement of AC impedance but not applied for the measurement of DC resistance R<sub>dc</sub>.

## 4.8 Using the DC Bias

**ZM2371 / ZM2372** allow the measurement where DC bias voltage up to 2.5V is applied on polar capacitance, PN junction of semiconductor and etc. To apply the DC bias voltage, set the bias voltage and turn on the DC bias.

### BIAS

Press the **BIAS** key to display the DC bias setting menu.

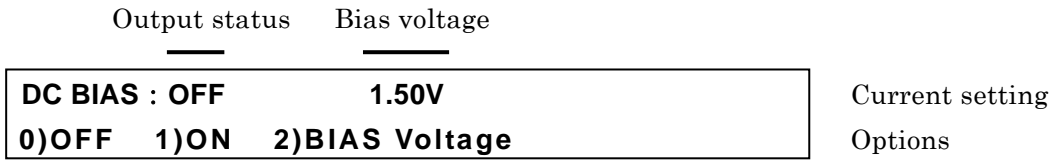

- OFF Turns off (0V) the DC bias output  
The set value of DC bias voltage is retained inside.
- ON Turns on (preset voltage) the DC bias output  
However, it is unable to turn on when triggered drive is enabled.
- BIAS Voltage Display the DC bias voltage input menu

Press the ON/OFF or perform EXIT operation, and the measurement screen comes back.

BIAS Voltage DC bias voltage input menu is as follows:



It is possible to set at 0.01V in resolution. Enter the numeric value, and press the **ENTR** key.

If a setting is made or the EXIT operation is performed, one-previous comes back.

### BIAS ON lamp

The BIAS ON lamp of front panel lights up during DC bias output ON.

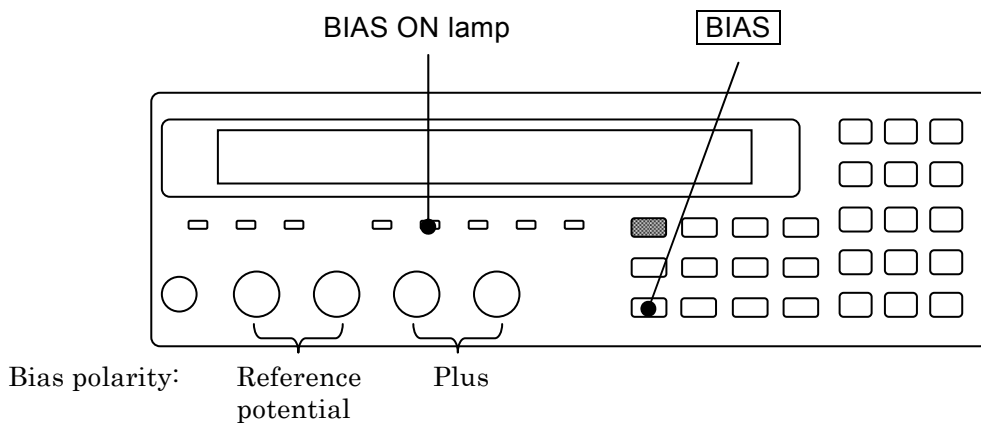

The set value of current DC Bias voltage appears on the second line of measurement screen.

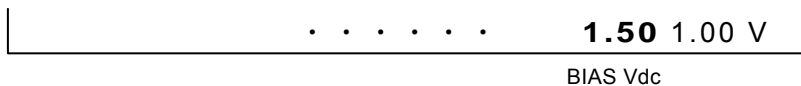



### ■ When the signal level is high

The peak voltage that can be outputted by **ZM2371 / ZM2372** is up to approx 7.07V.

It is impossible to set when the total of the peak value of AC measurement signal and DC bias voltage exceeds the above voltage. If you intend to set the measurement signal level or DC bias voltage beyond the above limit, it will be set as the permissible maximum value at that moment.

### ■ Settling time for DC bias voltage

The charge-discharging current at early stage of charge-discharging can be suppressed up to approx 1.4-time that of the max sensing current  $I_p$ [Arms] that can be absorbed by the current sensing section in each measurement range. Therefore, the settling time  $T_s$ [s], which is determined by the above current value, capacitance  $C$  (F) of DUT and change  $V_c$ [V] in Bias voltage, is needed until it can be stabilized within the limited current range.

$$T_s \cong C \times V_c / (I_p \times 1.4)$$

Max sensing current that can be absorbed by the current sensing section

☞ See “**Table 3-3 Max. current, max. voltage and output impedance in each measurement range**”.

However, from view point of absorbing amount of charge-discharging current, the  $I_p$  is:

50 $\mu$ A when the value in table is below than 50 $\mu$ A at frequency  $\leq 20$ kHz;

500 $\mu$ A when the value in table is below than 500 $\mu$ A at frequency  $\geq 20$ kHz.

Since the charge-discharging current beyond the above value runs through the protection circuit of  $L_{CUR}/L_{POT}$  terminal, it is possible that the actual settling time can be less than  $T_s$ . Under the low impedance range ( $\leq 100\Omega$ ) or from the time onward when the limited current range is achieved after charging/discharging continues in a certain level, the convergence may occur for the settling time  $T_{stl}$ [s], which is determined by the time constant, that is, the output impedance  $R_d$ [ $\Omega$ ] and capacitance  $C$ [F] of DUT.

$$T_{stl}[s] \cong 7 \times C \times R_d$$

### ■ When there is a leak current or it takes a long time for charging

When leak current is large due to the low insulation resistance of DUT or when charging current runs for a long time due to the dielectric absorbing or when it takes a long time for charging due to the large capacitance, the following symptoms may occur:

- The bias voltage goes down due to the voltage drop caused by the output impedance and DC current. It allows the signal voltage sensing section to exceed the operation range, thereby disabling the correct measurement.
- The peak of signal current exceeds the permissible range of measurement range, thereby disabling the correct measurement.
- Auto selection of measurement range does not work properly.

If the measurement range is fixed to the range where the current running through the DUT or the peak value of applied voltage can be measured even in the above cases, the impedance may be able to measure. However, it is afraid that the measurement accuracy may extremely go down while exceeding the recommended measurement range.

### ■ Applying a small DC bias current through the Inductor

If a bias current falls within a small range that the **ZM2371 / ZM2372** can supply, the impedance may be able to measure while the DC Bias current is running by fixing the measurement range to the range where “Bias current + Peak value of AC measurement current” can be measured. The Bias current can be adjusted by changing the Bias voltage. Once the measurement level or measurement frequency is changed, the measurable range is also changed.

### ■ Applying the high DC bias voltage

To apply the high bias voltage beyond 2.5V onto the DUT, external power is required. In this case, insert the capacitance in series between H<sub>CUR</sub> terminal and H<sub>POT</sub> terminal so that the AC voltage and current may not run through the LCR meter.

Set the DC bias output of **ZM2371 / ZM2372** to OFF.

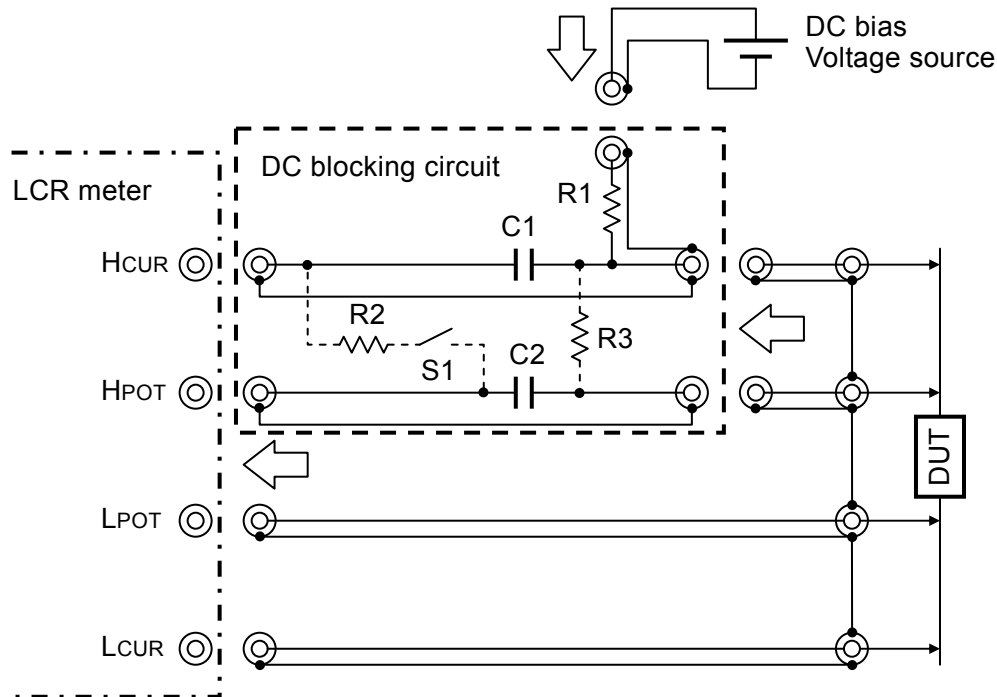

Element value: the following case shows the example of measurement taken at 100Hz or more in frequency:

C1 = 100 $\mu$ F (Bipolar electrolytic capacitor)

C2 = 20 $\mu$ F (Film capacitor)

R1 = 1k $\Omega$  (R2 = 1 k $\Omega$ , R3 = 1M $\Omega$ )

When you greatly change the bias voltage while the DUT is being connected: if the switch S1 is closed temporarily, the charge-/discharging time of C2 can be shortened. Open the S1 during measurement. If you need the C2 to be remained in charged state while the DUT is not being mounted, use the R3

**Figure 4-7 External voltage bias circuit**

If great measurement error occurs during measurement of the low frequency or small impedance, increase the capacitance of C1 and C2. The error also can be reduced by the load correction.

In case of measurement of the large capacitance, if the impedance of DUT is excessively lower than the output impedance of LCR meter, decrease the R1 to 100 $\Omega$  as an example, so that the charge-/discharging time of DUT can be shortened.

However, the charge-/discharging current are increased by just that much.

The charge-/discharging current of DUT run through the L<sub>CUR</sub> terminal of LCR meter. Therefore, if the bias voltage is suddenly changed, the current sensing circuit of LCR meter is temporarily saturated and it is possible to disable the measurement. The bias voltage should be changed little by little to prevent a great amount of current from running.

R1 should be set to the value excessively higher than the parallel value between the output impedance of LCR meter and the impedance of DUT. Otherwise, the signal level decreases, thereby resulting in a terrible measurement error.

**⚠ WARNING**

Use the bias voltage within the following range:

$$(|\text{Bias voltage[V]}| + 1.41 \times \text{Measurement signal level [Vrms]}) < 42\text{V}$$

Otherwise, it may cause an electrical shock.

**When using the bias voltage beyond the above range, arrange the structural protection for preventing from touching the charging section. Do not touch the charged DUT.**

It is also possible to measure internal impedance of battery in the same manner as above. If you don't intend to take off the load current from the battery, connect the battery only after charging the C1 and C2 up to the electromotive force of battery by the external power. The external power should be removed during measurement. Or the resistance value R1 for charge-/discharging should be increased.

**■ Applying a DC bias current**

To measure while DC bias current is running through the DUT like Inductor, external power is needed. Turn off the DC bias output of **ZM2371 / ZM2372**.

Since the external power is connected with DUT in parallel, insert the choke coil having excessively higher impedance than that of DUT through the external power in series. It is impossible to make an OPEN correction while the bias current is running. Besides, to prevent the DC voltage and current from running through the LCR meter, insert the capacitor into the H<sub>CUR</sub> terminal and H<sub>POT</sub> terminal respectively in series. If it is possible that the LCR meter can be damaged due to the high voltage caused by the disconnected DUT, set the protective diode.

The bias current should be increased/decreased little by little. Sudden changing may cause a high voltage.

**⚠ WARNING**

**To connect/disconnect the DUT, the output of external power should be set to "0". Once the DUT like inductor is disconnected while the bias current is running, high voltage may be generated, thereby causing an electrical shock or damaging the LCR meter.**

**If the temperature of DUT can be increased during measurement, do not touch it until the temperature excessively drops after measurement. If high voltage or current is applied on the DUT for a long time, high temperature may cause a burn or DUT/ circumference can be burn out.**

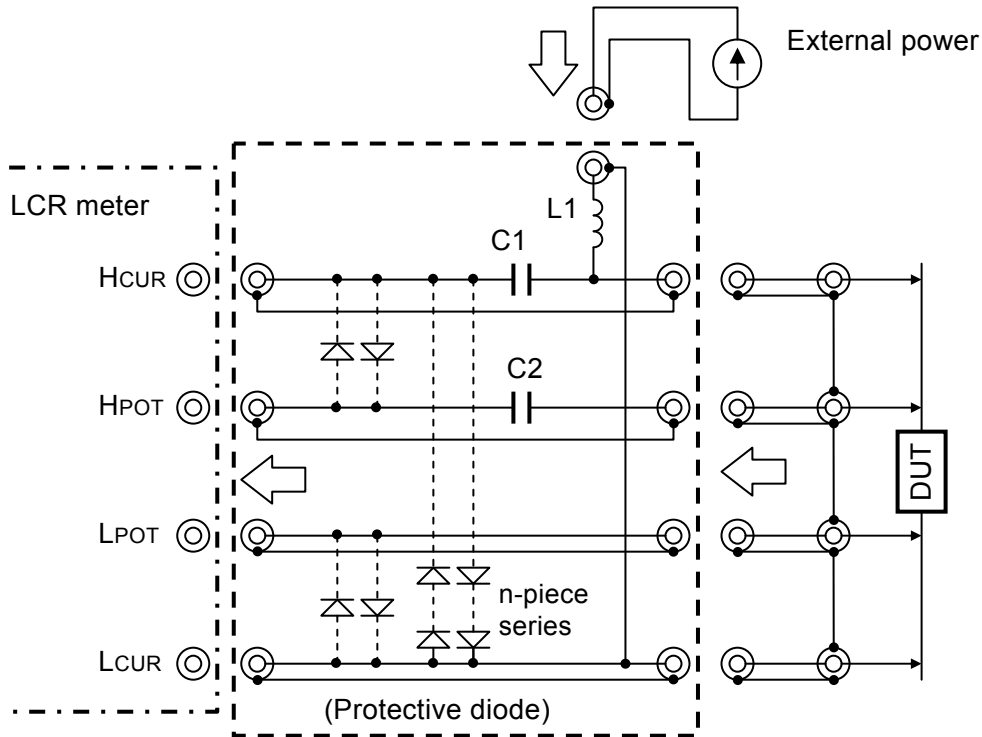

Element value: the following case shows the example of measurement taken at 1kHz or more in frequency:

C1=20 $\mu$ F (Film capacitor)

C2=4.7 $\mu$ F (Film capacitor)

Increase the impedance of L1 excessively higher than that of DUT.

The external power should be isolated from the ground. If the insulation impedance is low due to the high stray capacitance, LCR meter may get unstable, thus disabling the measurement.

The rectifier diode, which has an excessive peak current capacitance for preventing from damaging due to the bias current and also has a small backward leak current, is suitable as the protective diode. When the measurement signal level is 1Vrms, the number of series between H and L should be approx 8 pieces.

**Figure 4–8 External current bias circuit**

## 4.9 Disabling the Key-Operation of Panel

The key-operation of panel can be disabled.

### ■ Disabling/enabling the key-operation through the front panel

#### **SHIFT** + [ **KEY LOCK** ]

Press the **SHIFT** + [ **KEY LOCK** ] keys allows alternately switching between disabling (lock) and enabling (unlock) for key-operation.

However, even if key-operation is disabled, only the following functions are effective:

- Enabling function for the key-operation with the press **SHIFT** + [ **KEY LOCK** ] keys.
- Restoring function from Remote into Local (panel operation) with the press **LOCAL** key.

### KEY LOCK lamp

The KEY LOCK lamp of front panel lights up while the key-operation is being disabling.

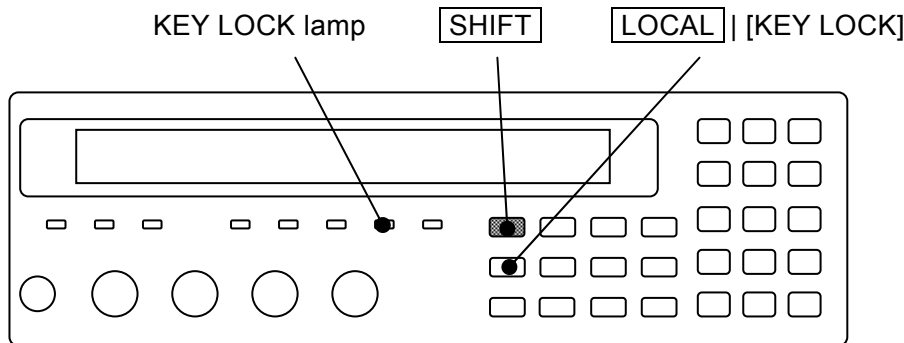

### ■ Disabling the key-operation through the Handler interface

For the **ZM2372**, if /KEY\_LOCK signal of handler interface is set to “1” (low level), the key-operation of panel can be disabled for that period. The /KEY\_LOCK signal is disabling all key-operation. Also in this case, the KEY LOCK lamp lights up.

Locking by the /KEY\_LOCK signal cannot be canceled by the panel operation or remote control interface. Only when the /KEY\_LOCK signal is set to “0” (high level), it can be canceled.

## 4.10 Initializing of All Settings

ZM2371 / ZM2372 can be initialized in some levels.

### ■ Initializing the current setting while the contents of setting and correction value memory are being left over

#### SHIFT + [ INIT ]

Press the **SHIFT** + **[INIT]** keys to display the initializing menu.

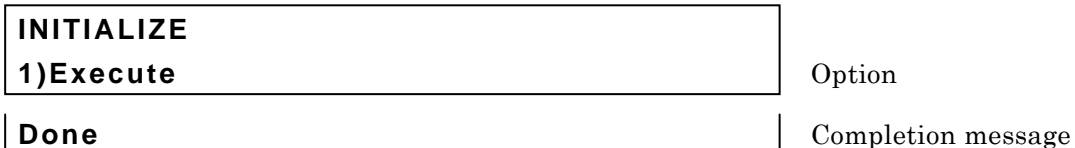

Press the **[1]** key and select the Execute, and the current setting and correction value return to the initial values.

After execution, the completion message appears for a short time and measurement screen comes back.

The following setting cannot be initialized but retained:

- 1) Contents of setting and correction value memory
- 2) Setting of interface (GPIB, RS-232)
- 3) Trigger polarity of handler interface

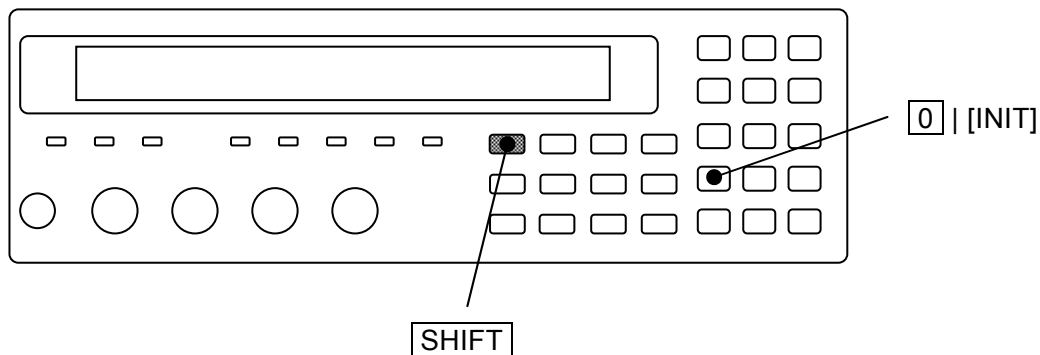

### ■ Fully initialization: Initializing all settings

Fully initialization is conducted in system setting menu.

#### **SHIFT** + [ **SYSTEM** ]

Press the **SHIFT** + [SYSTEM] keys to display the system setting menu.

<b>SYSTEM setting</b> <b>2)INITIALIZE ALL    3)SELF TEST</b> < >	Options (second page)
---	-----------------------

Press the **2** key to select the INITIALIZE ALL, and the following fully initialization setting menu is displayed.

<b>INITIALIZE ALL</b> <b>1)Execute</b>	Option
<b>Done</b>	Completion message

Perform the EXIT operation to return to one-previous menu.

If **1** key is pressed, following settings will return to factory default settings.

- 1) Current setting and correction value
- 2) Contents of setting and correction value memory
- 3) Setting of interface (GPIB, RS-232)
- 4) Trigger polarity of handler interface

After execution, the completion message appears for a short time and measurement screen comes back.

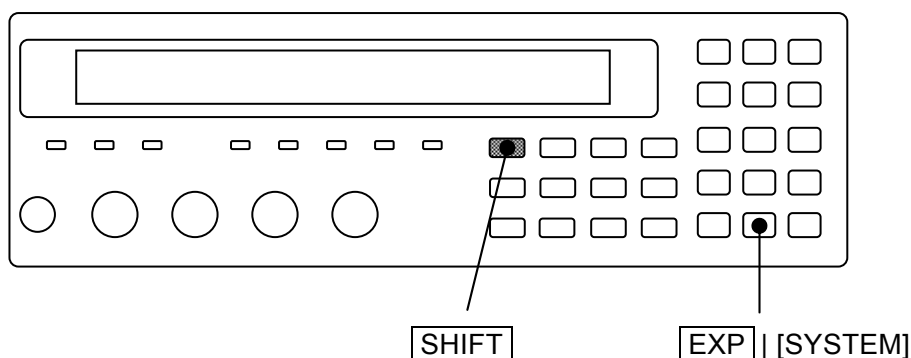

### ■ Initializing the operation mode

No need to initialize the operation mode for **ZM2371** where the standard operation mode (Mode 0) alone is built in.

It can be extended so as to provide two operation modes for **ZM2372**.

The operation mode cannot be initialized by the above two initializing operations.

To initialize the operation mode, set the operation mode to the initial value. Set the operation mode in the following orders.

Key-operation of <b>SHIFT</b> + <b>[SYSTEM]</b>	→ Displays the system setting menu
<b>[-]</b> <b>[2]</b> <b>[3]</b> <b>[0]</b> <b>[0]</b>	→ Displays the operation mode setting menu
<b>[0]</b> key	→ Select the Mode 0 (Initial value)

If the operation mode is set, same initial state as when “fully initialization” is executed in that mode is established. The initial settings are variable depending on each operation mode.

For details •••  “6.1 Outline of Operation Mode and Switching”.

### ■ Completely restoring to the setting before shipment

For **ZM2372** where extended so as to have two operation modes, in order to completely restore the conditions into those factory default settings and, set the operation mode to Mode 0 (initial value).

For the operation method •••  above mentioned “**Initializing the operation mode**”



## 4.11 Self-Diagnosis

The self-diagnosis function for analog measurement circuit is built in the **ZM2371 / ZM2372**. This function automatically runs when Power On, besides you can use it at your option.

### **SHIFT** + [ **SYSTEM** ]

Press the **SHIFT** + [SYSTEM] keys to display the system setting menu.

<b>SYSTEM setting</b> 2)INITIALIZE ALL 3)SELF TEST < >	Options (second page)
<b>SELF TEST</b> Running	Running message
<b>Passed</b>	Pass message
<b>Hardware failed</b>	Error message example

Press the **3** key to start the self-diagnosis, and display the “Running message”.

The self-diagnosis function finishes after several seconds, and if there is no error, the “Pass message” appears for a short time and the measurement screen comes back. It is impossible to interrupt this diagnosis function.

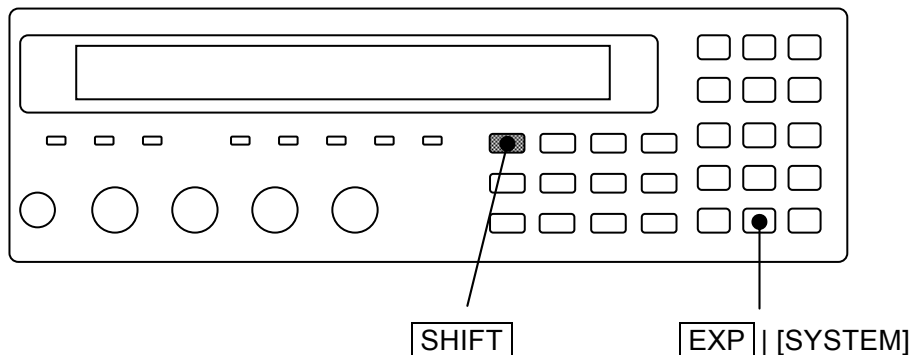

If there is an error, the following error message is displayed.

- Hardware failed                      Error of general measurement circuit
- Oscillator failed                    Error of drive signal source
- Analyzer failed                      Error of voltage/current measurement section

The serious error of measurement circuit can be detected by the self-diagnosis function. Slight error cannot be found. To enhance the reliability of measurement, we recommend you to make a periodical inspection such as starting inspection. The measurement of the DUT whose correct value was already identified enables even the slight error to be detected. To make a critical measurement, it is preferable to check before and after the measurement.

## 4.12 Checking the Version

The version of **ZM2371 / ZM2372** appears when power on, besides you can also check it in the system setting menu.

**SHIFT** + [ **SYSTEM** ]

Press the **SHIFT** + [SYSTEM] keys to display the system setting menu.

<b>SYSTEM setting</b> <b>4)VERSION</b>	<b>&lt;PREV</b>	Option (third page)
---	-----------------	---------------------

Press the **4** key to select the VERSION, and the version of **ZM2371 / ZM2372** is displayed.

<b>VERSION</b> <b>V1.00    2009/4/21 15:34</b>
---

VERSION    Date of final adjustment    (Both only displays, but cannot be set.)

This is an example indicating the display format. The displayed content is different from that of actual product.

Perform the EXIT operation to return to one-previous menu.

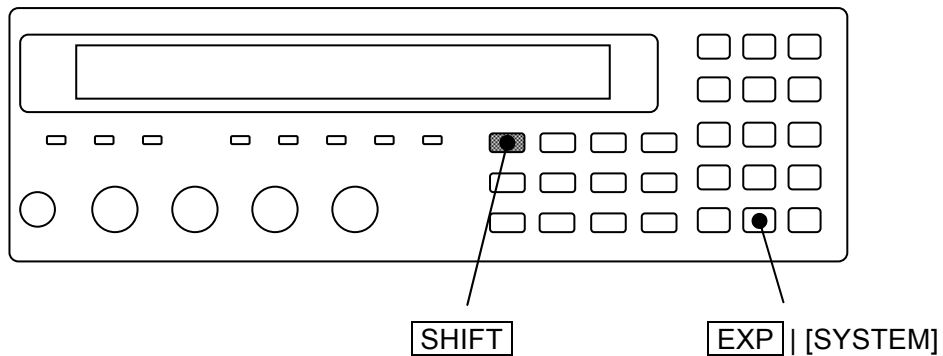

# 5. REMOTE CONTROL

5.1	Preparations Before Use .....	5-2
5.1.1	Remote Control Interface Selection.....	5-2
5.1.2	Outline of USB .....	5-3
5.1.2.1	Preparation of Controller .....	5-3
5.1.2.2	Preparation of ZM2371 / ZM2372 .....	5-4
5.1.2.3	USB Device Identification .....	5-4
5.1.3	Outline of RS-232.....	5-5
5.1.3.1	Preparation of Controller .....	5-5
5.1.3.2	Preparation of ZM2371 / ZM2372 .....	5-5
5.1.3.3	Connection .....	5-8
5.1.3.4	Difference between RS-232 and USB/GPIB, and Precautions .....	5-9
5.1.4	Outline of GPIB .....	5-10
5.1.4.1	Preparation of Controller .....	5-10
5.1.4.2	Preparation of ZM2372.....	5-10
5.1.4.3	Precautions on Use of GPIB.....	5-10
5.1.4.4	Basic Specifications of GPIB .....	5-11
5.1.5	Precautions on Communication.....	5-12
5.2	Switching between Remote State and Local State .....	5-13
5.3	Response to Interface Message.....	5-14
5.4	Command List .....	5-15
5.5	Command Tree .....	5-19
5.6	Command Explanation .....	5-21
5.6.1	Summary of Terms .....	5-21
5.6.1.1	Subsystem Commands .....	5-21
5.6.1.2	Path Separator .....	5-21
5.6.1.3	Keywords Simplification .....	5-22
5.6.1.4	Implicit Keywords .....	5-22
5.6.2	Overlap Commands and Sequential Commands .....	5-22
5.6.3	Command Detailed Explanations .....	5-23
5.6.3.1	Common Commands.....	5-24
5.6.3.2	Subsystem Commands .....	5-28
5.7	Status System .....	5-75
5.7.1	Status System Overview .....	5-75
5.7.2	Status Byte .....	5-76
5.7.3	Standard Event Status .....	5-77
5.7.4	Operation Status .....	5-79
5.8	Trigger System.....	5-82
5.9	Sample Programs .....	5-84

## 5.1 Preparations Before Use

**ZM2371** can be remote controlled by USB or RS232.

**ZM2372** can be remote controlled by GPIB, USB and RS232.

By sending program messages from the controller it is possible to control the device similarly to panel operations and to receive measured values or setting status as response messages.

The connectors of respective interfaces are located on the rear panel of the **ZM2371 / ZM2372**.

### 5.1.1 Remote Control Interface Selection

The **ZM2371 / ZM2372** use either one of USB, RS-232, and GPIB as a remote control interface. Plural interfaces cannot be used at the same time.

The setting of remote control interface is made from the system setting menu.

#### **SHIFT** + [ **SYSTEM** ]

Press the **SHIFT** + [SYSTEM] keys to display the system setting menu.



Select INTERFACE with the **0** key, and the remote control interface setting menu is displayed.



USB Selects USB (initial value) and displays the USB confirmation screen.

RS-232 Selects RS-232 and displays the RS-232 setting menu.

GPIB Selects GPIB and displays the GPIB address setting menu.

Select either one with a numeric key.

For the **ZM2371**, however, GPIB is not displayed as an option and cannot be selected.

Perform the EXIT operation to return to one-previous menu.

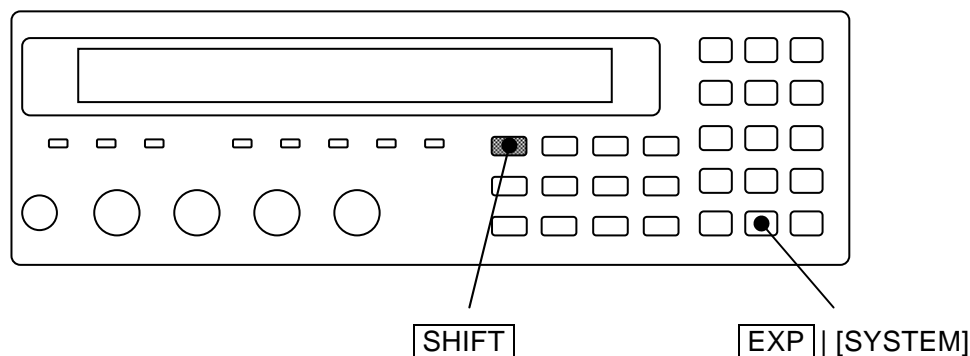

## 5.1.2 Outline of USB

### 5.1.2.1 Preparation of Controller

Prepare a personal computer equipped with the USB interface when using the USB interface.

Install the USBTMC driver in the computer that executes control. Normally, this driver supports the Subclass USB488, so that almost same control as GPIB can be executed through the USB.

USBTMC : Universal Serial Bus Test and Measurement Class

This driver is included in the hardware products or software products of respective companies that supply the VISA library. The user who does not have the license of VISA library must get it additionally.

VISA : Virtual Instrument Software Architecture

Example of companies that supply the VISA library (in random order)

National Instruments Corporation

Agilent Technologies, Inc.

Tektronix, Inc.

Using the VISA driver allows you to perform the unified operations whichever interface, USB, RS-232, or GPIB, is used.

### 5.1.2.2 Preparation of ZM2371 / ZM2372

If USB is selected with the remote control interface setting menu, the USB confirmation screen is displayed as shown below.

<b>USB</b>	<b>Vendor:3402</b>	<b>Product:22</b>	<b>SN:9083251</b>
			<b>EXIT</b>

Vendor Vendor ID = 3402 (decimal notation), which indicates NF Corporation.  
It is 0x0D4A in hexadecimal notation.

Product Product ID = 22 (decimal notation), which indicates **ZM2371**.  
Product ID = 23 (decimal notation), which indicates **ZM2372**.  
They are 0x0016 and 0x0017 respectively in hexadecimal notation.

SN Serial Number = 9083251 (example), which indicates 7-digit serial number uniquely assigned to each device.

Perform the EXIT operation to return to one-previous menu.

### 5.1.2.3 USB Device Identification

Connect the **ZM2371 / ZM2372** to the USB connector of the computer using commercially available USB cable. Connection via USB hub may result in an operation failure.

**ZM2371 / ZM2372** is automatically identified by connecting it with USB to the computer on which USBTMC class driver is installed.

The **ZM2371 / ZM2372** in the system is identified with the Vendor ID, Product ID, and Serial Number displayed on the USB confirmation screen. Use these values when specifying the device manually due to, for instance, automatic recognition error.

### 5.1.3 Outline of RS-232

#### 5.1.3.1 Preparation of Controller

When using the RS-232 interface, prepare a controller equipped with the connector for serial communication (RS-232) or install the interface card for serial communication in the controller.

Adjust the following parameters between **ZM2371 / ZM2372** and controller:

- Data rate                    4800 to 230400 bps
- Data length                8 bits
- Stop bit length            1 at transmission, 1 at reception
- Parity                      None
- Handshake                 None / Software / Hardware
- Terminator                CR / LF / CR LF

#### 5.1.3.2 Preparation of ZM2371 / ZM2372

If RS-232 is selected with the remote control interface setting menu, the RS-232 setting menu is displayed as shown below. Go to the sub menu for setting.

<b>RS-232</b>			
<b>0)Data Rate</b>	<b>1)Terminator</b>	<b>&gt;NEXT</b>	Options (first page)
<b>2)Handshake</b>		<b>&lt;PREV</b>	Options (second page)

Data Rate      Displays the data rate setting menu.

Terminator     Displays the message terminator setting menu when data is transmitted from **ZM2371 / ZM2372**.

Handshake     Displays the handshake setting menu.

Perform the EXIT operation to return to one-previous menu.

The following parameters are fixed on the **ZM2371 / ZM2372**. Adjust the settings on the controller side.

- Data length                8 bits
- Stop bit length            1 at transmission, 1 at reception
- Parity                      None

### ■ Data rate

The RS-232 data rate setting menu is as shown follows.

<b>RS-232 Data rate: 9600bps</b>	Current setting
<b>0)4800 1)9600 2)19200 3)38400 &gt;NEXT</b>	Options (first page)
<b>4)57600 5)115200 6)230400 &lt;PREV</b>	Options (second page)

Perform the EXIT operation to return to one-previous menu.

If the data rate is set, the result is displayed for a moment, and one-previous menu comes back.

The data rate is common to the transmission and reception.

Select the rate at which the communication can be made stably within the data rate range provided by both **ZM2371 / ZM2372** and controller. Even if a selection is made, when the data rate exceeds 19200 bps, stable communication may not be performed due to the restrictions of cable. For high speed communication, a short cable having low capacitance should be used.

### ■ Message terminator

A terminator indicating the termination is required at the end of a set of commands or response.

The RS-232 message terminator setting menu is as shown below.

<b>RS-232 Terminator:LF</b>	Current setting
<b>0)CR 1)LF 2)CR LF</b>	Options

CR Uses one character CR (Carriage Return) as a terminator.

LF Uses one character LF (Line Feed) as a terminator.

CR LF Uses two characters CR and LF as a terminator.

Perform the EXIT operation to return to one-previous menu.

- When **ZM2371 / ZM2372** transmits data  
The set terminator is added at the end of response message.
- When **ZM2371 / ZM2372** receives data  
The command is executed when CR or LF, whichever comes first, is received.

If the message terminator is set, the result is displayed for a moment, and one-previous menu comes back.



### ■ Handshake (flow control)

RS-232 Handshake setting menu is as shown follows.

<b>RS-232 Handshake:SOFT</b>	Current setting
<b>0)OFF 1)SOFT 2)HARD</b>	Options

OFF	No handshake (initial value)
SOFT	Software handshake (XON, XOFF) The communication is controlled with the control codes (XON, XOFF). Sure communication can be performed even with the cable connected to TxD, RxD, and GND only. However, binary data cannot be transferred. Also, effective speed may be lowered.
HARD	Hardware handshake (RTS, CTS) The communication is controlled with hardware control wires (RTS, CTS).

Perform the EXIT operation to return to one-previous menu.

If the handshake is set, the result is displayed for a moment, and one-previous menu comes back.

If the handshake is enabled, the transmission is suspended when the reception buffer becomes almost full, and it restarts when a space is made in the reception buffer.

**5.1.3.3 Connection**

Prepare commercially available connection cable separately. When connecting to the serial interface of personal computer, the following cable can be used.

Cable specification: D-Sub, 9 pins, female – female, interlink connection, inch screw.

To avoid radiation of electromagnetic noise or malfunction due to noise, the shielded cable must be used.

The communication can be made, provided that at least three cables of RxD, TxD, and GND are connected.

For the hardware handshake, RTS and CTS are required.

To utilize the hardware handshake, use the interlink cable (Figure 5-1 (b)). For cross or reverse connection, a type in which adjacent pins 7 and 8 are connected (Figure 5-1 (c)) is possible. With this type, the communication can be made, but it cannot be used for the hardware handshake.

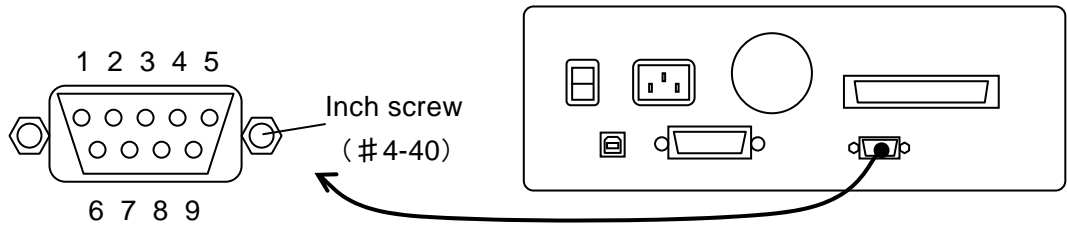

(a) RS-232 connector on rear panel

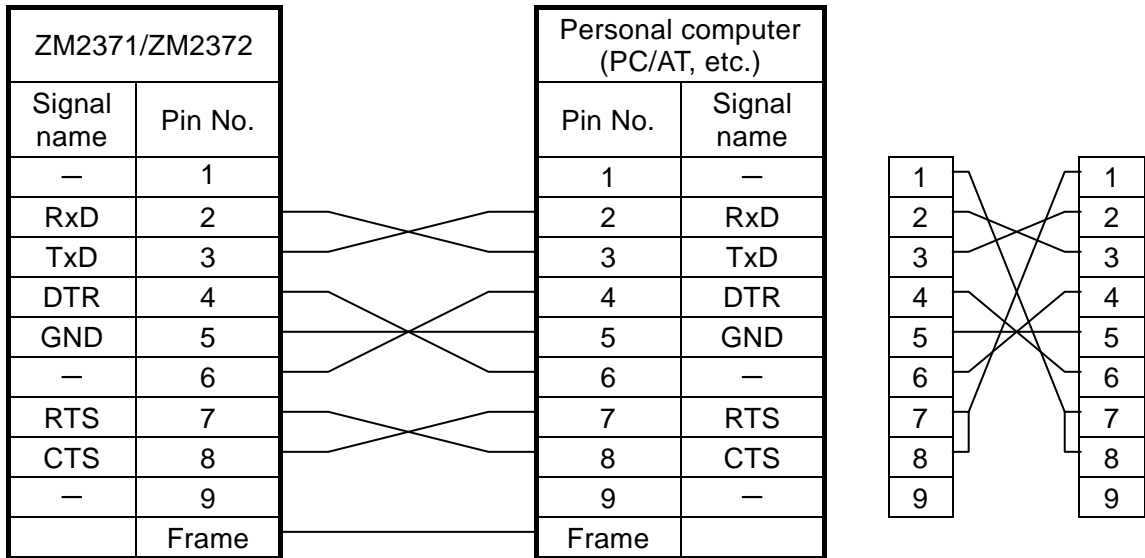

(b) Interlink connection

(c) Other cross connection

**Figure 5-1 RS-232 cable connection diagram**

#### 5.1.3.4 Difference between RS-232 and USB/GPIB, and Precautions

The RS-232 is different from USB and GPIB in the following points:

- **RS-232 is connected to the controller in one-to-one relation.**

Multiple devices cannot be connected in parallel to one port.

- **GPIB own functions cannot be used. The following shows an example.**

Device clear (DCL, SDC) message

GTL (Go To Local) message

LLO (Local Lockout) message

GET (Group Execute Trigger) message

REN (Remote Enable) message

SRQ (Service Request) and serial polling

END message (EOI signal as a message terminator)

- **Remote/Local switching operation is different.**

When the **ZM2371 / ZM2372** receives a command via RS-232, it goes in the remote state and the operation from the panel is disabled.

Press the **LOCAL** key to return to the local state, and the operation from the panel is enabled. Also use the key lock function when the panel operation is to be disabled.

- **Clear the reception buffer before starting the communication.**

With the RS-232 communication path opened by the controller, turning on/off the power of **ZM2371 / ZM2372**, or connecting/disconnecting the RS-232 connector causes abnormal data to enter the reception buffer in the controller. Accordingly, when the communication is started or restarted with the program on the controller, be sure to execute initialization that includes the clear of reception buffer before performing usual operation.

### 5.1.4 Outline of GPIB

The GPIB interface was designed to be used in favorable environment. Avoid the use in a place with much noise.

#### 5.1.4.1 Preparation of Controller

Install commercially available GPIB card or controller board in the computer for control and connect with the GPIB cable. For the GPIB driver software, refer to the instruction manual of the GPIB card or controller board used.

#### 5.1.4.2 Preparation of ZM2372

For the GPIB, the device in the system is identified with the device unique address. Set a unique GPIB address to each device. The GPIB address of the **ZM2372** is set through the procedure given below.

##### ■ GPIB address setting

Select GPIB with the remote control interface setting menu, and the GPIB address setting menu as shown below is displayed.

<b>GPIB Address: 2</b> <b>0 to 30</b>
--

Current setting

Range of settable values

Perform the EXIT operation to return to one-previous menu.

If the GPIB address is set, the result is displayed for a moment, and one-previous menu comes back.

##### ■ Message terminator

A terminator indicating the termination is required at the end of a set of commands or response.

The response message terminator that **ZM2372** transmits is fixed to LF^EOI.

The program message terminator that **ZM2372** receives is either of the followings:

- LF                                      Line Feed code
- LF^EOI                                LF accompanied by EOI (END message)
- (Last code)^EIO                    EOI (END message) added to the last code

#### 5.1.4.3 Precautions on Use of GPIB

- Connect or disconnect the GPIB connector with all devices connected to the bus turned off.
- Turn on the power of all devices connected to the bus when using the GPIB.
- The number of devices connectable to one bus via GPIB is maximum 15 units including the controller.

Also, the cable length is limited as follows:

– Total cable length  $\leq (2\text{m} \times \text{Number of devices or } 20\text{m, whichever short})$

– Length of one cable  $\leq 4\text{m}$

- For GPIB address, set a different value for each device. If plural devices having same address exist on one bus, the devices may be damaged due to the conflict of output.

---

#### 5.1.4.4 Basic Specifications of GPIB

##### ■ GPIB conforming standards

IEEE std 488.1-1987, IEEE std 488.2-1992

##### ■ IEEE std 488.1-1987 interface functions

SH1	Source Handshake full functions provided
AH1	Acceptor Handshake full functions provided
T6	Basic Talker, Serial Poll, and talker cancel function by listener-addressed provided Talk-Only function not provided
L4	Basic Listener function and listener cancel function by talker-addressed provided Listen-Only function not provided
SR1	Service Request full functions provided
RL1	Remote Local full functions provided
PP0	Parallel Poll function not provided
DC1	Device Clear full functions provided
DT1	Device Trigger full functions provided
C0	Controller function not provided
E1	Open collector drive

### 5.1.5 Precautions on Communication

#### ■ Input buffer

- The sent commands are stored in the input buffer once, and they are interpreted and executed in order.  
The input buffer capacity is 1K bytes (K=1024). Even program messages exceeding this size are all interpreted and executed in order.
- If a command out of the specification is found during interpretation or execution, an error occurs and after that, the command is not executed until the program message terminator is reached.

#### ■ Output buffer

- The output buffer capacity is 64K bytes (K=1024).
- If exceeding the maximum capacitance, the output buffer is cleared and the query error bit of standard event status register is set to "1". After that, the command interpretation and execution are performed as usual, but the response messages generated until the program message terminator is reached are all dumped.

#### ■ Error queuing

- The number of error messages that can be retained is maximum 16.
- If exceeding this capacity, 16th error message changes to "Queue overflow" indicating that the error queue overflows. Error messages after that are dumped. Error messages up to 15th message are retained.

#### ■ Program message terminator

When a command is sent from the controller, add LF (Line Feed, 0A hex) at the end of transmitted character string as a program message terminator. Also, add EOI (END message) to the last byte. Sending a command without adding LF or EOI causes a malfunction in some devices.

The program message terminator may not be output unless the program message terminator is specified in addition to the command body, depending on the driver software used in the computer for control. Though a new line (NL) may be expressed in place of line feed (LF), the binary code is same.

The RS-232 does not have the concept of END message and therefore it does not need EOI to be added.

## 5.2 Switching between Remote State and Local State

In relation to the remote control, **ZM2371 / ZM2372** has the remote state and the local state. In the local state, all panel operations are enabled.

In the remote state, the panel operations are disabled, except the operation to return to the local.

### ■ Selecting the remote state

Normally, the operation from USB or GPIB sets the remote state. This is caused by the GPIB driver's function on the controller side. According to the communication standard, if the REN message is set to "true" and the device is specified as a listener, that device becomes remote state.

### ■ Selecting the local state

Press the **LOCAL** key on the front panel, and the remote state is switched to the local state (except when local is locked out).

Or, send the GTL command from the controller or return the REN line to "false", so that the local state can be set. If the GPIB cable is disconnected, the REN line becomes "false" and thus the local state is returned. Similarly, disconnecting the USB cable causes the device to be returned to the local state.

### ■ Disabling local operations from the panel

Accidental local operations can be disabled by specifying the local lockout from the controller. During the local lockout, the device cannot return to the local state even if the **LOCAL** key is pressed.

Even during the local lockout, the local state can be returned from the controller.

### ■ RS-232

Send a command to the **ZM2371 / ZM2372**, and the **ZM2371 / ZM2372** becomes remote state.

Press the **LOCAL** key to return the device to the local state.

The local lockout function cannot be used.

### REMOTE lamp

In the remote state, the REMOTE lamp lights up.

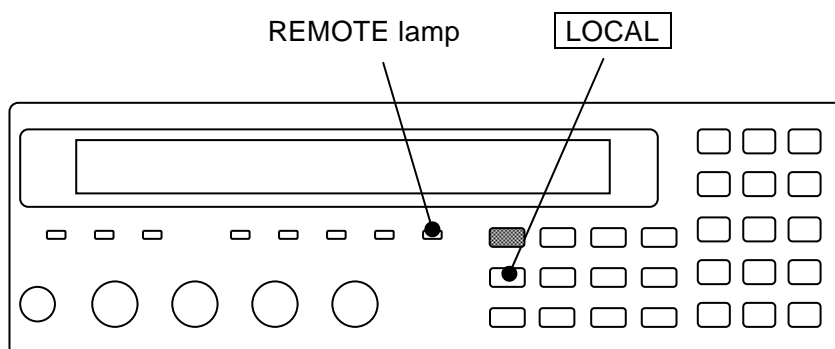

## 5.3 Response to Interface Message

The responses to main IEEE-488.1 interface messages are as listed below.

**Table 5–1 Responses to interface messages**

Message	Function
IFC	<p>&lt; InterFace Clear &gt;</p> <p>Initializes the GPIB interface.</p> <p>Releases the specified listener and talker.</p>
DCL,SDC	<p>&lt; Device CLear &gt;, &lt; Selected Device Clear &gt;</p> <p>Clears the input buffer and stops interpretation and execution of a command.</p> <p>Clears the output queue and clears the bit 4 (MAV) of status byte register.</p> <p>Releases the overlap command queuing by *WAI, *OPC, and *OPC? commands.</p> <p>Releases the trigger waiting state by READ? query.</p>
LLO	<p>&lt; Local LockOut &gt;</p> <p>Disables the transition from remote state to local state by pressing the <span style="border: 1px solid black; padding: 2px;">LOCAL</span> key on the panel.</p>
GTL	<p>&lt; Go To Local &gt;</p> <p>Selects the local state.</p>
GET	<p>&lt; Group Execute Trigger &gt;</p> <p>Executes the trigger. Same function as *TRG command.</p>

How to send an interface message from the controller is different depending on the device driver. For details, see the instruction manual of each driver.



## 5.4 Command List

**ZM2371 / ZM2372** commands are separated into the common commands defined by IEEE488.2 and subsystem commands that reflect device-specific functions.

The **ZM2371 / ZM2372** has different command systems depending on the operation mode.

This section describes standard operation mode. For other operation modes, see “**6. Change of Operation Mode**”.

Common commands that **ZM2371 / ZM2372** provides are listed in **Table 5-2**. Also, subsystem commands of **ZM2371 / ZM2372** are listed in **Table 5-3**.

The meaning of codes used in **Table 5-2** and **Table 5-3** are explained below. It is possible to omit the keywords lowercase character parts.

- Keywords shown in square brackets ( [ ] ) are those that support omission. (implicit keyword)
- The vertical bar ( | ) indicates the possibility to select a keyword from several keywords.

**Table 5-2 Common command list**

Command	Name	Function
*CLS	Clear Staus Command	Clears status data
*ESE *ESE?	Standard Event Status Enable Command / Query	Sets/queries the standard event status enable register.
*ESR?	Standard Event Status Register Query	Queries the standard event status register contents.
*IDN?	Identification Query	Queries the device identification information (model name etc).
*OPC *OPC?	Operation Complete Command / Query	Requests to set the Standard Event Status register's OPC bit to 1 when all command operations are completed. In response to query, it returns 1 when all operations are completed.
*OPT?	Option Identification Query	Queries the built-in options.
*RCL	Recall Command	Recalls the contents of specified settings memory.
*RST	Reset Command	Resets the device and initializes the settings.
*SAV	Save Command	Saves current settings in the specified settings memory.
*SRE *SRE?	Service Request Enable Command / Query	Sets/queries the service request enable register.
*STB?	Read Status Byte Query	Queries the status byte.
*TRG	Trigger Command	Applies a trigger to execute measurement once when the trigger source is BUS and the device waits for a trigger, and reads the measured data when measurement finished.
*TST?	Self-Test Query	Queries the self test result. “0” (no error) is returned, if normal.
*WAI	Wait-to-Continue Command	Waits for executing the following commands until all of the preceding command operations are completed.

Table 5–3 Subsystem command list (1/3)

Command	Function / Operation target
<b>ABORt subsystem</b>	
:ABORt	Aborts the measurement
<b>CALCulate subsystem</b>	
:CALCulate:COMPARator:AUXBin	Enables the use of auxiliary bins
:CALCulate:COMPARator:BEEPer:CONDition	Beeper sounding condition
:CALCulate:COMPARator:BEEPer[:STATe]	Enables the use of beeper
:CALCulate:COMPARator:CLEar	Initializes comparator settings
:CALCulate:COMPARator:MODE	Comparator primary parameter comparison format
:CALCulate:COMPARator:PRIMary:BIN{1 2 ... 14}	Bin (primary parameter) lower & upper limit values
:CALCulate:COMPARator:PRIMary:BIN{1 2 ... 14}:STATe	Enables bin sorting (primary parameter)
:CALCulate:COMPARator:PRIMary:NOMinal	Reference value for primary parameter deviation
:CALCulate:COMPARator:SECondary:LIMit	Secondary parameter lower & upper limit values
:CALCulate:COMPARator:SECondary:STATe	Enables secondary parameter comparison
:CALCulate:COMPARator[:STATe]	Enables the use of comparator
:CALCulate:COMPARator:EXTension[:STATe]	Enables bin extended function *1
:CALCulate:FORMat:AUTO[:STATe]	Enables measurement parameter auto selection
<b>CALCulate1 subsystem</b>	
:CALCulate1:CKIT:AUTO[:STATe]	Enables equivalent circuit auto selection
:CALCulate1:FORMat	Selects primary parameter
:CALCulate1:LIMit:CLEar	Clears primary parameter comparator result
:CALCulate1:LIMit:FAIL?	Queries primary parameter comparison result
:CALCulate1:LIMit:LOWer[:DATA]	Primary parameter BIN1 lower limit value
:CALCulate1:LIMit:LOWer:STATe	Enables primary parameter BIN1 lower limit comparison
:CALCulate1:LIMit:STATe	Enables primary parameter BIN1 sorting
:CALCulate1:LIMit:UPPer[:DATA]	Primary parameter BIN1 upper limit value
:CALCulate1:LIMit:UPPer:STATe	Enables primary parameter BIN1 upper limit comparison
:CALCulate1:MATH:EXPRession:NAME	Primary parameter deviation display format
:CALCulate1:MATH:STATe	Enables primary parameter deviation display / output
<b>CALCulate2 subsystem</b>	
:CALCulate2:FORMat	Selects secondary parameter
:CALCulate2:LIMit:CLEar	Clears secondary parameter comparator result
:CALCulate2:LIMit:FAIL?	Queries secondary parameter comparison result
:CALCulate2:LIMit:LOWer[:DATA]	Secondary parameter lower limit value
:CALCulate2:LIMit:LOWer:STATe	Enables secondary parameter lower limit comparison
:CALCulate2:LIMit:STATe	Enables secondary parameter comparison
:CALCulate2:LIMit:UPPer[:DATA]	Secondary parameter upper limit value
:CALCulate2:LIMit:UPPer:STATe	Enables secondary parameter upper limit comparison
:CALCulate2:MATH:EXPRession:NAME	Secondary parameter deviation display format
:CALCulate2:MATH:STATe	Enables secondary parameter deviation display / output

Supplement: The command that makes inquiry is called “query” and it terminates with a question mark. In this table, the query is omitted in the functions capable of making both setting and query.

\*1: Only for **ZM2372**. Unusable for **ZM2371**.

Table 5–3 Subsystem command list (2/3)

Command	Function / Operation target
<b>CALCulate3 subsystem</b>	
:CALCulate3:MATH:STATe	Enables IV monitor display
<b>CALCulate4 subsystem</b>	
:CALCulate4:MATH:STATe	Enables IV monitor display
<b>CALibration subsystem</b>	
:CALibration:CABLe	Cable length correction
<b>DATA subsystem</b>	
:DATA[:DATA]	Reference value for primary & secondary parameter deviation display
:DATA[:DATA]?	Queries reference value for deviation display, contents of data buffer, and IV monitored value
:DATA:FEED	Recorded data in measured data buffer
:DATA:FEED:CONTRol	Enables recording in measured data buffer
:DATA:POINts	Measured data buffer virtual size and initialization
<b>DISPlay subsystem</b>	
:DISPlay[:WINDow][:STATe]	Enables measured value display (enabled at all times)
:DISPlay[:WINDow]:TEXT1:DIGit	Number of measured value display digits (fixed)
:DISPlay[:WINDow]:TEXT1:PAGE	Measured value/Comparator result selection (both at all times)
:DISPlay[:WINDow]:TEXT2:PAGE	Auxiliary display item (function limited)
:DISPlay[:WINDow]:TEXT3[:PAGE]	Auxiliary display item
<b>FETCh subsystem</b>	
:FETCh?	Query of latest measured data
<b>FORMat subsystem</b>	
:FORMat[:DATA]	Measured data transfer format
<b>INITiate subsystem</b>	
:INITiate:CONTinuous	Continuous starting of trigger system
:INITiate[:IMMEDIATE]	Starting of trigger system
<b>READ subsystem</b>	
:READ?	Trigger, and data query after measurement
<b>SENSe subsystem</b>	
[:SENSe]:AVERAge:COUNT	Averaging count
[:SENSe]:AVERAge[:STATe]	Enables the averaging
[:SENSe]:CORRection:CKIT:STANdard1:FORMat	Format of OPEN correction value
[:SENSe]:CORRection:CKIT:STANdard2:FORMat	Format of SHORT correction value
[:SENSe]:CORRection:CKIT:STANdard3	Standard value for LOAD correction
[:SENSe]:CORRection:CKIT:STANdard3:FORMat	Format of LOAD correction value / standard value
[:SENSe]:CORRection:COLLect[:ACQuire]	Measurement of correction value
[:SENSe]:CORRection:COLLect:METHod	Correction operating target
[:SENSe]:CORRection:DATA	Correction value
[:SENSe]:CORRection:LIMit:LOW	Correction lower limit frequency
[:SENSe]:CORRection:LOAD[:STATe]	Enables LOAD correction
[:SENSe]:CORRection:OPEN[:STATe]	Enables OPEN correction
[:SENSe]:CORRection:SHORT[:STATe]	Enables SHORT correction
[:SENSe]:CORRection:SPOT[:STATe]	Enables SPOT correction measurement
[:SENSe]:CORRection[:STATe]	Enables correction in a lump

Table 5-3 Subsystem command list (3/3)

Command	Function / Operation target
<b>SENSe subsystem (Continued)</b>	
[ :SENSe][ :FIMPedance]:APERTure[:MODE]	Measurement speed / measurement time
[ :SENSe][ :FIMPedance]:CONtact:VERify	Enables contact check *1
[ :SENSe][ :FIMPedance]:CONtact:RVERify	Enables real time check *1
[ :SENSe][ :FIMPedance]:RANGe:AUTO	Enables measurement range auto switching
[ :SENSe][ :FIMPedance]:RANGe[:UPPer]	Measurement range
[ :SENSe]:FRESistance:RANGe:AUTO	Enables Rdc measurement range auto switching
[ :SENSe]:FRESistance:RANGe[:UPPer]	Rdc measurement range
[ :SENSe]:FUNctIon:CONCurrent	Enables execution of multiple measurements
[ :SENSe]:FUNctIon[:ON]	Specifies measurement function
<b>SOURce subsystem</b>	
:SOURce:CURRent:ALC[:STATe]	Enables constant current drive
:SOURce:CURRent[:LEVel][[:IMMediate]][[:AMPLitude]	Constant current level
:SOURce:FREQuency[:CW]	Measurement frequency
:SOURce:RESistance[:LIMit]:LOW	Minimum output impedance
:SOURce:VOLTagE:ALC[:STATe]	Enables constant voltage drive
:SOURce:VOLTagE[:LEVel][[:IMMediate]][[:AMPLitude]	Measurement voltage level
:SOURce:VOLTagE[:LEVel][[:IMMediate]:OFFSet	DC bias voltage
:SOURce:VOLTagE[:LEVel][[:IMMediate]:OFFSet:STATe	Enables DC bias
:SOURce:VOLTagE:MODE	Enables triggered drive
<b>STATus subsystem</b>	
:STATus:OPERation:CONDition?	Queries the condition (OPCR)
:STATus:OPERation:ENABLE	Enables an event (OPEE)
:STATus:OPERation[:EVENT]?	Queries an event (OPER)
<b>SYSTem subsystem</b>	
:SYSTem:ERRor?	Queries the content of error
:SYSTem:KLOCK	Enables key lock
:SYSTem:MEMory	Selects settings / correction value *1
:SYSTem:RCL	Recalls settings / correction value
:SYSTem:SAVE	Saves settings / correction value
<b>TRIGger subsystem</b>	
:TRIGger:SOURce	Trigger source
:TRIGger[:IMMediate]	Trigger (measurement start)
:TRIGger:DELay	Trigger delay time

\*1: Only for **ZM2372**. Unusable for **ZM2371**.

## 5.5 Command Tree

The subsystem command tree of the **ZM2371 / ZM2372** is shown below.

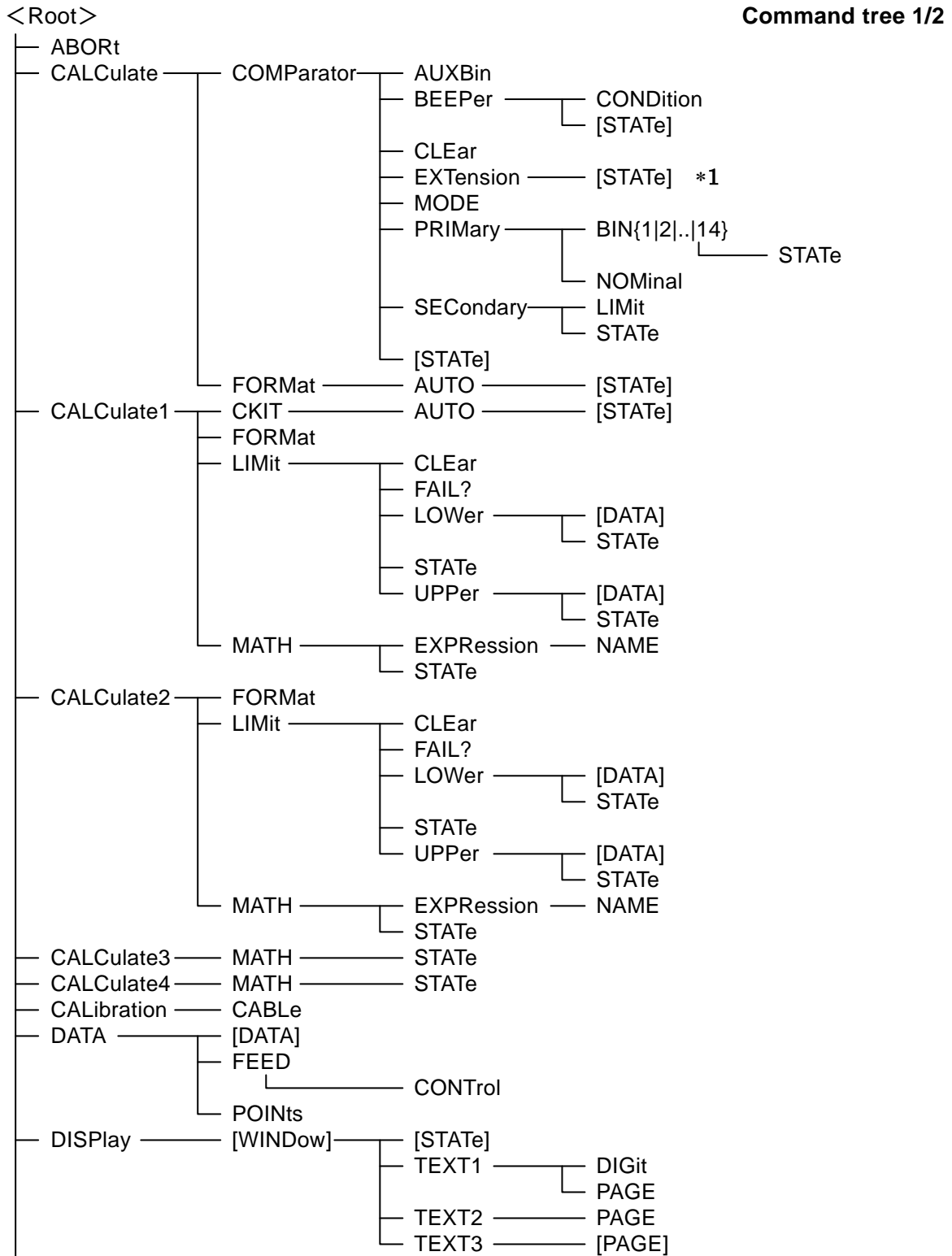

Continued

Keywords shown in square brackets ([ ]) are omissible.

Command tree 2/2

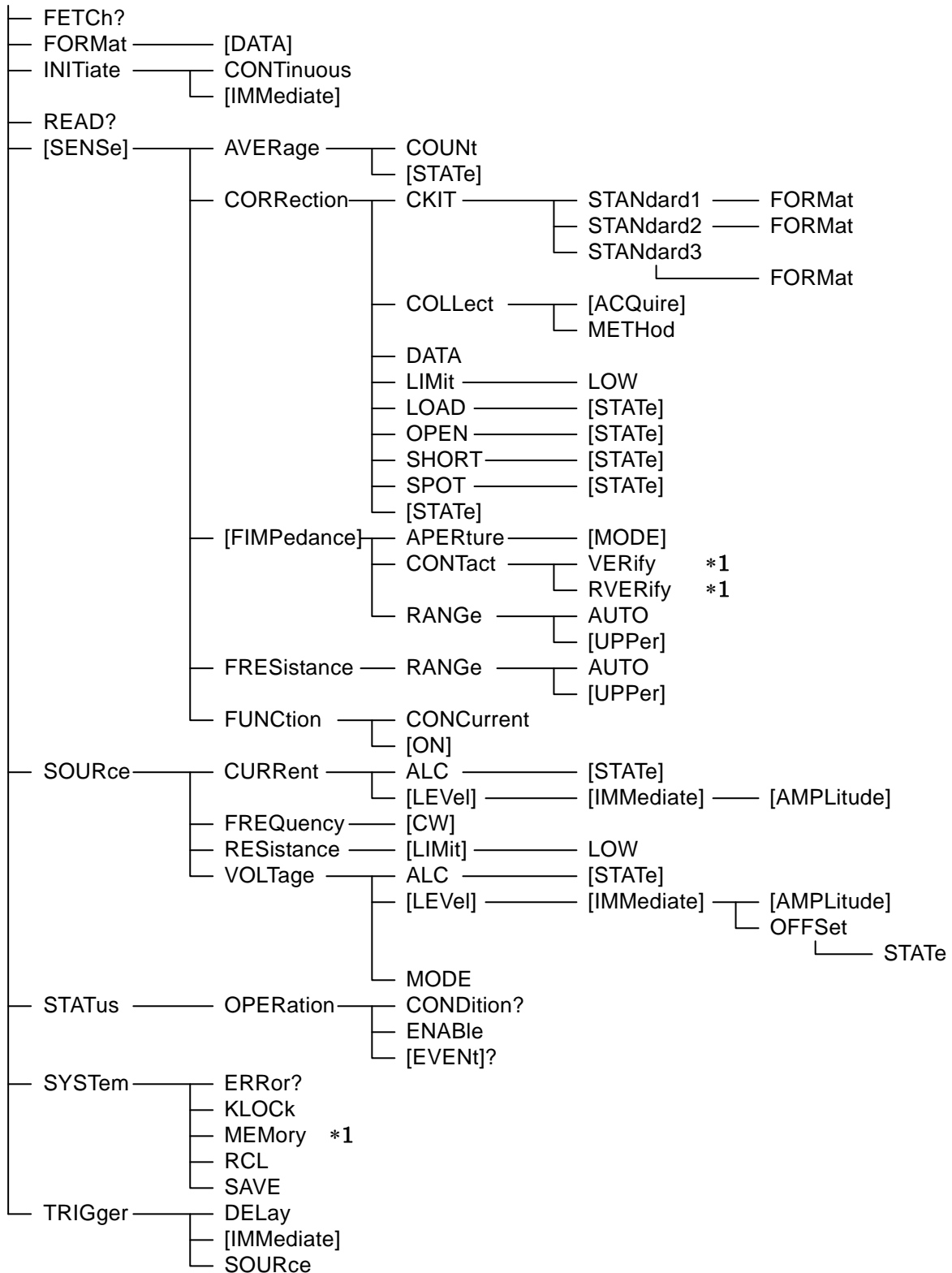

\*1: Only for ZM2372



### 5.6.1.3 Keywords Simplification

In this Instruction Manual, a keyword indicating a command or parameter is expressed with a combination of uppercase and lowercase alphabets. Uppercase characters are used for short form (abbreviation). Even if lowercase character part is all omitted, it has the same function as long form that includes all the lowercase character part. However, only a part of lowercase character part cannot be omitted.

Uppercase and lowercase characters are used only as an expedient means to explicit the form that can be shortened but device makes no distinction whatsoever between the two. It is possible to use both simultaneously.

Example: Command notation :CALCulate1:FORMat?

→ :calculate1:format?	Acceptable (long form, all lowercase character)
:Calc1:Form?	Acceptable (short form mixed uppercase/lowercase characters)
:CALCUL1:FORM?	Not Acceptable (wrong intermediary abbreviated form)
:CALC1:FOR?	Not Acceptable (omission over- abbreviated)

### 5.6.1.4 Implicit Keywords

Keywords shown in square brackets ([ ]) indicate the implicit keywords and are omissible. The device performs same operation if all or part of implicit keyword is omitted or even if not omitted at all. In the following example, both command notations have same function to the device. The following examples show a device function using both ways.

Example: Command notation [:SENSE]:AVERAGE[:STATE] ON

→ :SENS:AVER:STAT ON	Implicit keyword is not omitted
:AVER ON	Implicit keyword is all omitted

## 5.6.2 Overlap Commands and Sequential Commands

Some commands allow the following commands to be executed simultaneously during execution of them, and some commands do not allow.

### ■ Overlap commands

During execution of that command, the following command can be executed.

Note that executing multiple overlap commands will result in an operation failure.

### ■ Sequential commands

After execution of that command finished, the following command is executed.

Use \*WAI, \*OPC, and \*OPC? commands when you don't want to execute the following commands or query until the execution of overlap commands finished.

The commands given below are overlap commands. Other commands are all sequential commands.

Overlap commands : [:SENSE]:CORRection:COLLect[:ACQuire]



### 5.6.3 Command Detailed Explanations

The function and syntax of all the commands shown in “Table 5-2 Common command list” and “Table 5-3 Subsystem command list” are explained below.

#### 【Meaning of symbols】

- Keywords shown in square brackets ([ ]) are those that support omission (implicit keywords)
- Curly braces ({ }) indicate parameters in the command character string.
- The vertical bar (|) indicates possibilities to select a keyword from several choices.
- Comparison marks (< >) indicate that a parameter such as numerical values and character strings need to be set.

These symbols are used for description only. They are not used in actual commands.

Description                   [:SENSEs][:FIMPedance]:RANGe:AUTO {ON|OFF|1|0}  
Actual command       :SENSE:FIMPedance:RANGe:AUTO ON

#### 【Parameters data format】

Symbol	Format	Ex.
NR1	Integer (numeric value)	123
NR2	Decimal point format no having exponent (numeric value)	0.072
NR3	Decimal point format having exponent (numeric value)	4.99E+06
CRD	Character strings	ALL
SRD	Character strings in double quotation marks	"No error"
bool	Logical value	ON, OFF, 1, 0

- Unless otherwise specified individually, a numeric value in any format is accepted and it is rounded to the nearest value if exceeding the specified resolution.
- Unless otherwise specified individually, a numeric value is set to minimum value if below the minimum value, or set to maximum value if above the maximum value.
- For numeric value parameters in which the description is made so that MAX / MIN can be used, a numeric value is set to maximum value if MAX (or MAXIMUM) is given, or set to minimum value if MIN (or MINIMUM) is given.
- When the response is a numeric value, and the range, resolution and unit are omitted, it is same as a setting. Unless otherwise specified individually, the significand of response in NR3 format is 6 digits.
- For the commands in which the parameter type varies depending on the format setting, even if a numeric value exceeding the range mentioned below is given, it is rounded to the same range as displayed on panel or resolution. For the range of actually set value, see the description of operation panel.
- Character strings in quotation marks are accepted in single or double quotation marks.

#### 【Remarks】

- Both commands and queries are called commands here.  
The keyword attached with “?” at the end is a query.
- Response messages to commands do not come with headers.

### 5.6.3.1 Common Commands

#### \*CLS

Description: Clears the following statuses.

- Standard event status register
- Operation event register
- Status byte
- Error queue

Also, the error display on the panel is reset.

Setting example: \*CLS

Remarks: The \*CLS command does not directly clear the status byte register. Except for the MAV bit and the RQS bit, the status byte is indirectly cleared. It is possible to indirectly clear the MAV bit by clearing the input buffer with a device clear. It is possible to clear the RQS bit by reading out the status with the serial pole.

#### \*ESE <mask>

#### \*ESE?

Description: Sets/queries the standard event status enable register.

Parameters: <mask> {numeric value, range 0 - 255}

Out of range value causes an error.

For details . . .  **“5.7.3 Standard Event Status”**

Setting example: \*ESE 255

Sets 255 to the standard event status enable register.

Response: <mask> {numeric value, format NR1, range 0 - 255}

Query example: \*ESE?

Response example: +255

The content of standard event status enable register is 255.

#### \*ESR?

Description: Queries the standard event status register contents.

The query clears all the standard event status register bits to 0.

Response: <register contents> {numeric value, format NR1, range 0 - 255}

For details . . .  **“5.7.3 Standard Event Status”**

Query example: \*ESR?

Response example: +128

The content of standard event status register is 128.

**\*IDN?**

Description: Queries the model name etc.  
 Response: {"<name of manufacturer>, <model name>, <serial number>, <firmware version>"} format SRD  
 Query example: \*IDN?  
 Response example: "NF Corporation,ZM2371,9033552,Ver1.00"

**\*OPC****\*OPC?**

Description: Confirms that the execution of all the preceding commands is completed.  
 Setting example: \*OPC  
 Makes setting so that OPC bit of standard event status register is set to "1" when the execution of all the preceding commands is completed. By monitoring the status, the completion of command execution can be known.  
 Response: 1  
 1 is returned when the execution of all the preceding commands is completed.  
 Query example: \*OPC?  
 Response example: 1  
 Remarks: The execution of all commands is completed.  
 The OPC bit of standard event status register is not cleared by \*OPC?. To clear it, use the device clear, \*CLS, or \*RST command.

**\*OPT?**

Description: Queries options that are furnished in the device.  
 Response: {numeric value, format NR1, range {0 | <option 1>[,<option 2>][,<option 3>] . . . } }  
 Format of each field  
           0          No option is furnished.  
           Others      At present, no option is provided.  
 Query example: \*OPT?  
 Response example: +0  
 No option is furnished.

**\*RCL <memory number>**

Description: Recalls the settings from the specified settings memory.  
 Parameters: <memory number> {numeric value, range 0 - 31}  
 Out of range value causes an error.  
 Setting example: \*RCL 5  
 Recalls the settings from the settings memory number 5.  
 Remarks: To recall correction values, use the :SYSTem:RCL command.

**\*RST**

Description: Resets to initial setting state.  
 For details . . . ☞ **“Table 3-1 Setting items and initial values”**  
 Setting example: \*RST  
 Remarks: Beware of the following points:
 

- OPEN, SHORT, and LOAD correction values are initialized. When using previous correction values, save them in advance, and recall them after \*RST.
- . . . ☞ :SYSTem:SAVE, :SYSTem:RCL commands
- The initial value of trigger delay time is not zero.

**\*SAV <memory number>**

Description: Saves the currently used setting to the specified setting memory.  
 Parameters: <memory number> {numeric value, range 0 - 31}  
 Out of range value causes an error.  
 Setting example: \*SAV 5  
 Saves current settings in the settings memory number 5.  
 Remarks: To save correction values, use the :SYSTem:SAVE command.

**\*SRE <SRQ mask>****\*SRE?**

Description: Sets/queries the service request enable register.  
 Parameters: <SRQ mask> {numeric value, range 0 - 255}  
 Out of range value causes an error.  
 For details . . . ☞ **“5.7.1 Status System Overview”**  
 Setting example: \*SRE 128  
 Response: {numeric value, format NR1, range 0 - 255}  
 Query example: \*SRE?  
 Response example: +128  
 The content of service request enable register is 128.

**\*STB?**

Description: Queries the content of status byte register.  
 Response: <register contents> {numeric value, format NR1, range 0 - 255}  
 For details . . . ☞ **“5.7.2 Status Byte”**  
 Query example: \*STB?  
 Response example: +128  
 The content of status byte register is 128.

**\*TRG**

- Description: When the device waits for a trigger, a trigger is applied to execute measurement once, and when the measurement finished, the measured data is read. When the trigger source is not BUS or when the device does not wait for a trigger, a trigger is not applied, causing an error.
- Setting example: **\*TRG**  
Applies a trigger, and reads the measured data when new measured data is obtained.
- Response: <measurement status>, <primary parameter measured value>, <secondary parameter measured value>  
[, {comparator bin sorting} | <limit comparison result>] ]  
Response message is same as :FETCh? query.  
For details . . . ☞ **:FETCh?**

**\*TST?**

- Description: Queries the self diagnosis results.  
**ZM2371 / ZM2372** conducts self t diagnosis and returns its result.
- Response: {numeric value, format NR1, range 0 - 3}  
0 : Pass (no abnormality is found)  
1 : Hardware failed (whole measurement circuits are faulty)  
2 : Oscillator failed (drive signal source is faulty)  
3 : Analyzer failed (voltage & current measuring section is faulty)
- Query example: TST?
- Response example: +0  
No abnormality was found in the self diagnosis.

**\*WAI**

- Description: Waits until all the commands have been processed before executing later commands.
- Example: Overlap command 1 ; Overlap command 2 ; \*WAI ; following command <program message terminator>  
After the execution of both overlap command 1 and overlap command 2 finished, the following commands are executed.
- Remarks: The waiting caused by the \*WAI can be canceled with device clear.

### 5.6.3.2 Subsystem Commands

#### **:ABORt**

Description: Aborts the measurement and places the trigger system in idle state. When continuous initiation of trigger system is enabled, the device goes in trigger waiting state automatically. Further when the trigger source is set to INT (internal), a new trigger is applied automatically to start the measurement. The measurement of OPEN, SHORT, and LOAD correction values is aborted.

Setting example: :ABOR

#### **:CALCulate:COMParator:AUXBin {ON|OFF|1|0}**

#### **:CALCulate:COMParator:AUXBin?**

Description: Sets/queries whether S-NG (primary parameter is within the range but secondary parameter is out of range) is used as auxiliary bins (AUX\_BIN) independent from OUT OF BINS when the bin sorting is performed by the comparator function.

Parameters: {ON | 1} S-NG is used as auxiliary bins.  
When judged as S-NG, OUT OF BINS is not output.

{OFF | 0} S-NG is not used as auxiliary bins.  
When judged as S-NG, both S-NG and OUT OF BINS are output. OUT OF BINS includes both primary parameter out of range and secondary parameter out of range.

Setting example: :CALC:COMP:AUXB ON  
Sets so that S-NG is used as auxiliary bins.

Response: {1 | 0}

Query example: :CALC:COMP:AUXB?

Response example: 1  
S-NG is used as auxiliary bins.

**:CALCulate:COMParator:BEEPer:CONDition {FAIL|PASS}****:CALCulate:COMParator:BEEPer:CONDition?**

Description: Sets/queries whether the beeper sounds when the comparator result does not fall in BIN1....BIN14 or when the result falls in the range. To sound the beeper, enable the beeper by giving additionally the :CALCulate:COMParator:BEEPer[:STATe] command.

Parameters: **FAIL** The beeper sounds when the comparator result is other than BIN1...BIN14 (namely, OUT OF BINS, S-NG, ERR). In the limit comparison, the beeper sounds when the comparator result is not IN.

**PASS** The beeper sounds when the comparator result is within BIN1...BIN14. In the limit comparison, the beeper sounds when the comparator result is IN.

Setting example: :CALC:COMP:BEEP:COND FAIL  
Sets so that the beeper sounds when the comparator result does not fall in BIN1 - BIN14.

Response: {FAIL|PASS}

Query example: :CALC:COMP:BEEP:COND?

Response example: FAIL  
The beeper sounds when the comparator result does not fall in BIN1 - BIN14.

**:CALCulate:COMParator:BEEPer[:STATe] {ON|OFF|1|0}****:CALCulate:COMParator:BEEPer[:STATe]?**

Description: Sets or queries whether the beeper is enabled or disabled. If disabled, the beeper does not sound regardless of comparator result.

Parameters: {ON|1} Enables the beeper.  
{OFF|0} Disables the beeper.

Setting example: :CALC:COMP:BEEP ON  
Enables the beeper.

Response: {1|0}

Query example: :CALC:COMP:BEEP?

Response example: 1  
The beeper is enabled.

**:CALCulate:COMParator:CLEar**

Description: Initializes the comparator setting.  
For details . . . ☞ **“Table 4-1 Initialization contents of comparator”**

Setting example: :CALC:COMP:CLE  
Initialize the comparator setting.

**:CALCulate:COMParator:EXTension[:STATe] {ON|OFF|1|0}****:CALCulate:COMParator: EXTension[:STATe]?**

Description:	Sets/queries whether the bin extended function of comparator functions is used or not.
Parameters:	{ON 1} Enables the bin extended function (BIN10 - BIN14). {OFF 0} Disables the bin extended function (BIN10 - BIN14). When the bin extended function is enabled, BIN10 - BIN14 signals of handler interface can be used. Instead, the PHI and PLO signals are not output. When the bin extended function is disabled, BIN10 - BIN14 sorting is not executed. Instead, the PHI and PLO signals of handler interface can be used.
Setting example:	:CALC:COMP:EXT ON Sets so that the bin extended function is enabled.
Response:	{1 0}
Query example:	:CALC:COMP:EXT?
Response example:	1 The bin extended function is enabled.
Remarks:	This command cannot be used for <b>ZM2371</b> . An error will occur.

**:CALCulate:COMParator:MODE {ABS|DEV|PCNT}****:CALCulate:COMParator:MODE?**

Description:	Sets/queries the comparison format of primary parameters when the bin sorting is executed by the comparator function. This format is common to the display format of primary parameters.
Parameters:	ABS Compares absolute value (original measured value). DEV Compares deviation from reference value (= measured value - reference value). PCNT Compares percent value of deviation (to reference value).
Setting example:	:CALC:COMP:MODE PCNT Sets so that the percent value of deviation is compared.
Response:	{ABS DEV PCNT}
Query example:	:CALC:COMP:MODE?
Response example:	PCNT The percent value of deviation is compared.
Remarks:	The comparison format of secondary parameters follows the display format of primary parameters.

**--- Absolute value ---**

For ABS, the comparison is made to original measured value. A negative value is not converted into a positive value. Original measured value including a sign is used.

**--- Unit of value ---**

The unit of upper limit value, lower limit value, and reference value for deviation comparison of primary and secondary parameters is interpreted according to the parameter type or setting of deviation measurement. For example, if the capacitance C is displayed, the unit is interpreted as F (farad), or if a percent value of deviation is displayed, the unit is interpreted as %.



**:CALCulate:COMParator:PRIMary:BIN{1|2|3|4|5|6|7|8|9|10|11|12|13|14}****<lower limit value>, <upper limit value>****:CALCulate:COMParator:PRIMary:BIN{1|2|3|4|5|6|7|8|9|10|11|12|13|14}?**

- Description: Sets/queries the primary parameters (lower limit value, upper limit value) to BIN1 - BIN14. To execute comparison, set “:CALCulate:COMParator:PRIMary:BIN{1..14}:STATe” additionally so as to execute bin sorting.  
The unit depends on the type of primary parameters to be measured or the setting of deviation display.
- Parameters: <lower limit value> {OFF|numeric value, range 0, ± (1E-16 to 9.99999E+11) }  
<upper limit value> {OFF|numeric value, range 0, ± (1E-16 to 9.99999E+11) }  
In either case, MAX / MIN can be used.  
OFF corresponds to No Limit of panel operation.
- Setting example: :CALC:COMP:PRIM:BIN1 11.2345E-06, 12.3456E-06  
Sets the lower limit value of BIN1 to 11.2345E-06, and the upper limit value to 12.3456E-06.
- Response: <lower limit value>, <upper limit value> {OFF|numeric value, format NR3}
- Query example: :CALC:COMP:PRIM:BIN1?
- Response example: +1.12345E-05, +1.23456E-05  
The lower limit value of BIN1 is 1.12345E-05, and the upper limit value is 1.23456E-05.

**:CALCulate:COMParator:PRIMary:BIN{1|2|3|4|5|6|7|8|9|10|11|12|13|14}:STATe {ON|OFF|1|0}****:CALCulate:COMParator:PRIMary:BIN{1|2|3|4|5|6|7|8|9|10|11|12|13|14}:STATe?**

- Description: Sets/queries whether the primary parameters set to the BIN1 - BIN14 are compared or not by the comparator function.
- Parameters: {ON|1} Enables sorting of that bin (that bin is used for sorting)  
{OFF|0} Disables sorting of that bin (that bin is not used for sorting)
- Setting example: :CALC:COMP:PRIM:BIN2:STAT ON  
Sets so that BIN2 sorting is executed.
- Response: {1|0}
- Query example: :CALC:COMP:PRIM:BIN2:STAT?
- Response example: 1  
BIN2 sorting is executed.

**:CALCulate:COMParator:PRIMary:NOMinal <reference value>****:CALCulate:COMParator:PRIMary:NOMinal?**

- Description: Sets/queries reference value used when primary parameter is compared to obtain deviation or deviation % by the comparator function. It is common to the reference value of deviation display.
- Parameters: <reference value> {numeric value, range 0, ± (1E-16 to 9.99999E+11) }  
The unit depends on the parameter. MAX / MIN can be used.
- Setting example: :CALC:COMP:PRIM:NOM 12.0000E-06  
Sets reference value of primary parameters to 12.0000E-06.
- Response: <reference value> {numeric value, format NR3}
- Query example: :CALC:COMP:PRIM:NOM?
- Response example: +1.20000E-05  
Reference value of primary parameters is 1.20000E-05.

**:CALCulate:COMParator:SECondary:LIMit <lower limit value>, <upper limit value>**

**:CALCulate:COMParator:SECondary:LIMit?**

**Description:** Sets/queries the lower limit value and upper limit value of secondary parameters when the secondary parameters are compared by the comparator function. To execute comparison, set “:CALCulate:COMParator:SECCondary:STATE” additionally so as to execute secondary parameters comparison.

**Parameters:** <lower limit value> {OFF|numeric value, range 0, ± (1E-16 to 9.99999E+11) }  
<upper limit value> {OFF|numeric value, range 0, ± (1E-16 to 9.99999E+11) }  
The unit depends on the parameter. In either case, MAX / MIN can be used.

**Setting example:** :CALC:COMP:SEC:LIM OFF, 0.01  
Sets the lower limit value of secondary parameters to “no limit”, and the upper limit value to 0.01.

**Response:** <lower limit value>, <upper limit value> {OFF| numeric value, format NR3}

**Query example:** :CALC:COMP:SEC:LIM?

**Response example:** OFF,+1.00000E-02  
The lower limit value of secondary parameters is “no limit”, and the upper limit value is 0.01.

**:CALCulate:COMParator:SECondary:STATe {ON|OFF|1|0}**

**:CALCulate:COMParator:SECondary:STATe?**

**Description:** Sets whether the secondary parameters are compared or not by the comparator function.

**Parameters:** {ON|1} Secondary parameters are compared.  
{OFF|0} Secondary parameters are not compared.

**Setting example:** :CALC:COMP:SEC:STAT ON  
Sets so that secondary parameter comparison is executed.

**Response:** {1|0}

**Query example:** :CALC:COMP:SEC:STAT?

**Response example:** 1  
Secondary parameter comparison is executed.

**:CALCulate:COMParator[:STATe] {ON|OFF|1|0}**

**:CALCulate:COMParator[:STATe]?**

Description:	Sets/queries whether the comparator function (bin sorting) is used or not.		
Parameters:	{ON   1}	Enables the comparator function.	
	{OFF   0}	Disables the comparator function.	
Setting example:	:CALC:COMP ON Sets so that the comparator function (bin sorting) is enabled.		
Response:	{1   0}		
Query example:	:CALC:COMP?		
Response example:	1		
Remarks:	The comparator function (bin sorting) is enabled. If the comparator function is set to ON (enabled), <ul style="list-style-type: none"> <li>• The comparator result is displayed on the panel, and</li> <li>• For <b>ZM2372</b>, the comparator result is output to the handler interface.</li> <li>• The limit comparison function for primary and secondary parameters is set to OFF (disabled).</li> </ul> If the comparator function is set to OFF (disabled), <ul style="list-style-type: none"> <li>• The limit comparison function for primary and secondary parameters is also set to OFF (disabled).</li> </ul> Besides the bin sorting, the following limit comparison can be used.		

#### ■ Limit comparison function

In the remote control, a set of numeric value range is specified respectively for primary parameters and secondary parameters, so that they can be used for limit comparison function. If either limit comparison function of primary parameters or secondary parameters is enabled, the comparator operation changes from bin sorting to limit comparison. The limit comparison function cannot be enabled by the panel operation.

When the limit comparison function is enabled,

- The COMPTR lamp on the front panel lights up.
- A set of upper and lower limit values is used for screening of primary parameters. The values are common to BIN1 of bin sorting.
- A set of upper and lower limit values is used for screening of secondary parameters. The values are common to bin sorting.
- When the display format of primary and secondary parameters is deviation or deviation %, the comparison format for limit comparison is also deviation or deviation %.
- BIN2 - BIN14 sorting is not executed. Setting to BIN1 - BIN14 is possible.
- The limit comparison is performed regardless of the settings of comparator function (bin sorting).
- The display of measured value on the front panel is same as when the comparator function (bin sorting) is enabled.
- The setting of limit comparison is displayed in the comparator setting menu (see below for instance).

	Limit comparison function is enabled	Limit comparison function of primary parameter is enabled	Limit comparison function of secondary parameter is disabled	
<b>Comparator:L/U</b>	<b>ABS</b>	<b>Pri-ON</b>	<b>Sec-OFF</b>	Current setting
<b>0)OFF 1)ON 2)DEV</b>			<b>&gt;NEXT</b>	Options (first page)

The primary parameter limit comparison fail flag which is a response of `:CALCulate1:LIMit:FAIL?` query is updated when a new measured value is obtained. At this time, it is assumed as pass if the limit comparison function of primary parameters is set to OFF (disabled). This is also true for the secondary parameters. The limit comparison fail flag is initialized to “0” (pass) when the power is turned on. It can also be initialized by the `*RST` command, initialize operation with the initialize menu or system setting menu, or `:CALCulate{1|2}:LIMit:CLEar` command.

**`:CALCulate:FORMat:AUTO[:STATe] {ON|OFF|1|0}`**

**`:CALCulate:FORMat:AUTO[:STATe]?`**

**Description:** Sets/queries whether primary and secondary measurement parameters are selected automatically.

**Parameters:** `{ON|1}` Enables the automatic selection of measurement parameter.  
`{OFF|0}` Disables the automatic selection of measurement parameter.

**Setting example:** `:CALC:FORM:AUTO ON`  
 Sets to enables the automatic selection of measurement parameter.

**Response:** `{1|0}`

**Query example:** `:CALC:FORM:AUTO?`

**Response example:** 1

**Remarks:** The automatic selection of parameter is enabled.  
 Automatic selection of measurement parameters is automatically disabled in the following cases:

- When a primary parameter is set
- When a secondary parameter is set
- When automatic selection of equivalent circuit is set to OFF (disabled)
- When a setting is made with `:SENSe:FUNcTION` command

**`:CALCulate1:CKIT:AUTO[:STATe] {ON|OFF|1|0}`**

**`:CALCulate1:CKIT:AUTO[:STATe]?`**

**Description:** Sets/queries whether equivalent circuit is selected automatically when the primary parameter is set to either R, C, or L.

**Parameters:** `{ON|1}` Enables the automatic selection of equivalent circuit.  
`{OFF|0}` Disables the automatic selection of equivalent circuit.

**Setting example:** `:CALC1:CKIT ON`  
 Sets to enables the automatic selection of equivalent circuit.

**Response:** `{1|0}`

**Query example:** `:CALC1:CKIT?`

**Response example:** 1  
 The automatic selection of equivalent circuit is enabled.

**:CALCulate1:FORMat {Z|Y|R|RP|RS|G|C|CP|CS|L|LP|LS|REAL|MLINear}****:CALCulate1:FORMat?**

Description:	Sets/queries the primary parameter (and equivalent circuit) to be measured.																																				
Parameters:	<p>Z            Magnitude of impedance  Z  (unit: ohm <math>\Omega</math>)</p> <p>Y            Magnitude of admittance  Y  (unit: S siemens)</p> <p>R            Resistance Rp or Rs (unit: <math>\Omega</math>)</p> <p>RP          Resistance Rp expressed with parallel equivalent circuit (unit: <math>\Omega</math>)</p> <p>RS          Resistance Rs expressed with series equivalent circuit (unit: <math>\Omega</math>)</p> <p>G            Conductance GP expressed with parallel equivalent circuit (unit: S)</p> <p>C            Capacitance Cp or Cs (unit: F farad)</p> <p>CP          Capacitance Cp expressed with parallel equivalent circuit (unit: F farad)</p> <p>CS          Capacitance Cs expressed with series equivalent circuit (unit: F farad)</p> <p>L            Inductance Lp or Ls (unit: H henry)</p> <p>LP          Inductance Lp expressed with parallel equivalent circuit (unit: H henry)</p> <p>LS          Inductance LS expressed with series equivalent circuit (unit: H henry)</p> <p>REAL       Real part of immittance (either Rs or Gp)</p> <p>MLINear   Magnitude of immittance ( Z  or  Y )</p> <p>Note: Immittance is generic name of impedance and admittance.</p>																																				
Setting example:	<p>:CALC1:FORM CS</p> <p>Sets the primary parameter to the capacitance expressed with series equivalent circuit.</p>																																				
Response:	{Z Y R RP RS G C CP CS L LP LS REAL MLIN}																																				
Query example:	:CALC1:FORM?																																				
Response example:	<p>CS</p> <p>The primary parameter is the capacitance expressed with series equivalent circuit.</p>																																				
Remarks:	<p>Equivalent circuit assumed in the measurement of primary parameters is as follows:</p> <table border="0" style="margin-left: 20px;"> <tr> <td>Z, Y</td> <td>Not depend on the equivalent circuit.</td> </tr> <tr> <td>RS, CS, LS</td> <td>Series equivalent circuit</td> </tr> <tr> <td>RP, CP, LP, G</td> <td>Parallel equivalent circuit</td> </tr> </table> <p>These parameters do not depend on [:SENSE]:FUNCTION[:ON] command and equivalent circuit setting.</p> <p>REAL, MLINear, R, C, L</p> <p>These parameters depend on [:SENSE]:FUNCTION[:ON] command and equivalent circuit setting.  See below.</p> <p>&lt;When automatic selection of equivalent circuit is disabled, (:CALC1:CKIT:AUTO OFF)&gt;</p> <table border="0" style="margin-left: 20px;"> <tr> <td>[:SENSE]:FUNCTION[:ON]</td> <td>REAL</td> <td>MLINear</td> <td>R</td> <td>C</td> <td>L</td> </tr> <tr> <td>FIMPedance (Series equivalent circuit)</td> <td>Rs</td> <td> Z </td> <td>Rs</td> <td>Cs</td> <td>Ls</td> </tr> <tr> <td>FADMittance (Parallel equivalent circuit)</td> <td>G</td> <td> Y </td> <td>Rp</td> <td>Cp</td> <td>Lp</td> </tr> <tr> <td>FIMPedance,FRESistance</td> <td>Rs</td> <td> Z </td> <td>Rs</td> <td>Cs</td> <td>Ls</td> </tr> <tr> <td>FADMittance,FRESistance</td> <td>Rp</td> <td> Y </td> <td>Rp</td> <td>Cp</td> <td>Lp</td> </tr> </table> <p>&lt;When automatic selection of equivalent circuit is enabled, (:CALC1:CKIT:AUTO ON)&gt;</p> <p>For R, C, and L, the equivalent circuit automatic selecting function has priority over the setting of [:SENSE]:FUNCTION[:ON].</p>	Z, Y	Not depend on the equivalent circuit.	RS, CS, LS	Series equivalent circuit	RP, CP, LP, G	Parallel equivalent circuit	[:SENSE]:FUNCTION[:ON]	REAL	MLINear	R	C	L	FIMPedance (Series equivalent circuit)	Rs	Z	Rs	Cs	Ls	FADMittance (Parallel equivalent circuit)	G	Y	Rp	Cp	Lp	FIMPedance,FRESistance	Rs	Z	Rs	Cs	Ls	FADMittance,FRESistance	Rp	Y	Rp	Cp	Lp
Z, Y	Not depend on the equivalent circuit.																																				
RS, CS, LS	Series equivalent circuit																																				
RP, CP, LP, G	Parallel equivalent circuit																																				
[:SENSE]:FUNCTION[:ON]	REAL	MLINear	R	C	L																																
FIMPedance (Series equivalent circuit)	Rs	Z	Rs	Cs	Ls																																
FADMittance (Parallel equivalent circuit)	G	Y	Rp	Cp	Lp																																
FIMPedance,FRESistance	Rs	Z	Rs	Cs	Ls																																
FADMittance,FRESistance	Rp	Y	Rp	Cp	Lp																																

**:CALCulate1:LIMit:CLEar**

Description: Clears the primary parameter limit comparison fail flag to “0” (pass).

Setting example: :CALC1:LIM:CLE

Clears the primary parameter limit comparison fail flag.

**:CALCulate1:LIMit:FAIL?**

Description: Queries whether the primary parameter limit comparison result is “fail” or not.

Response: {1|0}

1: Fail (LO or HI)

0: Pass (IN)

Query example: :CALC1:LIM:FAIL?

Response example: 0

The primary parameter is “pass”.

**— — — Upper and lower limit values of primary parameters in limit comparison — — —**

The upper and lower limit values used for the limit comparison function are common to those of BIN1 for the comparator function (bin sorting). Either setting has same effect.

**:CALCulate1:LIMit:LOWer[:DATA] <lower limit value>****:CALCulate1:LIMit:LOWer[:DATA]?**

Description: Sets/queries the lower limit value of primary parameters used for limit comparison.

Parameters: <lower limit value> {numeric value, range 0, ± (1E-16 to 9.99999E+11) }

MAX / MIN can be used.

Setting example: :CALC1:LIM:LOW 1.23456E-06

Sets the lower limit value of primary parameters used for limit comparison to 1.23456μ.

Response: <lower limit value> {numeric value, format NR3}

Query example: :CALC1:LIM:LOW?

Response example: +1.23456E-06

The lower limit value of primary parameters used for limit comparison is 1.23456μ.

**:CALCulate1:LIMit:LOWer:STATe {ON|OFF|1|0}****:CALCulate1:LIMit:LOWer:STATe?**

Description: Sets/queries whether the lower limit value is compared or not in the limit comparison of primary parameters.

Parameters: {ON|1} Lower limit value is compared.

{OFF|0} Lower limit value is not compared (corresponding to No Limit of panel operation).

Setting example: :CALC1:LIM:LOW:STAT ON

Sets so that the lower limit value is compared in the primary parameter limit comparison.

Response: {1|0}

Query example: :CALC1:LIM:LOW:STAT?

Response example: 1

The lower limit value is compared in the primary parameter limit comparison.

**:CALCulate1:LIMit:STATe {ON|OFF|1|0}****:CALCulate1:LIMit:STATe?**

Description:	Sets/queries whether the limit comparison function of primary parameter is used or not.
Parameters:	{ON   1} Enables the limit comparison function of primary parameter. {OFF   0} Disables the limit comparison function of primary parameter.
Setting example:	:CALC1:LIM:STAT ON Sets to enables the limit comparison function of primary parameter.
Response:	{1   0}
Query example:	:CALC1:LIM:STAT?
Response example:	1
Remarks:	The limit comparison function of primary parameter is enabled. When the primary parameter limit comparison function is enabled, <ul style="list-style-type: none"> <li>• the comparator operation changes to the limit comparison, and</li> <li>• BIN2 - BIN14 sorting is not executed. (Bin sorting is restricted)</li> <li>• The comparator result is displayed on the panel, and also</li> <li>• the comparator result is output to the handler interface.</li> </ul> When the primary parameter limit comparison function is disabled, the comparator function is set to OFF (disabled) if the secondary parameter limit comparison is disabled.

**:CALCulate1:LIMit:UPPer[:DATA] < upper limit value>****:CALCulate1:LIMit:UPPer[:DATA]?**

Description:	Sets/queries the upper limit value of primary parameters used for limit comparison.
Parameters:	<upper limit value> {numeric value, range 0, ± (1E-16 to 9.99999E+11) } MAX / MIN can be used.
Setting example:	:CALC1:LIM:UPP 12.3456E-06 Sets the upper limit value of primary parameters used for limit comparison to 12.3456μ.
Response:	<upper limit value> {numeric value, format NR3}
Query example:	:CALC1:LIM:UPP?
Response example:	+1.23456E-05 The upper limit value of primary parameters used for limit comparison is 1.23456E-05(=12.3456μ).

**:CALCulate1:LIMit:UPPer:STATe {ON|OFF|1|0}****:CALCulate1:LIMit:UPPer:STATe?**

Description: Sets/queries whether the upper limit value is compared or not in the limit comparison of primary parameters.

Parameters: {ON|1} Upper limit value is compared.  
 {OFF|0} Upper limit value is not compared (corresponding to No Limit of panel operation).

Setting example: :CALC1:LIM:UPP:STAT ON  
 Sets so that the upper limit value is compared in the primary parameter limit comparison.

Response: {1|0}

Query example: :CALC1:LIM:UPP:STAT?

Response example: 1  
 The upper limit value is compared in the primary parameter limit comparison.

**:CALCulate1:MATH:EXPRession:NAME {DEV|PCNT}****:CALCulate1:MATH:EXPRession:NAME?**

Description: Sets/queries the deviation display format of primary parameters. To display the deviation, set the deviation display format, and further set so that the deviation is displayed using :CALCulate1:MATH:STATe ON command.  
 Set the referenced value with :DATA[:DATA] command.

Parameters: DEV Deviation: Deviation from reference value (= measured value – reference value) is displayed.  
 PCNT Deviation %: Deviation (to reference value) is displayed with percent value.

Setting example: :CALC1:MATH:EXPR:NAME PCNT  
 Sets the deviation display format of primary parameters to deviation %.

Response: {DEV|PCNT}

Query example: :CALC1:MATH:EXPR:NAME?

Response example: PCNT  
 The deviation display format of primary parameters is deviation %.

**:CALCulate1:MATH:STATe {ON|OFF|1|0}****:CALCulate1:MATH:STATe?**

Description: Sets/queries whether the primary parameter deviation display / output is executed or not.

Parameters: {ON|1} Enables the deviation display / output.  
 {OFF|0} Disables the deviation display / output.

Setting example: :CALC1:MATH:STAT ON  
 Sets to enables the primary parameter deviation display / output.

Response: {1|0}

Query example: :CALC1:MATH:STAT?

Response example: 1  
 The primary parameter deviation display / output is enabled.

Remarks: If the primary parameters or secondary parameters are changed with :CALCulate{1|2}:FORMat command, the deviation display / output of both primary and secondary parameters is disabled automatically. Set the primary parameters and secondary parameters prior to the deviation display / output.



**:CALCulate2:FORMat {Q|D|PHASe|X|B|RS|RP|G|LP|RDC|IMAGinary|REAL}**

**:CALCulate2:FORMat?**

Description: Sets the secondary parameters to be measured.

Parameters:

Q	Quarity factor (= 1/D)
D	Dissipation factor (= $\tan\delta$ )
PHASe	Phase angle of impedance ( $\theta$ , unit: degree)
X	Reactance $X_s$ expressed with series equivalent circuit (unit: $\Omega$ )
B	Susceptance $B_p$ expressed with parallel equivalent circuit (unit: siemens)
RS	Resistance $R_s$ expressed with series equivalent circuit (unit: $\Omega$ )
RP	Resistance $R_p$ expressed with parallel equivalent circuit (unit: $\Omega$ )
G	Conductance $G_p$ expressed with parallel equivalent circuit (unit: siemens)
LP	Inductance $L_p$ expressed with parallel equivalent circuit (unit: $\Omega$ )
RDC	DC resistance (unit: $\Omega$ )
IMAGinary	Imaginary part of immittance (X or B)
REAL	Real part of immittance (either $R_s$ , $G_p$ or $R_{dc}$ )

Note: Immittance is generic name of impedance and admittance.

Setting example: :CALC2:FORM D

Sets the secondary parameter to D.

Response: {Q|D|PHAS|X|B|RS|RP|G|LP|RDC|IMAG|REAL}

Query example: :CALC2:FORM?

Response example: D

The secondary parameter is dissipation factor D.

Remarks: Equivalent circuit assumed in the measurement of secondary parameters is as follows:

PHASe, D, Q, RDC	Not depend on the equivalent circuit.
X, RS	Series equivalent circuit
G, B, LP, RP	Parallel equivalent circuit

These parameters do not depend on [:SENSe]:FUNCTion[:ON] command and equivalent circuit setting.

IMAGinary, REAL

These parameters depend on [:SENSe]:FUNCTion[:ON] command and equivalent circuit setting. ☞ See the following table

[:SENSe]:FUNCTion[:ON]	IMAGinary	REAL
FIMPedance (Series equivalent circuit)	X	$R_s$ (= ESR)
FADMittance (Parallel equivalent circuit)	B	G
FIMPedance, FRESistance	X	$R_{dc}$
FADMittance, FRESistance	B	$R_{dc}$

The setting of equivalent circuit (series/parallel) and the setting of automatic selection of equivalent circuit do not affect the secondary parameter setting. However, the secondary parameters actually measured and displayed may vary since [:SENSe]:FUNCTion[:ON] command and equivalent circuit setting are interlocked.

**:CALCulate2:LIMit:CLEAr**

Description: Clears the secondary parameter limit comparison fail flag to “0” (pass).

Setting example: :CALC2:LIM:CLE

Clears the secondary parameter limit comparison fail flag.

**:CALCulate2:LIMit:FAIL?**

Description: Queries whether the secondary parameter limit comparison result is “fail” or not.

Response: {1|0}  
 1: Fail (LO or HI)  
 0: Pass (IN)

Query example: :CALC2:LIM:FAIL?

Response example: 0  
 The secondary parameter is “pass”.

**— — — Upper and lower limit values of secondary parameters in limit comparison — — —**

The upper and lower limit values used for the limit comparison function are common to those of secondary parameter for the comparator function (bin sorting). Either setting has same effect.

**:CALCulate2:LIMit:LOWer[:DATA] <lower limit value>****:CALCulate2:LIMit:LOWer[:DATA]?**

Description: Sets/queries the lower limit value of secondary parameters used for limit comparison.

Parameters: <lower limit value> {numeric value, range 0, ± (1E-16 to 9.99999E+11) }  
 MAX / MIN can be used.

Setting example: :CALC2:LIM:LOW 1.23456E-06  
 Sets the lower limit value of secondary parameters used for limit comparison to 1.23456μ.

Response: <lower limit value> {numeric value, format NR3}

Query example: :CALC2:LIM:LOW?

Response example: +1.23456E-06  
 The lower limit value of secondary parameters used for limit comparison is 1.23456μ.

**:CALCulate2:LIMit:LOWer:STATe {ON|OFF|1|0}****:CALCulate2:LIMit:LOWer:STATe?**

Description: Sets/queries whether the lower limit value is compared or not in the limit comparison of secondary parameters.

Parameters: {ON|1} Lower limit value is compared.  
 {OFF|0} Lower limit value is not compared (corresponding to No Limit of panel operation).

Setting example: :CALC2:LIM:LOW:STAT ON  
 Sets so that the lower limit value is compared in the secondary parameter limit comparison.

Response: {1|0}

Query example: :CALC2:LIM:LOW:STAT?

Response example: 1  
 The lower limit value is compared in the secondary parameter limit comparison.

**:CALCulate2:LIMit:STATe {ON|OFF|1|0}****:CALCulate2:LIMit:STATe?**

Description:	Sets/queries whether the limit comparison function of secondary parameter is used or not.
Parameters:	{ON   1} Enables the limit comparison function of secondary parameter. {OFF   0} Disables the limit comparison function of secondary parameter.
Setting example:	:CALC2:LIM:STAT ON Sets to enables the limit comparison function of secondary parameter.
Response:	{1   0}
Query example:	:CALC2:LIM:STAT?
Response example:	1
Remarks:	The limit comparison function of secondary parameter is enabled. When the secondary parameter limit comparison function is enabled, <ul style="list-style-type: none"> <li>• the comparator operation changes to the limit comparison, and</li> <li>• BIN2 - BIN14 sorting is not executed. (Bin sorting is restricted)</li> <li>• The comparator result is displayed on the panel, and also</li> <li>• the comparator result is output to the handler interface.</li> </ul> When the secondary parameter limit comparison function is disabled, the comparator function is set to OFF (disabled) if the primary parameter limit comparison is disabled.

**:CALCulate2:LIMit:UPPer[:DATA] <upper limit value>****:CALCulate2:LIMit:UPPer[:DATA]?**

Description:	Sets/queries the upper limit value of secondary parameters used for limit comparison.
Parameters:	<upper limit value> {numeric value, range 0, ± (1E-16 to 9.99999E+11) } MAX / MIN can be used.
Setting example:	:CALC2:LIM:UPP 12.3456E-06 Sets the upper limit value of secondary parameters used for limit comparison to 12.3456μ.
Response:	<upper limit value> {numeric value, format NR3}
Query example:	:CALC2:LIM:UPP?
Response example:	+1.23456E-05 The upper limit value of secondary parameters used for limit comparison is 1.23456E-05 (= 12.3456μ).

**:CALCulate2:LIMit:UPPer:STATe {ON|OFF|1|0}****:CALCulate2:LIMit:UPPer:STATe?**

Description: Sets/queries whether the upper limit value is compared or not in the limit comparison of secondary parameters.

Parameters: {ON|1} Upper limit value is compared.  
 {OFF|0} Upper limit value is not compared (corresponding to No Limit of panel operation).

Setting example: :CALC2:LIM:UPP:STAT ON  
 Sets so that the upper limit value is compared in the secondary parameter limit comparison.

Response: {1|0}

Query example: :CALC2:LIM:UPP:STAT?

Response example: 1  
 The upper limit value is compared in the secondary parameter limit comparison.

**:CALCulate2:MATH:EXPRession:NAME {DEV|PCNT}****:CALCulate2:MATH:EXPRession:NAME?**

Description: Sets/queries the deviation display format of secondary parameters. To display the deviation, set the deviation display format, and further set so that the deviation is displayed using :CALCulate2:MATH:STATe ON command.  
 Set the referenced value with :DATA[:DATA] command.

Parameters: DEV Deviation: Deviation from reference value (= measured value – reference value) is displayed.  
 PCNT Deviation %: Deviation (to reference value) is displayed with percent value.

Setting example: :CALC2:MATH:EXPR:NAME DEV  
 Sets to deviation the deviation display format of secondary parameters.

Response: {DEV|PCNT}

Query example: :CALC2:MATH:EXPR:NAME?

Response example: DEV  
 The deviation display format of secondary parameters is deviation.

**:CALCulate2:MATH:STATe {ON|OFF|1|0}****:CALCulate2:MATH:STATe?**

Description: Sets/queries whether the secondary parameter deviation display / output is executed or not.

Parameters: {ON|1} Enables the deviation display / output.  
 {OFF|0} Disables the deviation display / output.

Setting example: :CALC2:MATH:STAT OFF  
 Sets to disables the secondary parameter deviation display / output.

Response: {1|0}

Query example: :CALC2:MATH:STAT?

Response example: 0  
 The secondary parameter deviation display / output is disabled.

**:CALCulate3:MATH:STATe {ON|OFF|1|0}**

Description: Sets whether the current monitor is displayed or not.

Parameters: {ON|1} Sets auxiliary display to the voltage & current monitor.  
This setting is equivalent to :DISP:TEXT3 MON.  
{OFF|0} Stops the display on the voltage & current monitor.  
:DISP:TEXT3 STAT is set, provided that :DISP:TEXT3 is set to MON.  
No influence for others.

Setting example: :CALC3:MATH:STAT ON  
Sets auxiliary display to the voltage & current monitor.

**:CALCulate4:MATH:STATe {ON|OFF|1|0}**

Description: Sets whether the voltage monitor is displayed or not.

Parameters: {ON|1} Sets auxiliary display to the voltage & current monitor.  
This setting is equivalent to :DISP:TEXT3 MON.  
{OFF|0} Stops the display on the voltage & current monitor.  
:DISP:TEXT3 STAT is set, provided that :DISP:TEXT3 is set to MON.  
No influence for others.

Setting example: :CALC4:MATH:STAT ON  
Sets auxiliary display to the voltage & current monitor.

**:CALibration:CABLe <cable length>****:CALibration:CABLe?**

Description: Sets/queries the measurement cable length.

Parameters: <cable length> {numeric value, range 0, 1, 2, 4, unit: m}  
A numeric value is rounded to 0, 1, 2, or 4, whichever nearest.

Setting example: :CAL:CABL 1  
Sets the cable length to 1m.

Response: <cable length> {numeric value, format NR1}

Query example: :CAL:CABL?

Response example: +1  
The cable length is 1m.

**:DATA[:DATA] {REF1|REF2}, <reference value>****:DATA[:DATA]? {REF1|REF2|BUF1|BUF2|BUF3|IMON|VMON}**

Description: Sets reference value used when the deviation is displayed. It is common to the reference value of comparator.  
Or, queries reference value when the deviation is displayed, or measured data.

Parameters:

REF1	Sets/queries reference value for deviation display/comparison of primary parameters.
REF2	Sets/queries reference value for deviation display/comparison of secondary parameters.
BUF1	Queries the measured data buffer 1.
BUF2	Queries the measured data buffer 2.
BUF3	Queries the measured data buffer 3.
IMON	Queries the current monitored value.
VMON	Queries the voltage monitored value.
<reference value> REF1	{numeric value, range 0, $\pm(1E-16$ to $9.99999E+11)$ }
REF2	{numeric value, range 0, $\pm(1E-16$ to $9.99999E+11)$ }

In either case, MAX / MIN can be used.

The monitored value can be queried even if the monitored value is not displayed on the auxiliary display.

Setting example: :DATA REF1, 1.23456E-06  
Sets reference value of primary parameters to 1.23456E-06.

Response:

REF1	{numeric value, format NR3}
REF2	{numeric value, format NR3}
IMON	{numeric value, format NR3, range 0, $1E-10$ to $9.99999E-01$ , unit: Arms}
VMON	{numeric value, format NR3, range 0, $1E-05$ to $9.99999E+00$ , unit: Vrms}

Current and voltage monitored values are measured values. Normally, the output values are up to about 200mArms and 5Vrms.

## BUF1, BUF2, BUF3

<measured data 1>,<measured data 2>,<measured data 3>,...,<measured data n>

“n” is the measurement point number specified by “:DATA:POINTs” command.

The read data is deleted from the measured data buffer.

The parts not recorded are all measured data zero (for example, +0,+0.00000E+00,+0).

The content of <measured data m> is as follows (m: 1 to n).

<measurement status>, <measured data>

[ , {comparator's bin sorting result} | <limit comparison result> ]

<measurement status> {numeric value, format NR1, range see below}

0 No error

1 Either measurement error ERR, ALC error ALC Err, or correction error CORR Err

2 Contact failure

3 Other any errors

<measured value>

For BUF1 and BUF2, either <primary parameter measured value> or <secondary parameter measured value> set by :DATA:FEED command.

For BUF3, <primary parameter measured value> and <secondary parameter measured value>.

For data transfer format, ⚡ :FORMat[:DATA] command

<comparator's bin sorting result> {numeric value, format NR1, range see below}

For BUF1 and BUF2, the bin sorting result is output whichever the comparator function (bin sorting) is enabled or disabled.

For BUF3, the bin sorting result is output only when the comparator function (bin sorting) is enabled.

When bin extended function is disabled

0 OUT\_OF\_BINS

1 BIN1

2 BIN2

• •

9 BIN9

10 AUX\_BIN (S-NG)

11 Sorting failed

When bin extended function is enabled

0 OUT\_OF\_BINS

1 BIN1

2 BIN2

• •

9 BIN9

10 BIN10

11 BIN11

• •

14 BIN14

15 AUX\_BIN (S-NG)

16 Sorting failed

AUX\_BIN (S-NG): Output only when S-NG is used as auxiliary bin.

⚡ :CALCulate:COMPARator:AUXBin command

Sorting failed: Any error occurred or comparator function is disabled.

When the bin extended function is enabled, the range exceeding 10 has different meaning.

⚡ :CALCulate:COMPARator:EXTension[:STATe] command

## &lt;limit comparison result&gt;

When the primary parameter or secondary parameter limit comparison function is enabled, the limit comparison result is output regardless of the setting of comparator function (bin sorting). The bin sorting result of comparator is not output.

For BUF1 and BUF2, either <primary parameter comparison result> or <secondary parameter comparison result> set by :DATA:FEED command is output.

For BUF3, <primary parameter comparison result> and <secondary parameter comparison result> are output.

<{primary | secondary}parameter comparison result> {numeric value, format NR1, range see below}

- 0 Limit comparison function is disabled
- 1 IN (within the range of upper limit and lower limit)
- 2 HI (larger than upper limit)
- 4 LO (smaller than lower limit)

Query example1: :DATA? REF1

Response example1: +1.23456E-06

The reference value of primary parameter is 1.23456E-06.

Query example2: :DATA? BUF1

Response example2: Only one measured data is shown here as an example, when the comparator function is enabled.

+0,+1.23456E-06,+2

No measurement error, Measured value = 1.23456E-06, Comparator's bin sorting result = Bin 2

Query example3: :DATA? BUF3

Response example3: Only one measured data is shown here as an example, when the limit comparison function is enabled.

+0,+1.23456E-06,+1.43657E-03,+1,+2

No measurement error, Primary parameter 1.23456E-06, Secondary parameter 1.43657E-03, Primary parameter limit comparison IN, Secondary parameter limit comparison HI.



**:DATA:FEED {BUF1|BUF2},{"CALCulate1"|"CALCulate2"|""}}**

**:DATA:FEED? {BUF1|BUF2}**

Description: Sets/queries the measured data recorded in the measured data buffer 1 or measured data buffer 2. To record the measured data, specify additionally the :DATA:FEED:CONT command so as to record the measured data.

Parameters:

BUF1	Sets/queries the measured data buffer 1.
BUF2	Sets/queries the measured data buffer 2.
"CALCulate1"	Records the measured data of primary parameter.
"CALCulate2"	Records the measured data of secondary parameter.
""	Both measured data are not recorded.

Double quotation (") is required to indicate the measured data to be recorded.

Setting example: :DATA:FEED BUF1,"CALC1"  
Sets so that the measured data of primary parameter is recorded in the measured data buffer 1.

Response: {"CALC1"|"CALC2"|""}}

Query example: :DATA:FEED? BUF1

Response example: "CALC1"

The measured data recorded in the measured data buffer 1 is primary parameter.

**:DATA:FEED:CONTRol {BUF1|BUF2|BUF3},{ALWays|NEVer}**

**:DATA:FEED:CONTRol? {BUF1|BUF2|BUF3}**

Description: Sets/queries whether the measured data is recorded in the measured data buffer.

Parameters:

BUF1	Sets/queries the measured data buffer 1.
BUF2	Sets/queries the measured data buffer 2.
BUF3	Sets/queries the measured data buffer 3.
ALWays	The measured data is recorded every measurement.
NEVer	The measured data is not recorded.

Setting example: :DATA:FEED:CONT BUF1,ALW  
Sets so that the measured data is recorded in the measured data buffer 1.

Response: {ALW|NEV}

Query example: :DATA:FEED:CONT? BUF1

Response example: ALW

The measured data buffer 1 is set so as to record the measured data.

Remarks: About the measured data to be recorded

For details  :DATA[:DATA]? :DATA:FEED

**:DATA:POINTS {BUF1|BUF2|BUF3},<buffer size>****:DATA:POINTS? {BUF1|BUF2|BUF3}**

Description: Sets/queries virtual size (number of measurement points) of the measured data buffer.  
If set, the specified measured data buffer is cleared.

Parameters: BUF1 Sets/queries the measured data buffer 1.  
BUF2 Sets/queries the measured data buffer 2.  
BUF3 Sets/queries the measured data buffer 3.  
<buffer size> Expressed with the number of measurement points.  
MAX / MIN can be used.

BUF1, BUF2 {numeric value, range 1 - 200}

BUF3 {numeric value, range 1 - 1000}

Setting example: :DATA:POIN BUF1,100  
Sets virtual size of measured data buffer 1 to 100.

Response: BUF1, BUF2 {numeric value, format NR1}  
BUF3 {numeric value, format NR1}

Query example: :DATA:POIN? BUF1

Response example: +100  
Virtual size of measured data buffer 1 is 100.

Remarks: The measured data buffer is a ring buffer. After it becomes physically full, the data in the lead position is overwritten. When the measured data are recorded by the amount of virtual size, the status that indicates "full" is set. ••• **5.7.4 Operation Status**

For :DATA[:DATA]? {BUF1 | BUF2 | BUF3}, the data by the amount of virtual size are transmitted starting from the lead position, whichever the buffer is full or not.

**:DISPlay[:WINDow][:STATe] <display permission>**

Description: This command is accepted but it does nothing.

Parameters: <display permission > {ON | OFF | 1 | 0}

Setting example: :DISP OFF  
Nothing is done. The measured result is always displayed.

**:DISPlay[:WINDow]:TEXT1:DIGit <display digits>**

Description: This command is accepted but it does nothing.

Parameters: < display digits > {numeric value, range 3 - 6}  
Out of range causes an error.

Setting example: :DISP:TEXT1:DIG 4  
Nothing is done. The measured value is always displayed with the maximum of digits.

**:DISPlay[:WINDow]:TEXT1:PAGE <displayed data>**

Description: This command is accepted but it does nothing.

Parameters: < displayed data>{numeric value, range 1 or 2}  
Out of range causes an error.

Setting example: :DISP:TEXT1:PAGE 2  
Nothing is done.  
The comparator result and limit comparison result are displayed simultaneously with the measured value.

**:DISPlay[:WINDow]:TEXT2:PAGE <display item>**

Description:	Sets auxiliary display items. Converted into :DISP:TEXT3 command and executed.
Parameters:	<display item> {numeric value, range 1 - 8} Out of range causes an error.
	2 Measurement condition status
	4 Lower limit value and upper limit value of BIN1 (primary parameter)
	5 Lower limit value and upper limit value of secondary parameter
	7 Voltage & current monitor
	1, 3, 6, 8 Content of auxiliary display is not changed but previous display item is retained.
Setting example:	:DISP:TEXT2:PAGE 4 Sets so as to display the lower limit value and upper limit value of BIN1 (primary parameter).

**:DISPlay[:WINDow]:TEXT3[:PAGE] {STATus|BIN1|..|BIN14|SLIMit|REFerence|MONitor}****:DISPlay[:WINDow]:TEXT3[:PAGE]?**

Description:	Sets/queries auxiliary display item.
Parameters:	STATus Measurement condition status
	BIN1..BIN14 Lower limit value and upper limit value of the specified bin of primary parameter
	SLIMit Lower limit value and upper limit value of secondary parameter (Secondary LIMit)
	REFerence Reference values of primary parameter and secondary parameter (for deviation)
	MONitor Current and voltage monitored values
Setting example:	:DISP:TEXT3 MON Sets auxiliary display item to the voltage & current monitor.
Response:	{STAT BIN1 .. BIN14 SLIM REF MON}
Query example:	:DISP:TEXT3?
Response example:	MON Auxiliary display item is the voltage & current monitor.
Remarks:	To display the lower limit value and upper limit value of primary parameter used for the limit comparison function, specify the BIN1. Do not specify a bin by mistake which is not used for the limit comparison.

**:FETCh?**

Description: Queries the latest measured data.  
For the data transfer format, see :FORMat[:DATA] command.

Response: When comparator function and limit comparison function are both disabled  
 <measurement status>,<primary parameter measured value>,<secondary parameter measured value>

When comparator function (bin sorting) is enabled  
 <measurement status>,<primary parameter measured value>,<secondary parameter measured value>,<comparator's bin sorting result>

When limit comparison function is enabled  
 <measurement status>,<primary parameter measured value>,<secondary parameter measured value>,<limit comparison result>

The limit comparison result is output regardless of the setting of comparator function (bin sorting). The bin sorting result of comparator is not output.

The contents of respective data are as follows.

<measurement status>

- |   |   |
|---|---|
| 0 | No error  |
| 1 | Either measurement error ERR, ALC error ALC Err, or correction error CORR Err |
| 2 | Contact failure   |
| 3 | Other any errors  |

<primary parameter measured value> and <secondary parameter measured value>

{numeric value, format NR3, range  $\pm 9.99999E+11$ }

<comparator's bin sorting result>

When bin extended function is disabled		When bin extended function is enabled	
0	OUT_OF_BINS	0	OUT_OF_BINS
1	BIN1	1	BIN1
2	BIN2	2	BIN2
	• •		• •
9	BIN9	9	BIN9
10	AUX_BIN (S-NG)	10	BIN10
11	Sorting failed	11	BIN11
			• •
		14	BIN14
		15	AUX_BIN (S-NG)
		16	Sorting failed

AUX\_BIN (S-NG): Output only when S-NG is used as auxiliary bin.

☞ :CALCulate:COMParator:AUXBin command

Sorting failed: Any error occurred or comparator function is disabled.

When the bin extended function is enabled, the range exceeding 10 has different meaning.

☞ :CALCulate:COMParator:EXTension[:STATE] command

<limit comparison result>

[,<primary parameter comparison result>] [,<secondary parameter comparison result>]

Only the comparison result of the parameter that enabled the limit comparison function is output.

- 0 Limit comparison function is disabled
- 1 IN (within the range of upper limit and lower limit)
- 2 HI (larger than upper limit)
- 4 LO (smaller than lower limit)

Query example: :FETC?

Response example: +0,+3.14159E-06,+1.20000E-02,+2

(When comparator function enabled, C-D measurement, deviation not displayed, ASCII format)

Measurement status = 0 (no error), C = 3.14159E-06 (3.14159 $\mu$ F),

D = 1.20000E-02 (0.01200), Comparator's bin sorting result = 2 (BIN2)

Remarks:

When the measurement status is other than 0 (error), the measured value of primary parameter and secondary parameter is 9.9E+37, and the comparator result is 11 (16 when bin extended function is enabled). When the measurement status is 1 or 3, the limit comparison result is 2 (HI).

**:FORMat[:DATA] {ASCii|REAL[,64]|PACKed}****:FORMat[:DATA]?**

Description:	Sets/queries the data transfer format. The set data transfer format is applied to the response message of :DATA[:DATA]?, :FETCh?, or :READ? query.
Parameters:	ASCii      ASCII format (NR1/NR2/NR3, character string) REAL[ ,64]    Real number format (double-precision floating point, 64-bit binary) PACKed      Packed format (display digit fixed ASCII format)
Setting example:	:FORM ASC Sets the data transfer format to ASCII.
Response:	{ASC REAL PACK}
Query example:	:FORM?
Response example:	ASC The data transfer format is ASCII.

**■ ASCII format**

The data is expressed with characters, and respective characters are transferred with ASCII codes.

Depending on the parameter, a numeric value is transferred in either of the following formats:

NR1	Integer (ex. : +123)
NR2	Explicit decimal point format not having exponent (ex. : +0.12345)
NR3	Explicit decimal point format having exponent (ex. : +123456E-07)

When multiple numeric values are transferred, numeric values are separated with a comma (.). At the end, a message terminator (for instance, LF^EOI) is added.

**■ Real number format**

The data is transferred in the 64-bit double-precision floating point format in accordance with IEEE 754.

When multiple numeric values are transferred, all data are expressed in the double-precision floating point format.

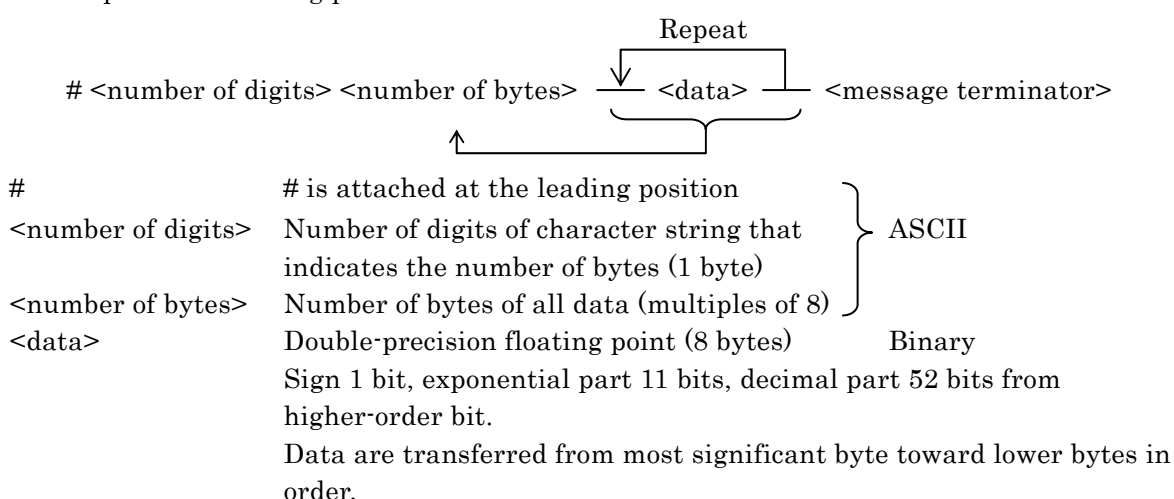

When multiple numeric data are transferred, they are fed successively without separating them with a comma (.).

At the end, a message terminator is added. Note that a message terminator is added at the end, different from the definite length arbitrary block specified by the IEEE 488.2 Standard.

### ■ Packed format

The measured value is transferred in the ASCII character string format in which the display digits are fixed. Numeric value is transferred with definite length ASCII character string in which an exponential part and decimal point position are fixed.

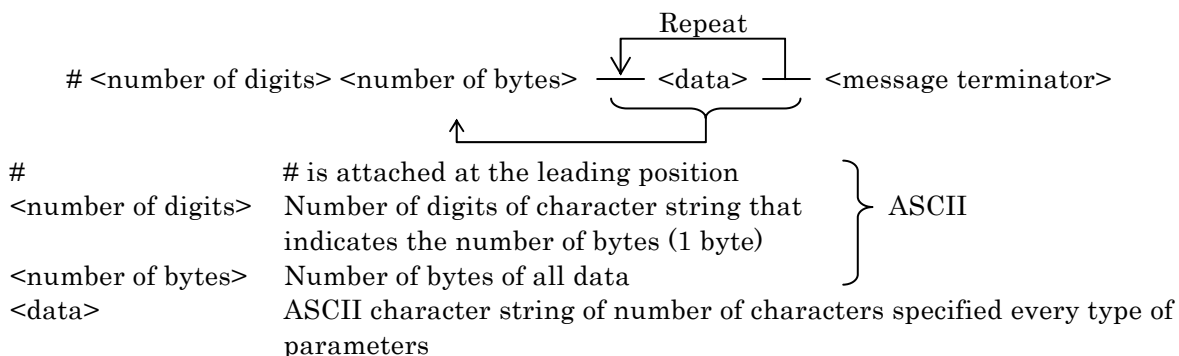

When multiple numeric data are transferred, they are fed successively without separating them with a comma (.). At the end, a message terminator (LF^EOI) is added. Note that a message terminator (LF^EOI) is added at the end, different from the definite length arbitrary block specified by the IEEE 488.2 Standard.

Each <data> is expressed as follows:

<measurement status>, <primary parameter comparison result>, <secondary parameter comparison result>

Number of characters 1  
Content 1-digit integer indicating respective results 0 - 8

<comparator's bin sorting result>

Number of characters 2  
Content 2-digit integer indicating <comparator's bin sorting result> 00 - 16

<primary parameter measured value>, <secondary parameter measured value>

Number of characters 10  
Content The following three items are successively placed without separating them with a comma (,), space, or decimal point.  
Sign (1 character {+|-})  
Count value indicating the magnitude of measured value (6 characters 000000 - 999999)  
Exponential part (3 characters -99 to +00 to +99)  
Measured value = Sign factor {+1|-1} × Count value × ("exponential part" power of 10)

Specifying the digit For the display digits (decimal point position and exponential part) of data such as L, C and R, specify the reference value for deviation measurement. For example, if the reference value for deviation measurement is set to 12m (12.0000m), the measured value 00.0000m - 99.9999m is converted into count value 000000 - 999999 and exponential part -07, and output. The deviation is also converted similarly.

Deviation % ±999.999% is output as follows:

sign {+|-}, count value 000000 - 999999, exponential part -03

Phase θ ±180.000 is output as follows:

sign {+|-}, count value 000000 - 180000, exponential part -03

The count value exceeding 999999 is all converted into 999999. At this time, the sign is retained.

**:INITiate:CONTinuous {ON|OFF|1|0}****:INITiate:CONTinuous?**

Description:	Sets/queries whether the trigger system continuous initiation is enabled or disabled. If enabled, when the measurement finished and the trigger system becomes idle state, the device goes in the trigger waiting state automatically. If disabled, the device remains in idle state.
Setting example:	:INIT:CONT ON Enables the trigger system continuous initiation.
Response:	{1 0}
Query example:	:INIT:CONT?
Response example:	1 The trigger system continuous initiation is enabled.
Remarks:	The continuous initiation is enabled when the power is turned on. It is also enabled when the initialization is executed by panel operation. The continuous initiation is disabled by the *RST command.

**:INITiate[:IMMediate]**

Description:	The device goes in the trigger waiting state when the trigger system is in idle state.
Setting example:	:INIT Sets the trigger waiting state.

**:READ?**

Description:	The measurement is stopped and the device goes in the trigger waiting state whichever state the device is placed in at that time. After that, when the trigger is applied and one-time measurement finished, the measured data is read. After :READ? query is transmitted, receive the measured data. Upon completion of the measurement, newly measured data can be received.
Response:	<measurement status>, <primary parameter measured value>, <secondary parameter measured value> [, { <comparator's bin sorting result>   <limit comparison result> } ]
Query example:	:READ?
Response example:	+0,+3.1415E-06,+1.20000,+2 The response message is same as :FETCh? query. For details, see the description of :FETCh? query.
Remarks:	Since the :READ? query itself does not apply the trigger, the trigger is required additionally. Once the :READ? query is executed, the device does not execute the next command until the measured data is placed in the output queue. For this reason, the trigger is not executed even if the trigger source is set to BUS and an attempt is made to apply the trigger by remote control immediately after the :READ? query, causing the device to be hung up in the trigger waiting state. The trigger waiting state can be reset by the device clear.



**[[:SENSe]:AVERage:COUNT <count>****[[:SENSe]:AVERage:COUNT?**

Description:	Sets/queries the measurement averaging count. The signal acquisition time is averaging-count multiples of the base value determined by the measurement speed. To execute the averaging, enable the averaging function by [[:SENSe]:AVERage[:STATe] command additionally.	
Parameters:	<count> {numeric value, range 1 - 256}	MAX / MIN can be used.
Setting example:	:AVER:COUN 100 Sets the averaging count to 100.	
Response:	{numeric value, format NR1}	
Query example:	:AVER:COUN?	
Response example:	+100 The averaging count is 100.	

**[[:SENSe]:AVERage[:STATe] {ON|OFF|1|0}****[[:SENSe]:AVERage[:STATe]?**

Description:	Sets/queries whether the averaging is executed or not. Set the averaging count additionally with [[:SENSe]:AVERage:COUNT command.	
Parameters:	{ON 1}	Enables the averaging function.
	{OFF 0}	Disables the averaging function.
Setting example:	:AVER ON Sets so as to enable the averaging function.	
Response:	{1 0}	
Query example:	:AVER?	
Response example:	1 The averaging function is enabled.	
Remarks:	If the averaging count is set to 2 or larger value by the panel operation, the averaging function is automatically enabled. If the averaging count is set to 1 by the panel operation, the averaging function is automatically disabled.	

**[[:SENSe]:CORRection:CKIT:STANdard1:FORMat {GB|CPG}****[[:SENSe]:CORRection:CKIT:STANdard1:FORMat?**

Description: Sets/queries the format of OPEN correction value.

Parameters: GB G,B (conductance G and susceptance B of parallel equivalent circuit)  
 CPG Cp,G (C and G of parallel equivalent circuit)

Setting example: :CORR:CKIT:STAN1:FORM GB  
 Sets the format of OPEN correction value to G,B.

Response: {GB|CPG}

Query example: :CORR:CKIT:STAN1:FORM?

Response example: GB  
 The format of OPEN correction value is G,B.

**[[:SENSe]:CORRection:CKIT:STANdard2:FORMat {RX|LSRS}****[[:SENSe]:CORRection:CKIT:STANdard2:FORMat?**

Description: Sets/queries the format of SHORT correction value.

Parameters: RX Rs,X (resistance R and reactance X of series equivalent circuit)  
 LSRS Ls,Rs (inductance L and R of series equivalent circuit)

Setting example: :CORR:CKIT:STAN2:FORM RX  
 Sets the format of SHORT correction value to Rs,X.

Response: {RX|LSRS}

Query example: :CORR:CKIT:STAN2:FORM?

Response example: RX  
 The format of SHORT correction value is Rs,X.

**[[:SENSe]:CORRection:CKIT:STANdard3 <primary parameter>,<secondary parameter>****[[:SENSe]:CORRection:CKIT:STANdard3?**

Description:	Sets/queries standard value for LOAD correction. Set the format of standard value additionally with [:SENSe]:CORRection:CKIT:STANdard3:FORMat command.
Parameters:	<primary parameter> {numeric value, range 0, $\pm(1E-16 - 9.99999E+11)$ } <Secondary parameter> {numeric value, range 0, $\pm(1E-16 - 9.99999E+11)$ }  Actually set value follows the format of standard value and it is rounded to the range same as set by the panel operation. The unit follows the format of standard value.
Setting example:	:CORR:CKIT:STAN3 12.3456E-06, 0.01234 Sets standard value for LOAD correction to $C_s = 12.3456\mu\text{F}$ , $D = 0.01234$ . (when the format is CSD)
Response:	<primary parameter>,<secondary parameter> {numeric value, format NR3}
Query example:	:CORR:CKIT:STAN3?
Response example:	+1.23456E-05,+1.23400E-02 Standard value for LOAD correction is $C_s = 1.23456E-05 \text{ F}$ ( $12.3456\mu\text{F}$ ), $D = 1.23400E-02$ (0.01234). (when the format is CSD)

**[[:SENSe]:CORRection:CKIT:STANdard3:FORMat {CPD|CSD|RCP|RLS|RX|ZPH}****[[:SENSe]:CORRection:CKIT:STANdard3:FORMat?**

Description:	Sets/queries the format of standard value for LOAD correction and LOAD correction value.
Parameters:	CPD Cp, D (in either case, the order is primary parameter and secondary parameter)  CSD Cs, D RCP Rp, Cp RLS Rs, Ls RX Rs, X ZPH Z, $\theta$
Setting example:	:CORR:CKIT:STAN3:FORM CSD Sets the format of standard value for LOAD correction and LOAD correction value to Cs,D.
Response:	{CPD   CSD   RCP   RLS   RX   ZPH}
Query example:	:CORR:CKIT:STAN3:FORM?
Response example:	CSD The format of standard value for LOAD correction and LOAD correction value is Cs,D.

**[[:SENSe]:CORRection:COLLect[:ACQuire] {STANdard1|STANdard2|STANdard3}**

Description:	Measures the specified correction value (either OPEN, SHORT, or LOAD). If a correction data is obtained successfully, a setting is made automatically so as to execute that correction.
Parameters:	STANdard1 Correction value for OPEN correction STANdard2 Correction value for SHORT correction STANdard3 Correction value for LOAD correction
Setting example:	:CORR:COLL STAN2 Measures a correction value for SHORT correction and enables the SHORT correction.
Remarks:	To execute the LOAD correction correctly, not only the LOAD correction value, but also the OPEN correction value and SHORT correction value must be measured in advance. Any measurement order is acceptable. As this command is an overlap command, if such program is made that *OPC? query is added at the end so as to receive the response message 1, the device can wait for the completion of correction. Example :CORR:COLL STAN2;*OPC? Or, *WAI command may be added to make the device wait to execute following commands until the completion of correction. Example :CORR:COLL STAN2;*WAI

**[[:SENSe]:CORRection:COLLect:METhod {REFL2|REFL3}****[[:SENSe]:CORRection:COLLect:METhod?**

Description:	Sets/queries correction items to be operated by [:SENSe]:CORRection[:STATe] command.
Parameters:	REFL2 OPEN correction and SHORT correction REFL3 OPEN correction, SHORT correction, and LOAD correction
Setting example:	:CORR:COLL:METh REFL3 OPEN correction, SHORT correction, and LOAD correction are to be operated.
Response:	{REFL2   REFL3}
Query example:	:CORR:COLL:METh?
Response example:	REFL3 The operation targets are OPEN correction, SHORT correction, and LOAD correction.
Remarks:	If REFL2 is set, the LOAD correction is disabled.

**[[:SENSe]:CORRection:DATA {STANdard1|STANdard2|STANdard3} ,  
 <correction primary parameter>, <correction secondary parameter>**

**[[:SENSe]:CORRection:DATA? {STANdard1|STANdard2|STANdard3}**

- Description:** Sets/queries spot OPEN correction value, spot SHORT correction value, and LOAD correction value at current frequency.  
 Set the format of correction value with  
 [SENSe]:CORRection:CKIT:STANdard{1 | 2 | 3}:FORMat command.
- Parameters:**
- |                                  |  |
|----------------------------------|--|
| STANdard1                        | Sets/queries spot OPEN correction value.         |
| STANdard2                        | Sets/queries spot SHORT correction value         |
| STANdard3                        | Sets/queries LOAD correction value.              |
| <correction primary parameter>   | {numeric value, range 0,±(1E-16 - 9.99999E+11) } |
| <correction secondary parameter> | {numeric value, range 0,±(1E-16 - 9.99999E+11) } |
- Actually set value follows the format of correction value and it is rounded to the range same as set by the panel operation. The unit follows the format of correction value.
- Setting example:** :CORR:DATA STAN2, 15.3E-03, 2.35E-03  
 Sets spot SHORT correction value to  $R_s = 15.3 \text{ m}\Omega$ ,  $X = 2.35 \text{ m}\Omega$ .  
 (when the format of correction value is RX)
- Response:** <correction primary parameter>, <correction secondary parameter>  
 {numeric value, format NR3}
- Query example:** :CORR:DATA? STAN2
- Response example:** +1.53000E-02,+2.3500E-03  
 Spot SHORT correction value is  $R_s = 1.53000\text{E-}02 \Omega$  (15.3 m $\Omega$ ),  
 $X = 2.3500\text{E-}03 \Omega$  (2.35 m $\Omega$ ). (when the format of correction value is RX)

**[[:SENSe]:CORRection:LIMit:LOW <lower limit frequency>****[[:SENSe]:CORRection:LIMit:LOW?**

Description:	Sets/queries the lower limit frequency when OPEN correction value and SHORT correction value are measured in full frequency range. The upper limit frequency is fixed to 100kHz.
Parameters:	<lower limit frequency> {numeric value, range 0.001 - 1000, resolution 2 digits (1mHz when <10mHz), unit: Hz} Initial value = 40Hz Suffix M ( $10^{-3}$ ) / K ( $10^3$ ), unit HZ can be used. Example: 1M (= 0.001), 1KHZ (= 1000).
Setting example:	:CORR:LIM:LOW 10 Sets the lower limit frequency of correction to 10Hz.
Response:	<lower limit frequency> {numeric value, format NR3}
Query example:	:CORR:LIM:LOW?
Response example:	+1.00000E+01 The lower limit frequency of correction is 10Hz.
Remarks:	Since it takes at least one period of signal for measurement at one frequency point, if the lower limit frequency is lowered to 1Hz or less, it will take much more time for correction. It is better to raise the lower limit frequency when the measurement is executed with high frequencies only. For the frequencies that measure correction values directly, see "3.5.6.7 OPEN Correction". Correction values for DC resistance measurement are measured regardless of this setting.

**[[:SENSe]:CORRection:LOAD[:STATe] {ON|OFF|1|0}****[[:SENSe]:CORRection:LOAD[:STATe]?**

Description:	Sets/queries whether LOAD correction is executed or not.
Parameters:	{ON   1} Enables the LOAD correction. {OFF   0} Disables the LOAD correction.
Setting example:	:CORR:LOAD ON Sets so as to enable the LOAD correction.
Response:	{1   0}
Query example:	:CORR:LOAD?
Response example:	1 The LOAD correction is enabled.
Remarks:	When the LOAD correction is enabled, the OPEN correction and SHORT correction are also enabled at the same time.

**[[:SENSe]:CORRection:OPEN[:STATe] {ON|OFF|1|0}****[[:SENSe]:CORRection:OPEN[:STATe]?**

Description: Sets/queries whether OPEN correction is executed or not.

Parameters: {ON|1} Enables the OPEN correction.  
 {OFF|0} Disables the OPEN correction.

Setting example: :CORR:OPEN ON  
 Sets so as to enable the OPEN correction.

Response: {1|0}

Query example: :CORR:OPEN?

Response example: 1  
 The OPEN correction is enabled.

**[[:SENSe]:CORRection:SHORT[:STATe] {ON|OFF|1|0}****[[:SENSe]:CORRection:SHORT[:STATe]?**

Description: Sets/queries whether SHORT correction is executed or not.

Parameters: {ON|1} Enables the SHORT correction.  
 {OFF|0} Disables the SHORT correction.

Setting example: :CORR:SHOR ON  
 Sets so as to enable the SHORT correction.

Response: {1|0}

Query example: :CORR:SHOR?

Response example: 1  
 The SHORT correction is enabled.

**[[:SENSe]:CORRection:SPOT[:STATe] {ON|OFF|1|0}****[[:SENSe]:CORRection:SPOT[:STATe]?**

Description: Sets/queries whether the OPEN correction and SHORT correction are executed with current one frequency only or in full frequency range.

Parameters: {ON|1} Enables the SPOT correction.  
 Correction is executed with current frequency only.  
 {OFF|0} Disables the SPOT correction.  
 Correction is executed in full frequency range.

Setting example: :CORR:SPOT ON  
 Sets so as to enable the SPOT correction.

Response: {1|0}

Query example: :CORR:SPOT?

Response example: 1  
 The SPOT correction is enabled.

Remarks: It will be better to enable SPOT correction when the LOAD correction is executed.  
 If the frequency is changed when the setting has been made so that the correction is executed with current frequency only, the OPEN, SHORT, and LOAD corrections are all disabled automatically.

**[[:SENSe]:CORRection[:STATe] {ON|OFF|1|0}**

Description:	Sets whether the correction is executed or not to the correction items specified by [:SENSe]:CORRection:COLLect:METhod command.
Parameters:	{ON 1} Enables target correction items. {OFF 0} Disables all the OPEN, SHORT, and LOAD corrections.
Setting example:	:CORR ON Enables target correction items.

**[[:SENSe][:FIMPedance]:APERture[:MODE] {SHORT|MEDIum|LONG|RAPid|FAST|SLOW|VSLOW|<measurement time>}****[[:SENSe][:FIMPedance]:APERture[:MODE]?**

Description:	Sets/queries the measurement time or measurement speed.
Parameters:	RAPid Sets measurement time to shortest (/ measurement speed to fastest). {SHORT FAST} Sets measurement time to short (/ measurement speed to fast). MEDIum Sets measurement time or measurement speed to standard value. {LONG SLOW} Sets measurement time to long (/ measurement speed to slow). VSLOW Sets measurement time to longest (/ measurement speed to lowest).

For concrete measurement time,  **“3.5.6.5 Measurement Speed”**

Setting example:	:APER MED Sets measurement time (/ measurement speed) to standard.
Response:	{RAP SHOR MED LONG VSLO}
Query example:	:APER?
Response example:	MED
Remarks:	The measurement time (/ measurement speed) is standard. The following measurement time can also be used as a parameter. <measurement time> {numeric value, range either 0.025, 0.065, or 0.5, unit: s} Suffix M (10 <sup>-3</sup> ), unit S can be used. Example: 25MS (= 0.025) However, actual measurement time will be different from the specified value since the measurement time is rounded to 0.025, 0.065 or 0.5 whichever nearest, and then it is converted into SHORT, MEDIum, or LONG.



**[[:SENSe][:FIMPedance]:CONTact:VERify {ON|OFF|1|0}****[[:SENSe][:FIMPedance]:CONTact:VERify?**

Description: Sets/queries whether the contact check is used or not.

Parameters: {ON|1} Enables the contact check function.  
 {OFF|0} Disables the contact check function.

Setting example: :CONT:VER ON  
 Sets so as to enable the contact check.

Response: {1|0}

Query example: :CONT:VER?

Response example: 1

Remarks: The contact check is enabled.  
 The contact check can be used for the **ZM2372** only.  
 An error will occur for the **ZM2371**.

**[[:SENSe][:FIMPedance]:CONTact:RVERify {ON|OFF|1|0}****[[:SENSe][:FIMPedance]:CONTact:RVERify?**

Description: Sets/queries whether real time check is used or not when the contact check is executed.

Parameters: {ON|1} Enables the real time check.  
 {OFF|0} Disables the real time check.

Setting example: :CONT:RVER ON  
 Sets so as to enable the real time check.

Response: {1|0}

Query example: :CONT:RVER?

Response example: 1

Remarks: The real time check is enabled.  
 The contact check can be used for the **ZM2372** only.  
 An error will occur for the **ZM2371**.

**[[:SENSe]:[:FIMPedance]:RANGe:AUTO {ON|OFF|1|0}****[[:SENSe]:[:FIMPedance]:RANGe:AUTO?**

Description: Sets/queries automatic switching of measurement range.

Parameters: {ON|1} Enables automatic switching of measurement range.  
 {OFF|0} Disables automatic switching of measurement range, and fixes the range (HOLD).

Setting example: :RANG:AUTO ON  
 Sets so as to enable automatic switching of measurement range.

Response: {1|0}

Query example: :RANG:AUTO?

Response example: 1  
 Automatic switching of measurement range is enabled.

Remarks: Automatic switching of measurement range is automatically disabled if specific range is set by panel operation or remote control.

**[[:SENSe]:[:FIMPedance]:RANGe[:UPPer] <range>****[[:SENSe]:[:FIMPedance]:RANGe[:UPPer]?**

Description: Sets/queries the measurement range. The range is specified in impedance.

Parameters: <range>  
 {numeric value, range 100E-3|1|10|100|1E+3|10E+3|100E+3|1E+6, unit:  $\Omega$ }.  
 As suffix, M ( $10^{-3}$ ), K ( $10^{+3}$ ), MEG ( $10^{+6}$ ) can be used.  
 As unit, OHM can be used. MAX / MIN can be used.  
 Parameter example: 10K (=  $10E+3$ ), 100OHM (= 100).  
 If an out-of-range value is set, it becomes minimum or maximum value.  
 If an arbitrary value is given, the range suitable for measuring that value is set.

Range	Measurement range
$1M\Omega \leq \text{Parameter}$	$1M\Omega$
$100k\Omega \leq \text{Parameter} < 1M\Omega$	$100k\Omega$
$10k\Omega \leq \text{Parameter} < 100k\Omega$	$10k\Omega$
$1k\Omega \leq \text{Parameter} < 10k\Omega$	$1k\Omega$
$10\Omega < \text{Parameter} < 1k\Omega$	$100\Omega$
$1\Omega < \text{Parameter} \leq 10\Omega$	$10\Omega$
$100m\Omega < \text{Parameter} \leq 1\Omega$	$1\Omega$
$\text{Parameter} \leq 100m\Omega$	$100m\Omega$

Setting example: :RANG 10E+3  
 Sets the measurement range to 10k $\Omega$ .

Response: {numeric value, format NR3}

Query example: :RANG?

Response example: +1.00000E+04  
 The measurement range is 1.00000E+04  $\Omega$  (10k $\Omega$ ).

**[[:SENSe]:FRESistance:RANGe:AUTO {ON|OFF|1|0}****[[:SENSe]:FRESistance:RANGe:AUTO?**

Description:	Sets/queries automatic switching of DC resistance measurement range.	
Parameters:	{ON   1}	Enables automatic switching of DC resistance measurement range.
	{OFF   0}	Disables automatic switching of DC resistance measurement range, and fixes the DC resistance measurement range (HOLD).
Setting example:	:FRES:RANG:AUTO ON Sets so as to enable automatic switching of DC resistance measurement range.	
Response:	{1   0}	
Query example:	:FRES:RANG:AUTO?	
Response example:	1 Automatic switching of DC resistance measurement range is enabled.	

**[[:SENSe]:FRESistance:RANGe[:UPPer] <range>****[[:SENSe]:FRESistance:RANGe[:UPPer]?**

Description:	Sets/queries the DC resistance measurement range.	
Parameters:	<range> {numeric value, range 100E-3   1   10   100   1E+3   10E+3   100E+3   1E+6, unit: $\Omega$ }. Parameter specifying method is same as that for the measurement range of AC impedance. For details  [:SENSe][:FIMPedance]:RANGe[:UPPer]	
Setting example:	:FRES:RANG 100E-1 Sets the measurement range to 100m $\Omega$ .	
Response:	{numeric value, format NR3}	
Query example:	:FRES:RANG?	
Response example:	+1.00000E-01 The DC resistance measurement range is 1.00000E-01 $\Omega$ (100m $\Omega$ ).	
Remarks:	Automatic switching of DC resistance measurement range is automatically disabled if specific DC resistance measurement range is set. The DC resistance measurement range cannot be specified or fixed from the panel.	

**[[:SENSe]:FUNcTION:CONCurent {ON|OFF|1|0}****[[:SENSe]:FUNcTION:CONCurent?**

Description:	Sets/queries how many measurement functions, two or only one, are specified. The measurement function are specified with [:SENSe]:FUNcTION[:ON] command.
Parameters:	{ON 1} Specifies two measurement functions. {OFF 0} Specifies only one measurement function. (Initial value, *RST)
Setting example:	:FUNC:CONC ON Sets so as to specify two measurement functions.
Response:	{1 0}
Query example:	:FUNC:CONC?
Response example:	1 A setting is made so as to specify two measurement functions.

**[[:SENSe]:FUNcTION[:ON] <measurement function>****[[:SENSe]:FUNcTION[:ON]?**

Description:	Sets/queries the measurement functions. Set in advance the number of measurement functions to be specified with [:SENSe]:FUNcTION:CONCurent command.												
Parameters:	1) When only one measurement function is specified <table> <thead> <tr> <th>&lt;measurement function&gt;</th> <th>&lt;description&gt;</th> </tr> </thead> <tbody> <tr> <td>"FIMPedance"</td> <td>Impedance measurement (series equivalent circuit)</td> </tr> <tr> <td>"FADMittance"</td> <td>Admittance measurement (parallel equivalent circuit)</td> </tr> </tbody> </table> 2) When two measurement functions are specified <table> <thead> <tr> <th>&lt;measurement function&gt;</th> <th>&lt;description&gt;</th> </tr> </thead> <tbody> <tr> <td>"FIMPedance","FRESistance"</td> <td>Impedance measurement (series equivalent circuit) and DC resistance measurement</td> </tr> <tr> <td>"FADMittance","FRESistance"</td> <td>Admittance measurement (parallel equivalent circuit) and DC resistance measurement</td> </tr> </tbody> </table>	<measurement function>	<description>	"FIMPedance"	Impedance measurement (series equivalent circuit)	"FADMittance"	Admittance measurement (parallel equivalent circuit)	<measurement function>	<description>	"FIMPedance","FRESistance"	Impedance measurement (series equivalent circuit) and DC resistance measurement	"FADMittance","FRESistance"	Admittance measurement (parallel equivalent circuit) and DC resistance measurement
<measurement function>	<description>												
"FIMPedance"	Impedance measurement (series equivalent circuit)												
"FADMittance"	Admittance measurement (parallel equivalent circuit)												
<measurement function>	<description>												
"FIMPedance","FRESistance"	Impedance measurement (series equivalent circuit) and DC resistance measurement												
"FADMittance","FRESistance"	Admittance measurement (parallel equivalent circuit) and DC resistance measurement												
Setting example:	:FUNC 'FIMP','FRES' Specifies two measurement functions of impedance measurement and DC resistance measurement.												
Response:	<measurement function> {'FIMP' 'FADM' 'FIMP','FRES' 'FADM','FRES'}												
Query example:	:FUNC?												
Response example:	"FIMP","FRES" Two measurement functions of impedance measurement and DC resistance measurement are specified.												
Remarks:	The FIMPedance / FADMittance setting from the remote control and the series equivalent circuit / parallel equivalent circuit setting from the panel are interlocked (same).												

**:SOURce:CURRent:ALC[:STATe] {ON|OFF|1|0}**

**:SOURce:CURRent:ALC[:STATe]?**

Description: Sets/queries whether constant current drive is executed or not.

Parameters: {ON|1} Enables the constant current function. (Control so that monitored value falls within  $\pm 1\%$  of set value)  
 {OFF|0} Disables the constant current function.

Setting example: :SOUR:CURR:ALC OFF  
 Sets so as to disable the constant current function.

Response: {1|0}

Query example: :SOUR:CURR:ALC?

Response example: 0

Remarks: The constant current function is disabled.  
 The impedance range capable of driving with constant current is restricted by the measurement range.  
 For details  **“3.5.6.3 Measurement Range”**  
 The constant voltage function is automatically disabled if the constant current function is enabled.  
 When the constant current function is disabled, the device operates following the setting of measurement voltage, not the setting of measurement current.

**:SOURce:CURRent[:LEVel][:IMMediate][:AMPLitude] <current>**

**:SOURce:CURRent[:LEVel][:IMMediate][:AMPLitude]?**

Description: Sets/queries the measurement current level when constant current drive is executed.

Parameters: <current> {numeric value, range 1E-6 to 200E-3, resolution 3 digits (0.1E-6 for numeric value < 10E-6), unit: Arms} Suffix U ( $10^{-6}$ ) and M ( $10^{-3}$ ), and unit A can be used.  
 Example: 100U (= 1E-4), 10MA (= 0.01)

Setting example: :SOUR:CURR 2E-3  
 Sets the measurement current level to 2mArms.

Response: <current> {numeric value, format NR3}

Query example: :SOUR:CURR?

Response example: +2.00000E-03  
 The measurement current level is 2.00000E-03 Arms (2mArms).

**:SOURce:FREQuency[:CW] <frequency>****:SOURce:FREQuency[:CW]?**

Description: Sets/queries the measurement frequency.

Parameters: <frequency>  
 {numeric value, range 0.001 to 100.00E3, resolution 5 digits (<1mHz when 10Hz), unit : Hz} Suffix M ( $10^{-3}$ ) / K ( $10^3$ ), and unit: Hz , MAX/MIN can be used.  
 Example: 0.12K (= 120), 1KHZ (= 1E3)

Setting example: :SOUR:FREQ 1000  
 Sets the measurement frequency to 1kHz

Response: <frequency> {numeric value, format NR3}

Query example: :SOUR:FREQ?

Response example: +1.00000E+03  
 The measurement frequency is 100.00E+03 Hz (1kHz).

**:SOURce:RESistance[:LIMit]:LOW <resistance>****:SOURce:RESistance[:LIMit]:LOW?**

Description: Sets/queries the minimum output impedance of drive signal source.

Parameters: <resistance> { numeric value, range 5 or 25, unit:  $\Omega$  }  
 As a unit, OHM can be used. Parameter example: 5OHM (= 5).  
 If an arbitrary value is given, it becomes 5 or 25 whichever nearer.

Setting example: :SOUR:REG:LOW 25  
 Sets the minimum output impedance to 25 $\Omega$ .

Response: <resistance> {numeric value, format NR3}

Query example: :SOUR:REG:LOW?

Response example: +2.50000E+01  
 The minimum output impedance is 25 $\Omega$ .

**:SOURce:VOLTage:ALC[:STATe] {ON|OFF|1|0}****:SOURce:VOLTage:ALC[:STATe]?**

Description:	Sets/queries whether constant voltage drive is executed or not.
Parameters:	{ON 1} Enables the constant voltage function. (Control so that monitored value falls within $\pm 1\%$ of set value)
	{OFF 0} Disables the constant voltage function.
Setting example:	:SOUR:VOLT:ALC OFF Sets so as to disable the constant voltage function.
Response:	{1 0}
Query example:	:SOUR:VOLT:ALC?
Response example:	0 The constant voltage function is disabled.
Remarks:	The range in which ALC (automatic level control) functions actually is limited. For details  <b>“3.5.6.3 Measurement Range”</b> The constant current function is automatically disabled if the constant voltage function is enabled.

**:SOURce:VOLTage[:LEVel][:IMMEDIATE][:AMPLitude] <voltage>****:SOURce:VOLTage[:LEVel][:IMMEDIATE][:AMPLitude]?**

Description:	Sets/queries the measurement voltage level.
Parameters:	<voltage> {numeric value, range 0.010 to 5.00, setting resolution 3 digits (0.001 when <1), unit : Vrms} Suffix M ( $10^{-3}$ ), and unit V , MAX/MIN can be used. Example : 1000M (= 1), 500MV (= 0.5)
Setting example:	:SOUR:VOLT 0.5 Sets the measurement voltage level to 0.5 Vrms.
Response:	<voltage> {numeric value, format NR3}
Query example:	:SOUR:VOLT?
Response example:	+5.00000E-01 The measurement voltage level is 5.0000E-01 Vrms. (0.5 Vrms.).

**:SOURce:VOLTage[:LEVel][:IMMEDIATE]:OFFSet <DC offset>****:SOURce:VOLTage[:LEVel][:IMMEDIATE]:OFFSet?**

Description: Sets/queries internal DC offset(/bias) voltage superimposed on the measurement signal.  
To actually superimpose the DC offset, set additionally the following command so as to superimpose.

Parameters: `<DC offset>` {numeric value, range 0 to 2.50, resolution 0.01, unit: V}  
Unit V and MAX / MIN can be used. Example: 0.5V (= 0.5)

Setting example: `:SOUR:VOLT:OFFS 1.5`  
Sets the DC offset voltage to 1.5.

Response: `<DC offset>` {numeric value, format NR3}

Query example: `:SOUR:VOLT : OFFS?`

Response example: `+1.50000E+00`  
The DC offset voltage is +1.50000E+00V(1.5V).

**:SOURce:VOLTage[:LEVel][:IMMEDIATE]:OFFSet:STATe {ON|OFF|1|0}****:SOURce:VOLTage[:LEVel][:IMMEDIATE]:OFFSet:STATe?**

Description: Sets whether internal DC offset(/bias) voltage is superimposed on the measurement signal.

Parameters: `{ON|1}` DC offset voltage is superimposed.  
`{OFF|0}` DC offset voltage is not superimposed.  
The DC offset cannot be turned on when the triggered drive is enabled.

Setting example: `:SOUR:VOLT:OFFS:STAT 1`  
Sets so as to superimpose the DC offset voltage.

Response: `{1|0}`

Query example: `:SOUR:VOLT : OFFS:STAT?`

Response example: `1`  
DC offset voltage is superimposed.

**:SOURce:VOLTage:MODE {CONTinuous|SYNChronous}****:SOURce:VOLTage:MODE?**

Description: Sets/queries the triggered drive.

Parameters: `CONTinuous` Triggered drive is disabled and measurement signal is output continuously.  
`SYNChronous` Triggered drive is enabled and measurement signal is output only during measurement. DC offset is turned off.

Setting example: `:SOUR:VOLT:MODE SYNC`  
Sets so as to output the measurement signal only during measurement in synchronization with the trigger.

Response: `{CONT|SYNC}`

Query example: `:SOUR:VOLT:MODE?`

Response example: `SYNC`  
The measurement signal is output only during measurement.



**:STATus:OPERation:CONDition?**

Description: Queries the operation condition register (OPCR).

Response: {numeric value, format NR1, range 0 - 32767}

Query example: :STAT:OPER:COND?

Response example: +0

The content of operation condition register is 0.

**:STATus:OPERation:ENABLE <mask>****:STATus:OPERation:ENABLE?**

Description: Sets/queries the operation event enable register (OPEE).

Parameters: <mask> {numeric value, range 0 - 65535}

Out of range value causes an error.

Setting example: :STAT:OPER:ENAB 0

Sets so as to disable the occurrence of operation event.

Response: {numeric value, format NR1, range 0 - 32767}

Query example: :STAT:OPER:ENAB?

Response example: +0

The content of operation event enable register is 0. (all disabled)

**:STATus:OPERation[:EVENT]?**

Description: Queries the operation event register (OPER).

Response: {numeric value, format NR1, range 0 - 32767}

Query example: :STAT:OPER?

Response example: +0

The content of operation event register is 0 (no event).

For details of operation status, see “5.7.4 Operation Status”.

**:SYSTem:ERRor?**

Description: Queries the error content.

Response: <error number>, <error message>  
           <error number>        {numeric value, format NR1, range -32768 to +32767}  
           <error message>      Format SRD  
           For details  **"7.1.3 Remote control error"**.

Query example: :SYST:ERR?

Response example: +0,"No error"  
                   No error is found.

Remarks:        The oldest error recorded in the error queue is read.  
                   The content of read error is cleared from the error queue.  
                   Maximum 16 errors can be saved in the error queue. If exceeding this capacity, 16th error message changes to "Queue overflow", and error messages after that are dumped.

**:SYSTem:KLOCK {ON|OFF|1|0}****:SYSTem:KLOCK?**

Description: Sets/queries the key lock function of the front panel.

Parameters: {ON|1}    Turns on the key lock function (key operations are disabled).  
               {OFF|0}   Turns off the key lock function (key operations are enabled).

Setting example: :SYST:KLOC 1  
                   Sets so as to turn on the key lock (key operations are disabled).

Response:        {1|0}

Query example: :SYST:KLOC?

Response example: 1  
                   The key lock is turned on (key operations are disabled).

**:SYSTem:MEMory {SETTing|CORRection|BOTH}****:SYSTem:MEMory?**

Description:	Sets/queries the target to be recalled from the memory through selection line of handler interface.	
Parameters:	SETTing	Settings (measurement conditions such as frequency)
	CORRection	Correction values (OPEN, SHORT, LOAD)
	BOTH	Both settings and correction values
Setting example:	:SYST:MEM CORR Sets correction values as the target to be recalled.	
Response:	{SETT CORR BOTH}	
Query example:	:SYST:MEM?	
Response example:	CORR	
Remarks:	The target to be recalled is correction values. This command is not supported by <b>ZM2371</b> . An error will occur.	

**:SYSTem:RCL <memory number>,{SETTing|CORRection|BOTH}**

Description:	Recalls the settings or correction values from the specified memory.	
Parameters:	<memory number>	{numeric value, range 0 - 31} Out of range value causes an error.
	SETTing	Recalls the settings (measurement conditions such as frequency).
	CORRection	Recalls the correction values (OPEN, SHORT, LOAD).
	BOTH	Recalls both settings and correction values.
Setting example:	:SYST:RCL 2,BOTH Recalls both settings and correction values from the memory number 2. When only the correction values are recalled, the correction is not turned on automatically.	

**:SYSTem:SAVE <memory number>,{SETTing|CORRection|BOTH}**

Description:	Saves the settings and correction values in the specified setting /correction value memory.	
Parameters:	<memory number>	{numeric value, range 0 - 31} Out of range value causes an error.
	SETTing	Saves the settings (measurement conditions such as frequency).
	CORRection	Saves the correction values (OPEN, SHORT, LOAD).
	BOTH	Saves both settings and correction values.
Setting example:	:SYST:SAVE 2,CORR Saves the correction values in the memory number 2.	

**:TRIGger:DELay <delay time>****:TRIGger:DELay?**

Description: Sets/queries the trigger delay time.  
Trigger delay time: Time from the trigger to the start of measurement.

Parameters: {numeric value, range 0 - 999.999, resolution 0.001, unit: s}  
Suffix M ( $10^{-3}$ ), unit S, MAX / MIN can be used.  
Example: 10M (= 0.010), 200MS (= 0.200)

Setting example: :TRIG:DEL 0.02  
Sets the trigger delay time to 20ms.

Response: {numeric value, format NR3}

Query example: :TRIG:DEL?

Response example: +2.00000E-02  
The trigger delay time is 2.00000E-02 s (20ms).

**:TRIGger[:IMMediate]**

Description: Applies the trigger to perform measurement once, when the device waits for trigger.  
An error will occur when the trigger source is INT or the device does not wait for trigger.

Setting example: :TRIG  
Applies the trigger.

**:TRIGger:SOURce {INTernal|MANual|EXTernal|BUS}****:TRIGger:SOURce?**

Description: Sets/queries the trigger source.

Parameters: INTernal Internal trigger (trigger is continuously applied automatically)  
MANual TRIG key on the front panel  
EXTernal TRIG signal through handler interface  
BUS \*TRG command, GET message of remote control

Setting example: :TRIG:SOUR EXT  
Sets EXT as a trigger source.

Response: {INT | MAN | EXT | BUS}

Query example: :TRIG:SOUR?

Response example: EXT  
The trigger source is EXT.

## 5.7 Status System

### 5.7.1 Status System Overview

The status system for ZM2371/ZM2372 is shown on Figure 5-2.

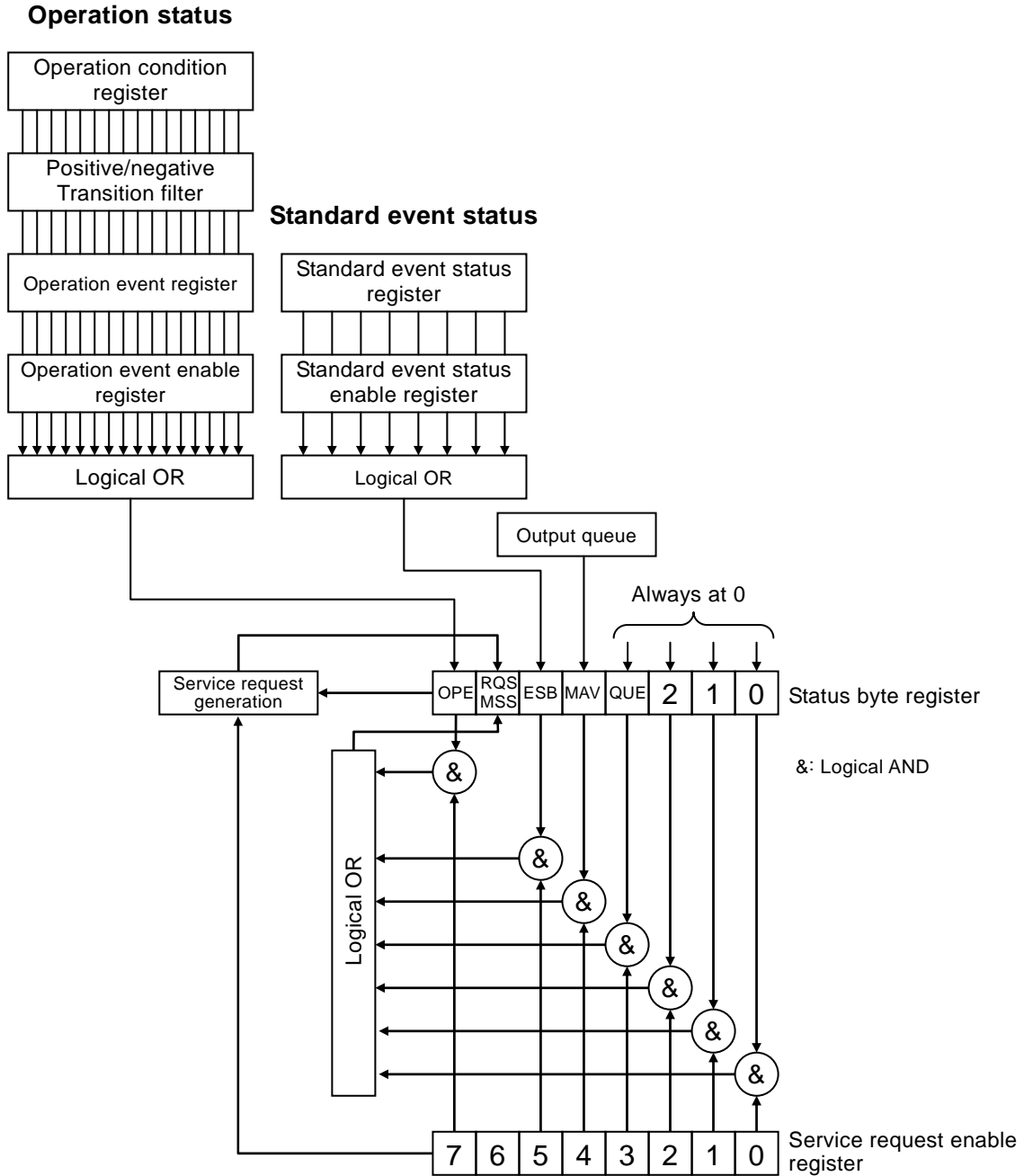

Figure 5-2 Status system

### 5.7.2 Status Byte

The definition of status byte register is shown in **Table 5-4**. For the status byte register, the bits that set “1” to the service request enable register become valid, and if even any one of valid bits is set to “1”, the service request occurs.

The status byte can be read by serial polling or \*STB? query. However, bit 6 becomes RQS (Request Service) when serial polling is used for reading, or MSS (Master Summary Status) when \*STB? query is used.

**Table 5-4 Status byte register definitions**

Bit	Weight	Condition for setting to “1”	Condition for resetting to “0”	
OPE	7	128	When any valid bit of the operation status event register is set to 1.	<ul style="list-style-type: none"> <li>When device clear was received</li> <li>After status byte was read</li> </ul>
RQS / MSS	6	64	When SQR is sent	<ul style="list-style-type: none"> <li>When device clear was received</li> <li>Bit 6 becomes RQS when status byte was read by serial polling</li> <li>Bit 6 becomes MSS when master summary bits were all cleared to “0”</li> </ul>
ESB	5	32	When any valid bit of the standard event status register is set to 1.	When all the valid bits of the standard event status register are set to 0.
MAV	4	16	When the response to the query is ready to be output.	When all of the responses have been output and there remains not to be output.
QUE	3	8	—	Always at 0 (unused)
—	2	4	—	Always at 0 (unused)
—	1	2	—	Always at 0 (unused)
—	0	1	—	Always at 0 (unused)

When two or more bits are “1”, if the content of status byte is queried, the value added with the weight of all bits that were set to “1” becomes a response message.

#### ■ About verifying status when querying

Normally, once a query command is transmitted, you can receive the response correctly, if response message is received. There is no need to check the MAV bit of the status byte.

When a processing is progressed while checking the MAV bit, after the query was transmitted, check by serial polling that the MAV bit of status byte becomes “1”, and then read the response message, and after checking that the MAV bit becomes “0”, perform the next operation.

### 5.7.3 Standard Event Status

The standard event status structure is shown on **Figure 5-3**. Details about status are shown in **Table 5-5**. When the standard event status enable register bits are set to 1, the corresponding standard event status register bits become valid. When at least one such bit is set to 1, the status bit register ESB bit is set to 1.

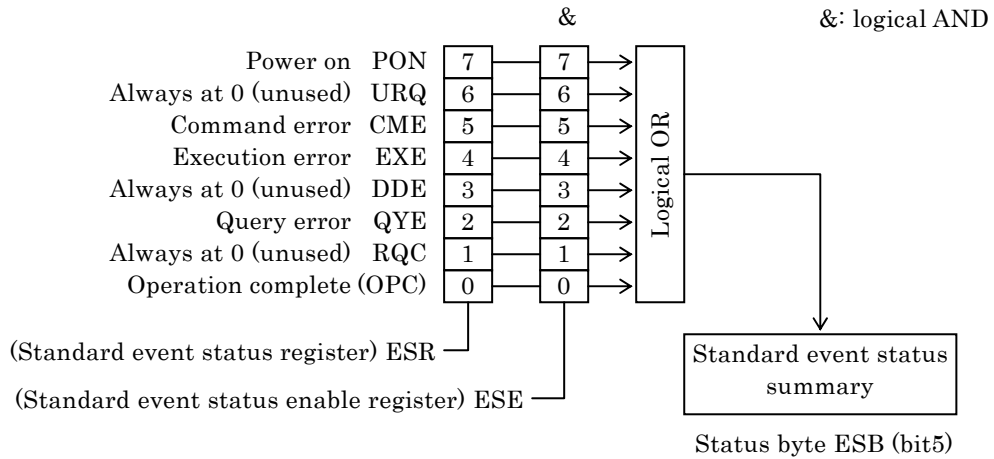

**Figure 5-3 Standard event status structure**

**Table 5-5 Standard event status register contents**

Bit	Weight	Contents
PON	7	128 Power on Set to 1 when the power is on. If set to 0 by a register readout, remains at 0 until the power is turned on again.
URQ	6	64 User request Always at 0 (unused)
CME	5	32 Command error Set to 1 when there is a syntax error in program code.
EXE	4	16 Execution error Set to 1 when parameters are set beyond possible range values or when settings are contradictory.
DDE	3	8 Device dependent error Set to "1" when the error queue overflows.
QYE	2	4 Query error Set to 1 when a readout has been attempted on an empty response message output buffer or when the response message output buffer data has been lost.
RQC	1	2 Request control Always at 0 (unused)
OPC	0	1 Operation complete Set to "1" when a processing of all commands up to *OPC command completed.

■ **Related commands/ queries**

**\*ESR?**

Queries the contents of the standard event status register.

Cleared to 0 upon query. Can be cleared also by \*CLS command.

Cleared to 0 upon powering on. However the PON bit is set to 1.

**\*ESE / \*ESE?**

Sets/queries the standard event status enable register.

Set to 0 to clear the enable register to 0.

Cannot be cleared by any other command.

Cleared to 0 upon powering on.

The parameter value of the setting message or response message to each register is the sum of the weight of all the bits having 1 as the value.



### 5.7.4 Operation Status

The operation status structure is shown on **Figure 5-4**.

As can be seen on **Table 5-6**, the operation condition register indicates **ZM2371/ZM2372** status.

The transition filter detects a condition change and causes an event to occur. The filter setting of **ZM2371 / ZM2372** is fixed. The operation event register retains the events that occurred. When the operation event enable register bits are set to 1, the corresponding operation event register bits become valid. When at least one such bit is set to 1, the status byte OPE bit is set to 1.

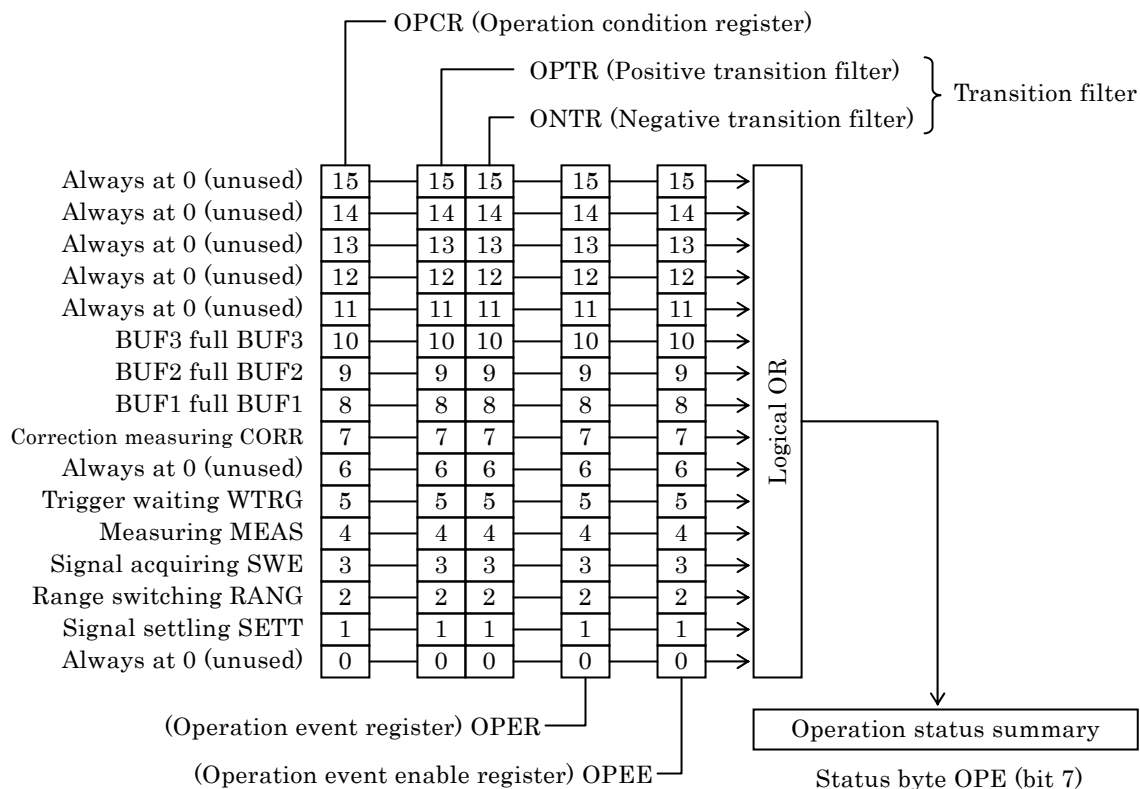

**Figure 5-4** Operation status structure

**Table 5-6 Contents of operation condition register and event register**

Bit		Weight	Content of condition register ("1" when specified status is fulfilled)	Content of event register (Condition for setting to "1")
—	15	32768	Always at 0 (unused)	Always at 0
—	14	16384		
—	13	8192		
—	12	4096	Always at 0 (unused)	Always at 0
—	11	2048	Always at 0 (unused)	Always at 0
BUF3	10	1024	BUF3 is full	BUF3 becomes full
BUF2	9	512	BUF2 is full	BUF2 becomes full
BUF1	8	256	BUF1 is full	BUF1 becomes full
CORR	7	128	Either OPEN, SHORT, or LOAD correction is being measured	Correction measurement completed
WARM	6	64	Always at 0 (unused)	Always at 0
WTRG	5	32	Trigger waiting	Device waits for trigger
MEAS	4	16	Measuring (/EOM signal of handler interface is on high level)	Measurement completed
SWE	3	8	Signal acquiring (/INDEX signal of handler interfaced is on high level)	Signal acquisition completed
RANG	2	4	Range switching by automatic range selection function	Measurement range has been established
SETT	1	2	Signal settling (trigger is being delayed)	Signal has settled (trigger delay finished)
—	0	1	Always at 0 (unused)	Always at 0

**■ Related commands/ queries**

`:STATus:OPERation:CONDition?`

Queries the operation condition register contents.

The condition register contents is not cleared to 0 even if queried.

The device status is always indicated.

`:STATus:OPERation[:EVENT]?`

Queries operation event register.

The event register is cleared to 0 if queried.

The event register can also be cleared with a `*CLS` command.

Cleared to 0 upon powering on.

`:STATus:OPERation:ENABLE / STATus:OPERation:ENABLE?`

Sets/queries the operation event enable register.

Set to 0 to clear the enable register to 0.

Cannot be cleared by any other command.

Cleared to 0 upon powering on.

A parameter of each register setting message or response message takes a value that adds up the weight of all bits set to 1.

## 5.8 Trigger System

The trigger system of **ZM2371 / ZM2372** is shown below.

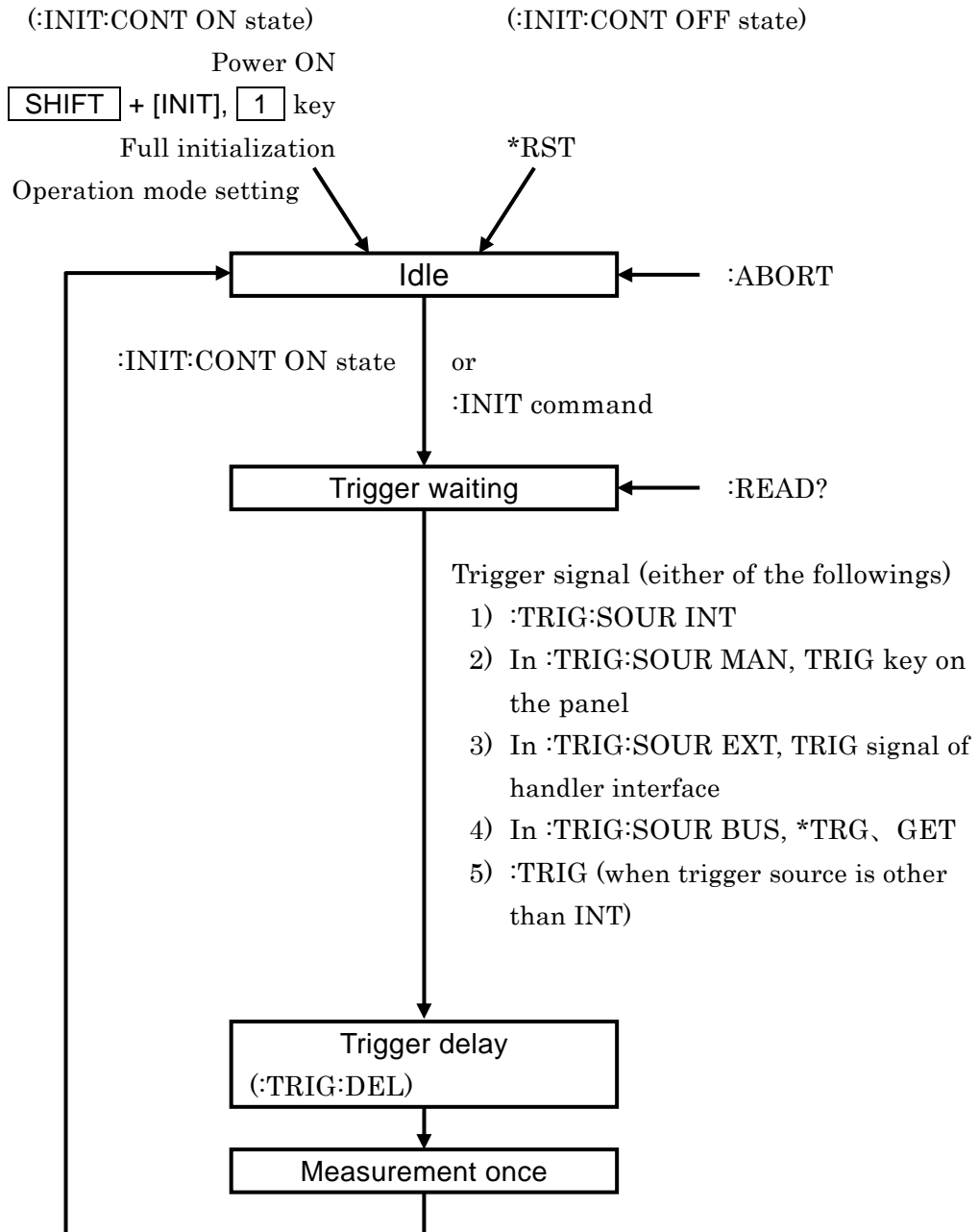

Figure 5-5 Trigger system

Here shown are typical examples in which a trigger is applied to the **ZM2371 / ZM2372** to execute measurement once to obtain the measured result, and this operation is repeated.

### Example 1 Measured value is obtained by \*TRG command

Power ON	' Setting equivalent to :INIT:CONT ON
Transmit (":INIT:CONT ON")	' Specify definitely when it's not known exactly how after start (Note 1)
Transmit (":TRIG:SOUR BUS")	' Set so as to apply trigger by remote control
Transmit (":ABORT")	' → Idle → Trigger waiting state
→	
Transmit ("*TRG")	' Apply trigger, and transfer measured result
Receive (measurement status, primary parameter measured value, secondary parameter measured value)	

Note 1: If :INIT:CONT OFF, after the first measurement, the device remains in idle state, and thus the trigger at the second and subsequent times becomes ineffective.

### Example 2 Measured value is obtained by :TRIG command and :FETCH? query

Transmit ("*RST")	' Setting equivalent to :INIT:CONT OFF
Transmit (":TRIG:SOUR EXT")	' Set trigger source to handler interface
→	
Transmit (":INIT")	' Device goes in trigger waiting state
Transmit (":TRIG")	' Trigger can also be applied from handler interface, omitting this command
Transmit (":FETC?")	' Query the latest measured value
Receive (measurement status, primary parameter measured value, secondary parameter measured value)	

For the limit comparison, :CALC1:LIM:FAIL? can also be used instead of :FETC?

### Example 3 Measured value is obtained by READ? query

Transmit ("*RST")	' Setting equivalent to :INIT:CONT OFF
Transmit (":TRIG:SOUR EXT")	' Set trigger source to handler interface
Transmit (":INIT:CONT ON")	' Set so as to return to trigger waiting after measurement completed
→	
Transmit (":READ?")	' → Idle → In trigger waiting state, wait for trigger (Note 2)
	' When trigger is applied and one-time measurement finished,
	' the result is transmitted
Receive (measurement status, primary parameter measured value, secondary parameter measured value)	

Note 2: If :READ? query is executed, the device does not execute the next command until the measured result is stored completely in the transmission buffer. The :TRIG command of a program message ":READ?::TRIG" is executed after READ? query started and the measurement started by TRIG signal of handler interface finished.

## 5.9 Sample Programs

Sample programs that control the **ZM2371 / ZM2372** by combining typical program languages and respective interfaces of GPIB, USB, and RS-232 have been stored in the attached CD-ROM. For details, see the documentation of attached CD-ROM.

## **6. CHANGE OF OPERATION MODE**

6.1 Outline and Switching of Operation Mode .....	6-2
---	-----

## 6.1 Outline and Switching of Operation Mode

The **ZM2372** has basic structure that can change the remote control commands by switching the operation mode. At present, however, only one standard operation mode is supported.

The **ZM2371** can use the standard operation mode only.

### 1) Operation mode 0

This mode is the standard operation mode of **ZM2371 / ZM2372**. The factory default setting is the operation mode 0.

The operating method and functions in the operation mode 0 are described in **Chapters 3, 4, and 5**.

### 2) Operation mode 1

This mode can be set only when the **ZM2372** is extended so that it has two operation modes.

The operation mode 1 is different in remote control commands from the operation mode 0.

### ■ Switching of operation mode

The operation mode is switched with the system settings menu.

**SHIFT** + [ **SYSTEM** ]

[ **SHIFT** ] + [ **SYSTEM** ] keys to display the system settings menu.

<b>SYSTEM settings</b>		
<b>0)INTERFACE</b>	<b>1)BEEPER</b>	<b>&gt;NEXT</b>

Options (first page)

Though no options are displayed in the system menu, if [ **-** ] [ **2** ] [ **3** ] [ **0** ] [ **0** ] keys are pressed in this order, the operation mode setting menu is displayed as shown below.

<b>Operation mode:0</b>	Current setting
<b>0)Mode 0</b>	Option

<b>0)Mode 0</b>	<b>1)Mode 1</b>	Options (when <b>ZM2372</b> is extended)
-----------------	-----------------	--

If a mode is set or **EXIT** key is pressed, the measurement screen comes back.

When the operation mode is set, the initialization equivalent to "INITIALIZE ALL" in each operation mode is executed. At present, for both **ZM2371** and **ZM2372**, only the operation mode 0 can be selected. If the operation mode 0 is selected, all settings are reset to the factory default settings.

The operation mode cannot be initialized by any method other than the selection of operation mode 0.

In the operation mode 1, the underline cursor is displayed at the end of second line of the display.

Operation mode 0	<table border="1"> <tr> <td>• • • • • • •</td> <td><b>1.0000k</b></td> </tr> <tr> <td>• • • • • • •</td> <td><b>1.00 Vc</b></td> </tr> </table>	• • • • • • •	<b>1.0000k</b>	• • • • • • •	<b>1.00 Vc</b>
• • • • • • •	<b>1.0000k</b>				
• • • • • • •	<b>1.00 Vc</b>				
Operation mode 1	<table border="1"> <tr> <td>• • • • • • •</td> <td><b>1.0000k</b></td> </tr> <tr> <td>• • • • • • •</td> <td><b>1.00 Vc</b></td> </tr> </table>	• • • • • • •	<b>1.0000k</b>	• • • • • • •	<b>1.00 Vc</b>
• • • • • • •	<b>1.0000k</b>				
• • • • • • •	<b>1.00 Vc</b>				

← Underline



# 7. TROUBLESHOOTING

7.1	Error Messages.....	7-2
7.1.1	Errors at Power ON.....	7-2
7.1.2	Errors at Panel Operation.....	7-3
7.1.3	Errors During Measurement .....	7-4
7.1.4	Errors in Remote Control.....	7-5
7.1.5	Measured Value Display in Case of Error.....	7-7
7.2	When the Device Appears to be a Problem.....	7-8

## 7.1 Error Messages

An error in the self-diagnosis at the power on or a failure in the panel operation or remote control causes an error message to be displayed.

This chapter describes the content, cause, and corrective action of main error messages.

When the repair is required, please contact NF Corporation or one of our representatives.

When you request the repair of **ZM2371 / ZM2372**, please let us know the content of an error message if it is displayed. An error message not listed in this instruction manual may be displayed due to a malfunction caused by strong external noise.

Before an error message, internal status at the time when an error occurred may be displayed. When making an inquiry to NF Corporation, giving us the internal status along with the error message will be helpful to solve the problem.

Warning Level:n	Code xxxxxxxx	Error Message
Internal status		Usual message

A special message not listed here may be displayed, for instance, when the firmware is updated. If other documents are supplied, refer to such documents.

### 7.1.1 Errors at Power ON

At the power on, the self-diagnosis is conducted and if an error is found, an error message as listed below is displayed on the initial screen.

Error message	Content and Cause	Corrective action
ROM ERROR	Internal memory (ROM) error	Turn off the power once, and turn it on again. If the error occurs again, the device is defective, requiring the repair. If either of these errors is detected, the error message is kept displayed, and the device cannot proceed to usual operation.
RAM ERROR	Internal memory (RAM) error	
Calibration memory lost	Calibration data has been lost	
Hardware failed	Measuring circuit failure	
Oscillator failed	Drive signal source (H <sub>CUR</sub> terminal) failure	
Analyzer failed	Voltage & current measuring section failure	
Previous setting lost	Settings or correction values have been lost. An error is found in the setting memory, correction value memory, or resume memory. <ul style="list-style-type: none"> <li>• Defective memory</li> <li>• Temporary failure due to power off, etc. during data processing</li> </ul>	Re-set the lost data. If data loss is detected, the memory is initialized and the device proceeds to usual operation. This error message can be reset by pressing any key.
Configuration memory lost	System settings such as GPIB address have been lost. <ul style="list-style-type: none"> <li>• Defective memory</li> <li>• Temporary failure due to power off, etc. during data processing</li> </ul>	If this error message is displayed every time when the power is turned on, the device is defective, requiring the repair.

### 7.1.2 Errors at Panel Operation

Main errors due to the panel operation are as listed below.

<b>Error message</b>	<b>Content and Cause</b>	<b>Corrective action</b>
Settings conflict	Specified settings could not be made due to the restriction by other settings.	Use within restricted conditions. Or, change the settings that restrict others.
BIAS Over	DC bias voltage setting was limited so that it does not exceed the maximum output voltage (about 7V <sub>peak</sub> ) because measurement signal level is large.	Reduce the signal level when large DC bias voltage is required.
LEVEL Over	Measurement signal level setting was limited so that it does not exceed the maximum output voltage (about 7V <sub>peak</sub> ) because DC bias voltage is output.	Reduce the DC bias voltage setting or turn off the DC bias output when large measurement signal is required.
Memory error	Contents of settings or correction value memory are destroyed.	Re-save the contents.

Since there are other error messages and warning messages not listed here, see the description of respective operations.

### 7.1.3 Errors During Measurement

Main error messages displayed during measurement or during measurement of correction values are as listed below.

Error message	Content and Cause	Corrective action
Trigger ignored	<ul style="list-style-type: none"> <li>When trigger source is INT (internal), an attempt to apply other trigger was made and thus that trigger was ignored.</li> </ul>	Set the trigger source correctly according to actual trigger signal.
	<ul style="list-style-type: none"> <li>Though the device does not wait for trigger, an attempt to apply the trigger was made and thus that trigger was ignored. Possible causes will be as follows:</li> </ul> <ol style="list-style-type: none"> <li>During the measurement, the trigger is not accepted.</li> <li>If *RST command is executed, continuous initiation is disabled, and thus the trigger immediately after that is not accepted.</li> </ol>	<p>For the operation from the panel, initialize by pressing <b>[SHIFT]</b> + <b>[INIT]</b>, <b>[1]</b> keys.</p> <p>For the operation from remote control,</p> <ol style="list-style-type: none"> <li>Send :ABORT command to abort the measurement once.</li> <li>Send :INIT:CONT ON command or :INIT command to place the device in trigger waiting status.</li> </ol>
	<ul style="list-style-type: none"> <li>The device is in over-temperature statue, and thus the trigger was ignored.</li> </ul>	Allow time until internal temperature lowers sufficiently, and reset the error.
Correction meas failed	OPEN, SHORT, LOAD correction values could not be measured.	Perform usual measurement to check the condition where measurement failed, and then remove a problem.
Timeout error	<ul style="list-style-type: none"> <li>As the measurement impossible state lasts for a long time, the measurement was terminated forcibly.</li> </ul> <p>Main cause is large external noise or electrostatic discharge.</p>	<p>Install device or cables that generate large noise away from the LCR meter.</p> <p>Beware of charged device or human body so as not to discharge to the LCR meter during measurement.</p>
Over Temperature (Tripped)	<ul style="list-style-type: none"> <li>Over-temperature was detected. The drive signal level becomes zero, disabling new measurement.</li> </ul> <p>Main causes will be as follows:</p> <ol style="list-style-type: none"> <li>The impedance below 1Ω was measured for a long time at a place of high ambient temperature.</li> <li>Cooling fan is defective.</li> </ol>	<p>Remove a cause of over-temperature, and then allow time until internal temperature lowers sufficiently, and reset the error.</p> <ol style="list-style-type: none"> <li>Restrain the internal temperature by lowering the ambient temperature or executing intermittent measurement by triggered drive.</li> <li>Please ask NF Corporation or one of our representatives for repair.</li> </ol>
Over Temperature (Removed)	<ul style="list-style-type: none"> <li>Though over-temperature was detected, the temperature has already lowered at which the device can operate.</li> </ul>	Press <b>[ENTR]</b>   <b>[EXIT]</b> key to reset this message, and the device will be recovered to usual operation.

Other error message may be displayed according to the situations.

For warning messages displayed due to various operations, see the description of each operation.

### 7.1.4 Errors in Remote Control

This section describes main errors that occur in the remote control.

Error No.	Error message	Cause
0	No error	---
-100	Command error	Command is not correct. (No detailed classification)
-102	Syntax error	Unrecognizable command or data was received.
-104	Data type error	The format of parameter is improper.
-108	Parameter not allowed	Too many parameters are used, or a parameter is used in illegal position.
-109	Missing parameter	The number of parameters is deficient.
-110	Command header error	Command header is not correct. (No detailed classification)
-113	Undefined header	Undefined command header is used.
-120	Numeric data error	Numeric data is not correct. (No detailed classification)
-130	Suffix error	Suffix (multiplier, unit) is not correct. (No detailed classification)
-140	Character data error	Character data is not correct. (No detailed classification)
-144	Character data too long	Character data is too long (> 12 characters).
-150	String data error	Character string data is not correct. (No detailed classification)
-200	Execution error	Command cannot be executed. (No detailed classification)
-211	Trigger ignored	Trigger was received but could not be executed.
-221	Settings conflict	Command could not be executed due to the restriction between plural settings.
-222	Data out of range	Data is out of allowable range.
-241	Hardware missing	Command cannot be executed because hardware to be operated is not installed.
-300	Device-specific error	Command cannot be executed because of device-specific internal error. (No detailed classification)
-310	System error	Device-specific internal error occurred. (For instance, loss of memory data)
-330	Self-test failed	An error was found in the self-test.
-350	Queue overflow	The error queue overflows, and it cannot retain new error.
-363	Input buffer overrun	The input buffer overflows.
-410	Query INTERRUPTED	Response to query was interrupted by the subsequent command.
-420	Query UNTERMINATED	Response was requested before reception of query is completed.
-430	Query DEADLOCKED	Processing cannot be continued because of full buffer.
-440	Query UNTERMINATED after indefinite response	Response is not correct because there is another query after the query that requests arbitrary length response.

Errors in remote control are recorded in the error queue, and they can be read, one by one starting from oldest error, with the query :SYSTem:ERRor?. After all errors were read, if the error queue is further read, +0, "No error" will be returned. The error queue can be cleared with \*CLS command.

The data remaining in the input buffer or output buffer due to occurrence of a problem can be cleared with the device clear (DCL, SDC), which is one of the interface messages.

Though errors not listed here may occur according to the situations, the outline of them can be confirmed from the error messages.

For the items that can be operated from the panel, same messages as those for panel operation are displayed. Accordingly, check the description of panel operations related to each command and query. The errors that occur in usual measurement are also displayed under the remote control.

### 7.1.5 Measured Value Display in Case of Error

If an error occurred in the impedance measurement, the primary parameter, secondary parameter, voltage monitored value, or current monitored value which is a measured value is displayed as follows.

Display of measured value	Content and Cause	Corrective action
NC (No Contact)	Contact failure: A contact failure was detected in the contact check.	Check the connection cables and contact conditions to ensure stable connections.  The measured value read by the remote control is the error value 9.9E+37.
ERR (ERRor)	Measurement error: Correct measured value cannot be obtained due to any error such as detection of voltage or current out of measurable range.  Main causes will be as follows: 1) Improper measurement range 2) Noise mixed in	1) Switch to proper measurement range. 2) Use electrostatic shield to prevent peripheral noise from mixing in.  The measured value read by the remote control is the error value 9.9E+37.
ALC Err (ALC Error)	ALC error: Though ALC is enabled, the voltage or current monitored value cannot be adjusted within the specified range.  Main causes will be as follows: 1) Out of adjustable range 2) Since the DUT has strong nonlinear voltage-current characteristics, the built-in algorithm failed to adjust. 3) Since the DUT parameter value varies, repetitive adjustment failed to obtain the specified value.	1) No corrective action available. Use the device on the measurement signal level in a range of 10mV <sub>rm</sub> to 5V <sub>rms</sub> . 2) Adjust manually the measurement signal level so that the monitored value becomes the specified value. 3) Adopt the measured value successfully obtained by the measurement.  The measured value read by the remote control is the error value 9.9E+37.  The voltage and current measured values are displayed even if out of specified range.
CORR Err (CORRection Error)	Correction error: Since the OPEN correction value and SHORT correction value are too close or reversed, any of OPEN, SHORT, and LOAD corrections cannot be executed.	Measure or set the correction value in a range where the impedance of OPEN correction value is larger than two times the impedance of SHORT correction value.  The measured value read by the remote control is the error value 9.9E+37.
OVF (OVerFlow)	Overflow: Measured value exceeds the display range.	Switch to proper measurement range. Measured value may be displayed by changing the type of parameters. In the remote control, the measured value is output within the specified range of remote control, regardless of the display.

## 7.2 When the Device Appears to be a Problem

When the device appears to be a problem, check the following table to see if a corrective action is given. When the problem persists or the device cannot be recovered though a corrective action was taken, please contact NF Corporation or one of our representatives.

**Table 7-1 When the device appears to be a problem 1/3**

Problem	Possible cause	Correction action
The power does not turn on	The power cord is not connected correctly. The power supply out of rated range is used.	Insert the power cord tightly.  Check the voltage of power outlet with a multimeter.
Panel operation dose not work	The key lock is turned on.	When KEY LOCK lamp is lighting, press <b>[SHIFT]</b> + <b>[KEY LOCK]</b> keys to cancel the key lock.
	/KEY_LOCK signal of handler interface is active (Low).	Make the /KEY_LOCK signal inactive (High). No other resetting method is available.
	The device is in remote state.	When REMOTE lamp is lighting, press <b>[LOCAL]</b> key to return to the local state. If the local lockout is set with USB or GPIB, the device cannot return to the local from the panel operation. Return the device to local from the controller, or disconnect the USB cable or GPIB cable.
	Keys are deteriorated.	Please ask NF Corporation or one of our representatives for repair.
Trigger is not applied	By *RST command :INIT:CONT OFF setting is retained. In this case, the trigger is not applied even if trigger source is INT (internal).	Try to perform the following operations: • Initiate the trigger system with :INIT:CONT ON or :INIT command. • Press <b>[SHIFT]</b> + <b>[INIT]</b> , <b>[1]</b> keys to execute initialization. • Turn off and on the power.
	Trigger source setting is incorrect.	Check the trigger source setting. For example, to apply the trigger by remote control (USB, RS-232, GPIB), set the trigger source to BUS. At this time, manual trigger is ineffective.
Device cannot be operated as described in the instruction manual	Settings are not initialized.	In general, the operations are described, provided that the settings have been initialized. Retry after initialization by pressing <b>[SHIFT]</b> + <b>[INIT]</b> , <b>[1]</b> keys.
	Operation mode is incorrect.	Set the operation mode correctly by referring to “ <b>6.1 Outline and Switching of Operation Mode</b> ”. The underline cursor is displayed at the lower right of display in other than standard operation mode.



Table 7-1 When the device appears to be a problem 2/3

Problem	Possible cause	Correction action
Large variations of measured value	Measurement speed is too fast.	Reduce the measurement speed within allowable range. If the averaging function is used together, more precise speed can be set.
	Signal level is too small.	Increase the signal level.
	Measurement started before the signal settles.	Make the trigger delay time longer. Start the measurement after the contact becomes stable and the signal settled.
	The current cables and voltage cables interfere with each other (measured value varies when the cables move).	Twist the current cable to current cable, and the voltage cable to voltage cable respectively to reduce the mutual interference.
	Noise mixes in.	<p>&lt;Electrostatic induction&gt; When high impedance is measured, electrostatic-shield the L-side signal wires appropriately. Exposed signal wires cause the device to be affected by peripheral potential variations. Also, ground the case and peripheral conductors.</p> <p>&lt;Electromagnetic induction&gt; Route the connection cables so that a large loop is not formed.</p> <p>&lt;Common impedance coupling&gt; Do not ground outer conductor of connection cables. If grounded, noise current or a signal of adjacent LCR meter will flow in, affecting the measurement.</p>
	Signals interfere between multiple LCR meters	With the triggered drive enabled, adjust the trigger timing so that the measurement signals of respective meters do not overlap temporally.
	Two-terminal connection is made	Make four-terminal connection. If low impedance is measured with two-terminal connection, contact resistance will have strong effect. Do not connect between H <sub>CUR</sub> and H <sub>POT</sub> or between L <sub>CUR</sub> and L <sub>POT</sub> in the middle of wiring.
	Contact to DUT is unstable	<p>Clean the contacts.</p> <p>Turn on the contact check to check for abnormality.</p> <p>The contact resistance can be checked with resistance value between H<sub>CUR</sub> and H<sub>POT</sub> or between L<sub>CUR</sub> and L<sub>POT</sub>. The influence of contact resistance can be checked by replacing a contact point with known series resistance.</p>
Measurement signal becomes small due to damage of measurement signal source or defective connection cables	<p>Check the magnitude of signal with a voltage monitor or current monitor.</p> <p>If discharge is made to measurement terminals, the measurement signal source, voltage detector, or current detector may be damaged.</p> <p>Check the cables for disconnection, or the inner and outer conductors for short-circuit.</p>	

Table 7-1 When the device appears to be a problem 3/3

Problem	Possible cause	Correction action
Measured value differs largely from expected value measurement is impossible or correction values cannot be measured	Wrong correction values are set	Try to turn off OPEN, SHORT, and LOAD correction values. Re-measure or re-set correction values.
	Measurement conditions are incorrect.	Set the frequency and signal level to the specified values. Measured value may vary largely with the measurement conditions depending on the DUT.
	The shield-to-shield connection of connection cables is not made.	For four connection cables, connect their outer conductor (shields) together. Otherwise, a return path of measurement current is not formed, causing a measurement failure.
	Connection cables to DUT or contacts are defective.	Check the cables for continuity, or the inner and outer conductors for short-circuit, or the contacts for contamination.
	The L side of DUT is grounded. Or, DUT is grounded with low impedance.	Do not connect the DUT's terminal to the ground. <b>ZM2371 / ZM2372</b> cannot measure the grounded DUT. This is also true for the measurement of correction values.
	Internal impedance bridge is unstable (too large capacitance between L terminal of DUT and ground).	Including the capacitance of four connection cables, restrain the capacitance between L terminal of DUT and ground to about 2000pF or less. For large DUT or DUT having complex construction, the capacitance to ground (capacitance to shield) may be very large.
	Noise mixes in. Exposed signal lines (particularly L side) are near to a portion where potential variations are extreme.	When measuring high impedance such as OPEN correction, electrostatic-shield the signal lines or ensure adequate distance from noise sources. Ground the case and peripheral conductors. When signal level is small or in a range of over 10kHz to 20kHz, the device is likely to be interfered.
Measurement is slow	Refreshing of display is slow. Or, same measured value is obtained repeatedly, and thus the measured value does not change.	There is no corrective action. When the measurement speed is fast, <b>ZM2371 / ZM2372</b> thins out and displays the measured results so that the measured values can be read appropriately. The measurement itself is executed at the specified speed.
	Averaging is executed.	Check the setting of averaging count, and set it to 1 if the averaging is not necessary.
	Long delay time is set.	Check the trigger delay time, and set it to minimum necessary value. When the trigger source is internal, set it to initial value (8ms) or zero.
	The measurement range is switched by the range automatic selection function. The measurement range is not determined due to a noise or contact failure.	When many DUTs having almost same value are measured, set the measurement range to HOLD. Long measurement range switching time has been set to reduce the wear of range switching relay.

## 8. MAINTENANCE

8.1	Introduction .....	8-2
8.2	Daily Maintenance.....	8-2
8.3	Storage, Repacking, and Transportation .....	8-2
8.4	Checking Version Number.....	8-3
8.5	Checking Isolation.....	8-3
8.6	Checking the Contact Check Function .....	8-3
8.7	Performance Testing .....	8-4
8.7.1	Measurement Frequency Accuracy .....	8-4
8.7.2	Measurement Signal Level Accuracy.....	8-4
8.7.3	Voltage Monitor Accuracy.....	8-5
8.7.4	DC Bias Voltage Accuracy.....	8-6
8.7.5	AC Impedance Measurement Accuracy.....	8-7
8.7.6	DC Resistance Measurement Accuracy .....	8-11
8.8	Calibration.....	8-12

## 8.1 Introduction

The following maintenance is essential for using the device under the best condition.

- Operation inspection: Check if the device operates properly.
- Performance testing: Check if the device respects the rated values.
- Adjustment, calibration: If the rated values are not satisfying, NF Corporation will make the necessary adjustment or calibration to restore performance.
- Damage repairs: When performance cannot be restored by the adjustment or calibration, NF Corporation will identify the cause and location of the damage and will execute repairs.

This instruction manual describes how to easily proceed with a performance testing.

For more accurate inspections, adjustments, calibration or repairs, contact NF Corporation or one of our representatives.

The following measurement instrument and standard are needed for the performance test:

- Frequency counter: Accuracy: within  $\pm 10 \times 10^{-6}$
- AC voltmeter: RMS value display, accuracy: within  $\pm 0.5\%$  (120Hz, 1kHz), within  $\pm 1\%$  (100kHz)
- DC voltmeter: Accuracy:  $\pm(0.5\% + 0.3\text{mV})$  (10V range)
- Multimeter: Should be able to make a diode test for measuring the voltage at 1mA in test current
- Standard capacitor: 10pF, 100pF, 1nF, 10nF, 100nF, 1 $\mu$ F (whose capacitance and dissipation factor should be calibrated at 120Hz, 1kHz, 10kHz, 100kHz)
- Standard resistor: 10m $\Omega$ , 100m $\Omega$ , 1 $\Omega$ , 10 $\Omega$ , 100 $\Omega$ , 1k $\Omega$ , 10k $\Omega$ , 100k $\Omega$ , 1M $\Omega$ , 10M $\Omega$  (whose DC resistance value should be calibrated, For the Standard resistor to be used for accuracy test of AC impedance, its impedance should be calibrated at 120Hz, 1kHz, 10kHz and 100kHz.)

## 8.2 Daily Maintenance

Install **ZM2371 / ZM2372** in a location that fills the installation requirements.

Installation conditions ☞ **“2.2.2 Installation Conditions”**

When the case/panel surface needs cleaning, wipe with a soft cloth. To remove persistent contamination, wipe with a soft cloth soaked with neutral detergent and wrung out.

Do not use any organic solvents like thinner or benzene, or any chemical cleaning cloth, as they may cause the surface finish to deteriorate, tarnish, or come off.

## 8.3 Storage, Repacking, and Transportation

Store **ZM2371 / ZM2372** in a location that fills the installation requirements.

Installation conditions ☞ **“2.2.2 Installation Conditions”**

When repacking is necessary, for transportation for example, use a case that is of sufficient size and strength, use filling that can withstand the weight of the device and make sure the device is sufficiently protected.

During transportation, handle the device, taking care not to apply strong shocks to the device.

## 8.4 Checking Version Number

The version number of **ZM2371 / ZM2372** firmware is displayed after power-on.

Version display      ☞ “3.2.2 Displays and Indications at Power “ON” ”

It is also to read out the version number by means of \*IDN? (Query).

About commands      ☞ “5.6.3.1 Common Commands”

Also check the test pattern (full dot display pattern) and the lamp for its full lighting that are displayed after power-on.

## 8.5 Checking Isolation

Remove all power cord, cable and etc of **ZM2371 / ZM2372** to separate it from others. Fix the measurement range of multimeter to the range, which can be measured by the specified test current. Set the multimeter to diode test mode (test current 1mA), and measure between the outer conductor of each BNC connector on front panel of **ZM2371 / ZM2372** and the earth terminal (case) at lower left.

Make sure that the voltage is within the range stated below. When out of this range, it might be possibly damaged.

- HCUR vs. Case    0.4 to 0.8V (approx 0.6V)      The value in ( ) shows the typical value
- HPOT vs. Case    0 to 0.1V (approx 7mV)            at room temperature.
- LPOT vs. Case    0 to 0.1V (approx 7mV)
- LCUR vs. Case    0 to 0.1V (approx 0mV)

## 8.6 Checking the Contact Check Function

To use the contact check function of **ZM2372**, initialize it by the operation of **[SHIFT] + [INIT]**, **[1] Key** and then enable the contact check function by the operation of **[SHIFT] + [CONTACT]**, **[1] Key** so that contact check function can be checked.

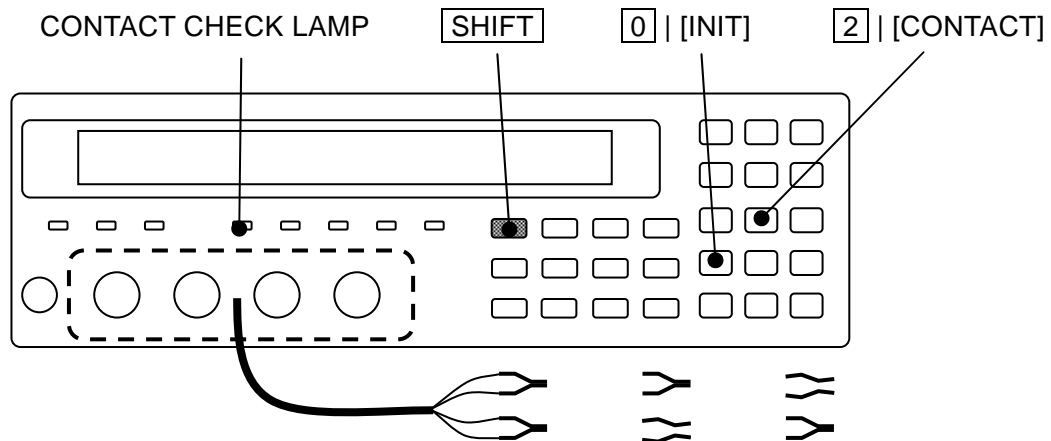

Mount the kelvin clip test lead on the measurement terminal, and make sure that measurement value normally displays when both sides of space between H terminals and space between L terminals are closed, meanwhile, NC (No Contact) displays as measurement value when either side of the above is opened.

## 8.7 Performance Testing

Performance testing is conducted as part of preventive maintenance to prevent performance degradation of the **ZM2371/ZM2372**. Besides, conduct it if needed after acceptance inspection, periodic inspection or repair.

If the result of a performance testing does not meet the specifications, calibration or repair is required. Contact NF Corporation or one of our representatives.

The performance testing should be conducted in the following conditions.

- Power voltage: 100 to 230V  $\pm$ 10% (250V or less)
- Ambient temperature: 23 $\pm$ 5C°
- Ambient humidity: 20 to 70%RH, non-condensing
- Warm up: 30 min or more
- Operation mode: 0: Set it with refer to **“6.1 Outline and Switching of Operation Mode”**.

Take the following precautions when you conduct a performance testing.

- The setting contents for each test item contains the descriptions of items which should be further changed after initializing the setting.

Setting the initialize  **“3.5.4 Initialization”** SHIFT + [INIT], 1 Key operation

### 8.7.1 Measurement Frequency Accuracy

Connection: H<sub>CUR</sub> terminal → Frequency counter input

Setting: After the initializing operation (SHIFT + [INIT], 1 Key operation), set the measurement frequency 1kHz (initial value) and measurement signal level 1Vrms (initial value).

Measurement: Measure the frequency with the frequency counter.

Evaluation: If the values on the counter are within the preset value $\pm$ 100ppm (0.999900kHz to 1.000100kHz), it is normal.

### 8.7.2 Measurement Signal Level Accuracy

Connection: H<sub>CUR</sub> terminal → AC voltmeter input

The cable length should be approx 1m or less.

Setting: After initializing the setting, set the measurement frequency and measurement signal level according to the contents in table stated below.

Measurement: Measure the output voltage with the AC voltmeter.

Evaluation: If the values indicated on AC voltmeter are within the specification range in table, it is normal.

		Measurement frequency			
		120Hz	1kHz	10kHz	100kHz
		Values indicated on AC voltmeter Specification: $\pm$ (10% + 5mVrms)			
Measurement signal level	0.1Vrms	85mVrms to 115mVrms			
	1Vrms	0.895 Vrms to 1.105 Vrms			
	5Vrms	4.495Vrms to 5.505 Vrms			

**8.7.3 Voltage Monitor Accuracy**

Connection: H<sub>CUR</sub> and H<sub>POT</sub> terminals together → AC voltmeter input (– terminal)  
 L<sub>CUR</sub> and L<sub>POT</sub> terminals together → AC voltmeter input (+ terminal)  
 For the connection, use kelvin test lead or coaxial cable.  
 To use the coaxial cable, connect 4 shields all together.  
 The cable length should be approx 1m or less in total length.

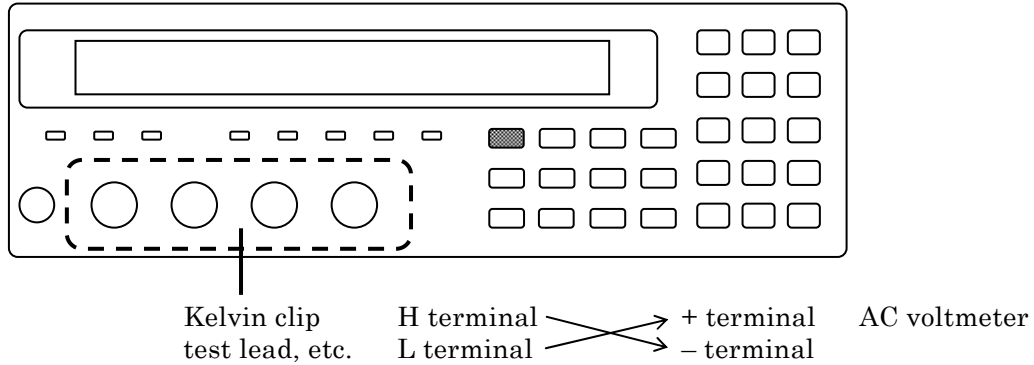

For the multimeter, which is activated by AC power, if large capacitance to earth is connected to L terminal, LCR meter gets unstable and correct measurement may not be done. Therefore, we recommend you to connect +/- inversely. If it is possible to make correct measurement, no need to connect inversely.

Setting: After initializing the setting, set the measurement frequency and measurement signal level according to the contents in table stated below. Press the **AUX DISP** key to display the auxiliary display selection menu, and switch the auxiliary display into current monitor value and Voltage monitor value.

Measurement: Measure the output voltage under each condition with the AC voltmeter.

Evaluation: If the values of voltage monitor are within the specification range in table for the specified values of voltmeter, it is normal.

		Frequency			
		120Hz	1kHz	10kHz	100kHz
		Spec. : ±(2% + 2mVrms)		Spec. : ±(3.5% + 2mVrms)	
Measurement signal level	0.1Vrms	Monitor	Spec. ± 4.0 Difference: mVrms	Monitor	Spec. ± 5.5 Difference: mVrms
		Voltmeter		Voltmeter	
	1Vrms	Monitor	Spec. ± 22 Difference: mVrms	Monitor	Spec. ± 37 Difference: mVrms
		Voltmeter		Voltmeter	
	5Vrms	Monitor	Spec. ± 102 Difference: mVrms	Monitor	Spec. ± 177 Difference: mVrms
		Voltmeter		Voltmeter	

### 8.7.4 DC Bias Voltage Accuracy

Connection: H<sub>CUR</sub> and H<sub>POT</sub> terminals together → AC voltmeter input (– terminal)  
 L<sub>CUR</sub> and L<sub>POT</sub> terminals together → AC voltmeter input (+ terminal)  
 For the connection, use kelvin test lead or coaxial cable.  
 To use the coaxial cable, connect 4 shields all together.  
 The cable length should be approx 1m or less in total length.

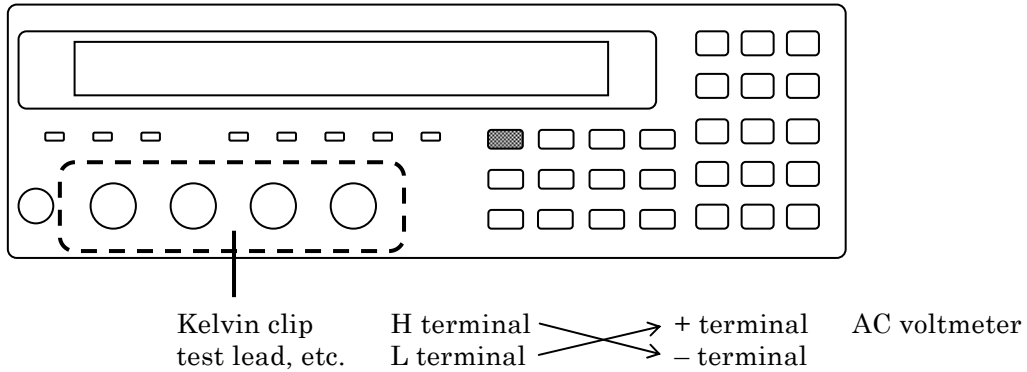

Setting: After initializing the setting, set the measurement frequency to 1kHz and the measurement signal level to 0.1Vrms.  
 Press the **BIAS** key to display the DC Bias setting menu, and turn on the DC Bias. Set the DC Bias voltage according to the contents in table stated below in order of precedence.

Measurement: Measure the DC Bias voltage with the DC voltmeter which is fixed at 10V range.

Evaluation: If the values on DC voltmeter are within the specification range of table, it is normal.

		Values indicated on DC voltmeter Spec. : ± (5% + 3mV)
DC Bias voltage	0.00V	-0.0030 V to +0.0030 V
	1.00V	-1.0530 V to -0.9470 V
	2.50V	-2.628 V to -2.372 V

Note: The polarity is inversed due to the connection.



### 8.7.5 AC Impedance Measurement Accuracy

Described here is the easy checking method. For the correct test, request NF Corporation to make test.

- Standard:** To make correct test, prepare the standard with approx 1/3 or less in calibration accuracy against the accuracy of **ZM2371 / ZM2372**.  
 Unless there is standard, prepare the standard stabilized specimen which was corrected by the precise measurement instrument. You can conduct the test depending on the calibration accuracy and stability factor of the standard provided. For the measurement of low impedance, it may suffer an influence of contact resistance. Accordingly, use the standard of 4-terminal structure.  
 The pseudo-capacitance standard with transformer cannot be used for **ZM2371 / ZM2372**. If standard having extremely large capacitance to earth (to shield) is used, LCR meter gets unstable, disabling the measurement. Compared with the normal parts, the standard capacitor with large capacitance to shield may cause a considerable error at high frequency and high impedance range.
- Reference:** For the range of approx 10Ω to 1MΩ having a good frequency response, even the resistor for which calibration value of impedance is not provided at each frequency can make a simple test using the calculated values stated below. Especially, for the shunt resistor with a good frequency response, the calculated values can be used even for 1Ω or 100mΩ in the same manner.
- Calibration value Rdc of DC resistance
  - Equivalent series inductance Ls[H] at 1MHz or E quivalent parallel capacitance Cp[F]
- Complex impedance  $\dot{Z} = Rdc + j \omega Ls$  or  $\dot{Z} = Rdc - j 1/(\omega Cp)$   
 $|\dot{Z}| = \sqrt{(Rdc^2 + (\omega Ls)^2)}$  or  $|\dot{Z}| = \sqrt{(Rdc^2 + 1/(\omega Cp)^2)}$   
 $\theta (= \angle \dot{Z}) = \tan^{-1}(\omega Ls / Rdc)$  or  $\theta = - \tan^{-1}(\omega Cp Rdc)$   
 where angular frequency  $\omega = 2 \pi f$ , f is frequency [Hz]
- Connection:** Standard → **ZM2371 / ZM2372** measurement terminal
- Setting:** After initializing the setting, setting as shown below.  
 Measurement frequency = 120Hz, 1kHz, 10kHz, 100kHz  
 Measurement signal level = 1V (initial value)  
 Measurement speed = SLOW, Averaging count = 1 (initial value)  
 Cable length correction = 0m (initial value) or Set depending on the cable used.  
 Measurement range = Fix it to the specified range.  
 Auto selection may not allow the specified measurement range. Accordingly, be sure to fix it to the specified measurement range.
- Measurement:** First, measures the open correction and short correction.  
 Thereafter, measure the standard according to the contents in table shown below.
- Evaluation:** If the measurement values are within the range stated below, it is approximately correct.  
 Calibration value of standard  $\pm$ (Calibration accuracy of standard + accuracy of **ZM2371 / ZM2372**)

## 8.7 Performance Testing

Described here is one example of test where easy-to-available standard is used.

The values in the following table are calculated based on the fact that calibration value of standard is equal to the nominal value, and are rounded to 2-digit in significant digit.

Insufficient calibration accuracy of standard may allow the difference to get out of range of the specification.

Measurement frequency 120kHz, Measurement signal level 1 Vrms, Cable length 0m

Measurement range	Standard (nominal value)	Calibration value of standard "A"		Measurement value "B"		Difference	Specification
						$100 \times (B - A) / A$	
						B-A	
1M $\Omega$	1000pF	C	F	C	F	C %	C $\pm$ 0.19 %
		D		D		D	D $\pm$ 0.0019
100k $\Omega$	0.01 $\mu$ F	C	F	C	F	C %	C $\pm$ 0.18 %
		D		D		D	D $\pm$ 0.0018
10k $\Omega$	0.1 $\mu$ F	C	F	C	F	C %	C $\pm$ 0.18 %
		D		D		D	D $\pm$ 0.0018
1k $\Omega$	1 $\mu$ F	C	F	C	F	C %	C $\pm$ 0.18 %
		D		D		D	D $\pm$ 0.0018
100 $\Omega$	100 $\Omega$	Z	$\Omega$	Z	$\Omega$	Z %	Z $\pm$ 0.17 %
		$\theta$	$^{\circ}$	$\theta$	$^{\circ}$	$\theta$ $^{\circ}$	$\theta$ $\pm$ 0.10 $^{\circ}$
10 $\Omega$	10 $\Omega$	Z	$\Omega$	Z	$\Omega$	Z %	Z $\pm$ 0.19 %
		$\theta$	$^{\circ}$	$\theta$	$^{\circ}$	$\theta$ $^{\circ}$	$\theta$ $\pm$ 0.11 $^{\circ}$
1 $\Omega$	1 $\Omega$	Z	$\Omega$	Z	$\Omega$	Z %	Z $\pm$ 0.27 %
		$\theta$	$^{\circ}$	$\theta$	$^{\circ}$	$\theta$ $^{\circ}$	$\theta$ $\pm$ 0.16 $^{\circ}$
100m $\Omega$	100m $\Omega$	Z	$\Omega$	Z	$\Omega$	Z %	Z $\pm$ 0.43 %
		$\theta$	$^{\circ}$	$\theta$	$^{\circ}$	$\theta$ $^{\circ}$	$\theta$ $\pm$ 0.25 $^{\circ}$

Measurement frequency 1kHz, Measurement signal level 1 Vrms, Cable length 0m

Measurement range	Standard (nominal value)	Calibration value of standard "A"		Measurement value "B"		Difference (ditto)	Specification
1M $\Omega$	100pF	C	F	C	F	C %	C $\pm$ 0.18 %
		D		D		D	D $\pm$ 0.0018
100k $\Omega$	1000pF	C	F	C	F	C %	C $\pm$ 0.11 %
		D		D		D	D $\pm$ 0.0011
10k $\Omega$	0.01 $\mu$ F	C	F	C	F	C %	C $\pm$ 0.09 %
		D		D		D	D $\pm$ 0.00086
1k $\Omega$	0.1 $\mu$ F	C	F	C	F	C %	C $\pm$ 0.09 %
		D		D		D	D $\pm$ 0.00086
100 $\Omega$	1 $\mu$ F	C	F	C	F	C %	C $\pm$ 0.09 %
		D		D		D	D $\pm$ 0.00086
10 $\Omega$	10 $\Omega$	Z	$\Omega$	Z	$\Omega$	Z %	Z $\pm$ 0.13 %
		$\theta$	$^{\circ}$	$\theta$	$^{\circ}$	$\theta$ $^{\circ}$	$\theta$ $\pm$ 0.075 $^{\circ}$
1 $\Omega$	1 $\Omega$	Z	$\Omega$	Z	$\Omega$	Z %	Z $\pm$ 0.23 %
		$\theta$	$^{\circ}$	$\theta$	$^{\circ}$	$\theta$ $^{\circ}$	$\theta$ $\pm$ 0.13 $^{\circ}$
100m $\Omega$	100m $\Omega$	Z	$\Omega$	Z	$\Omega$	Z %	Z $\pm$ 0.39 %
		$\theta$	$^{\circ}$	$\theta$	$^{\circ}$	$\theta$ $^{\circ}$	$\theta$ $\pm$ 0.22 $^{\circ}$

## 8.7 Performance Testing

Measurement frequency 10kHz, Measurement signal level 1 Vrms, Cable length 0m

Measurement range	Standard (nominal value)	Calibration value of standard "A"		Measurement value "B"		Difference $100 \times (B-A)/A$		Specification
						B-A		
1M $\Omega$	10pF	C	F	C	F	C	%	$C \pm 0.83 \%$
		D		D		D		$D \pm 0.0083$
100k $\Omega$	100pF	C	F	C	F	C	%	$C \pm 0.29 \%$
		D		D		D		$D \pm 0.0029$
10k $\Omega$	1000pF	C	F	C	F	C	%	$C \pm 0.19 \%$
		D		D		D		$D \pm 0.0019$
1k $\Omega$	0.01 $\mu$ F	C	F	C	F	C	%	$C \pm 0.18 \%$
		D		D		D		$D \pm 0.0018$
100 $\Omega$	0.1 $\mu$ F	C	F	C	F	C	%	$C \pm 0.18 \%$
		D		D		D		$D \pm 0.0018$
10 $\Omega$	1 $\mu$ F	C	F	C	F	C	%	$C \pm 0.21 \%$
		D		D		D		$D \pm 0.0021$
1 $\Omega$	1 $\Omega$	Z	$\Omega$	Z	$\Omega$	Z	%	$Z \pm 0.40 \%$
		$\theta$	$^\circ$	$\theta$	$^\circ$	$\theta$	$^\circ$	$\theta \pm 0.23^\circ$
100m $\Omega$	100m $\Omega$	Z	$\Omega$	Z	$\Omega$	Z	%	$Z \pm 0.68 \%$
		$\theta$	$^\circ$	$\theta$	$^\circ$	$\theta$	$^\circ$	$\theta \pm 0.39^\circ$

Measurement frequency 100kHz, Measurement signal level 1 Vrms, Cable length 0m

Measurement range	Standard (nominal value)	Calibration value of standard "A"		Measurement value "B"		Difference (ditto)		Specification
100k $\Omega$	100k $\Omega$	Z	$\Omega$	Z	$\Omega$	Z	%	$Z \pm 1.2 \%$
		$\theta$	$^\circ$	$\theta$	$^\circ$	$\theta$	$^\circ$	$\theta \pm 0.67^\circ$
10k $\Omega$	10k $\Omega$	Z	$\Omega$	Z	$\Omega$	Z	%	$Z \pm 0.86 \%$
		$\theta$	$^\circ$	$\theta$	$^\circ$	$\theta$	$^\circ$	$\theta \pm 0.49^\circ$
1k $\Omega$	1k $\Omega$	Z	$\Omega$	Z	$\Omega$	Z	%	$Z \pm 0.33 \%$
		$\theta$	$^\circ$	$\theta$	$^\circ$	$\theta$	$^\circ$	$\theta \pm 0.19^\circ$
100k $\Omega$	10pF	C	F	C	F	C	%	$C \pm 1.4 \%$
		D		D		D		$D \pm 0.014$
10k $\Omega$	100pF	C	F	C	F	C	%	$C \pm 0.90 \%$
		D		D		D		$D \pm 0.0090$
1k $\Omega$	1000pF	C	F	C	F	C	%	$C \pm 0.35 \%$
		D		D		D		$D \pm 0.0035$
100 $\Omega$	0.01 $\mu$ F	C	F	C	F	C	%	$C \pm 0.35 \%$
		D		D		D		$D \pm 0.0035$
10 $\Omega$	0.1 $\mu$ F	C	F	C	F	C	%	$C \pm 0.55 \%$
		D		D		D		$D \pm 0.0055$
1 $\Omega$	1 $\mu$ F	C	F	C	F	C	%	$C \pm 1.1 \%$
		D		D		D		$D \pm 0.011$
100m $\Omega$	100m $\Omega$	Z	$\Omega$	Z	$\Omega$	Z	%	$Z \pm 3.5 \%$
		$\theta$	$^\circ$	$\theta$	$^\circ$	$\theta$	$^\circ$	$\theta \pm 2.0^\circ$

For 1k $\Omega$ , 10k $\Omega$ , or 100k $\Omega$  range, use the standard resistor calibrated by 100kHz, if available. Otherwise, use the standard capacitor. Use either one.

## 8.7 Performance Testing

Cable length 1m, Measurement frequency 100kHz, Measurement signal level 1 Vrms

Measurement range	Standard	Calibration value of standard "A"		Measurement value "B"		Difference $100 \times (B-A)/A$	Specification
						B-A	
100kΩ	100kΩ	Z	Ω	Z	Ω	Z %	$Z \pm 1.2 \%$
		$\theta$	°	$\theta$	°	$\theta$ °	$\theta \pm 0.67^\circ$
10kΩ	10kΩ	Z	Ω	Z	Ω	Z %	$Z \pm 0.86 \%$
		$\theta$	°	$\theta$	°	$\theta$ °	$\theta \pm 0.49^\circ$
1kΩ	1kΩ	Z	Ω	Z	Ω	Z %	$Z \pm 0.33 \%$
		$\theta$	°	$\theta$	°	$\theta$ °	$\theta \pm 0.19^\circ$
100kΩ	10pF	C	F	C	F	C %	$C \pm 1.4 \%$
		D		D		D	$D \pm 0.014$
10kΩ	100pF	C	F	C	F	C %	$C \pm 0.90 \%$
		D		D		D	$D \pm 0.0090$
1kΩ	1000pF	C	F	C	F	C %	$C \pm 0.35 \%$
		D		D		D	$D \pm 0.0035$

For 1kΩ, 10kΩ, or 100kΩ range, use the standard resistor calibrated by 100kHz, if available. Otherwise, use the standard capacitor. Use either one.

Cable length 2m, Measurement frequency 10kHz, Measurement signal level 1 Vrms

Measurement range	Standard	Calibration value of standard "A"		Measurement value "B"		Difference (ditto)	Specification
100kΩ	100pF	C	F	C	F	C %	$C \pm 0.29 \%$
		D		D		D	$D \pm 0.0029$
10kΩ	1000pF	C	F	C	F	C %	$C \pm 0.19 \%$
		D		D		D	$D \pm 0.0019$

Cable length 4m, Measurement frequency 1kHz, Measurement signal level 1 Vrms

Measurement range	Standard	Calibration value of standard "A"		Measurement value "B"		Difference (ditto)	Specification
100kΩ	1000pF	C	F	C	F	C %	$C \pm 0.11 \%$
		D		D		D	$D \pm 0.0011$

Measurement signal level 0.1 Vrms, Measurement frequency 1kHz, Cable length 0m

Measurement range	Standard	Calibration value of standard "A"		Measurement value "B"		Difference (ditto)	Specification
100kΩ	1000pF	C	F	C	F	C %	$C \pm 0.18 \%$
		D		D		D	$D \pm 0.0018$

Measurement signal level 5 Vrms, Measurement frequency 1kHz, Cable length 0m

Measurement range	Standard	Calibration value of standard "A"		Measurement value "B"		Difference (ditto)	Specification
100kΩ	1000pF	C	F	C	F	C %	$C \pm 0.14 \%$
		D		D		D	$D \pm 0.0014$

### 8.7.6 DC Resistance Measurement Accuracy

- Standard:** Prepare the standard resistor having the calibration accuracy approx 1/3 or less against the accuracy of **ZM2371 / ZM2372** besides the resistance value is up to  $\pm 1\%$  of those in the following table. Unless there is standard resistor, alternately use the stable resistor that was corrected by the precise measurement instrument. For the measurement of low resistance, use the standard resistor of 4-terminal structure to avoid an effect from contact resistance.
- Connection:** Standard resistance  $\rightarrow$  **ZM2371 / ZM2372** measurement terminal
- Setting:** After initializing the setting, setting as shown below.  
 Primary parameter = Z  
 Secondary parameter = Rdc  
 Measurement speed = SLOW, averaging count = 1 (initial value)  
 Measurement range of DC resistance = Auto selection (initial value, it cannot be fixed by manual)
- Measurement:** First measures the open correction and short correction. Thereafter, measure the standard resistance according to the contents in table shown below. Directly connect the standard with the measurement terminal of LCR meter (cable length= 0m).
- Evaluation:** If the measurement values are within the specification range in table, it is approximately normal.  
 If the calibration accuracy of standard resistance is insufficient, you can see as if the value goes beyond the specification range.

Measurement range of DC resistance	Standard resistance	Calibration value of standard resistance "A"	Measurement value "B"	Difference $100 \times (B - A) / A$	Specification (According to measurement range)
1M $\Omega$	10M $\Omega$	$\Omega$	$\Omega$	%	$\pm 0.37\%$
1M $\Omega$ 100k $\Omega$	1M $\Omega$	$\Omega$	$\Omega$	%	$\pm 0.16\%$ $\pm 0.22\%$
100k $\Omega$ 10k $\Omega$	100k $\Omega$	$\Omega$	$\Omega$	%	$\pm 0.13\%$ $\pm 0.19\%$
10k $\Omega$ 1k $\Omega$	10k $\Omega$	$\Omega$	$\Omega$	%	$\pm 0.10\%$ $\pm 0.19\%$
1k $\Omega$ 100 $\Omega$	1k $\Omega$	$\Omega$	$\Omega$	%	$\pm 0.10\%$ $\pm 0.19\%$
100 $\Omega$	100 $\Omega$	$\Omega$	$\Omega$	%	$\pm 0.10\%$
100 $\Omega$ 10 $\Omega$	10 $\Omega$	$\Omega$	$\Omega$	%	$\pm 0.19\%$ $\pm 0.14\%$
10 $\Omega$ 1 $\Omega$	1 $\Omega$	$\Omega$	$\Omega$	%	$\pm 0.32\%$ $\pm 0.19\%$
1 $\Omega$ 100m $\Omega$	100m $\Omega$	$\Omega$	$\Omega$	%	$\pm 0.67\%$ $\pm 0.47\%$
100m $\Omega$	10m $\Omega$	$\Omega$	$\Omega$	%	$\pm 3.4\%$

- Supplement:** When it is possible to fix the measurement range of DC resistance with the remote control, fix it to the optimal measurement range. Since it is impossible to fix by manual, display the Measurement range setting menu with the pressed "[SHIFT] + [RANGE] keys", and check the measurement range of DC resistance. You can verify the measurement accuracy at the measurement range you have checked.

## **8.8 Calibration**

If the performance test does not satisfy the specification, NF Corporation will make the necessary adjustment or calibration to recover the performance.

If calibration is necessary, contact NF Corporation or one of our representatives.

You will be liable for the costs of adjustment and calibration outside the warranty period.

## 9. SPECIFICATIONS

9.1 Specifications .....	9-2
9.2 External Dimensions .....	9-12

**Supplementary value:** This value implies supplementary data of the product and it does not guarantee the product performance.

## 9.1 Specifications

### ■ Measurement parameters

- Primary parameters  $|Z|$ ,  $|Y|$ , L, C, R, G  
For equivalent circuit of L, C, and R, Parallel / Series / Auto Selection are selectable.
- Secondary parameters Q, D,  $\theta$ , X, B, Rs, Rp, G, Lp, Rdc (direct-current resistance)
- Auto parameter selection Primary parameters (including equivalent circuit) and secondary parameters can be selected automatically.

### ■ Measured value display range

- $|Z|$  0.000m $\Omega$  to 999.999M $\Omega$
- R (Rs, Rp, Rdc), X 0 $\Omega$ ,  $\pm(0.001\text{m}\Omega$  to 999.999M $\Omega)$
- $|Y|$  0.00nS to 9.99999kS
- G, B 0S,  $\pm(0.01\text{nS}$  to 9.99999kS)
- C (Cp, Cs) 0F,  $\pm(0.00001\text{pF}$  to 999.999kF)  
ex. 0.000pF to 999.999mF (1kHz)  
0.00pF to 9.99999F (120Hz)
- L (Ls, Lp) 0H,  $\pm(0.001\text{nH}$  to 99.9999GH)  
ex. 0.0000 $\mu$ H to 99.9999kH (1kHz)
- Q, D 0,  $\pm(0.00001$  to 99999.9)
- $\theta$   $\pm 180.000^\circ$   
Actual measurement and display ranges of respective parameters are restricted by the measurement range or frequency.

### ■ Measurement conditions

- Measurement frequency 1mHz to 100kHz, Resolution 5 digits (1mHz when  $< 10\text{Hz}$ ),  $\pm 0.01\%$
- Measurement signal level 10mV to 5.00V, Resolution 3 digits (1mV when  $< 100\text{mV}$ ),  $\pm(10\% + 5\text{mV})$   
RMS value when output is open
- ALC Constant voltage drive / Constant current drive / Invalid  
Voltage setting range 10mV to 5.00V, Setting resolution 3 digits (1mV when  $< 100\text{mV}$ )  
Current setting range 1 $\mu$ A to 200mA, Setting resolution 3 digits (0.1 $\mu$ A when  $< 10\mu\text{A}$ )  
The constant control range will be narrower than the above specifications depending on the product dispersion or DUT's impedance.  
The current range is restricted depending on the measurement range.
- Output impedance 5 $\Omega$  / 25 $\Omega$  / 100 $\Omega$  (supplementary values). Automatically selected according to the measurement range.  
5 $\Omega$  is selected automatically only when the following conditions are satisfied:  
Minimum output impedance setting = 5 $\Omega$ ,  
Measurement range  $\leq 10\Omega$ ,  
Measurement signal level  $\leq 1\text{V}$ , ALC = invalid,  
Internal DC bias = Off, Secondary parameter  $\neq \text{Rdc}$
- Internal DC bias 0V to +2.50V, Resolution 0.01V,  $\pm(5\% + 3\text{mV})$  when output is open  
On/Off is possible



- Trigger source INT Internal (automatic continuous trigger)  
MAN Manual  
EXT Handler interface  
BUS Remote control
- Trigger delay time Setting range 0.000s to 999.999s, Resolution 0.001s  
(Time after input of trigger until start of signal acquisition)
- Triggered drive Drive only at measurement / Continuous drive selectable  
(Measurement signal can be output only during the time from trigger to completion of signal acquisition)
- Measurement speed RAPid / FAST / MEDium / SLOW / VerySLOW  
Typical measurement time  
(Supplementary value. Time from input of trigger to output of measurement end signal EOM)

Measurement frequency	RAP	FAST	MED	SLOW	VSLO
120Hz	10ms	10ms	26ms	126ms	501ms
1kHz	2ms	5ms	25ms	121ms	501ms
10kHz	3ms	5ms	25ms	122ms	502ms
100kHz	3ms	5ms	25ms	122ms	502ms

Conditions: Measurement range fixed, Trigger delay time = 0, Averaging count = 1, Secondary parameter ≠ Rdc  
Signal acquisition time is the value subtracted by about 1ms from the above value.

DUT can be replaced immediately after the completion of signal acquisition.

After replacement of DUT, the signal settling time is required additionally.

Additional time when measuring direct-current resistance Rdc (supplementary value)

	RAP	FAST	MED	SLOW	VSLO
(DC)	148ms	148ms	148ms	215ms	613ms

Conditions: DC resistance measurement range fixed, Trigger delay time = 0, Averaging count = 1

- Measurement range

Measurement range	Recommended range	Measurable range
1MΩ	1MΩ to 11MΩ	≥ 900kΩ
100kΩ	100kΩ to 1.1MΩ	≥ 90kΩ
10kΩ	10kΩ to 110kΩ	≥ 9kΩ
1kΩ	1kΩ to 11kΩ	≥ 0.9kΩ
100Ω	9Ω to 1.1kΩ	No limitation
10Ω	0.9Ω to 10Ω	≤ 11Ω
1Ω	90mΩ to 1Ω	≤ 1.1Ω
100mΩ	9mΩ to 100mΩ	≤ 110mΩ

Measurable range: Approximate range in which measurement and display are possible (supplementary value).

Recommended range: Recommended operating range for high accuracy measurement.

Limitation by frequency

When frequency > 20kHz, 1MΩ range cannot be used.

- Measurement range selection Auto / Manual

■ Measurement accuracy

• Basic accuracy 0.08%

• Impedance measurement accuracy

Z<sub>r</sub>: Measurement range (100mΩ to 1MΩ)

Z<sub>x</sub>: Measured value of impedance magnitude |Z|

With the above definition, the impedance measurement accuracy is obtained as follows:

Accuracy of impedance magnitude |Z| ±A<sub>z</sub> [%]

$$A_z = (A + B \times U + K_z + K_y) \times V \times K_T + K_B \times U$$

Accuracy of phase angle θ of impedance ±P<sub>z</sub> [°]

$$P_z = 0.573 \times A_z$$

The measurement accuracy when A<sub>z</sub> exceeds 10 [%] is a supplementary value.

The measurement accuracy of the measured value smaller than half the lower limit of each recommended measurement range or larger than twice the upper limit is a supplementary value.

Each parameter value in the expression is listed below.

• U: Ratio coefficient

Z <sub>x</sub>	U
> 100Ω	Z <sub>x</sub> / Z <sub>r</sub> (however, 1 when Z <sub>x</sub> / Z <sub>r</sub> < 1)
≤ 100Ω	Z <sub>r</sub> / Z <sub>x</sub> (however, 1 when Z <sub>r</sub> / Z <sub>x</sub> < 1)

• V: Signal level coefficient

Measurement signal level [V <sub>rms</sub> ]	V											
	Z <sub>r</sub> = 1MΩ, 100kΩ (> 20kHz)			Z <sub>r</sub> = 100kΩ (≤ 20kHz), 10kΩ, 1kΩ, 100Ω)			Z <sub>r</sub> = 10Ω, 1Ω			Z <sub>r</sub> = 100mΩ		
2 < Level ≤ 5	1.3	1.3	1.3	1.3	1.3	1.3	1.3	1.3	1.3	3	2	1.3
1 < Level ≤ 2	1.2	1.2	1.2	1.2	1.2	1.2	1.2	1.2	1.2	1.8	1.5	1.2
1	1	1	1	1	1	1	1	1	1	1	1	1
0.5 < Level < 1	1.4	1.2	1.2	1.4	1.2	1.2	1.5	1.5	1.2	2.5	2	1.2
0.2 < Level ≤ 0.5	1.4	1.3	1.3	1.4	1.3	1.3	2.5	2.2	1.3	3 3 1.3 × (0.5V <sub>rms</sub> / Meas. signal level [V <sub>rms</sub> ])		
0.1 < Level ≤ 0.2	2.2	2.2	1.4	1.4	1.4	1.4	3.5	3.5	1.4			
0.05 < Level ≤ 0.1	2.5	2.5	1.6	1.8	1.6	1.6	× (0.2V <sub>rms</sub> / Meas. signal level [V <sub>rms</sub> ])					
0.02 < Level ≤ 0.05	× (0.1V <sub>rms</sub> / Meas. signal level [V <sub>rms</sub> ])			4	2.8	2						
0.01 ≤ Level ≤ 0.02				8	5	3						

Three coefficients in each column are applied to the measurement speeds RAP, FAST, MED from the left in order.

The coefficient for measurement speeds SLOW and VSLO is same as MED.

For FAST, the coefficient of MED is applied when measurement frequency ≤ 40Hz.

For RAP, the coefficient of FAST when measurement frequency ≤ 250Hz, or that of MED when measurement frequency ≤ 40Hz is applied.

The coefficient varies depending on the frequency when measurement range Z<sub>r</sub> = 100kΩ. At all times, V = 1 for the direct-current resistance R<sub>dc</sub>.

• **K<sub>Z</sub>: Residual impedance coefficient**

Frequency	K <sub>Z</sub> [%]
DC (0Hz), Frequency ≤ 120Hz	$(0.003 + K_c) / Z_x[\Omega]$
120Hz < Frequency ≤ 1kHz	$(0.005 + K_c) / Z_x[\Omega]$
1kHz < Frequency ≤ 10kHz	$(0.005 + 0.002 \times \text{Frequency [kHz]} + K_c) / Z_x[\Omega]$
10kHz < Frequency ≤ 100kHz	$(0.0025 \times \text{Frequency [kHz]} + K_c) / Z_x[\Omega]$

Cable length coefficient  $K_c = 0.001 \times \text{Frequency [kHz]} \times (\text{Cable length [m]})^2$

• **K<sub>Y</sub>: Residual admittance coefficient**

Frequency	K <sub>Y</sub> [%]
DC, Frequency ≤ 120Hz	$Z_x[\Omega] / (3 \times 10^8)$
120Hz < Frequency ≤ 100kHz	$Z_x[\Omega] \times \text{Frequency [kHz]} / (3 \times 10^7)$

• **K<sub>T</sub>: Temperature-dependent coefficient**

Ambient temperature (T °C)	K <sub>T</sub>
0 to +18	$1 + 0.1 \times (18 - T)$
+18 to +28	1
+28 to +40	$1 + 0.1 \times (T - 28)$

• **K<sub>B</sub>: DC bias coefficient**

Internal DC bias	Measurement range Z <sub>r</sub>	K <sub>B</sub> [%]	
		Frequency ≤ 10kHz	Frequency >10kHz
Disabled	All ranges	0	0
Enabled	1MΩ	0.02	0.02
	100Ω to 100kΩ	0.003	0.01
	10Ω	0.03	0.05
	1Ω	0.3	0.5
	100mΩ	Measurement accuracy is not specified	

At all times,  $K_B = 0$  for the direct-current resistance R<sub>dc</sub>.

- **A (upper row): Basic coefficient [%]**
- **B (lower row): Proportional coefficient [%]**

Meas. speed	Meas. range Zr	Measurement frequency Hz								
		0 (DC)	99.999 ↑ 1m	999.99 ↑ 100	1k	1.9884k ↑ 1.0001k	10k ↑ 1.9885k	20k ↑ 10.001k	50k ↑ 20.001k	100k ↑ 50.001k
MED, SLOW, VSLO	1MΩ	0.14 0.02	0.50 0.30	0.15 0.025	0.10 0.02	0.15 0.03	0.25 0.03	0.25 0.03	–	–
	100kΩ	0.12 0.01	0.25 0.04	0.15 0.02	0.09 0.01	0.10 0.015	0.20 0.025	0.25 0.03	0.30 0.03	0.80 0.03
	10kΩ	0.09 0.01	0.20 0.03	0.15 0.02	0.07 0.01	0.09 0.01	0.16 0.015	0.20 0.02	0.25 0.03	0.80 0.03
	1kΩ	0.09 0.01	0.20 0.03	0.15 0.02	0.07 0.01	0.09 0.01	0.16 0.015	0.20 0.02	0.25 0.03	0.30 0.03
	100Ω	0.09 0.01	0.20 0.03	0.15 0.02	0.07 0.01	0.09 0.01	0.16 0.015	0.20 0.02	0.25 0.03	0.30 0.03
	10Ω	0.12 0.02	0.25 0.03	0.17 0.02	0.12 0.01	0.15 0.015	0.20 0.017	0.40 0.03	0.45 0.05	0.50 0.06
	1Ω	0.14 0.05	0.40 0.06	0.30 0.02	0.20 0.02	0.25 0.02	0.35 0.02	0.60 0.03	0.70 0.08	0.90 0.10
	100mΩ	0.14 0.30	0.60 0.40	0.30 0.10	0.30 0.04	0.30 0.04	0.40 0.03	0.60 0.06	0.90 0.10	0.90 0.10
FAST	1MΩ	Same as above	0.50 0.30	0.15 0.025	0.12 0.03	0.15 0.03	0.25 0.03	0.25 0.03	–	–
	100kΩ		0.25 0.04	0.15 0.02	0.09 0.01	0.10 0.015	0.20 0.025	0.25 0.03	0.30 0.03	0.80 0.03
	10kΩ		0.20 0.03	0.15 0.02	0.08 0.01	0.09 0.01	0.16 0.015	0.20 0.02	0.25 0.03	0.80 0.03
	1kΩ		0.20 0.03	0.15 0.02	0.08 0.01	0.09 0.01	0.16 0.015	0.20 0.02	0.25 0.03	0.30 0.03
	100Ω		0.20 0.03	0.15 0.02	0.08 0.01	0.09 0.01	0.16 0.015	0.20 0.03	0.25 0.03	0.30 0.03
	10Ω		0.25 0.03	0.17 0.02	0.13 0.015	0.15 0.02	0.20 0.02	0.40 0.08	0.45 0.08	0.50 0.08
	1Ω		0.40 0.06	0.30 0.02	0.22 0.025	0.25 0.03	0.35 0.03	0.60 0.20	0.70 0.20	0.90 0.20
	100mΩ		0.60 0.40	0.30 0.15	0.30 0.06	0.30 0.06	0.40 0.06	0.80 0.06	1.0 0.80	1.0 0.80
RAP	–	Same as above	For measurement frequency > 250Hz, multiply FAST value by 1.3. For measurement frequency ≤ 250Hz, use FAST value.							

• Other conditions

- Warm-up 30 minutes or more
  - Zero correction Execute open correction and short correction.
  - Cable length correction Execute according to the cable length.
- Measurement accuracy is not guaranteed in a range other than the following applicable frequency range.

Cable	Applicable frequency range
0m, 1m	All ranges including DC
2m	DC, Frequency $\leq 20\text{kHz}$
4m	DC, Frequency $\leq 1\text{kHz}$

Calibration cycle 1 year

• Measurement accuracy of measurement parameters except Z and  $\theta$

From the measurement accuracy of impedance, obtain as follows.  
 Here,  $Q_x$  is a measured value of Q,  $D_x$  is a measured value of D, and  $\theta_x$  is a measured value of  $\theta$ .  $\theta_x$  used for accuracy calculation may be obtained from  $(90^\circ - \tan^{-1} |1/Q_x|)$  or  $(90^\circ - \tan^{-1} |D_x|)$ .

Parameter	Measurement accuracy
Y	$\pm A_z$ [%]
$L_p, L_s, X$	$\pm A_z$ [%] ( $ Q_x  \geq 10$ ), $\pm A_z / \sin\theta_x$ [%] ( $ Q_x  < 10$ )
$C_p, C_s, B$	$\pm A_z$ [%] ( $ D_x  \leq 0.1$ ), $\pm A_z / \sin\theta_x$ [%] ( $ D_x  > 0.1$ )
$R_p, R_s, G$	$\pm A_z$ [%] ( $ Q_x  \leq 0.1$ ), $\pm A_z / \cos\theta_x$ [%] ( $ Q_x  > 0.1$ )
Rdc	$\pm A_z$ [%]
Q	$\pm Q_x^2 \times P_e / (1 -  Q_x  \times P_e)$ ( $ Q_x  \geq 10,  Q_x  \times P_e \leq 0.1$ ) Here, the phase angle error $P_e$ [rad] = $0.01 \times A_z$ [%]. It differs from $P_z$ [°]. Measurement accuracy of Q is absolute value. It is not a % value.
D	$\pm(0.01 \times A_z)$ ( $ D_x  \leq 0.1$ ) Measurement accuracy of D is absolute value. It is not a % value.

In general, a range of each measurement parameter (maximum value and minimum value) can be calculated based on an error circle of the impedance.

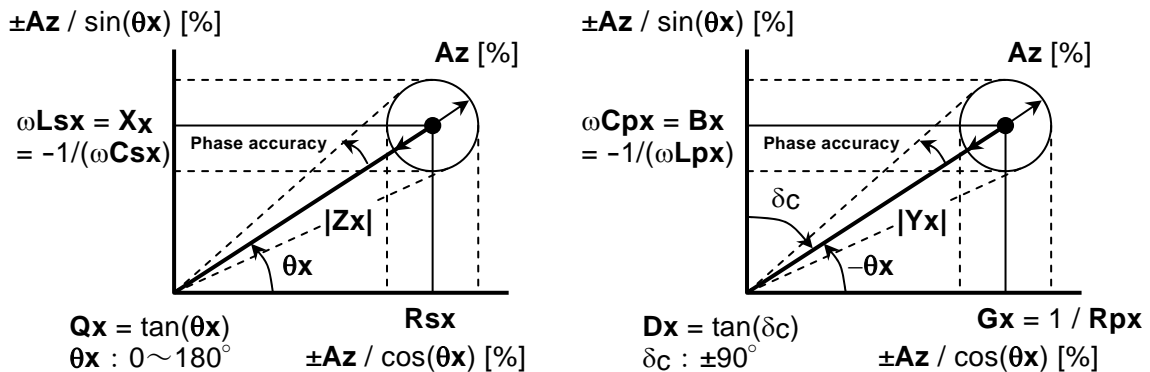

$\omega = 2 \times \pi \times$  Measurement frequency [Hz], Suffix "x" of the parameter indicates a measured value.

Figure 9-1 Range of error

Pure L [H] and C [F] can be converted into |Z| [Ω] by the following expression:

$$|Z| [\Omega] = 2 \times \pi \times \text{Frequency [Hz]} \times L [\text{H}]$$

$$|Z| [\Omega] = 1 / (2 \times \pi \times \text{Frequency [Hz]} \times C [\text{F}])$$

Approximate value can be read from the following graph.

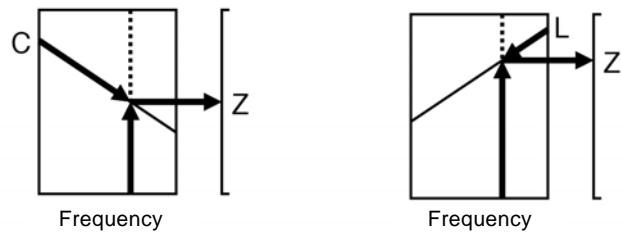
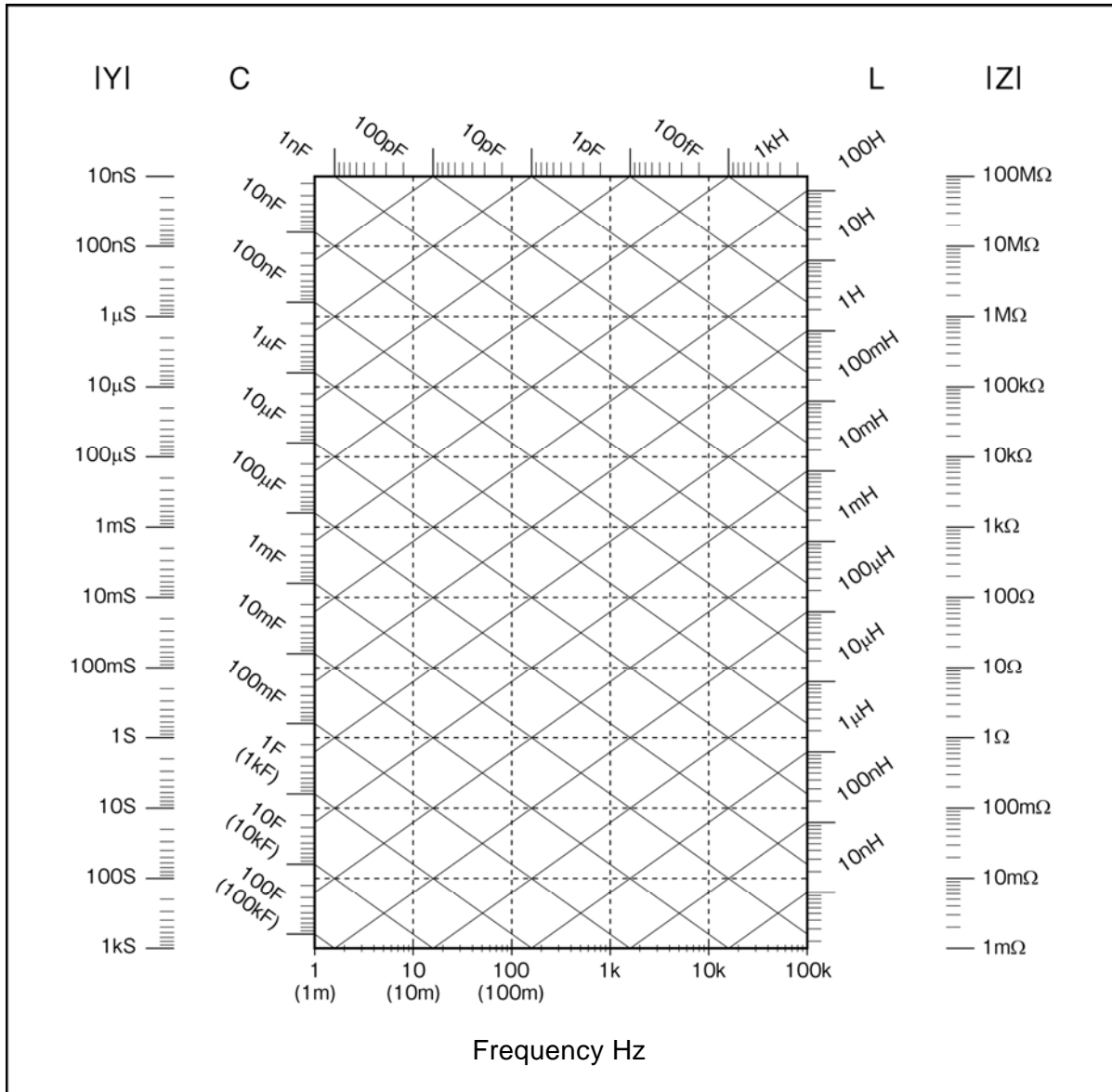

Figure 9-2 LC - Z conversion graph

### ■ Other measurement related functions

- Zero correction                    Open correction and short correction provided. Both can be turned on or off.
- Load correction                    Provided. It can be turned on or off.
- Cable length correction          0m / 1m / 2m / 4m
- Contact check                      (Standard for **ZM2372**. Not provided for **ZM2371**)  
For all 4 terminals, a contact failure to DUT is detected.  
Additional time 4ms (supplementary value)
- Averaging                            1 to 256 times
- Deviation measurement          Primary parameters:    Deviation and deviation % from reference value can be displayed.  
Secondary parameters: Deviation and deviation % from reference value can be displayed.
- Comparator                        Primary parameters:    Max. 9 bins (**ZM2371**) / Max. 14 bins (**ZM2372**)  
Original measured value / Deviation / Deviation % can be sorted.  
Secondary parameters: Upper limit and lower limit comparison  
Original measured value / Deviation / Deviation % can be sorted.  
Beeper:                    Sounds according to comparator result (Pass / Fail / Off)
- Handler interface                (Standard for **ZM2372**. Not provided for **ZM2371**)  
Signal isolation:            All I/O signals are optically isolated (withstand voltage  $\pm 42\text{V}$ )  
Input signals:                Trigger, Key lock, Settings/correction value memory designation  
Output signals:              Comparator result BIN1 to BIN11, NC / BIN12, PHI / BIN13, PLO / BIN14, OUT OF BINS, S-NG, ERR, INDEX, EOM (NC, PHI, and PLO cannot be used when BIN10 - BIN14 are used)  
Rated power voltage:        External +5V to +24V,  
Internal +5V (non- isolated)
- Monitor display                    Voltage: Voltage value applied to the DUT  
Voltage monitor accuracy  $\pm(2\%+2\text{mVrms})$     10Hz to 50kHz  
 $\pm(3.5\%+2\text{mVrms})$     50kHz <  
Current: Current value flowing in the DUT  
Current monitor accuracy (supplementary value)  
Voltage monitor accuracy + Measurement accuracy of impedance Z
- Discharge protection            8J or less when voltage is below 250V, or 1J or less when below 1kV.  
However, for output impedance  $5\Omega$ , below 250V and 2J or less.  
(All are supplementary values)

■ **Remote control interface**

- USB                      USBTMC, USB 1.1 full speed
- RS-232                    Data rate  
                                  4800 / 9600 / 19200 / 38400 / 57600 / 115200 / 230400bps  
                                  For the data rate exceeding 19200bps, communication may fail  
                                  depending on the characteristics of cable or controller.  
  
                                  Flow control  
                                  None, Software (X-ON/X-OFF), Hardware (RTS/CTS)
- GPIB (standard for **ZM2372**. Not provided for **ZM2371**)  
                                  Conforms to IEEE 488.1 and IEEE 488.2 Standards



■ **General specifications**

- Power supply
  - Voltage: AC 100V to 230V ±10%, but 250V or less
  - Frequency: 50Hz/60Hz ±2Hz
  - Power consumption: 70VA or less (**ZM2371**),  
75VA or less (**ZM2372**)
  - Over voltage category II
  
- Environmental conditions
  - Operation
    - Temperature: 0 to +40°C
    - Humidity: 5 to 85%RH Absolute humidity 1 to 25g/m<sup>3</sup>, non-condensing
    - Altitude: 2000m or less
  
  - Storage
    - Temperature: -10 to +50°C
    - Humidity: 5 to 95%RH Absolute humidity 1 to 29g/m<sup>3</sup>, non-condensing

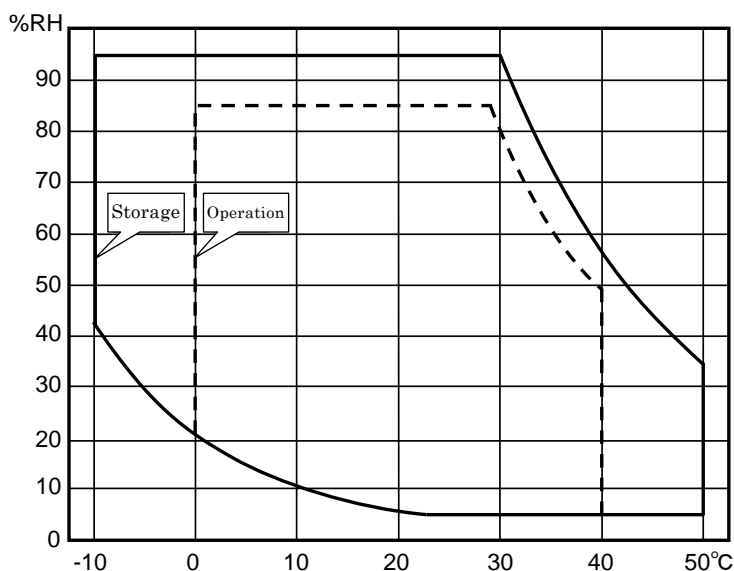

Pollution Degree 2 (indoor use)

- Warn-up time 30 minutes
- Settings/correction value memory 32 sets. Settings and correction values can be saved and restore individually or together.
- Resume Last setting and correction value are restore when power is turned on.
- Safety regulation EN 61010-1: 2001
- EMC EN 61326-1: 2006
- External dimensions Approx. 260 (W) × 88 (H) × 220 (D) mm, not including protuberances
- Weight Approx. 2.0kg (**ZM2371**), approx. 2.1kg (**ZM2372**) (not including accessories)

## 9.2 External Dimensions

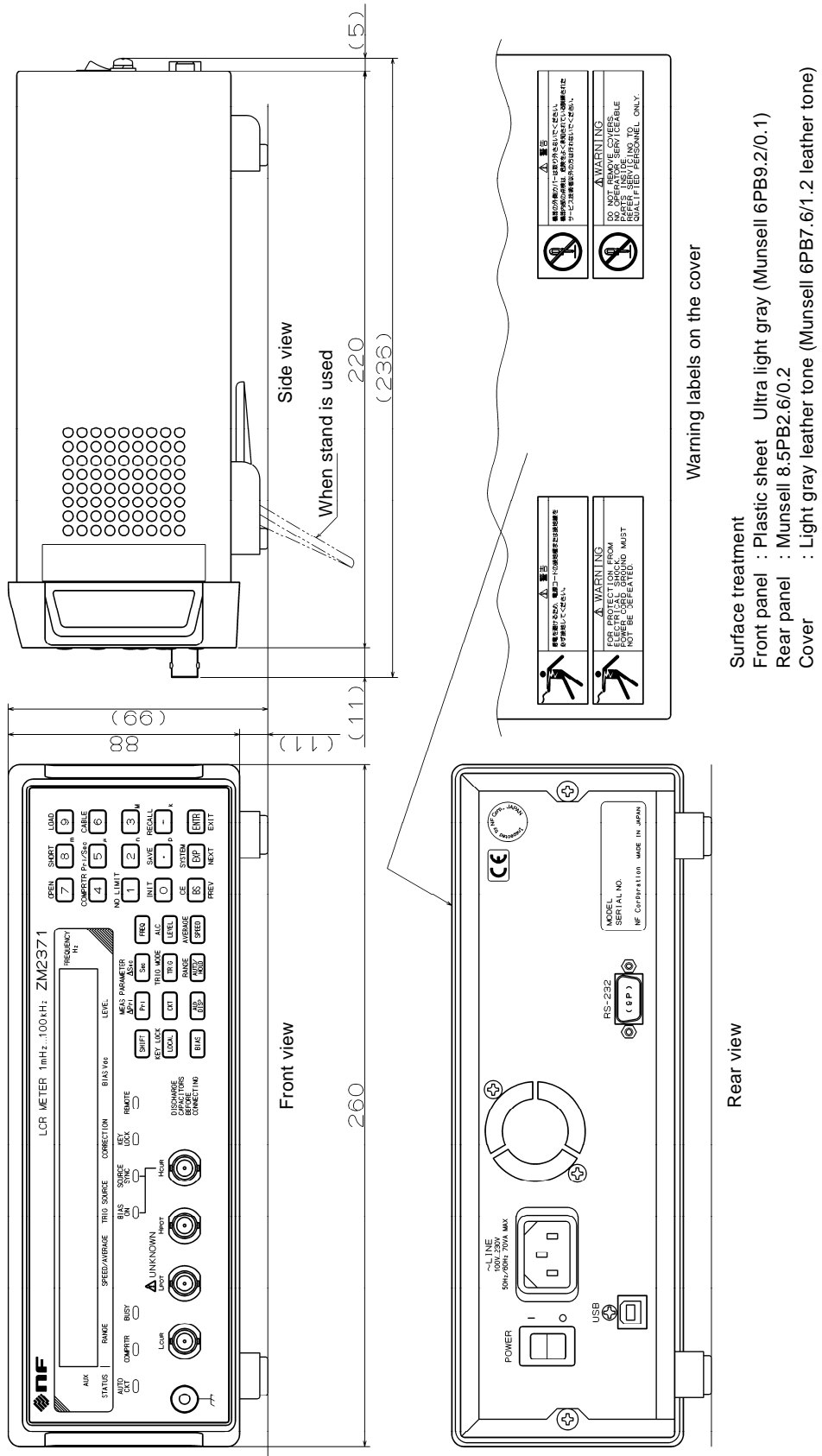

Figure 9-3 ZM2371 External dimensions





# WARRANTY

NF Corporation certifies that the **ZM2371 / ZM2372** was thoroughly tested and inspected when it was shipped from our factory.

If any failures attributable to defects in material and workmanship or accidents during transportation are found, please get in touch with NF Corporation or one of our representatives.

For the product purchased from NF Corporation or one of our representatives, any failures found to be caused by NF Corporation's responsibility such as parts failures that occurred under normal operating conditions or defects in material and workmanship shall be covered by the warranty for one year after the date of delivery. NF Corporation will repair such defective product free of charge, if the purchaser contacts NF Corporation or one of our representatives within the warranty period. This warranty is valid only in Japan. When the product is to be used outside Japan, please consult NF Corporation or one of our representatives.

Repair of defective product that occurred by either of the following causes shall be charged even within the warranty period.

- Failure due to the handling or storage that violates the operating methods or precautions given in the instruction manual
- Failure or damage caused by a fall or shock during transportation or relocation performed by the purchaser
- Modification made to the product by the purchaser
- Failure by external abnormal voltage or influence of external equipment connected to the product
- Failure or damage caused by fire, earthquake, flood, thunder, rebellion, war, and force majeure including other act of providence.
- Replenishment of consumable parts such as magnetic tapes and batteries

## REPAIR

When a failure occurred and the product was found to be defective or you have any uncertainty, please get in touch with NF Corporation or one of our representatives. In such a case, let us know the model name (or product name), serial number (SERIAL No. given on the nameplate), and symptom and operating conditions as detail as possible.

Though we will make efforts to reduce the repair period, when five or more years have passed since you purchased the product, it may take time due to, for instance, the out of stock of repair parts.

Also, if the production of repair parts is discontinued, the product is extremely damaged, or the product is modified, we may decline the repair.



---

## NOTES

---

- Reproduction of the instruction manual, part or whole, is forbidden without prior written permission.
- The contents of the instruction manual are subject to change without notice.
- Information provided in the instruction manual is intended to be accurate and reliable. However, we assume no responsibility for any damage regarding the contents of the instruction manual.

If you have any uncertainty or you found an error or omission, please contact NF Corporation or one of our representatives from which you purchased the product.

---

## **ZM2371 / ZM2372 Instruction Manual**

### **NF Corporation**

6-3-20 Tsunashima Higashi, Kohoku-ku, Yokohama  
223-8508, JAPAN

Phone: +81-45-545-8128 Fax: +81-45-545-8187

<http://www.nfcorp.co.jp/>

© Copyright 2009 **NF Corporation**







