

# LOW NOISE AMPLIFIER SA SERIES

*Accurate and ultra low noise measurements of very small signals  
Achieve one of the highest levels of low noise amplification*

## Current Amplifier

### SA-600 series



Up to  
1T V/A



## Voltage Amplifier

### SA-400 series

Differential input



### SA-200 series

Single-ended input

# NF Low Noise Amplifier Line-up that Performs High Quality Amplification of Small Signals.

In small signal measurement, it is extremely important how to faithfully amplify and optimally process the analog signal from the sensor. The SA lineup of low noise amplifiers pursue technology to minimize the factors that will interfere with measurement, such as noise and the influence of the surrounding environment.

## World-class low noise performance

### Voltage Amplifier

Eleven models for various applications

Single-ended input  
SA-200 series

Differential input  
SA-400 series

### Current Amplifier SA-600 series

High gain (1T V/A max.),  
Wide bandwidth

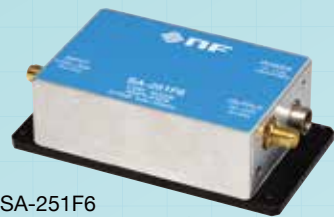

SA-251F6  
Low noise 0.25nV/√Hz



SA-440F5  
High impedance, FET input



### SAMPLES Detects even extremely small signals

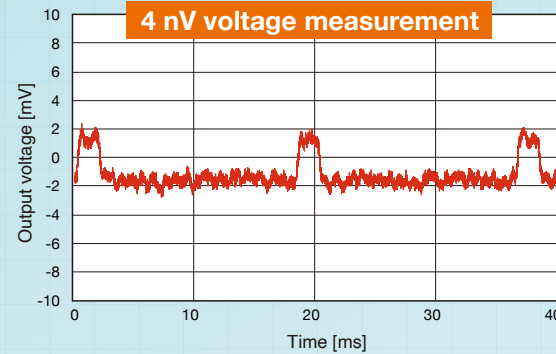

Measured by voltage amplifier SA-410F3

\* The waveform detected by 3 amplifiers connected in series, and averaged. (10k times)

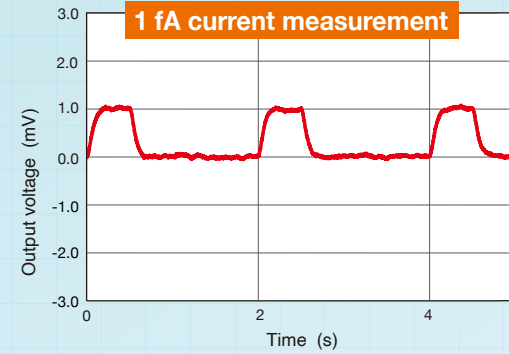

Measured by current amplifier SA-609F2

\* The averaged waveform. (1k times)

## Lineup

### Voltage Amplifier

Voltage Amplifier	Frequency	Input form	Input impedance	Equivalent input noise voltage density*
SA-200F3	DC to 800 kHz	Single-ended, Bipolar	1 k / 10 k / 100 kΩ	0.5 nV / √Hz
SA-220F5	1 kHz to 80 MHz	Single-ended, FET	1 MΩ	0.5 nV / √Hz
SA-240F5	DC to 20 MHz	Single-ended, FET	1 M / 100 MΩ / open	1.2 nV / √Hz
SA-230F5	1 kHz to 100 MHz	Single-ended, Bipolar	50 Ω	0.25 nV / √Hz
SA-250F6	100 Hz to 250 MHz	Single-ended, Bipolar	50 Ω	0.25 nV / √Hz
SA-251F6	1 kHz to 500 MHz	Single-ended, Bipolar	50 Ω	0.25 nV / √Hz
SA-410F3	DC to 1 MHz	Differential, Bipolar	1 k / 10 k / 100 kΩ	0.75 nV / √Hz
SA-420F5	1 kHz to 70 MHz	Differential, FET	1 MΩ	0.9 nV / √Hz
SA-421F5	30 Hz to 30 MHz	Differential, FET	1 MΩ	0.5 nV / √Hz
SA-440F5	DC to 20 MHz	Differential, FET	1 M / 100 MΩ / open	1.8 nV / √Hz
SA-430F5	1 kHz to 100 MHz	Differential, Bipolar	50 Ω	0.35 nV / √Hz

### Current Amplifier

Voltage Amplifier	Frequency	Gain(V/A)	Equivalent input noise current density*
SA-604F2	DC to 500 kHz	10 M	45 fA / √Hz
SA-605F2	DC to 250 kHz	100 M	15 fA / √Hz
SA-606F2	DC to 100 kHz	1 G	6 fA / √Hz
SA-607F2	DC to 20 kHz	10 G	2.5 fA / √Hz
SA-608F2	DC to 2 kHz	100 G	0.6 fA / √Hz
SA-609F2	DC to 300 Hz	1 T	0.4 fA / √Hz

Voltage Amplifier	Frequency	Gain	Equivalent input noise current density*
IV-202F4	DC to 10 MHz	100k V/A	450 fA / √Hz
IV-204F3	DC to 1 MHz	4M V/A	70 fA / √Hz

\* typical

## Best Selection Chart

Select the optimum model according to the signal of the sensor.

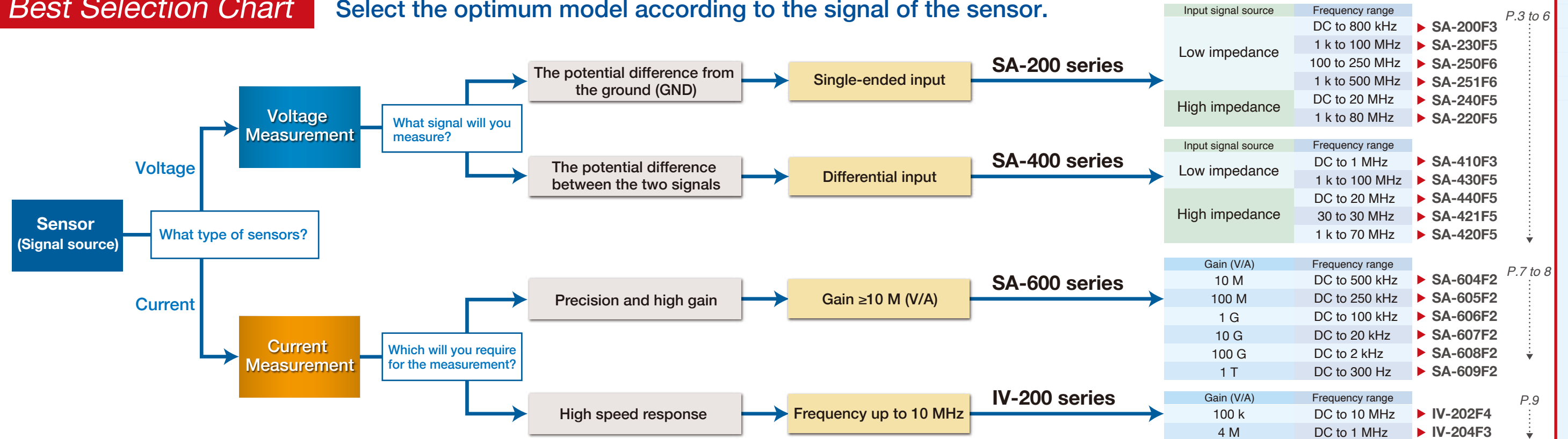

# Low Noise Voltage Amplifier SA-200 series / SA-400 series

Our SA-200 series / SA-400 series preamplifiers detect sub micro-Volt signals and achieve ultra low noise levels previously not possible. Eleven models are available to match differing requirements for frequency range, input form, and input impedance. SA series amplifiers are suitable as head amplifiers for sensors of various types, and they are ideal for enhancing sensitivity of analyzers or measuring instruments.



Voltage Amplifier	Frequency	Input form	Input impedance	Equivalent input noise voltage density <sup>*2</sup>	Gain
SA-200F3	DC to 800 kHz	Single-ended, Bipolar	1 k / 10 k / 100 kΩ	0.5 nV / √Hz	40 dB
SA-220F5	1 kHz to 80 MHz <sup>*1</sup>	Single-ended, FET	1 MΩ	0.5 nV / √Hz	46 dB
SA-240F5	DC to 20 MHz <sup>*1</sup>	Single-ended, FET	1 M / 100 MΩ / open	1.2 nV / √Hz	40 dB
SA-230F5	1 kHz to 100 MHz <sup>*1</sup>	Single-ended, Bipolar	50 Ω	0.25 nV / √Hz	46 dB
<b>New</b> SA-250F6	100 Hz to 250 MHz <sup>*1</sup>	Single-ended, Bipolar	50 Ω	0.25 nV / √Hz	40 dB
<b>New</b> SA-251F6	1 kHz to 500 MHz <sup>*1</sup>	Single-ended, Bipolar	50 Ω	0.25 nV / √Hz	40 dB
SA-410F3	DC to 1 MHz	Differential, Bipolar	1 k / 10 k / 100 kΩ	0.75 nV / √Hz	40 dB
SA-420F5	1 kHz to 70 MHz <sup>*1</sup>	Differential, FET	1 MΩ	0.9 nV / √Hz	46 dB
SA-421F5	30 Hz to 30 MHz	Differential, FET	1 MΩ	0.5 nV / √Hz	46 dB
SA-440F5	DC to 20 MHz	Differential, FET	1 M / 100 MΩ / open	1.8 nV / √Hz	40 dB
SA-430F5	1 kHz to 100 MHz	Differential, Bipolar	50 Ω	0.35 nV / √Hz	46 dB

\*1 Customization for high frequency measurement is available (see P.4) \*2 typical

**Low Noise** | Adoption of our proprietary circuit applying negative feedback technology. Input equivalent noise voltage 0.25 nV / √Hz, noise figure 0.6 dB (input impedance 50 Ω) <SA-250F6>

**Wideband** | From low-frequency including DC to high-frequency / high-speed signal of 500 MHz, covering a wide frequency range.

**High Stability** | High stability against changes in temperature and power supply voltage (SA-250F6/SA-251F6)

**Input form matched to the signal source** | Single-ended input : Bipolar input, FET input  
Differential : Bipolar input, FET input

Fig. 1 and Fig. 2 show comparing the noise characteristic versus signal source resistance (sensor output resistance) for bipolar input model and FET input model. For low signal source resistances, the bipolar input has a better noise characteristic. On the other hand, the FET input's characteristic is stable over a wide range, regardless of the signal source resistance. Choose the model that best suits the signal source.

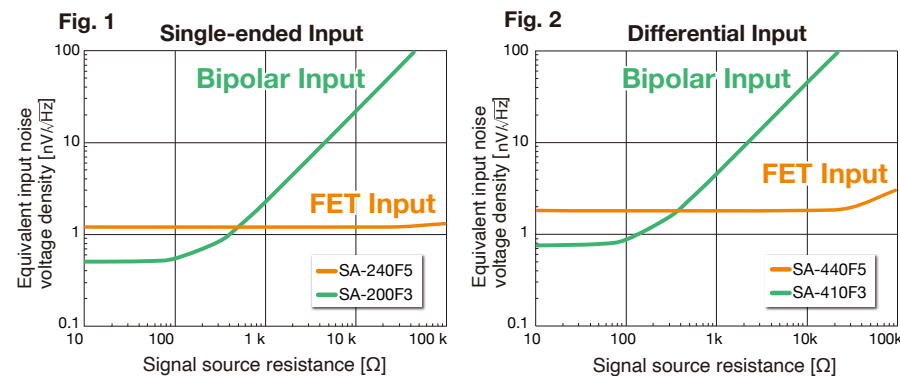

## CHARACTERISTICS

### Equivalent input noise voltage density

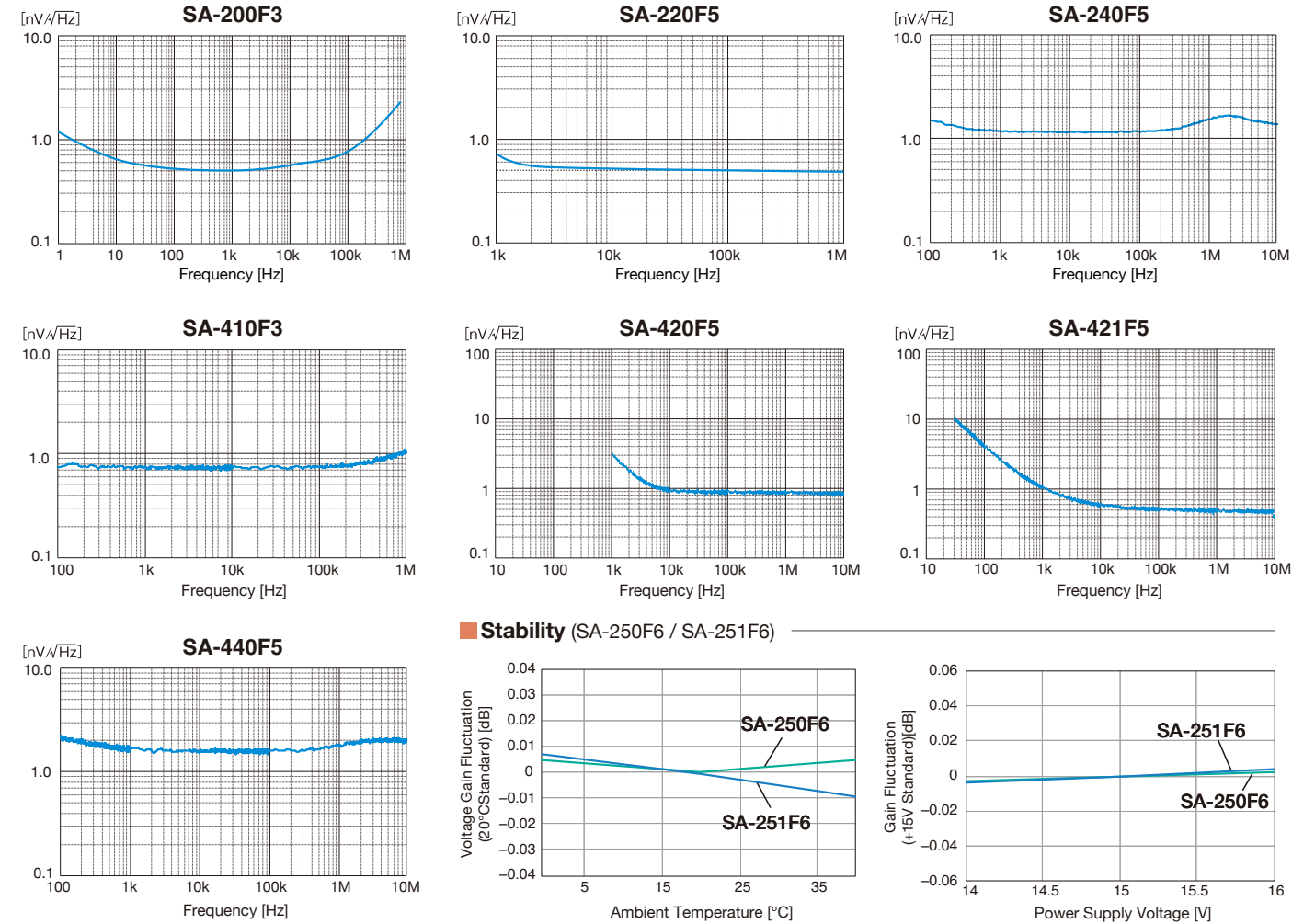

### Noise figure

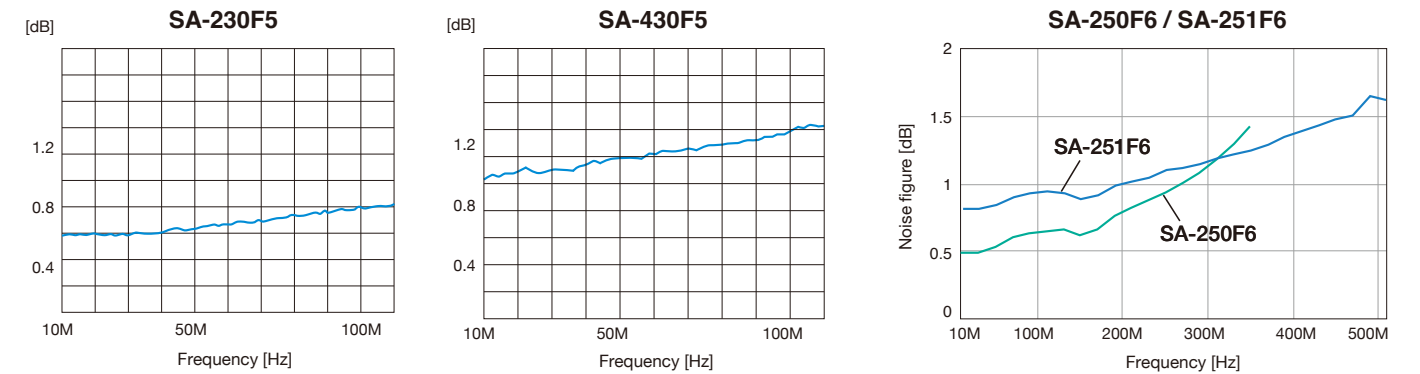

## Applications

- Electromagnetic sensor for MRI/NMR systems
- High precision strain gauge sensor
- High-temperature superconducting Josephson device for microwave detection
- High speed temperature sensor
- Superconducting SQUID sensor for micro-magnetic detection
- Superconducting device in quantum computers

## Custom

Customization is available upon request.

- Change frequency response – expansion of low and high frequency –

Example: in the high frequency range

SA-220F5	1 kHz to 80 MHz	→ 1 kHz to 130 MHz
SA-420F5	1 kHz to 70 MHz	→ 1 kHz to 110 MHz
SA-240F5	DC to 20 MHz	→ DC to 40 MHz

- Overload recovery modification (for MRI/NMR)  
Example: SA-251F6 : 8 ms → 3 μs
- Gain change according to the system (for example, from 46 dB to 40 dB)
- Multichannel



## SA-200 Series Specifications

### Single-ended Input

		DC to 800 kHz SA-200F3 LOW NOISE AMPLIFIER	1 kHz to 80 MHz SA-220F5 LOW NOISE FET AMPLIFIER
INPUT SECTION	Input form	DC coupling, unbalanced single-ended input, SMA	AC coupling, unbalanced single-ended input, SMA
	Input impedance	1 k / 10 k / 100 kΩ ±5 % (DC) // 150 pF or less	1 MΩ ±5 % (5 kHz) // 57 pF typ.
	Maximum input voltage (Non-destructive)	±0.5 V	±1.0 V
	Equivalent input noise voltage density (Input terminal short circuit)	0.7 nV/√Hz or less (1 kHz) 0.5 nV/√Hz typ. (1 kHz)	0.7 nV/√Hz or less (100 kHz) 0.5 nV/√Hz typ. (10 kHz to 1 MHz)
	Equivalent input noise current density	2.2 pA/√Hz typ. (10 kHz)	200 fA/√Hz typ. (100 kHz)
	Noise figure (50 Ω system)	—	—
OUTPUT SECTION	Output form	DC coupling, unbalanced single-ended output, SMA	AC coupling, unbalanced single-ended output, SMA
	Maximum output voltage	±10 V, 1 kΩ (1 kHz)	2.0 Vp-p, 50 Ω (1 kHz to 20 MHz)
	Output impedance	50 Ω ±5 % (DC)	50 Ω ±5 % (100 kHz)
AMPLIFIER SECTION	Voltage gain	40±0.5 dB, 1 MΩ (1 kHz)	46 ±0.5 dB, 50 Ω (1 MHz)
	Voltage gain frequency characteristic	DC to 800 kHz : +0.5 dB, -3 dB typ.	1 kHz to 80 MHz : +0.5 dB, -3 dB
	Total harmonic distortion	0.009 % typ. (1 kHz, ±10 V)	—
	Intercept point	—	—
GENERAL	Power input	Through feed-through capacitor	Through feed-through capacitor
	Operating supply voltage range	±15 V ±5 %	±15 V ±5%
	Consumption current (no signal)	±50 mA or less	+65 mA typ. +75 mA or less -10 mA typ. -15 mA or less
	Operating temperature ranges	0°C to 40°C	0°C to 40°C
	Storage temperature and humidity ranges (non-condensation)	-10°C to 50°C 10 % RH to 80 % RH	-10°C to 50°C 10 % RH to 80 % RH
	Dimensions (without protrusions and bottom plate)	68(W)×43(D)×17.6(H) mm	68(W)×43(D)×28(H) mm
	Weight	Approx. 90 g	Approx. 130 g
	Accessories	Instruction manual, bottom plate	

If not specified, Supply voltage ±15 V (SA-230F5: +15 V), temperature 23°C ±5°C

● Recommended power supply: Low Noise DC Power Supply LP series  
Use a dedicated cable for power supply from LP series. See back cover.

## SA-400 Series Specifications

### Differential Input

		DC to 1 MHz SA-410F3 LOW NOISE DIFFERENTIAL AMPLIFIER	1 kHz to 70 MHz SA-420F5 LOW NOISE DIFFERENTIAL FET AMPLIFIER
INPUT SECTION	Input form	DC coupling, balanced differential input, SMA	AC coupling, balanced differential input, SMA
	Input impedance	1 k/10 k/100 kΩ ±5 % // 100 pF typ.	1 MΩ ±5 % (1 kHz) // 15 pF typ.
	Maximum input voltage (Non-destructive)	Differential input : ±1 V Common-mode input : ±15 V	Differential input : ±10 V DC or 4 Vp-p AC Common-mode input : ±10 V DC or 6 Vp-p AC
	CMRR (Equivalent input)	110 dB or more (55 Hz) 80 dB typ. (100 kHz)	55 dB or more (1 kHz to 10 MHz)
	Equivalent input noise voltage density (Input terminal short circuit)	0.75 nV/√Hz typ. (1 kHz)	1.2 nV/√Hz or less (100 kHz) 0.9 nV/√Hz typ. (100 kHz to 10 MHz)
	Equivalent input noise current density	4.5 pA/√Hz typ. (10 kHz)	100 fA/√Hz typ. (1 kHz)
OUTPUT SECTION	Output form	DC coupling, unbalanced single-ended output, SMA	AC coupling, unbalanced single-ended output, SMA
	Maximum output voltage	±10 V, 1 kΩ (1 kHz)	2.0 Vp-p, 50 Ω (1 kHz to 20 MHz)
	Output impedance	50 Ω ±5 % (100 Hz)	50 Ω ±5 % (100 kHz)
AMPLIFIER SECTION	Voltage gain	40 ±0.2 dB, 1 MΩ (1 kHz)	46 ±0.5 dB, 50 Ω (1 MHz)
	Voltage gain frequency characteristic	DC to 1 MHz : +0.5 dB, -3 dB	1 kHz to 70 MHz : +0.5 dB, -3 dB
	Total harmonic distortion	0.004 % typ. (1 kHz, ±10 V)	—
	Intercept point	—	—
GENERAL	Power input	HR10-7R-4P(73) (Hirose Electric)	Through feed-through capacitor
	Operating supply voltage range	±15 V ±1 V	±15 V ±5 %
	Consumption current (no signal)	±45 mA typ. ±75 mA or less (Max. output, load: 1 kΩ)	+54 mA typ. +70 mA or less -25 mA typ. -40 mA or less
	Operating temperature ranges	0 °C to 40 °C	+5 °C to +35 °C
	Storage temperature and humidity ranges (non-condensation)	-10 °C to 50 °C 5 % RH to 95 % RH	-10 °C to 50 °C 5 % RH to 95 % RH
	Dimensions (without protrusions and bottom plate)	76(W)×50(D)×21.1(H) mm	68(W)×43(D)×28(H) mm
	Weight	Approx. 105 g	Approx. 100 g
	Accessories	Instruction manual, bottom plate, SMA shorting plug	

If not specified, Supply voltage ±15 V, temperature 23°C ±5°C

● Recommended power supply: Low Noise DC Power Supply LP series  
Use a dedicated cable for power supply from LP series. See back cover.

		DC to 20 MHz SA-240F5 LOW NOISE FET AMPLIFIER	DC to 20 MHz SA-230F5 LOW NOISE AMPLIFIER	100 Hz to 250 MHz SA-250F6 LOW NOISE AMPLIFIER	1 kHz to 500 MHz SA-251F6 LOW NOISE AMPLIFIER
INPUT SECTION	Input form	DC coupling, unbalanced single-ended input, SMA	AC coupling, unbalanced single-ended input, SMA	AC coupling, unbalanced single-ended input, SMA	AC coupling, unbalanced single-ended input, SMA
	Input impedance	1 MΩ / 100 MΩ / open // 60 pF typ.	50 Ω ±5 % (100 kHz)	50 Ω (1 MHz)	50 Ω (1 MHz)
	Maximum input voltage	±1.0 V	±1.0 V	±0.7 V	±0.7 V
	Equivalent input noise voltage density (1 kHz)	1.2 nV/√Hz (1 kHz)	0.35 nV/√Hz or less (100 kHz) 0.25 nV/√Hz typ. (10 kHz to 1 MHz)	0.25 nV/√Hz or less (1 MHz)	0.25 nV/√Hz or less (1 MHz)
	Equivalent input noise current density (100 Hz)	5 fA/√Hz (100 Hz)	5.0 pA/√Hz typ. (100 kHz)	5 pA/√Hz typ. (1 MHz)	8 pA/√Hz typ. (1 MHz)
	Noise figure (100 MHz)	—	0.7 dB or less, 0.6 dB typ. (10 MHz) 1.0 dB or less, 0.8 dB typ. (100 MHz)	0.6 dB (10 MHz) 1.0 dB (250 MHz)	0.9 dB (10 MHz) 1.2 dB (250 MHz) 1.8 dB (500 MHz)
OUTPUT SECTION	Output form	DC coupling, unbalanced single-ended output, SMA	AC coupling, unbalanced single-ended output, SMA	AC coupling, unbalanced single-ended output, SMA	AC coupling, unbalanced single-ended output, SMA
	Maximum output voltage	±10 V, 1 kΩ	1.8 Vp-p, 50 Ω (1 kHz to 20 MHz)	2.0 Vp-p	2.0 Vp-p
	Output impedance	50 Ω (1 kHz)	50 Ω ±5 % (100 kHz)	50 Ω (1 MHz)	50 Ω (1 MHz)
AMPLIFIER SECTION	Voltage gain	40 dB ±0.1 dB or less (1 kHz)	46 ±0.5 dB, 50 Ω (20 MHz)	40 ±0.5 dB (1 MHz)	40 ±0.5 dB (1 MHz)
	Voltage gain frequency characteristic	DC to 20 MHz : +0.5 dB, -3 dB	1 kHz to 100 MHz : +0.5 dB, -3 dB	100 Hz to 250 MHz (1 MHz Standard)	1 kHz to 500 MHz (1 MHz Standard)
	Total harmonic distortion	0.004 % (2 Vp-p)	—	—	—
	Intercept point	—	+30 dBm typ. (68 MHz)	—	—
GENERAL	Power input	HR10-7R-4P (73) (Hirose Electric)	Through feed-through capacitor	HR10-7R-4P(73) (Hirose Electric)	HR10-7R-4P(73) (Hirose Electric)
	Operating supply voltage range	±15 V ±1 V	±15 V ±5 %	±15 V ±1 V or less	±15 V ±1 V or less
	Consumption current (no signal)	±45 mA ±75 mA or less (Max.)	+55 mA or less	+50 mA +65 mA or less	+65 mA +85 mA or less
	Operating temperature ranges	0°C to 40°C	0°C to 40°C	0°C to 40°C	0°C to 40°C
	Storage temperature and humidity ranges (non-condensation)	-10°C to 50°C 5 % RH to 95 % RH	-10°C to 50°C 10 % RH to 80 % RH	-10°C to 50°C 5 % RH to 95 % RH	-10°C to 50°C 5 % RH to 95 % RH
	Dimensions (without protrusions and bottom plate)	76(W)×50(D)×25(H) mm	68(W)×43(D)×17.6(H) mm	76(W)×50(D)×25(H) mm	76(W)×50(D)×25(H) mm
	Weight	Approx. 105 g	Approx. 90 g	Approx. 140 g	Approx. 140 g
	Accessories	Instruction manual, bottom plate			

		30 Hz to 30 MHz SA-421F5 LOW NOISE DIFFERENTIAL FET AMPLIFIER	DC to 20 MHz SA-440F5 LOW NOISE DIFFERENTIAL FET AMPLIFIER	1 kHz to 100 MHz SA-430F5 LOW NOISE DIFFERENTIAL AMPLIFIER
INPUT SECTION	Input form	AC coupling, balanced differential input, SMA	DC coupling, balanced differential input, SMA	AC coupling, balanced differential input, SMA
	Input impedance	1 MΩ ±5 % (1 kHz) // 85 pF typ.	1 MΩ / 100 MΩ / open // 60 pF typ.	50 Ω ±5 % (100 kHz)
	Maximum input voltage (Non-destructive)	Differential input : ±10 V DC or 4 Vp-p AC Common-mode input : ±10 V DC or 6 Vp-p AC	Differential input : ±1 V Common mode input : ±7.5 V	±2.0 V (Differential / Common-mode input)
	CMRR (Equivalent input)	46 dB or more (1 kHz to 10 MHz)	90 dB (10 Hz to 10 kHz) ,60 dB (1 MHz)	80 dB or more (100 kHz), 90 dB typ. (100 kHz) 80 dB typ. (10 MHz)
	Equivalent input noise voltage density (Input terminal short circuit)	0.7 nV/√Hz or less (100 kHz) 0.5 nV/√Hz typ. (100 kHz to 10 MHz)	1.8 nV/√Hz (1 kHz)	0.45 nV/√Hz or less (100 kHz) 0.35 nV/√Hz typ. (10 kHz to 1 MHz)
	Equivalent input noise current density	100 fA/√Hz typ. (100 Hz)	25 fA/√Hz (100 Hz)	7.0 pA/√Hz typ. (100 kHz)
OUTPUT SECTION	Output form	AC coupling, unbalanced single-ended output, SMA	DC coupling, unbalanced single-ended output, SMA	AC coupling, unbalanced single-ended output, SMA
	Maximum output voltage	2.0 Vp-p, 50 Ω (100 Hz to 20 MHz)	±10 V, 1 kΩ	2.0 Vp-p, 50 Ω (1 kHz to 20 MHz)
	Output impedance	50 Ω ±5 % (100 kHz)	50 Ω (1 kHz)	50 Ω ±5 % (100 kHz)
AMPLIFIER SECTION	Voltage gain	46 ±0.5 dB, 50 Ω (1 MHz)	40 dB ±0.1 dB or less (1 kHz)	1 kHz to 100 MHz : +0.5 dB, -3 dB
	Voltage gain frequency characteristic	30 Hz to 30 MHz : +0.5 dB, -3 dB	DC to 20 MHz : +0.5 dB, -3 dB	—
	Total harmonic distortion	—	0.006 % (2Vp-p)	+28 dBm typ. (68 MHz)
	Intercept point	—	—	Through feed-through capacitor
GENERAL	Power input	Through feed-through capacitor	HR10-7R-4P (73) (Hirose Electric)	±15 V ±5 %
	Operating supply voltage range	±15 V ±5 %	±15 V ±1 V	+55 mA typ. +65 mA or less
	Consumption current (no signal)	+74 mA typ. +90 mA or less -64 mA typ. -80 mA or less	±55 mA ±75 mA or less (Max.)	-30 mA typ. -45 mA or less
	Operating temperature ranges	+5 °C to +35 °C	0 °C to 40 °C	0 °C to +40 °C
	Storage temperature and humidity ranges (non-condensation)	-10 °C to 50 °C 5 % RH to 95 % RH	-10 °C to 50 °C 5 % RH to 95 % RH	-10 °C to 50 °C 10 % RH to 80 % RH
	Dimensions (without protrusions and bottom plate)	68(W)×43(D)×28(H) mm	76(W)×50(D)×25(H) mm	68(W)×43(D)×28(H) mm
	Weight	Approx. 100 g	Approx. 120 g	Approx. 130 g
	Accessories	Instruction manual, bottom plate, SMA shorting plug		

If not specified, Supply voltage ±15 V, temperature 23°C ±5°C

● Recommended power supply: Low Noise DC Power Supply LP series  
Use a dedicated cable for power supply from LP series. See back cover.

# Wideband Current Amplifier

SA-600 series

SA-600 series preamplifiers for detection of sub nano-Amp. signals achieve high gain and wide bandwidth that were previously not possible. Six models are available to match differing requirements for gain and frequency range.

SA-600 series amplifiers are suitable as head amplifiers for current output sensors, and they are ideal for enhancing sensitivity of analyzers or measuring instruments.



Current Amplifier	Gain (V/A)	Frequency	Equivalent input current noise density*
SA-604F2	10 M	DC to 500 kHz	45 fA / $\sqrt{\text{Hz}}$
SA-605F2	100 M	DC to 250 kHz	15 fA / $\sqrt{\text{Hz}}$
SA-606F2	1 G	DC to 100 kHz	6 fA / $\sqrt{\text{Hz}}$
SA-607F2	10 G	DC to 20 kHz	2.5 fA / $\sqrt{\text{Hz}}$
SA-608F2	100 G	DC to 2 kHz	0.6 fA / $\sqrt{\text{Hz}}$
SA-609F2	1 T	DC to 300 Hz	0.4 fA / $\sqrt{\text{Hz}}$

\* typical

## Both high gain and wideband have been achieved up to 1 T (V/A)

Six models are available with gains of 10 M / 100 M / 1 G / 10 G / 100 G / 1 T (V / A).

## Stable with capacitance of sensor and connection cable.

SA-600 series operates stably against input capacitance such as parallel capacitance of sensors and connection cables. The overshoot and the ringing rarely occur for pulse response.

### Using NF's Wideband Current Amplifier

At the conventional current amplifiers, big overshoot or ringing occurs on pulse response by additional input capacitance (see the upper right graph).

In this case, by adding feedback capacitors, overshoots can be reduced, but rise time increases significantly. The conventional current amplifiers are used with sensors of fixed input capacitance. It means standardization of the current amplifier is difficult. SA-600 series operates stably with capacitance of the input side, and realizes 10 times higher speed responses than the previous model.

Pulse response characteristics

Conventional current amplifier  
Gain: 1 G (V/A)

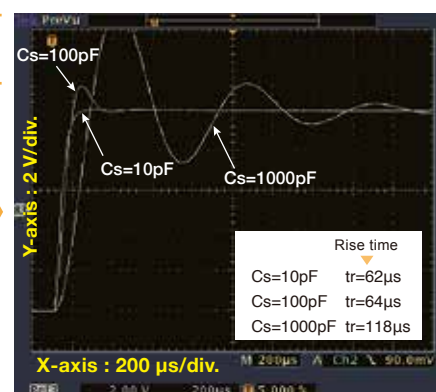

SA-606F2  
Gain: 1 G (V/A)

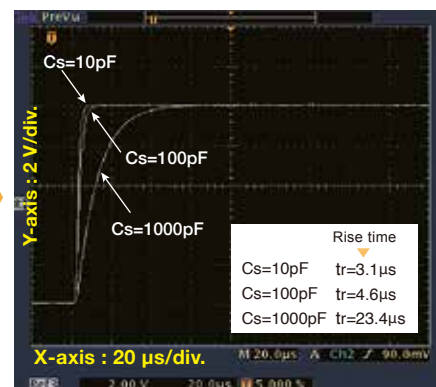

\*Cs: capacitance between input and GND

## Low Noise

SA-600 series achieves a low noise of fA/ $\sqrt{\text{Hz}}$  (10<sup>-15</sup>) order, which adopts SMA connectors with excellent shielding effectiveness.

## LPF Output

The SA is equipped with a low pass filter to reduce high frequency noise.

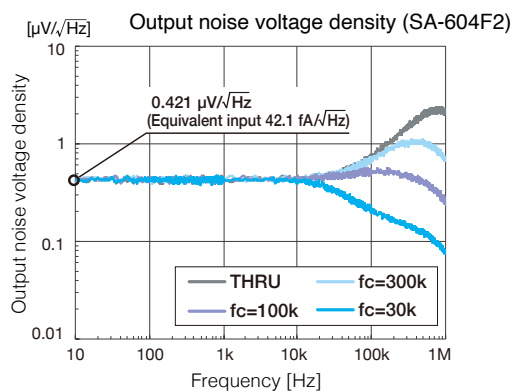

## Applications

- Signal amplification of current-output sensors: Faraday cups, photodiodes, magnetic sensors, radiation sensors
- Built-in amplifier for TEM/SEM/STI/AFM
- Signal amplification for semiconductor inspection
- Beam monitor of the particle accelerator
- Ionization detector
- External preamplifier of lock-in amplifier

## CHARACTERISTICS

### Gain-Frequency

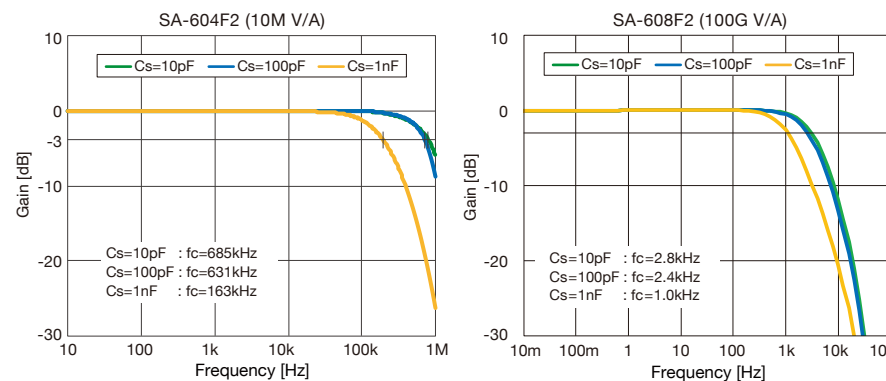

### Equivalent input noise voltage density

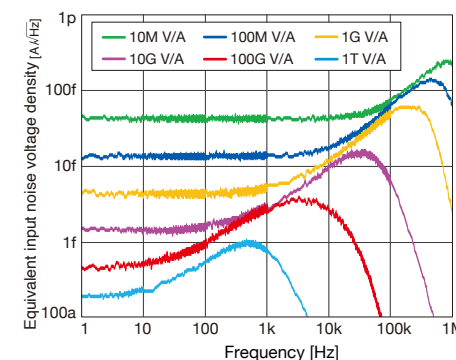

## Specifications

Specifications	SA-604F2	SA-605F2	SA-606F2	SA-607F2	SA-608F2	SA-609F2		
INPUT SECTION	Input form	DC coupling, unbalanced single-ended input, SMA connector						
	Maximum input current	±1 μA	±100 nA	±10 nA	±1 nA	±100 pA	±10 pA	
	Input impedance	1 kΩ (typ.)	3 kΩ (typ.)	10 kΩ (typ.)	30 kΩ (typ.)	100 kΩ (typ.)	600 kΩ (typ.)	
	Recommended signal source resistance	1 MΩ or more	10 MΩ or more	100 MΩ or more	1 GΩ or more	10 GΩ or more	100 GΩ or more	
	Input bias current	±1 pA (typ.)			0.1 pA (typ.)		10 fA (typ.)	
	Equivalent input current noise density *1	45 fA/√Hz (typ.)	15 fA/√Hz (typ.)	6 fA/√Hz (typ.)	2.5 fA/√Hz (typ.)	0.6 fA/√Hz (typ.)	0.4 fA/√Hz (typ.)	
OUTPUT SECTION	Output form	DC coupling, unbalanced single-ended input, SMA connector						
	Maximum output voltage	±10 V						
	Maximum output current	±5 mA						
	Output impedance	50 Ω						
	Output offset voltage	±3 mV	±5 mV		±15 mV	±30 mV		
AMPLIFIER SECTION	Gain	1×10 <sup>7</sup> (10 M) V/A ±1%	1×10 <sup>8</sup> (100 M) V/A ±1%	1×10 <sup>9</sup> (1 G) V/A ±1%	1×10 <sup>10</sup> (10 G) V/A ±1%	1×10 <sup>11</sup> (100 G) ±3%	within 1×10 <sup>12</sup> (1 T) ±1%	
	Gain flatness (within ±0.5 dB)*2	DC to 50 kHz	DC to 25 kHz	DC to 10 kHz	DC to 2 kHz	DC to 200 Hz	DC to 30 Hz	
	Frequency response (Cs=10 pF)*2,3	DC to 500 kHz	DC to 250 kHz	DC to 100 kHz	DC to 20 kHz	DC to 2 kHz	DC to 300 Hz	
	I/O polarity	Non-inverting						
	LPF (Cut-off frequency setting, selectable with a switch)	30 kHz / 100 kHz / 300 kHz / THRU	10 kHz / 30 kHz / 100 kHz / THRU	3 kHz / 10 kHz / 30 kHz / THRU	1 kHz / 3 kHz / 10 kHz / THRU	100 Hz / 300 Hz / 1 kHz / THRU	30 Hz / 3 Hz / 0.3 Hz / THRU	
	Power input	HR10-7R-4P (73) connector (Hirose Electric)						
	Operating power supply voltage	±15 V ±1 V						
GENERAL	Current consumption (no signal)	±40 mA or less			±40 mA or less		±40 mA or less	
	Performance guarantee temperature range	23°C ±5°C						
	Temperature and Humidity range	Operation	0°C to 40°C, 5% to 85% RH				0°C to 40°C, 5% to 75% RH	
		Storage	-10°C to 50°C, 5% to 95% RH				-10°C to 50°C, 5% to 75% RH	
	Dimensions (mm)	76(W)×50(D)×21.1(H)					100(W)×50(D)×25(H)	
Weight (approx.)	135 g					140 g		
RoHS	Directive 2011/65/EU							
EMC	EN 61326-1: 2013							
Accessories	Instruction manual, bottom plate, SMA open plug, BNC to SMA adapter ×2							

\*1 when f = 1 kHz, when f = 100 Hz for SA-607F2, when f = 10 Hz for SA-608F2 and SA-609F2. \*2 When the cut-off frequency is set at THRU. \*3 "Cs" is an added input capacitance between input and GND.

### Dimensions

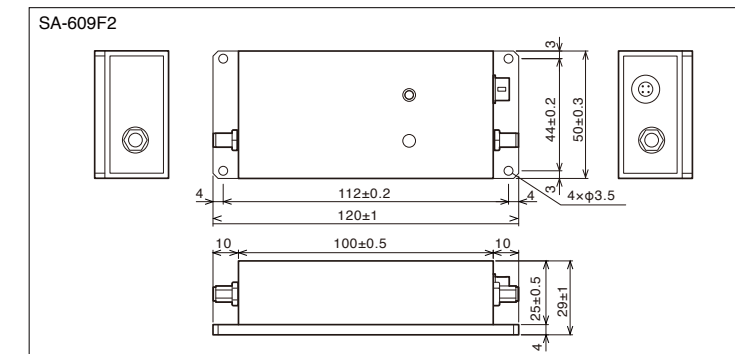
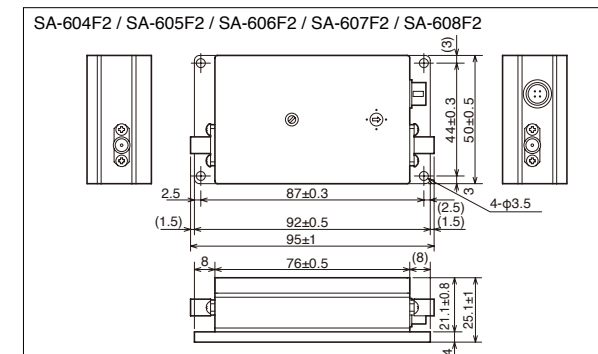





The IV-200 series is a compact current to voltage converter. It realizes wide bandwidth and low noise characteristics.

Characteristics

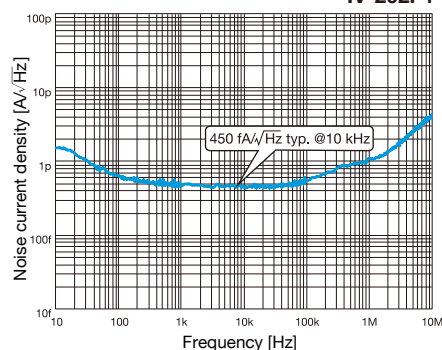

Specifications

	DC to 10 MHz IV-202F4	DC to 1 MHz IV-204F3	
INPUT SECTION	Input form	DC coupling, unbalanced single ended input, SMB (male)	
	Maximum input current	±100 μA	±2.5 μA
	Input impedance	30 Ω or less	1.2 kΩ or less
	Recommended signal source impedance	25 kΩ or more, 20 pF or less	1 MΩ or more, 50 pF or less
	Input bias current	5 pA typ.	
	Equivalent input noise current density	600 fA/√Hz or less 450 fA/√Hz typ. (10 kHz, input opened)	90 fA/√Hz or less 70 fA/√Hz typ. (1 kHz, input opened)
OUTPUT SECTION	Output form	DC coupling, unbalanced single ended output, SMB connector (male)	
	Phase between input and output	Inverting	
	Maximum output voltage	±10 V	
	Maximum output current	±5 mA	
	Output impedance	50 Ω ±10 %	
AMPLIFIER SECTION	Gain	1×10 <sup>5</sup> V/A ±5 %	4×10 <sup>6</sup> V/A ±5 %
	Frequency bandwidth	DC to 10 MHz (Based on 10 kHz, +1 to -3 dB)	DC to 1 MHz (Based on 10 kHz, +1 to -3 dB)
GENERAL	Power input	DF11-4DP-2DS(52) (4 pins, male) Hirose Electric	
	Operating supply voltage range	±15 V ±1 V	
	Consumption current	±40 mA or less, ±25 mA typ. (no signal)	
	Adjuster for frequency response	Adjustable frequency response, If large input parallel capacitance is connected.	
	Performance guarantee temperature range	23°C ±5°C	
	Temperature and humidity ranges	Operating: 0°C to 40°C, 10 % RH to 90 % RH Storage: -10°C to 60°C, 10% RH to 80% RH	
	External dimensions / Weight	80(W)×15(D)×21(H) mm (without protrusions) / Approx. 25 g	
	RoHS	Directive 2011/65/EU	
	Accessories	Instruction manual, Power supply cable (DF11-4DS-2C connector (4 pins, female), Hirose Electric)	

For measuring small AC signals on the order of μV superimposed on DC signals.



Single-ended input

- Applicable up to ± 40 VDC
- Low noise : 2 nV / √Hz(1 kHz)
- High gain and wide bandwidth : 60 dB, 0.1 Hz to 3 MHz
- LPF : 3 Hz, 10 Hz, 100 Hz, 1 kHz, 10 kHz, 100 kHz, 1 MHz, THRU

▶▶ Differential input model is available. Contact us for further details.

Output noise waveform of DC power supply (output 15 V)

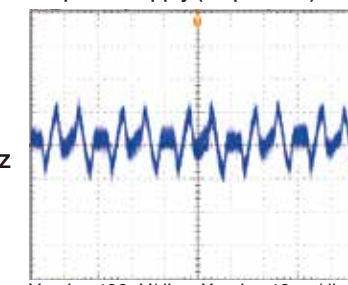

Y-axis : 100μV/div. X-axis : 10ms/div.

LP series enable the optimal performance of SA series amplifiers

Low Noise DC Power Supply

LP series

Highly stable DC power supply with extremely low output noise voltage, thorough noise resistance, and ultra low noise design. The SA series meets severe low noise demands when used in conjunction with an LP power supply.

LP5394

The output noise voltage is at most 10 μVrms. This represents the highest standard of low-noise DC power supplies, yet we are able to offer the LP series at reasonable prices. Additionally, we have incorporated low-noise and highly stable reference voltage sources to achieve a level of temperature stability higher than conventional DC power supplies by a factor of 5 to 10. Our power supplies have the capability to provide stable and reliable power for extended periods of time.

- Low Noise : Output Noise:10 μVrms or lower (typ.) 10 Hz to 20 MHz bandwidth
- Low Drift : Output Voltage Stability: ±10 ppm/°C (typ.)
- Output Voltage : 0 to ±15 V
- Output Current : 0.1 A max.
- Precisely adjusts the output voltage using the 10-turn potentiometer
- 1/4-rack sized for easy integration into multi-channel rack



LP5393

With an output noise voltage of 10 μVrms at most, the LP5393 DC power supply maximizes the performance capabilities of our SA series of low noise amplifiers.

- Output Noise : 10 μVrms or lower (typ.) 10 Hz to 20 MHz bandwidth
- Output Voltage Stability : ±20 ppm/°C (typ.)
- Output Voltage : ±12 V to ±15 V
- Output Current : 0.1 A max.
- 1/4-rack size



Multichannel Low Noise Amplification System

Sensors, from low resistance to high resistance — Highly accurate signal processing



For Multichannel Needs

- Low Noise 1.3 nV/√Hz (Bipolar Input), 2.5 nV/√Hz (FET Input)
- Compact and Optimized for Multichannel Needs
- Multifunction

Achieved only by switch control (no need to add components)

- Input-coupling : DC / AC
- Input-mode : differential / single-ended / GND
- LPF : THRU (OFF) / LPF (ON)
- Equivalent input offset voltage: adjustment range ±100μV
- Amplifier GND : FLOAT / EXTERNAL

We propose the optimal system according to the requirements

- Multi-channeling to suit the application
- Single-ended input

For signals requiring even lower noise, a single-ended input dedicated model (0.8 nV/√Hz) is also available.

The world's Leading Low Noise Performance

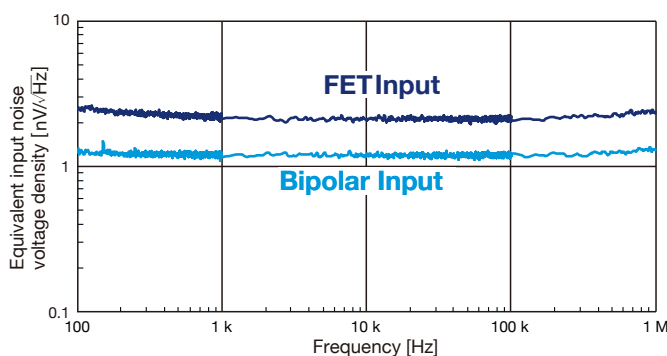

Low Noise DC Voltage Source

LP6016-01 / LP6016-01P

LP6016-01/LP6016-01P is a low voltage DC voltage source equipped with LAN/USB/RS-232 interface. It can be used as a DC bias source for photodiodes and a control voltage source for crystal oscillators.

- Output Noise : 10 μVrms 10 Hz to 20 MHz bandwidth
- Output Voltage Stability : ±10 ppm/°C typ.
- Output Voltage : [LP6016-01] 0 to +16.1 V(+)/ 0 to -16.1 V(-)  
[LP6016-01P] 0 to +16.1 V(2 outputs V1, V2)
- Setting Resolution : 500 μV
- Setting Accuracy : ±(0.03 % + 250 μV)
- Output Current : 0.1 A max.
- Interface : USB, RS-232, LAN

Remote controllable



CE

## Ordering Information

### SA-200 series / SA-400 series

Model	Description
SA-200F3	Low Noise Amplifier
SA-220F5	Low Noise FET Amplifier
SA-240F5	Low Noise FET Amplifier
SA-230F5	Low Noise Amplifier
SA-250F6	Low Noise Amplifier
SA-251F6	Low Noise Amplifier
SA-410F3	Low Noise Differential Amplifier
SA-420F5	Low Noise Differential FET Amplifier
SA-421F5	Low Noise Differential FET Amplifier
SA-440F5	Low Noise Differential FET Amplifier
SA-430F5	Low Noise Differential Amplifier

### IV-200 series

Model	Description
IV-202F4	Transimpedance Amplifier
IV-204F3	Transimpedance Amplifier

### Low Noise DC Power Supply

Model	Description
LP5393	Low Noise DC Power Supply
LP5394	Low Noise DC Power Supply

### Low Noise DC Voltage Source

Model	Description
LP6016-01	Low Noise DC Voltage Source
LP6016-01P	Low Noise DC Voltage Source

### Special Website

Competitive Comparison data showing our low noise performance is available on our website.  
NF also offers custom-designed amplifiers in addition to the line up in this brochure.

### SA-600 series

Model	Description
SA-604F2	Wideband Current Amplifier
SA-605F2	Wideband Current Amplifier
SA-606F2	Wideband Current Amplifier
SA-607F2	Wideband Current Amplifier
SA-608F2	Wideband Current Amplifier
SA-609F2	Wideband Current Amplifier

### Option

PA-001-2985	SMA Shorting Plug (for SA-200 and SA-400 series)
PA-001-2986	SMA to BNC Adapter (for all SA series)
PA-001-3017	SMB to BNC Adapter (for IV-200 series)

### Option (LP5393 / LP5394)

PA-001-2590	BNC Adapter
PA-001-2591	Binding Post Adapter
PA-001-2372	Output Cable A (2m) [ for ●SA-600 series ●SA-410F3 ●SA-240F5 ●SA-250F6 ●SA-251F6 ] [ for ●SA-440F5 ●PA-001-2590 ●PA-001-2591 ]
PA-001-2373	Output Cable B (2m) [ for ●SA-200F3 ●SA-220F5 ●SA-420F5 ●SA-421F5 ●SA-430F5 ]
PA-001-2374	Output Cable C (2m) [ for ●SA-230F5 ]
PA-001-3029	Output Cable D (2m) [ for ●IV-200 series ]
PA-001-2642	Rack Mount Kit (EIA, for 4 units) [ for ●LP5393 ]
PA-001-2643	Rack Mount Kit (JIS, for 4 units) [ for ●LP5394 ]



**PA-001-2590**  
BNC Adapter

Output conversion to BNC connector  
\*Output cable A is required



**PA-001-2591**  
Binding Post Adapter

Output conversion to Binding post  
\*Output cable A is required

\*Note: The contents of this catalog are current as of November 6th, 2024.

Product appearance and specifications are subject to change without notice.

Before purchase, contact us to confirm the latest specifications, price and delivery date.

# NF Corporation

## Head Office

6-3-20 Tsunashima Higashi, Kohoku-ku, Yokohama 223-8508, Japan

Phone : +81-45-545-8128 Fax : +81-45-545-8187

<http://www.nfcorp.co.jp/english/>