



PROGRAMMABLE AC/DC POWER SOURCE

Three-phase System

ES 2000U Three-phase Master
ES 2000P Three-phase Slave
ES 2000B Booster

INSTRUCTION MANUAL

2-STATION ● **ES**

DA00008175-001

P-STATION/ES Series
Programmable AC/DC Power Source
Three-phase System
INSTRUCTION MANUAL

---- Preface ----

Thank you for purchasing our “P-STATION/ES-series Programmable AC/DC Power Source”.

For safe use of these electrical products, read “**Safety Precautions**” on the next page before using them.

■ **Warning symbols appearing in this Instruction Manual**

The warning symbols shown below are used in this manual. Be sure to follow the warnings and cautions indicated by these symbols to ensure users' personal safety and protect against damage to equipment.

WARNING

Together with this symbol, information is provided to prevent users from encountering hazards, such as electric shock, that could result in serious injury or death when they handle the equipment.

CAUTION

Together with this symbol, information is provided in order to prevent damage to equipment when users handle the equipment.

● **The Instruction Manual consists of the chapters outlined below.**

Before using this product for the first time, read this manual, starting with Chapter 1, “Overview.”

1. Overview

The chapter provides confirmation items that must be made before the equipment is used.

2. Part Names

The chapter gives the names and descriptions of parts of the equipment.

3. Grounding and Connections

The chapter provides information you should keep in mind during installation and until equipment is turned on to prepare the equipment for use.

4. Operations

The chapter describes basic operations and advanced functions.

5. Specifications

The chapter contains specifications (on functions and performance).

6. Maintenance

The chapter explains how to perform basic operational tests and describes routine maintenance.

7. Troubleshooting

The chapter explains error messages and the phenomena considered to be failures, and it describes the appropriate action to be taken.

8. Supplementary Information

The chapter contains supplementary information to provide a better understanding of the equipment.

---- Safety Precautions ----

To use the equipment safely, be sure to follow the warnings and cautions given below.

NF Corporation takes no responsibility for and does not warranty against damage that may have occurred as a result of a failure to comply with these warnings and cautions.

This product consists of insulation standard class I devices (with protective conductor terminals) as defined by the JIS and IEC standards.

- **Be sure to follow instructions in the Instruction Manual.**

The Instruction Manual provides users with information on the operation and safe use of this product.

Read the manual before using the product.

All warnings in the manual are provided to prevent hazardous situations possibly leading to serious accidents from occurring. Be sure to follow these warnings.

- **Connect the product to ground.**

The product uses a line filter, which may cause electric shock if the product is not grounded.

To prevent such electric shock, be sure to connect the product securely to ground.

Connect the ground terminal on the rear panel to ground with a cable as thick as or thicker than the power cord.

- **Check the power supply voltage.**

This product operates on the power supply voltage specified in “Grounding and Power Connections.”

Before connecting the product to a power supply, make sure that the power supply voltage conforms to the power supply voltage rating of the product.

When this equipment operates for a long time under a load condition, the exhaust vent on the back of the device becomes hot. Be careful not to touch this part directly.

To reduce the risk of the device being dropped during handling, do not lift it by its handle.

Each device uses dedicated accessories, peripherals, and options. Never use them for a purpose other than the installation and operation of the device.

To prevent electric shock and failures, do not turn on the device when a cord or unit is disconnected. Also, do not remove a unit when power is on.

To prevent electric shock and failures, never allow foreign matter or liquid to enter the device.

To prevent electric shock and failures, turn off the device before attaching a cable to or detaching one from the remote sensing terminal. When the cable is attached to the terminal, make sure that the metal part of the cable is covered.

- **When a problem may have occurred**

If smoke or an abnormal smell or sound is coming from any of the devices, turn off the device immediately and stop device operations.

In such an event, disable operation of the device until it is repaired, and contact our office or agent who sold you the device.

- **Do not use the equipment in an environment where an explosive gas (such as**

propane or kerosene) is present.

There is a danger of explosion.

- **Do not remove the covers.**

The equipment contains high-voltage parts. Never remove the covers.

Even when the inside of one of the devices must be checked, only authorized service engineers should handle the internal parts directly.

- **Do not retrofit the equipment.**

Never retrofit the equipment. Otherwise, new and unforeseeable risks may arise, and NF Corporation may refuse your request for repair.

- **Safety-related symbols**

General definitions of safety-related symbols on the equipment and in the Instruction Manual are given below.



Manual reference

This symbol notifies users of a potential danger, and it appears on parts that require users to refer to the Instruction Manual.



Danger of electric shock

This symbol appears on parts that could cause electric shock under certain conditions.



Protective ground terminal

This symbol appears on terminals that must be grounded to prevent electric shock.

Before using the equipment, be sure to connect such terminals to ground.



Warning

Together with this symbol, information is provided in order to prevent users from encountering hazards, such as electric shock, that could result in serious injury or death.



Caution

Together with this symbol, information is provided in order to prevent damage when users handle the equipment.

- **Other symbols**



This symbol indicates the ON position of a power switch.



This symbol indicates the OFF position of a power switch.



This symbol indicates that the external conductor of a connector is connected to the case.



This symbol indicates that the external conductor of a connector is connected to signal ground.

Contents

	Page
1. Overview	
1.1 Features	1-1
1.2 Manual Configuration	1-2
1.3 Accessory List Used for Confirmation	1-3
2. Part Names	
2.1 ES 2000U Three-phase Master	2-1
2.1.1 Controller (top)	2-1
2.1.2 Controller (bottom)	2-2
2.1.3 Rear panel	2-3
2.1.4 Front section	2-5
2.1.5 Rear section.....	2-6
2.2 ES 2000P Three-phase Slave.....	2-7
2.2.1 Rear panel	2-7
2.2.2 Front section	2-8
2.2.3 Rear section.....	2-9
2.3 ES 2000B Booster	2-10
2.3.1 Rear panel	2-10
2.3.2 Front section	2-11
2.3.3 Rear section.....	2-12
3. Grounding and Connections	
3.1 Installation Environment	3-1
3.2 Grounding and Power Connections	3-2
3.2.1 Grounding	3-2
3.2.2 Power supply	3-2
3.3 Connections to I/O Terminals.....	3-3
3.3.1 Connection to the power input terminal	3-3
3.3.2 Connections from a single-phase three-wire distribution panel.....	3-4
3.3.3 Connections from a three-phase Δ (delta) distribution board.....	3-4
3.3.4 Connections to the output terminals.....	3-5
3.4 Connection Method for the Three-phase System with the Basic Configuration (Three-phase Master and Three-phase Slaves)	3-6
3.5 Connections for Expansion (Three-phase Master, Three-phase Slaves, and Boosters) ..	3-9
3.6 Powering On and Off and Checking Operation	3-13
4. Operations	
4.1 Notational Conventions.....	4-1
4.2 Basic Operations	4-2
4.2.1 Detaching and attaching the controller	4-2

4.2.2	Setting the output voltage and output voltage range	4-3
4.2.3	Setting the output frequency	4-4
4.2.4	Turning output on and off	4-5
4.2.5	Key lock	4-5
4.2.6	Switching between DC and AC output modes	4-5
4.2.7	Measurement function.....	4-5
4.2.8	Protection function	4-7
4.3	Advanced Operations	4-8
4.3.1	Setting limit values	4-8
4.3.2	Line synchronization	4-9
4.3.3	Memory	4-10
4.3.4	Memory storage and initial settings	4-13
4.4	Low-frequency Immunity Tests.....	4-15
4.4.1	Quick voltage change (with the frequency unchanged)	4-16
4.4.2	Voltage variation (with a frequency variation)	4-19
4.5	Obtaining Precise Output.....	4-21
4.5.1	Precision and high stability (setting of compensation mode)	4-21
4.5.2	Remote sensing AGC (AC output mode).....	4-22
4.5.3	Auto calibration (output voltage calibration function)	4-24
4.6	Using External Signals	4-26
4.6.1	External input (factory-supplied option)	4-26
4.7	Introduction of Other Products of the Same Family, Peripherals, and Options	4-29
4.7.1	4481 power supply input unit.....	4-29
4.7.2	4482 output parallel unit.....	4-29
4.7.3	ES 4473 interface board	4-30
4.7.4	ES 4474 remote terminal	4-30
4.7.5	ES 0406 low-frequency immunity test program	4-31
5.	Specifications	
5.1	Three-phase System	5-1
5.1.1	Output rating	5-1
5.1.2	Three-phase AC output	5-1
5.1.3	AC/DC output mode (valid only in single-phase operation)	5-4
5.1.4	Measurement function.....	5-4
5.1.5	AGC and remote sensing (AC output mode)	5-6
5.1.6	Auto calibration (AC output voltage calibration function)	5-7
5.1.7	Memory function	5-7
5.1.8	Limit value setting	5-7
5.1.9	Key lock	5-7
5.1.10	Low-frequency immunity tests.....	5-7
5.1.11	Three-phase/single-phase switching (option dedicated to three-phase 6-kVA systems)	5-9
5.1.12	Interface board (option).....	5-9
5.1.13	External signal input (AC output mode: factory-supplied option).....	5-10
5.1.14	Power supply input.....	5-10
5.1.15	Other information	5-10

6. Maintenance	
6.1 Cleaning the Air Filter	6-1
6.2 Backup Battery	6-2
6.3 Gain Adjustment	6-3
6.4 Operation Checks.....	6-4
6.4.1 Check method.....	6-4
7. Troubleshooting	
7.1 Error Messages	7-1
7.2 When an Error Seems to Have Occurred.....	7-2
8. Supplementary Information	
8.1 Glossary	8-1

Figures

	Page
Figure 3-1	Connections of the three-phase system with the basic configuration (three-phase master and three-phase slaves) 3-8
Figure 3-2	Connections for expansion (three-phase master, three-phase slaves, and boosters) 3-11
Figure 4-1	Detaching the controller..... 4-2
Figure 4-2	Detaching the controller..... 4-2
Figure 4-3	Fastening the controller while it faces upward 4-2
Figure 5-1	Output voltage vs. output current characteristic..... 5-2
Figure 5-2	Output frequency vs. output current characteristic 5-2
Figure 5-3	Output frequency vs. minimum load power factor allowable for supply of the maximum output current..... 5-3
Figure 5-4	Load power factor PF vs. output current..... 5-3
Figure 5-5	Output voltage vs. frequency characteristic 5-11
Figure 5-6	Total harmonic distortion rate vs. frequency characteristic 5-12
Figure 5-7	Load regulation vs. frequency characteristic..... 5-12
Figure 6-1	Detaching the air filter 6-1

Tables

	Page
Table 1-1	Packing list..... 1-3
Table 4-1	Memory storage and initial settings 4-13
Table 4-2	Supported standard tests 4-31

1. Overview

1.1	Features.....	1-1
1.2	Manual Configuration	1-2
1.3	Accessory List Used for Confirmation	1-3

1.1 Features

The “P-STATION/ES-series Programmable AC/DC Power Source” products can simulate power supply environments. Performance, functionality, compact and lightweight profiles, and ease of use are emphasized in this series. Single-phase and three-phase systems can be built by combining P-STATION/ES-series products.

A single-phase system is built with the ES 2000S single-phase master as its base and ES 2000B boosters added to obtain output power ranging from 2 kVA to 20 kVA.

A three-phase system can be built with one ES 2000U three-phase master and two ES 2000P three-phase slaves as its base. By adding ES 2000B boosters to each phase, the system can have output power ranging from 6 kVA to a maximum of 60 kVA.

Because the output voltage has low waveform distortion and features a stable voltage level and frequency, it is suitable for the power supplied in performance testing of electronic devices and EMC measurements.

The following products can be used to build a system:

- ES 2000S single-phase master
- ES 2000U three-phase master
- ES 2000P three-phase slave
- ES 2000B booster

In addition, the following options are available:

- ES 0406 low-frequency immunity test program
- ES 4153 reference impedance network
- ES 4474 remote terminal
- ES 4473 interface board
- ES 4439 three-phase/single-phase switching output unit (for three-phase 6-kVA systems)

■ Component type and cabinet type

The “P-STATION/ES-series Programmable AC/DC Power Source” comes in two types: component and cabinet. The component type allows you to use components with output power of 2 kVA, depending on the output format and power required. With this type, you can change the output power and output format by adding components or changing the combination of components. The cabinet type is an integrated product with output power of 6 kVA or higher. In comparison with the component type equipment having the same output power, the cabinet type requires less floor space for installation and I/O cables are easier to connect to it.

■ Compatibility with P-STATION/series [Q] system AC power sources

The “P-STATION/ES-series Programmable AC/DC Power Source” cannot be used with the P-STATION/series [Q] 4400-series system AC power sources.

1.2 Manual Configuration

This Instruction Manual covers three-phase systems. Manuals for these systems do not provide information about single-phase systems.

For information about options and peripherals, see the Instruction Manual supplied with the relevant product.

P-STATION/ES-series Programmable AC/DC Power Source Instruction Manuals

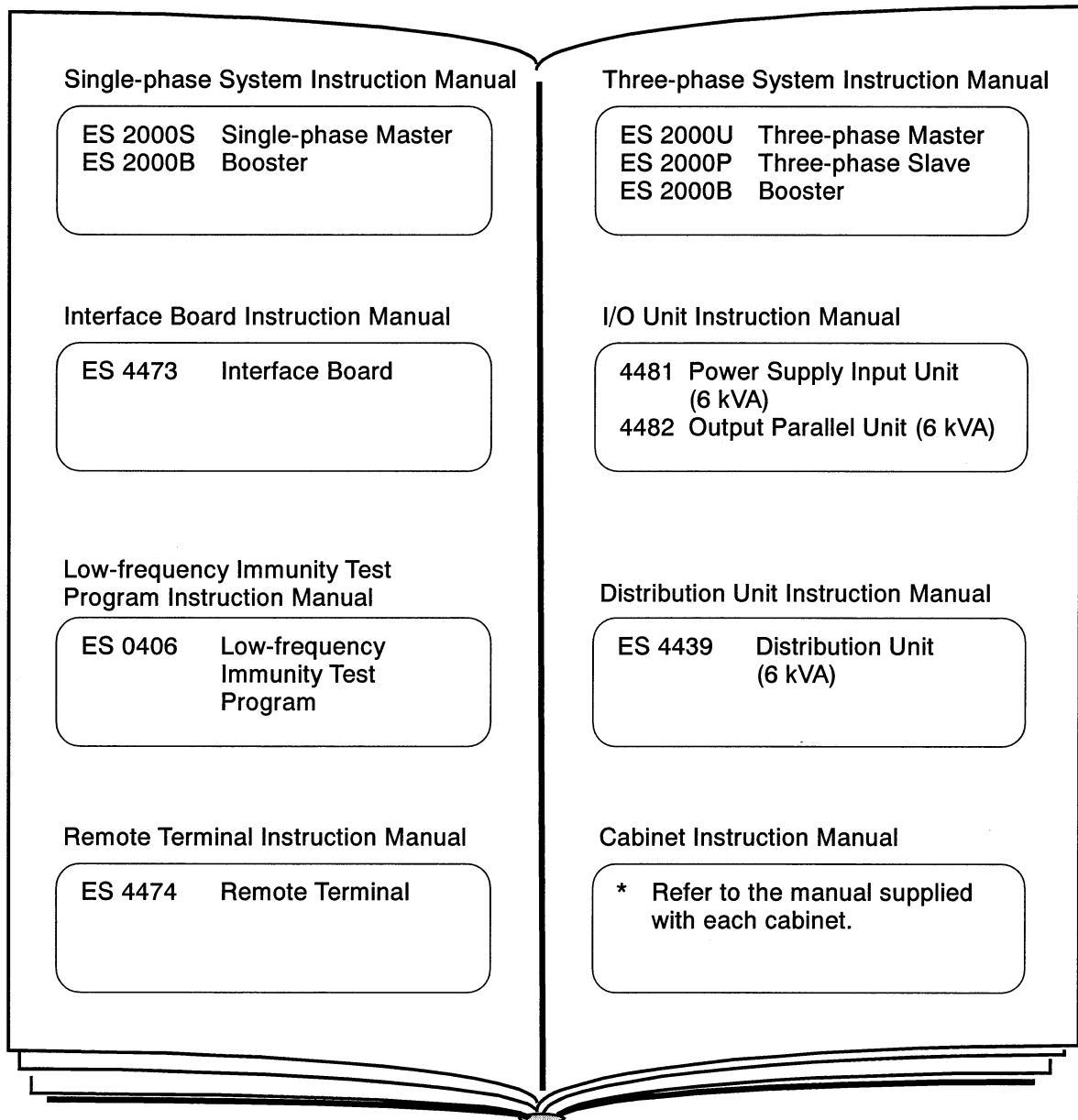

1.3 Accessory List Used for Confirmation

Before installing the equipment, check for damage caused by an accident during transport and verify that the main units and the correct accessories are all included. If a main unit or accessory is missing, contact the agent who sold you the equipment.

Table 1-1 Packing list

Item	Quantity
ES 2000U three-phase master	
Main unit	1
Instruction Manual (this document)	1
Power cable (3.5 mm ² × 3 conductors × 3m, VCT cable)	1
Flathead screwdriver for output cabling	1
ES 2000P three-phase slave	
Main unit	1
Power cable (3.5 mm ² × 3 conductors × 3m, VCT cable)	1
Three-phase control cable (with 20p round connector, approx. 400 mm)	1
ES 2000B booster	
Main unit	1
Power cable (3.5 mm ² × 3 conductors × 3m, VCT cable)	1
Booster cable A (with 16p connector, approx. 400 mm)	1
Booster cable B (with 6p connector, approx. 400 mm)	1

When re-packaging any of the devices for transport, use a box that is strong enough and large enough, and place cushioning with sufficient weight tolerance into the box in order to protect the device.

2. Part Names

2.1	ES 2000U Three-phase Master	2-1
2.1.1	Controller (top)	2-1
2.1.2	Controller (bottom)	2-2
2.1.3	Rear panel	2-3
2.1.4	Front section.....	2-5
2.1.5	Rear section	2-6
2.2	ES 2000P Three-phase Slave	2-7
2.2.1	Rear panel	2-7
2.2.2	Front section.....	2-8
2.2.3	Rear section	2-9
2.3	ES 2000B Booster	2-10
2.3.1	Rear panel	2-10
2.3.2	Front section.....	2-11
2.3.3	Rear section	2-12

2.1 ES 2000U Three-phase Master

2.1.1 Controller (top)

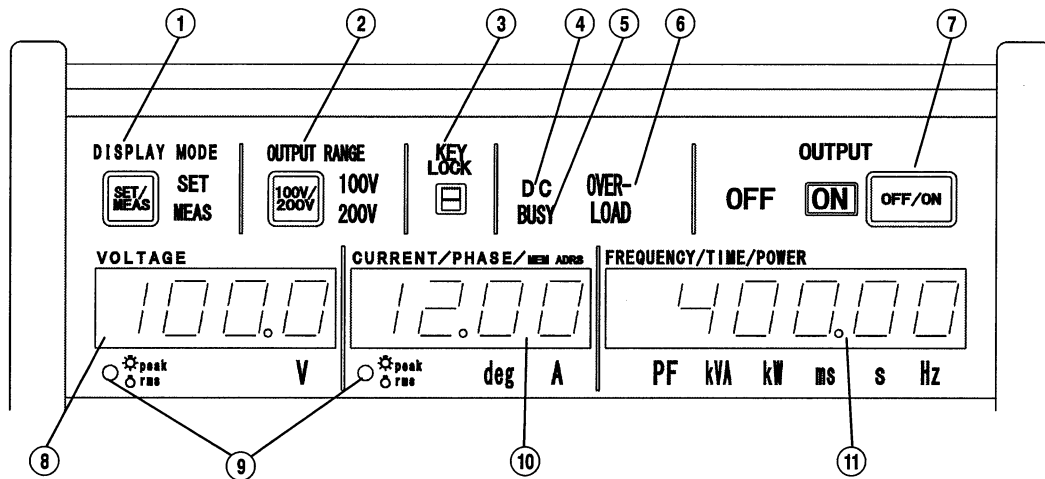

① DISPLAY MODE

Sets the display mode to “setting value” or “measurement value.”

☞ 4.2.7 Measurement function

② OUTPUT RANGE

Sets the output voltage range.

☞ 4.2.2 Setting the output voltage and output voltage range

③ KEY LOCK

Key lock switch. Setting this switch to the top position activates the lock.

☞ 4.2.5 Key lock

④ DC

Lamp is on when DC output mode is selected.

The three-phase system operates only in AC output mode.

⑤ BUSY

Lamp is on during voltage range switching.

☞ 4.2.2 Setting the output voltage and output voltage range

⑥ OVERLOAD

Lamp is on when an overload is detected. ☞ 4.2.8 Protection function

⑦ OUTPUT OFF/ON

Turns output on and off. ☞ 4.2.4 Turning output on and off

⑧ VOLTAGE

Displays the setting value or measurement value of output voltage.

☞ 4.2.7 Measurement function

⑨ **peak/rms**

Lamps indicating whether the measurement value is a peak value or effective value.
 4.2.7 Measurement function

⑩ **CURRENT/PHASE/MEM ADRS**

Displays the measurement value of output current, quick-change phase, and memory address.
 4.2.7 Measurement function, 4.4.1 Quick voltage change (with the frequency unchanged), and 4.3.3 Memory

⑪ **FREQUENCY/TIME/POWER**

Displays the output frequency, active/reactive power, power factor, quick-change time, and transition time.
 4.2.3 Setting the output frequency, 4.2.7 Measurement function, 4.4.1 Quick voltage change (with the frequency unchanged), and 4.4.2 Voltage variation (with a frequency variation)

2.1.2 **Controller (bottom)**

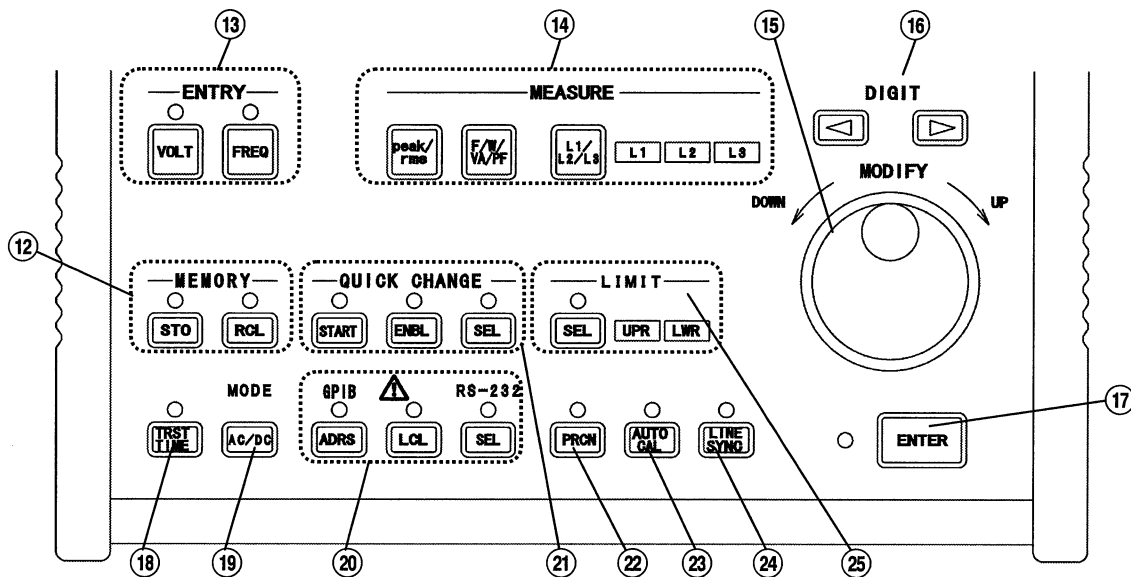

⑫ **MEMORY**

Stores and recalls settings from memory. 4.3.3 Memory

⑬ **ENTRY**

Sets the output voltage and output frequency.
 4.2.2 Setting the output voltage and output voltage range, and 4.2.3 Setting the output frequency

⑭ **MEASURE**

Used to select the measurement target. 4.2.7 Measurement function

⑮ **MODIFY**

Modify dial. It increases or decreases a setting value.

⑯ **DIGIT**

Moves the cursor in a setting to the left or right, and the digit value can be increased and decreased by the modify dial.

- ①⑦ **ENTER**
Ends the input of a setting.
- ①⑧ **TRST TIME**
Sets the transition time. 4.4.2 Voltage variation (with a frequency variation)
- ①⑨ **AC/DC**
Toggles between AC output mode and DC output mode.
The three-phase system operates only in AC output mode.
- ②⑩ **GPIB/RS-232**
Used to specify interface-related settings. This is effective only when the ES 4473 interface board is used. 4.7.3 ES 4473 interface board
- ②⑪ **QUICK CHANGE**
Used to specify settings for quick-change tests on output voltage.
 4.4.1 Quick voltage change (with the frequency unchanged)
- ②⑫ **PRCN**
Changes the compensation mode.
 4.5.1 Precision and high stability (setting of compensation mode)
- ②⑬ **AUTO CAL**
Performs auto calibration.
 4.5.3 Auto calibration (output voltage calibration function)
- ②⑭ **LINE SYNC**
Causes entry into the line synchronization state. 4.3.2 Line synchronization
- ②⑮ **LIMIT**
Sets limit values. 4.3.1 Setting limit values

2.1.3 Rear panel

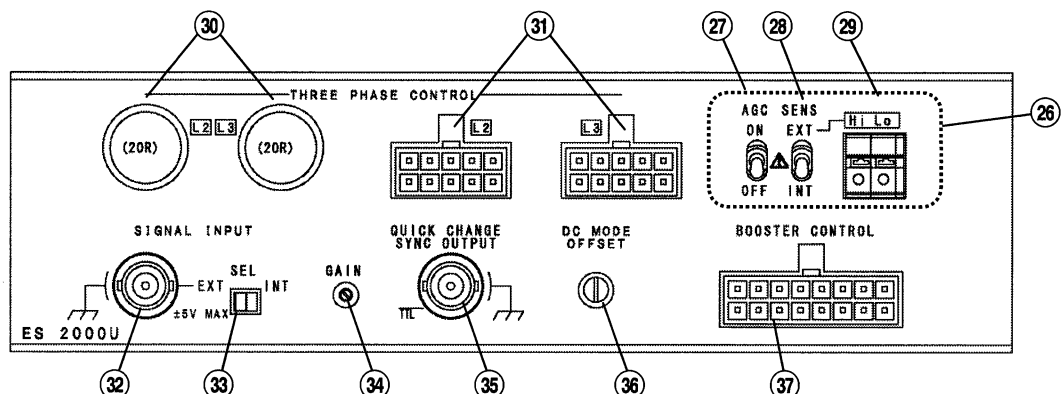

- ②⑯ **Switches and connectors related to remote sensing AGC.**
 4.5.2 Remote sensing AGC (AC output mode)
- ②⑰ **AGC**
Sets AGC operation. 4.5.2 Remote sensing AGC (AC output mode)

⑳ **SENS**

Used to select the detection point for output voltage.
☞ 4.5.2 Remote sensing AGC (AC output mode)

㉑ **Hi Lo**

Terminals used for external detection of phase L1 voltage.
☞ 4.5.2 Remote sensing AGC (AC output mode)

㉒ **THREE PHASE CONTROL**

Connector for a connection to the ES 2000P three-phase slave.
☞ 3.4 Connection Method for the Three-phase System with the Basic Configuration (Three-phase Master and Three-phase Slaves), and 3.5 Connections for Expansion (Three-phase Master, Three-phase Slaves, and Boosters)

㉓ Parts not used in this system. Leave them unconnected.

㉔ **SIGNAL INPUT connector**

Connector used for the input of external signals.
☞ 4.6.1 External input (factory-supplied option)

㉕ **SEL**

Switch for selecting an input signal. ☞ 4.6.1 External input (factory-supplied option)

㉖ **GAIN**

Adjusts the gain of the internal amplifier. ☞ 6.3 Gain Adjustment

㉗ **QUICK CHANGE SYNC OUTPUT**

Connector from which a synchronous signal is output during a quick-change operation.
☞ 4.4.1 Quick voltage change (with the frequency unchanged)

㉘ **DC MODE OFFSET**

Adjusts the offset voltage in DC output mode.
The three-phase system operates only in AC output mode.

㉙ **BOOSTER CONTROL**

Used for parallel connection using ES 2000B boosters.
☞ 3.5 Connections for Expansion (Three-phase Master, Three-phase Slaves, and Boosters)

2.1.4 Front section

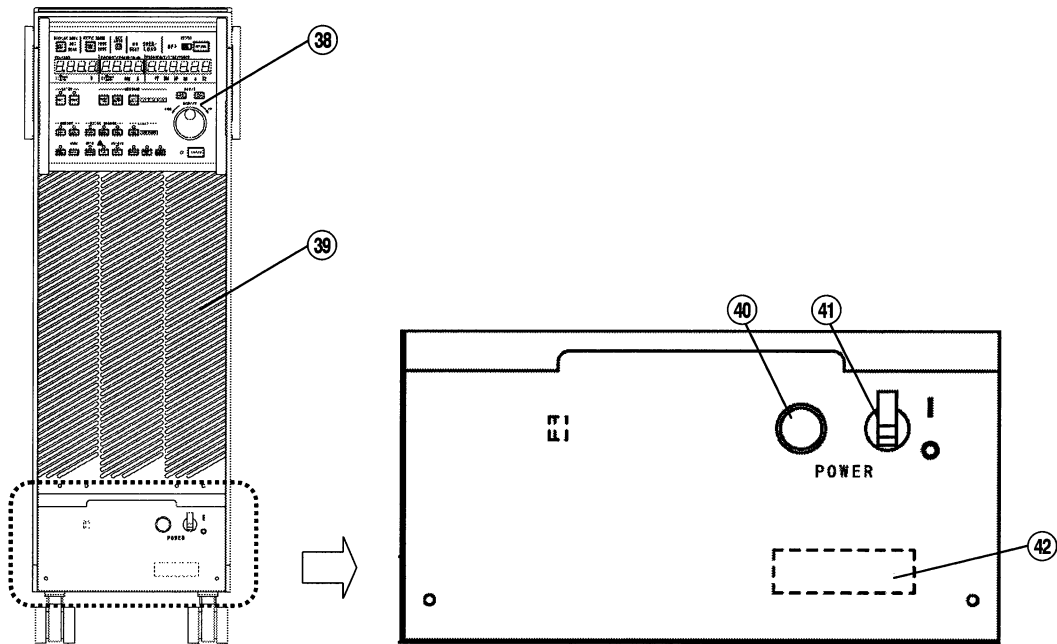

③⑧ **Controller**

③⑨ **Intake vent**

Opening through which air used for cooling enters the device.

④⑩ **POWER lamp**

Power pilot lamp. This lamp goes on when the device is turned on.

④⑪ **POWER switch**

Power switch. This switch turns on the device.

④⑫ **Serial number indication**

Serial number of the device.

2.1.5 Rear section

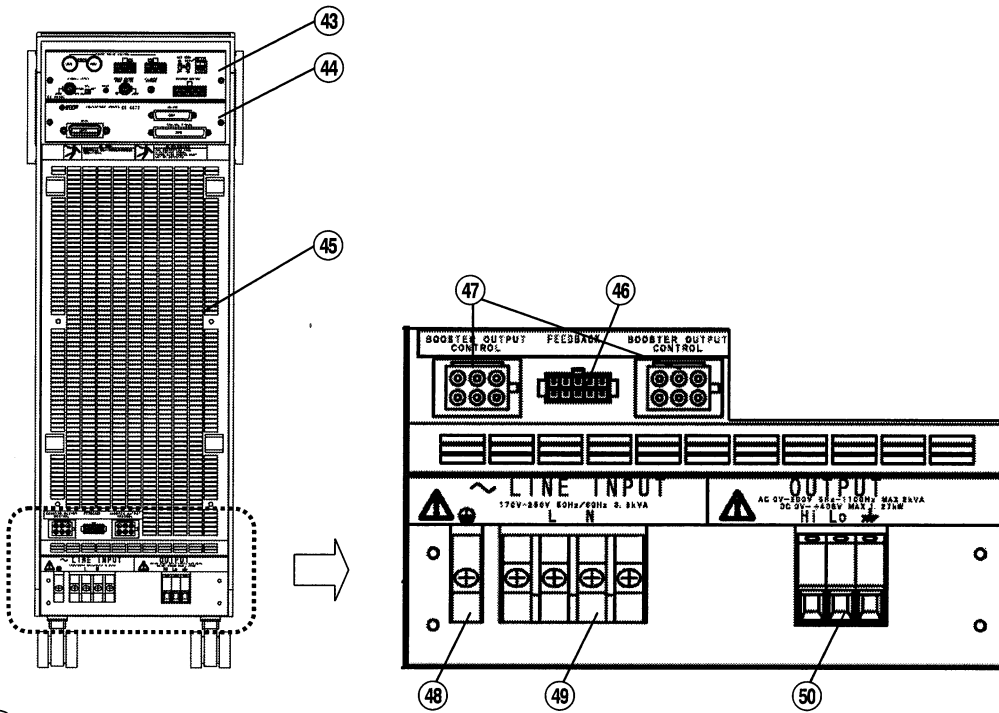

④③ **Rear panel**

④④ **Optional ES 4473 interface board**

④⑤ **Exhaust vent**

Opening through which air is blown out.

④⑥ **FEEDBACK**

Connectors provided for expandability. Leave them unconnected.

④⑦ **BOOSTER OUTPUT CONTROL**

Connector used for booster output control. For parallel connections, connect it to an ES 2000B booster.

3.5 Connections for Expansion (Three-phase Master, Three-phase Slaves, and Boosters)

④⑧

Protective ground terminal. Be sure to connect it.

3.3.1 Connection to the power input terminal

④⑨ **LINE INPUT**

Power input terminal. Be sure to note the rated input range.

3.3.1 Connection to the power input terminal

④⑩ **OUTPUT**

Output terminal. Use the screwdriver supplied.

3.3.4 Connections to the output terminal

2.2 ES 2000P Three-phase Slave

2.2.1 Rear panel

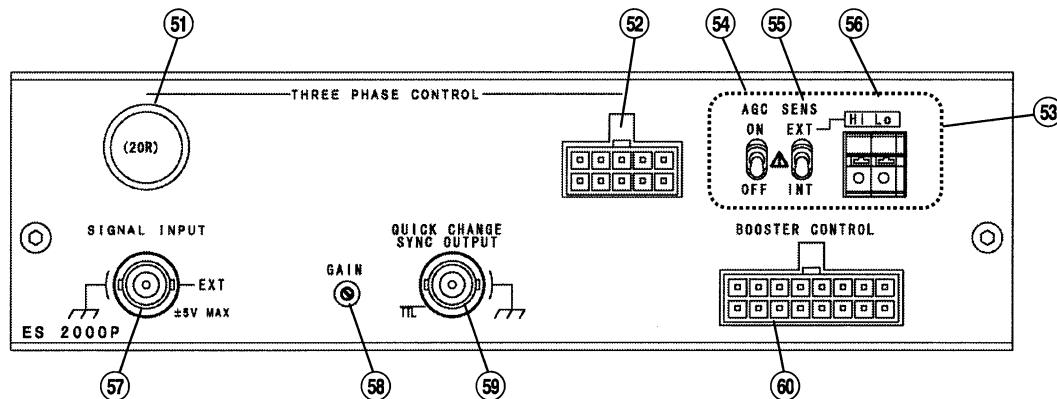

51 THREE PHASE CONTROL

Connector for a connection to the ES 2000U three-phase master.

☞ 3.4 Connection Method for the Three-phase System with the Basic Configuration (Three-phase Master and Three-phase Slaves), and 3.5 Connections for Expansion (Three-phase Master, Three-phase Slaves, and Boosters)

52 Part not used in this system. Leave it unconnected.

53 Switches and connectors related to remote sensing AGC.

☞ 4.5.2 Remote sensing AGC (AC output mode)

54 AGC

Sets AGC operation. ☞ 4.5.2 Remote sensing AGC (AC output mode)

55 SENS

Used to select the detection point for output voltage.

☞ 4.5.2 Remote sensing AGC (AC output mode)

56 Hi Lo

Terminals used for external detection of phase L2 and L3 voltage.

☞ 4.5.2 Remote sensing AGC (AC output mode)

57 SIGNAL INPUT

Connector used for the input of external signals.

☞ 4.6.1 External input (factory-supplied option)

58 GAIN

Adjusts the gain of the internal amplifier. ☞ 6.3 Gain Adjustment

59 QUICK CHANGE SYNC OUTPUT

Connector from which a synchronous signal is output during a quick-change operation.

☞ 4.4.1 Quick voltage change (with the frequency unchanged)

60 BOOSTER CONTROL

Used for parallel connections using ES 2000B boosters.

☞ 3.5 Connections for Expansion (Three-phase Master, Three-phase Slaves, and Boosters)

2.2.2 Front section

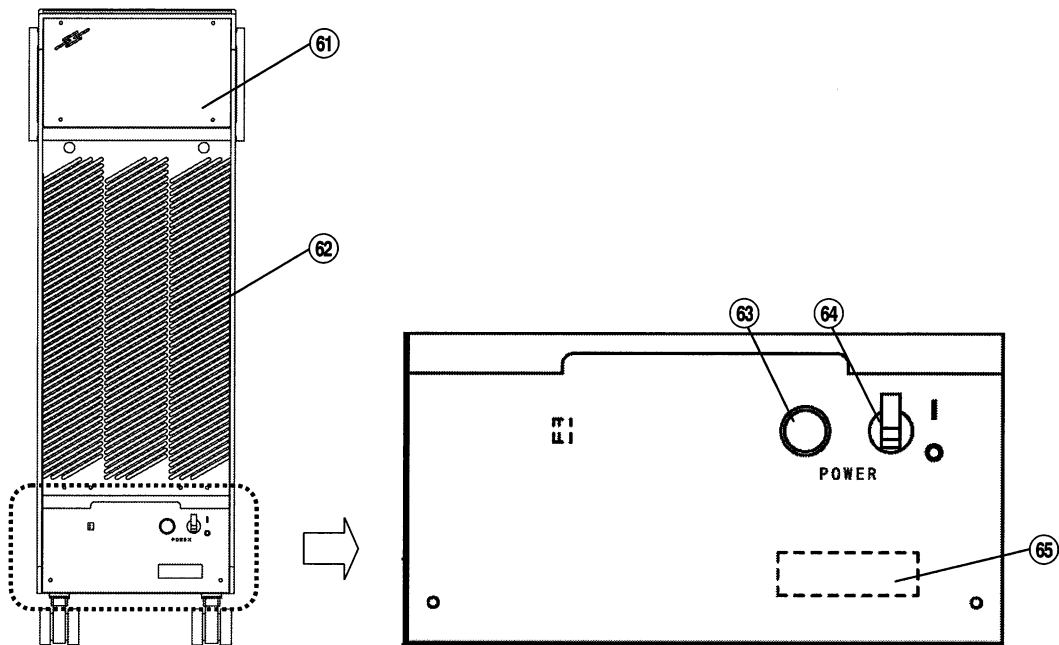

⑥1 **Blank panel**

⑥2 **Intake vent**

Opening through which air used for cooling enters the device.

⑥3 **POWER lamp**

Power pilot lamp. This lamp goes on when the device is turned on.

⑥4 **POWER switch**

Power switch. This switch turns on the device.

⑥5 **Serial number indication**

Serial number of the device.

2.2.3 Rear section

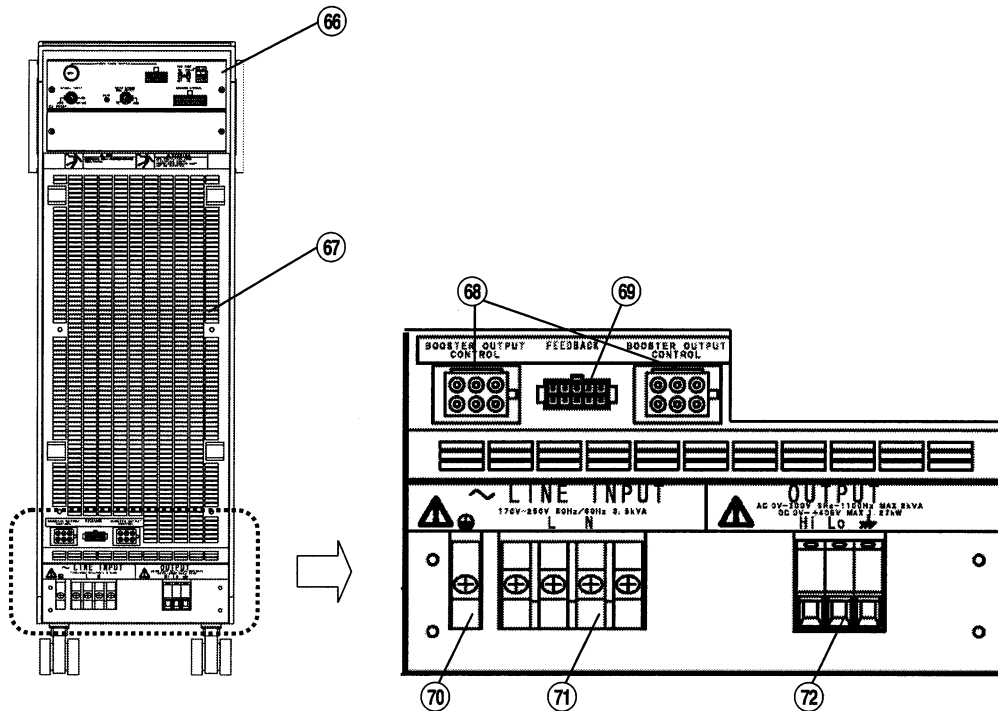

⑥⑥ **Rear panel**

⑥⑦ **Exhaust vent**

Opening through which air is blown out.

⑥⑧ **BOOSTER OUTPUT CONTROL**

Connector used for booster output control. For parallel connections, connect it to an ES 2000B booster. 3.5 Connections for Expansion (Three-phase Master, Three-phase Slaves, and Boosters)

⑥⑨ **FEEDBACK**

Connectors provided for expandability. Leave them unconnected.

⑦⑦

Protective ground terminal. Be sure to connect it.

3.3.1 Connection to the power input terminal

⑦① **LINE INPUT**

Power input terminal. Be sure to note the rated input range.

3.3.1 Connection to the power input terminal

⑦② **OUTPUT**

Output terminal. Use the screwdriver supplied.

3.3.4 Connections to the output terminal

2.3 ES 2000B Booster

2.3.1 Rear panel

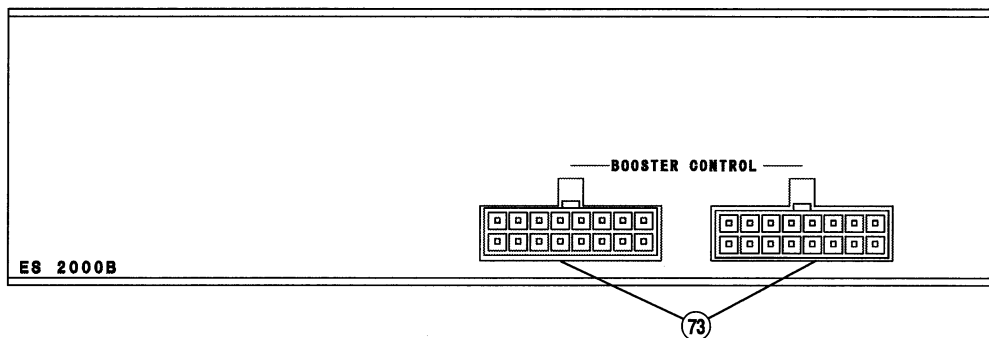

73 BOOSTER CONTROL

In parallel connections, one of them is connected to the ES 2000U three-phase master or ES 2000P three-phase slave.

By connecting the other side to another ES 2000B booster, additional boosters can be connected (up to nine boosters).

 3.5 Connections for Expansion (Three-phase Master, Three-phase Slaves, and Boosters)

2.3.2 Front section

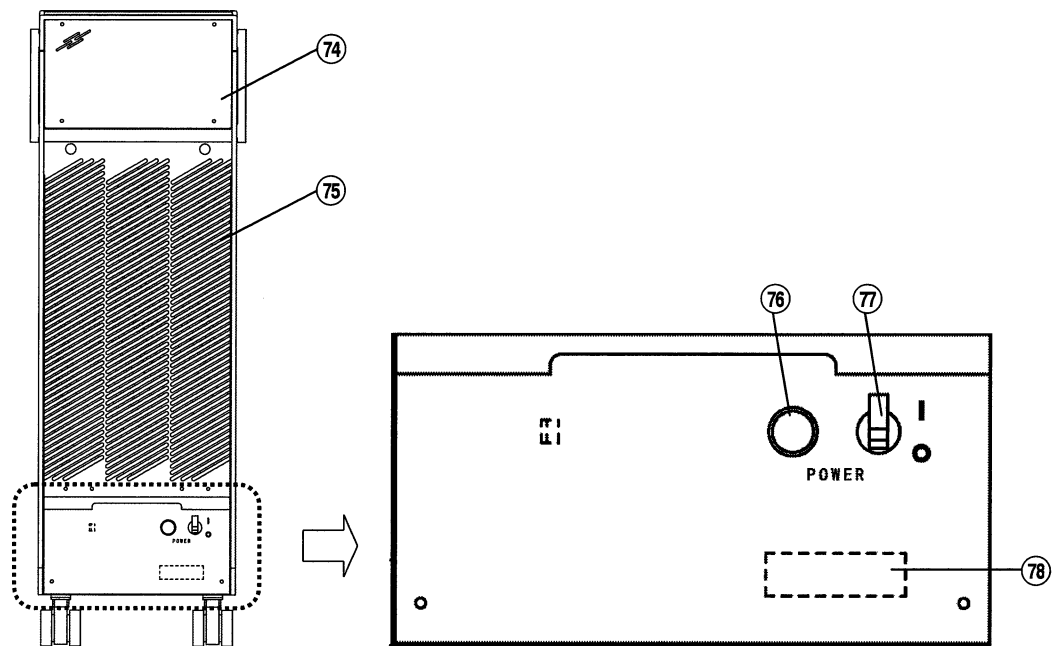

⑦④ **Blank panel**

⑦⑤ **Intake vent**

Opening through which air used for cooling enters the device.

⑦⑥ **POWER lamp**

Power pilot lamp. This lamp goes on when the device is turned on.

⑦⑦ **POWER switch**

Power switch. This switch turns on the device.

⑦⑧ **Serial number indication**

Serial number of the device.

2.3.3 Rear section

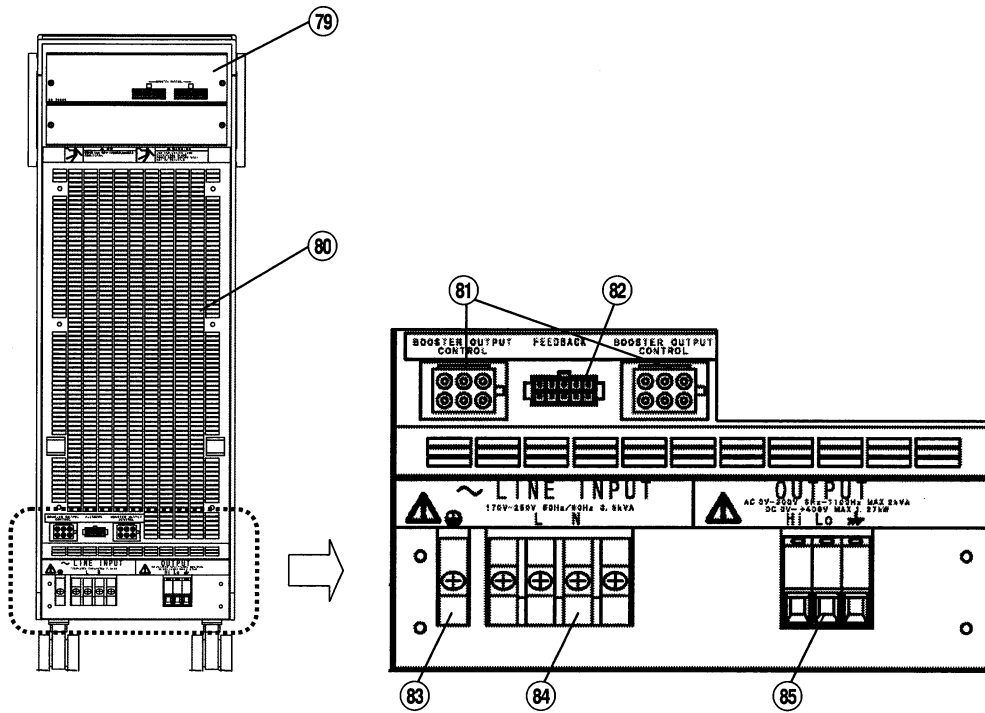

79 **Rear panel**

80 **Exhaust vent**

Opening through which air is blown out.

81 **BOOSTER OUTPUT CONTROL**

Connector used for booster output control. In parallel connections, one of them is connected to the ES 2000U three-phase master or ES 2000P three-phase slave.

By connecting the other side to another ES 2000B booster, additional boosters can be connected (up to nine boosters).

3.5 Connections for Expansion (Three-phase Master, Three-phase Slaves, and Boosters)

82 **FEEDBACK**

Connectors provided for expandability. Leave them unconnected.

83

Protective ground terminal. Be sure to connect it.

3.3.1 Connection to the power input terminal

84 **LINE INPUT**

Power input terminal. Be sure to note the rated input range.

3.3.1 Connection to the power input terminal

85 **OUTPUT**

Output terminal. Use the screwdriver supplied.

3.3.4 Connections to the output terminal

3. Grounding and Connections

3.1	Installation Environment	3-1
3.2	Grounding and Power Connections.....	3-2
3.2.1	Grounding.....	3-2
3.2.2	Power supply	3-2
3.3	Connections to I/O Terminals	3-3
3.3.1	Connection to the power input terminal.....	3-3
3.3.2	Connections from a single-phase three-wire distribution panel	3-4
3.3.3	Connections from a three-phase Δ (delta) distribution board.....	3-4
3.3.4	Connections to the output terminals.....	3-5
3.4	Connection Method for the Three-phase System with the Basic Configuration (Three-phase Master and Three-phase Slaves).....	3-6
3.5	Connections for Expansion (Three-phase Master, Three-phase Slaves, and Boosters)	3-9
3.6	Powering On and Off and Checking Operation	3-13

3.1 Installation Environment

For safe use of the devices and maintaining reliability, take the following into consideration:

- To prevent the devices from toppling over, install each one on a level floor that is vibration-free and can support their weight (approximately 48 kg per unit).
- Use the equipment within the following ambient temperature and humidity ranges:

Guaranteed performance	+5 to +35°C	5% to 80% RH The absolute humidity range is 1 to 25 g/m ³ . No condensation is allowed.
Guaranteed operation	0 to +40°C	5% to 80% RH The absolute humidity range is 1 to 25 g/m ³ . No condensation is allowed.
Storage conditions	-10 to +50°C	5% to 95% RH The absolute humidity range is 1 to 29 g/m ³ . No condensation is allowed.

In an environment with an extremely high temperature or humidity, the operation of the devices becomes less reliable. A temperature of around 25°C and a relative humidity of 50% are recommended for the operating environment of the devices.

- To get the full benefits of the forced air cooling function, install each device so that the intake vent (in the front section) and the exhaust vent (in the rear section) are at least 50 cm apart from walls and other obstructions, thereby ensuring sufficient air ventilation.
- Never install the devices at the following locations:

Outdoors

Place exposed to direct sunlight

Small area with poor ventilation

Humid place at which condensation forms easily

Dusty area

Place at which corrosive, explosive, or flammable gas is present

Place at which the device is likely to come in contact with fire or water

CAUTION

In the event of a sudden change in the ambient temperature or humidity, such as during transport in winter, condensation may form inside the device.

In such cases, leave the device as is until the condensation evaporates, before connecting it to a power supply.

3.2 Grounding and Power Connections

3.2.1 Grounding

 WARNING

This product uses a line filter, which may cause electric shock if the product is not grounded. To prevent electric shock, be sure to connect the protective ground terminal () securely to ground.

3.2.2 Power supply

 CAUTION

Before connecting the product to a power supply, make sure that the power supply voltage conforms to the rated supply voltage of the product.

- The power requirements of the product are as follows:

Voltage:	170 VAC to 250 VAC
Frequency:	48 Hz to 62 Hz
Maximum power consumption:	Approximately 3,800 VA per unit (The input current for a 170-V power supply voltage is approximately 23 A.)
- For a connection to the power supply, use the supplied power cable or an equivalent cable (with a nominal sectional area of 3.5 mm²) whose thickness is the same or greater.
- When tightening screws and pulling cables, be very careful not to allow the power cable to loosen or detach from the terminal.

3.3 Connections to I/O Terminals

Before starting connection work, be sure to disconnect the power supply from the distribution panel to prevent electric shock.

3.3.1 Connection to the power input terminal

Use the supplied power cable to connect the power input terminal (⤿ LINE INPUT) at the rear to a 200-V power supply on the distribution panel.

To ensure safety, be sure to disconnect the power supply from the distribution panel before cabling.

The input terminal section of each device is labeled (⤿ L N). Connect “⤿” to protective ground. If only one side of the power supply of the distribution panel to be connected is grounded, connect “N” to the grounded side, and connect “L” to the non-grounded side. Otherwise, you need not consider polarity.

When connecting the device to a single-phase three-wire distribution panel, make connections to the first and second phases without using the neutral phase (grounded side).

Cabling requires a Phillips screwdriver (+) used to turn the terminal block screws (M4).

Remove the safety cover of the terminal block, and remove the screw. Pass the screw through the terminal of the supplied power cable, re-insert the screw into the terminal block, and tighten the screw securely with the screwdriver.

The proper torque for tightening is 1.2 N·m (approximately 12 kgf·cm)

(from IEC standard IEC947-7-1).

Be sure to perform cabling for the protective ground terminal too. After completing cabling, be sure to mount the protective cover.

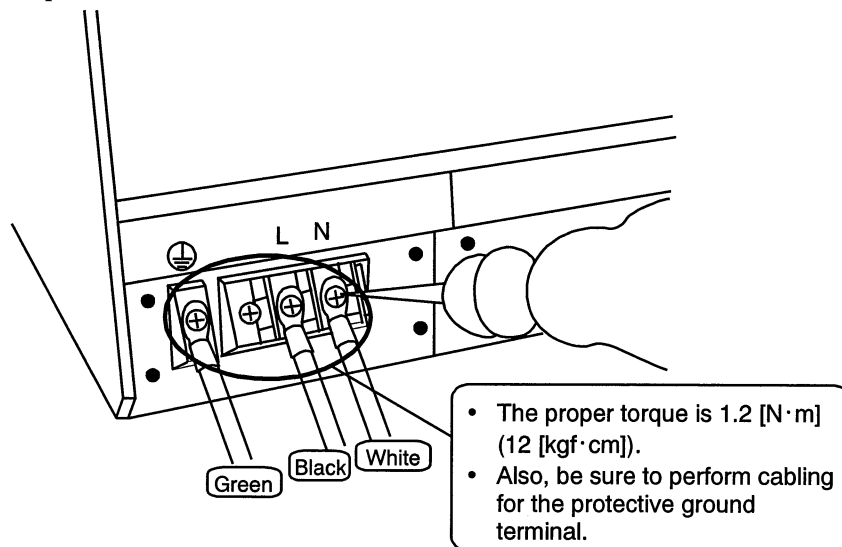

WARNING

To ensure safety, be sure to disconnect the power supply from the distribution panel before cabling.

3.3.2 Connections from a single-phase three-wire distribution panel

Connect the “L” and “N” terminals of each device to the first and second phases, respectively, without using the neutral phase (grounded side).

Do not connect the protective ground terminal of the device to the neutral phase (grounded side). Before using the device, be sure to connect this terminal to ground.

Some types of distribution panels may distribute connections in one phase of three-phase Δ connections as single-phase three-wire connections.

If a large-capacity power supply system consisting of multiple units from this series is connected to such a distribution panel, the supplied power may be concentrated in a specific phase, resulting in an unbalanced three-phase power supply system. Consider the above point before installation.

3.3.3 Connections from a three-phase Δ (delta) distribution board

Power input is insulated from output in the devices, and the system can therefore have any combination of power input connections. If you want to connect a large-capacity power supply system consisting of multiple units from this series, consider the connection configuration and how to divide the power supplied from each phase of the distribution panel equally. This is necessary to prevent the three-phase voltage from becoming unbalanced as a result of concentration of supplied power in a specific phase.

If one of the three phases of the connected power supply is grounded, connect “N” to the grounded side, and connect “L” to the non-grounded side.

3.3.4 Connections to the output terminals

Output is insulated from power input.

Both the “Hi” and “Lo” outputs are insulated from the housing. The “Lo” terminal can be connected to the housing.

An 8-mm² or thinner twisted-pair cable or a solid cable with a maximum diameter of 4 mm can be used for the output terminals at the rear.

No special preparations are required for a twisted-pair cable, but make sure that the tips of its wires do not splay.

Strip off 11 mm from the insulation jacket, insert the cable into the terminal, and fasten the terminal screws with the screwdriver supplied. The proper torque for tightening is 1.8 [N·m] (approximately 18 [kg·cm]). (The internal retaining screw is “M5.”)

⚠ CAUTION

- For cabling, use the supplied screwdriver to fasten the screws and prevent damage to the screw threads.
- Although the “Lo” terminal can be connected to the housing, connecting the “Hi” terminal to the housing prevents the system from achieving specified performance levels.

■ The following is the procedure for connecting a cable to a screw-type (clamp) terminal block:

- Step 1: Remove the cable insulator covering the conductor.
- Step 2: Loosen the screw of a terminal block and open the cable opening until it reaches its maximum size.
- Step 3: Insert the cable conductor.
- Step 4: Tighten the screw, using the specified torque.

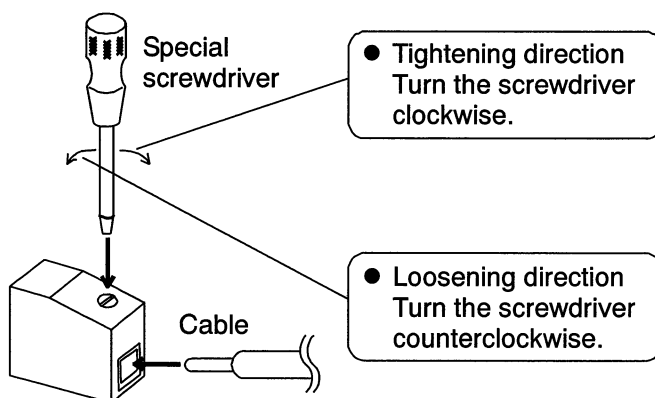

When attaching a cable to the screw-type (clamp) terminal block, insert the cable into the terminal block with its screw completely loosened.

When connecting a twisted-pair cable, make sure that the tips of its wires do not splay. Turning the fastening screw counterclockwise loosens the screw, and turning the screw counterclockwise tightens the screw.

3.4 Connection Method for the Three-phase System with the Basic Configuration (Three-phase Master and Three-phase Slaves)

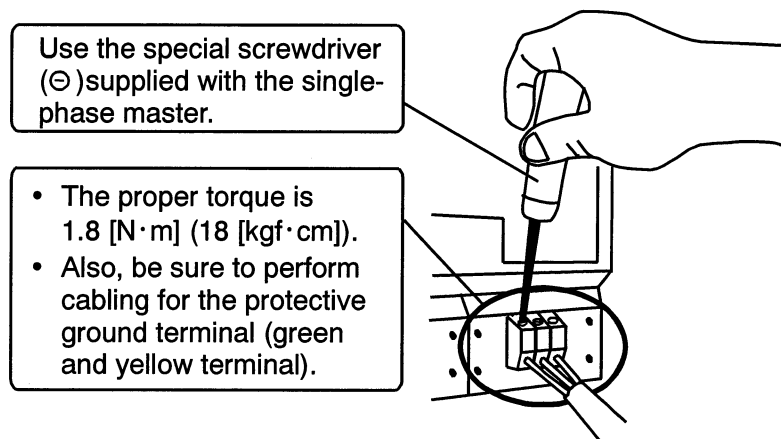

⚠ WARNING

To ensure safety, be sure to turn off the device before connecting the output terminals.

⚠ CAUTION

- Do not solder conductors. Soldered conductors have higher contact resistance, which increases the temperature of the contact part, leading to burning of the terminal block.
- Insert only one cable into a single terminal block. If more than one cable is inserted, the cables may detach easily, which is dangerous.

3.4 Connection Method for the Three-phase System with the Basic Configuration (Three-phase Master and Three-phase Slaves)

This section describes the connection method used when the ES 2000U three-phase master is connected to multiple ES 2000P three-phase slaves to configure a basic system with an output capacity of 6 kVA.

Two three-phase slaves are connected to one three-phase master. Output from each unit is set as L1 (U), L2 (V), and L3 (W), respectively, for three-phase output.

⚠ CAUTION

Before connecting cables to the power supply, check the power capacitance of the distribution panel. The maximum input power of the three-phase master and three-phase booster is approximately 3800 VA per unit, and for an input voltage of 170 V, the input current per unit is therefore approximately 23 A.

3.4 Connection Method for the Three-phase System with the Basic Configuration (Three-phase Master and Three-phase Slaves)

WARNING

To ensure safety, be sure to turn off the device before connecting the output terminals.

- (1) Connecting the power supply
See “Connections to I/O Terminals,” and connect cables securely.
Be sure to connect a separate power cable from the distribution panel to each power input pin.
- (2) Connecting the three-phase control cables
Connect the three-phase master to each three-phase slave, using the three-phase control cable supplied with the three-phase slave.
- (3) Connecting output to a load
See “Connections to I/O Terminals,” and connect cables securely. Connect output with the Y connection. Be sure to connect the L-side output of this device to the neutral phase.
The Δ (delta) connection is not permitted.

CAUTION

Connect output of each device with the Y connection.
The Δ (delta) connection is not permitted.
Be sure to connect the L-side output of the device to the neutral phase.

WARNING

An internal circuit of each device monitors voltage on the output terminals in the rear section and controls the voltage to keep it constant.
Therefore, if output current has a large peak value, or if the output frequency is high, load regulation degrades because of the effect of impedance caused by cables to the load. Examples of such impedance are those from cables and terminals. For this reason, avoid using a cable that is unnecessarily long to connect the output terminal and load, fasten the terminal screws so that there is no looseness, and use an output cable with a nominal cross-sectional area of at least about 3.5 mm².

3.4 Connection Method for the Three-phase System with the Basic Configuration (Three-phase Master and Three-phase Slaves)

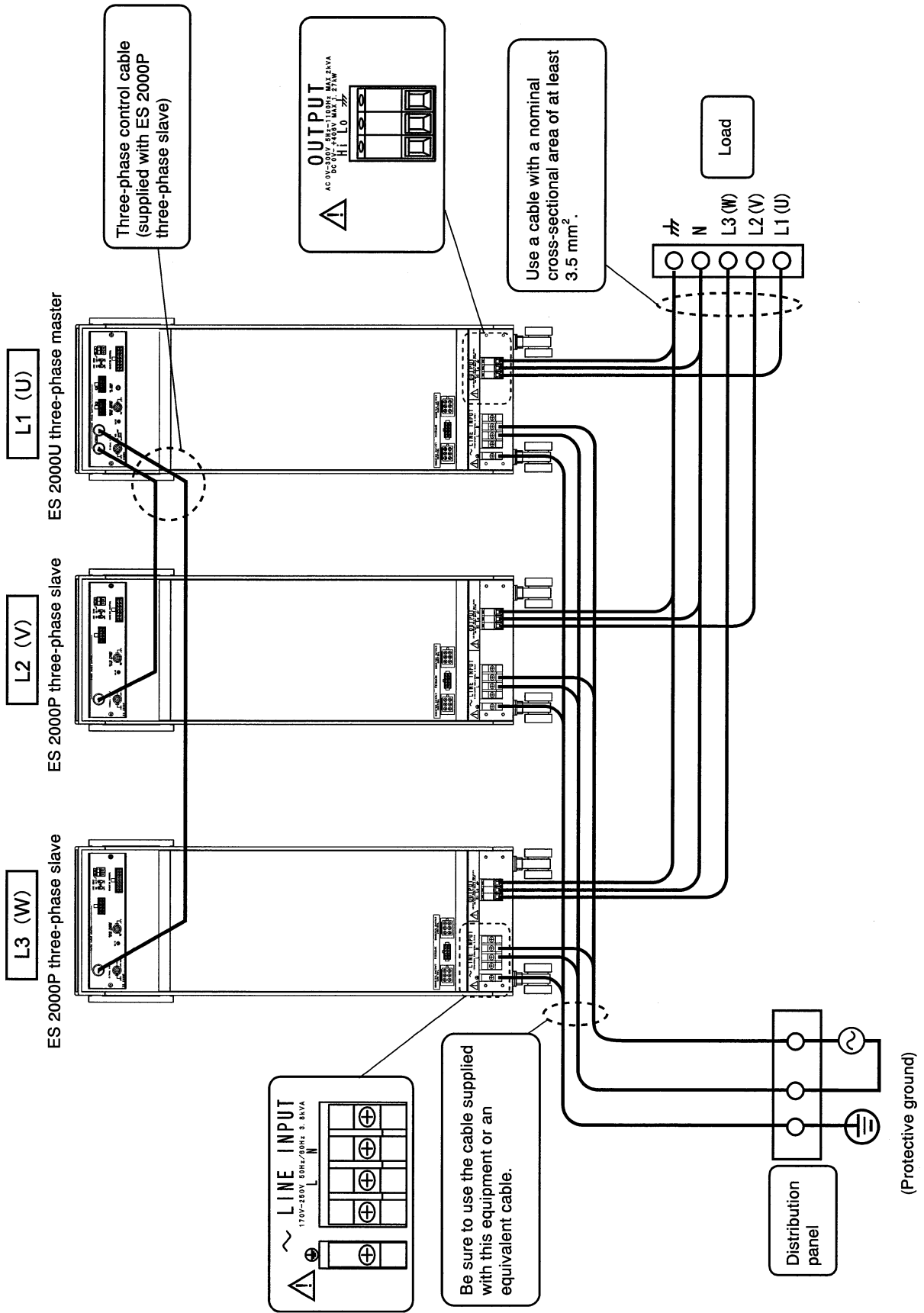

Figure 3-1 Connections of the three-phase system with the basic configuration (three-phase master and three-phase slaves)

3.5 Connections for Expansion (Three-phase Master, Three-phase Slaves, and Boosters)

This section explains how to connect additional ES 2000B boosters to a basic system (6 kVA) consisting of the ES 2000U three-phase master and ES 2000P three-phase slaves to increase output power.

The unit of expansion is 6 kVA since each unit of the basic system (which consists of one three-phase master and two three-phase slaves) has the same number of boosters connected to it for expansion.

CAUTION

Before connecting cables to the power supply, check the power capacitance of the distribution panel. The maximum input power of the three-phase master and booster is approximately 3800 VA per unit, and for an input voltage of 170 V, the input current per unit is therefore approximately 23 A.

WARNING

To ensure safety, be sure to turn off power before connecting cables.

(1) Connecting the power supply

See “Connections to I/O Terminals,” and connect cables securely.

Be sure to connect a separate power cable from the distribution panel to each power input pin.

If you want to connect a large-capacity power supply system consisting of multiple units from this series, consider the connection configuration and how to divide the power supplied from each phase of the distribution panel equally. This is necessary to prevent the three-phase voltage from becoming unbalanced as a result of concentration of supplied power in a specific phase.

(2) Connecting the three-phase control cables

Connect the three-phase master to each three-phase slave, using the three-phase control cable supplied with the three-phase slave.

(3) Connecting booster cables A and B

Connect each three-phase master and each three-phase slave to individual boosters, using booster control cables A and B, which are supplied with the booster.

(4) Connecting output to a load

See “Connections to I/O Terminals,” and connect cables securely. Connect output with the Y connection. Be sure to connect the L-side output of each device to the neutral phase.

The Δ (delta) connection is not permitted.

⚠ CAUTION

Connect output of each device with the Y connection.
The Δ (delta) connection is not permitted.
Be sure to connect the L-side output of the device to the neutral phase.

⚠ WARNING

If output current has a large peak value, or if the output frequency is high, load regulation degrades because of the effect of impedance caused by cables to the load. Examples of such impedance are those from cables and terminals. For this reason, avoid using a cable that is unnecessarily long to connect an output terminal and load, fasten the terminal screws so that there is no looseness. Also, use the output cable with a nominal cross-sectional area that is large enough for the output capacity.

 3.3.4 Connections to the output terminal

3.5 Connections for Expansion (Three-phase Master, Three-phase Slaves, and Boosters)

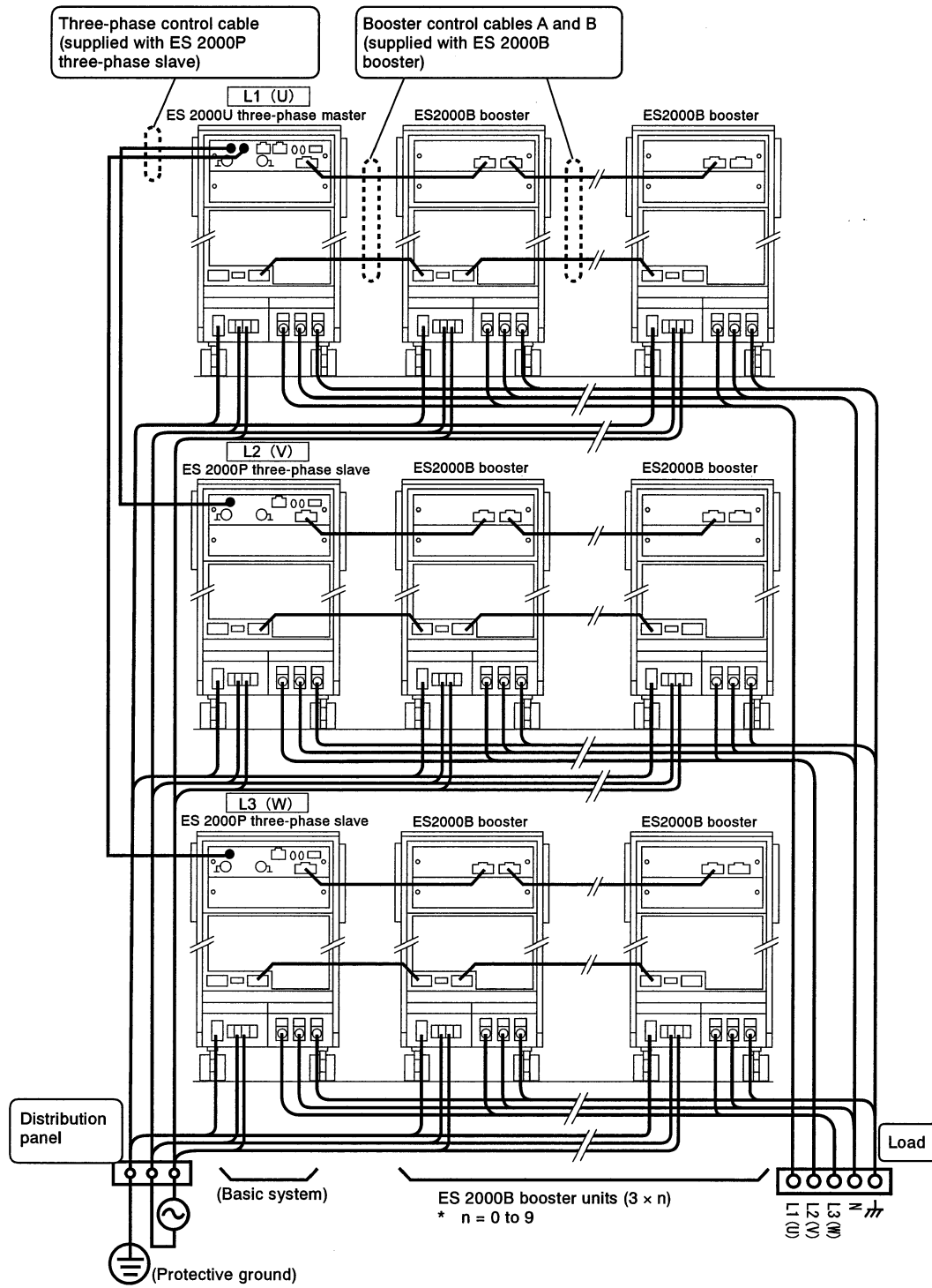

Figure 3-2 Connections for expansion (three-phase master, three-phase slaves, and boosters)

⚠ CAUTION

Select cables properly by referring to the following, which shows the relationship between cables and allowable current:

■ **Allowable current of 2-conductor vinyl cabtire cables (JIS C 3312 VCT cables)**

Ambient temperature is 30°C or less

Number of conductors	Nominal cross-sectional area (mm ²)	Allowable current (A)
Two conductors	2	22
	3.5	32
	5.5	42
	8	51
	14	71
	22	95
	38	130
	60	170
Single conductor	60	225

Ambient temperature exceeding 30°C

Ambient temperature (°C)	Allowable current derating factor
30	1.00
35	0.91
40	0.82
45	0.71
50	0.58

(As per JEAC 8001-1986)

* Multiply the allowable current in the left table by the derating factor in the above table.

■ **Relationship between cable length and voltage drop (JIS C 3307 IV cables)**

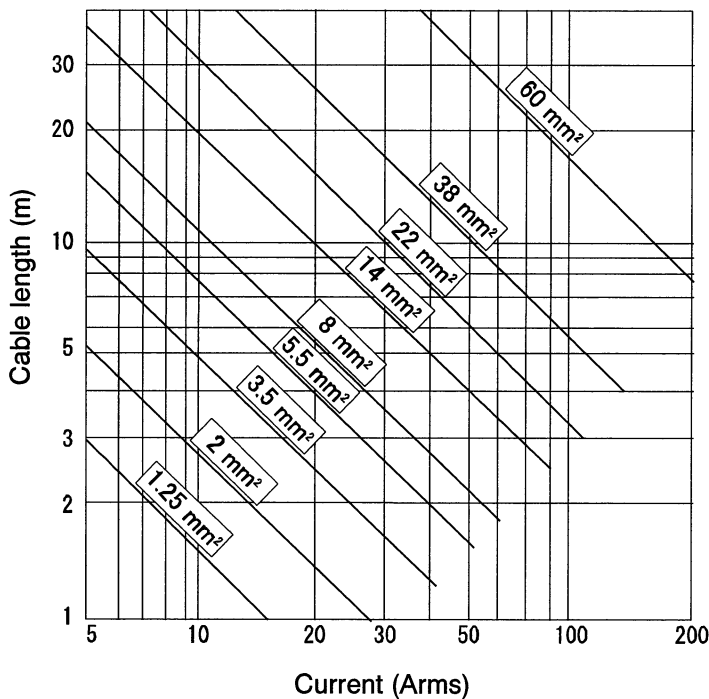

* Cable length with a voltage drop of 0.5 V caused by electric wire resistance

* In the graph, indicates a conductor cross-sectional area.

3.6 Powering On and Off and Checking Operation

After cables are connected, check operation. Power on by following the procedure below.

For explanations of indications, see Chapter 4.  4.1 Notational Conventions

- (1) If the external signal input option has been added, confirm that the SIGNAL INPUT switch on the rear panel of the three-phase master is set to INT.

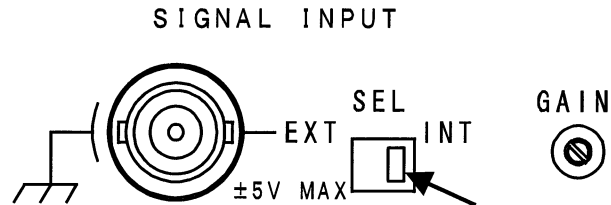

- (2) Verify that the cables are connected correctly according to the instructions given in the previous sections.
- (3) Turn on the power switches of the three-phase slaves. If the system has been expanded (boosters are connected in parallel), turn on the power switches of all boosters (the three-phase master remains powered off). The system is not yet turned on at this point.

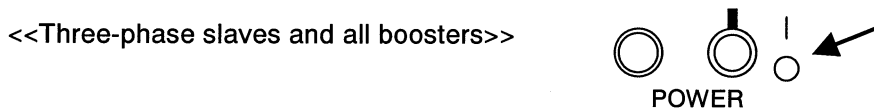

- (4) Turn on the power switch of the three-phase master. The system is turned on, and operation starts.
The three-phase slaves and each booster are automatically and sequentially turned on. This is indicated on the controller of the three-phase master.

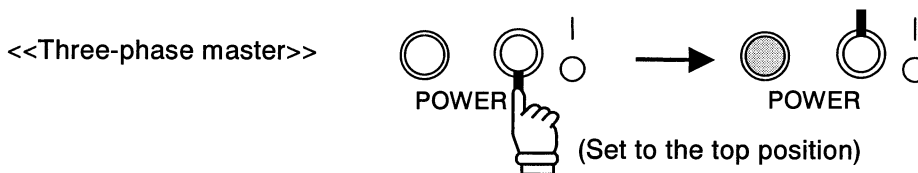

- (5) Immediately after the power-on sequence, the settings stored at memory address 1 are used. When the devices are turned on for the first time after being purchased, the preset defaults are used.  4.3.3 Memory
- (6) To power off, turn off the power switch of the three-phase master. The supply of power is stopped, and the device is turned off.
The three-phase slaves and boosters are turned off with their power switches left in the on position.

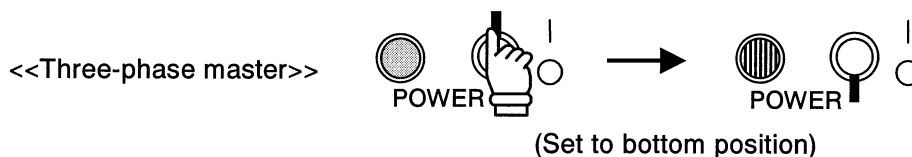

3.6 Powering On and Off and Checking Operation

- (7) After the power-off sequence, the pilot lamps of the master, slaves, and boosters blink for several seconds.

Before powering on again after the blinking pilot lamps go out, wait at least 10 seconds.

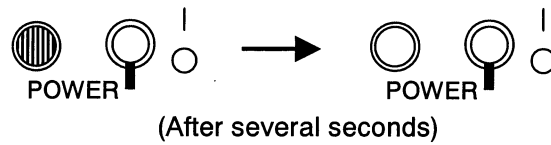

CAUTION

- Connect cables securely. An incorrect connection can result in a malfunction.
 - Immediately after the power-on sequence,  may go on and remain on until the internal circuit stabilizes.
-

4. Operations

4.1	Notational Conventions.....	4-1
4.2	Basic Operations	4-2
4.2.1	Detaching and attaching the controller.....	4-2
4.2.2	Setting the output voltage and output voltage range	4-3
4.2.3	Setting the output frequency	4-4
4.2.4	Turning output on and off	4-5
4.2.5	Key lock.....	4-5
4.2.6	Switching between DC and AC output modes.....	4-5
4.2.7	Measurement function.....	4-5
4.2.8	Protection function.....	4-7
4.3	Advanced Operations	4-8
4.3.1	Setting limit values	4-8
4.3.2	Line synchronization.....	4-9
4.3.3	Memory.....	4-10
4.3.4	Memory storage and initial settings.....	4-13
4.4	Low-frequency Immunity Tests	4-15
4.4.1	Quick voltage change (with the frequency unchanged)	4-16
4.4.2	Voltage variation (with a frequency variation)	4-19
4.5	Obtaining Precise Output.....	4-21
4.5.1	Precision and high stability (setting of compensation mode)	4-21
4.5.2	Remote sensing AGC (AC output mode)	4-22
4.5.3	Auto calibration (output voltage calibration function)	4-24
4.6	Using External Signals	4-26
4.6.1	External input (factory-supplied option).....	4-26
4.7	Introduction of Other Products of the Same Family, Peripherals, and Options	4-29
4.7.1	4481 power supply input unit.....	4-29
4.7.2	4482 output parallel unit.....	4-29
4.7.3	ES 4473 interface board.....	4-30
4.7.4	ES 4474 remote terminal.....	4-30
4.7.5	ES 0406 low-frequency immunity test program.....	4-31

4.1 Notational Conventions

This section explains the notations used to explain device operations.

(1) Notations of indications

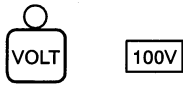

A lamp is off.



A lamp is on.

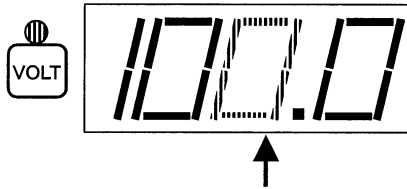

A lamp or indicator is blinking. The arrow indicates which digit on the display is blinking.

(2) Notations of operations



This indicates the pressing of a key.
You need not hold down the key.

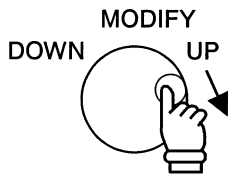

This indicates the turning of a dial.
This figure shows that the dial is turned clockwise.

CAUTION

To better understand the methods of use, operate the device as you read this section.

4.2 Basic Operations

4.2.1 Detaching and attaching the controller

You can detach the controller of the three-phase master and then use it.

Choose the desired mode of use according to your purposes.

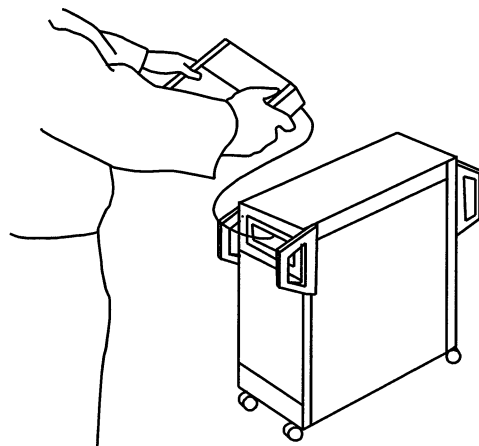

Figure 4-1 Detaching the controller

To detach the controller, first gently pull the bottom of the controller.

When the controller is detached from the retaining magnets, raise the bottom edge, and pull out the controller from the socket located behind it to separate the controller from the main unit. Two other sockets are provided so that you can mount and fasten the controller while it faces slightly upward.

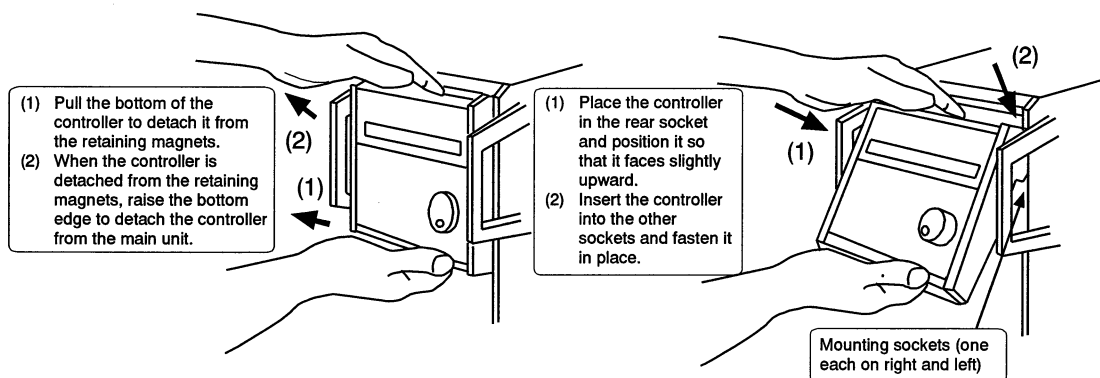



Figure 4-2 Detaching the controller

Figure 4-3 Fastening the controller while it faces upward



⚠ CAUTION

- When detaching or attaching the controller, be careful not to drop it. Attach the controller securely, and be careful not to drop the controller during transport.
- To prevent the cable from breaking, do not pull the cable with excessive force.

4.2.2 Setting the output voltage and output voltage range

- After setting an appropriate output voltage range for a target output voltage, place the device in the voltage setting state, and set the voltage by turning the modify dial.
- The upper limit of output voltage depends on the output voltage range setting and limit setting.
- The voltage setting steps of the dial depend on whether the mode is setting mode or measurement mode. In setting mode, you can change the step value by pressing the  and  keys, but in measurement mode, the step value is always set to 0.1 V.

■ Operating procedure

Press the  key to set the output voltage range to the desired range. Each time the key is pressed, the range setting toggles between the two ranges. During the switching operation,  remains on.

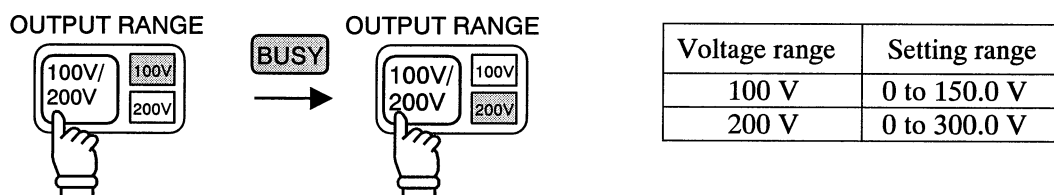

Press the  key to place the device in the voltage setting state. The lamp goes on.

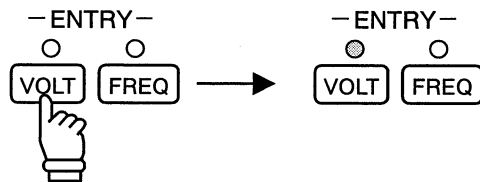

Turn the modify dial to set a voltage. The output voltage value changes together with the displayed value.

In setting mode, the value indicated by the blinking digit changes; in measurement mode, the value indicated by the 0.1-V digit changes.

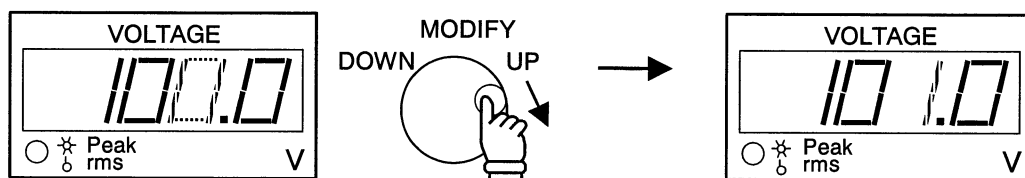

To end this setting operation, press the  key. The lamp goes out, and the voltage setting state ends.

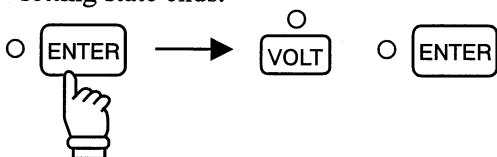

⚠ CAUTION

The maximum output current depends on the output voltage range. Select an appropriate range according to the load current.

4.2.3 Setting the output frequency

- Place the device in the frequency setting state, and set the frequency by turning the modify dial.
- The maximum frequency range is 5 to 1100 Hz, but if limit values are set (☞ 4.3.1 Setting limit values), the upper and lower limits are determined according to those settings.

■ Operating procedure

Press the **SET/MEAS** key to set the display mode to setting mode. **SET** goes on.

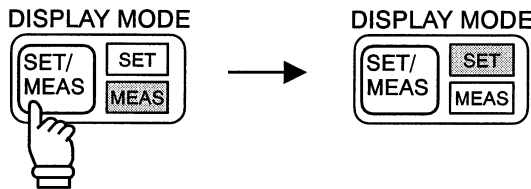

Press the **FREQ** key to place the device in the frequency setting state. Its lamp goes on.

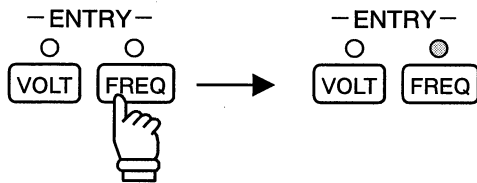

Turning the modify dial changes the value indicated by the blinking digit. The cursor indicated by the blinking digit is moved when the **←** or **→** key is pressed. The output frequency changes together with the displayed value.

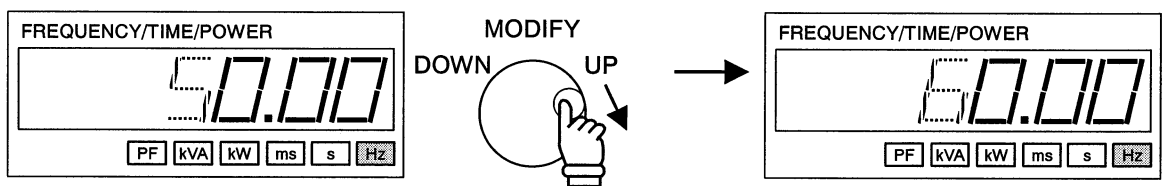

To end this setting operation, press the **ENTER** key. The lamp goes out, and the voltage setting state ends.

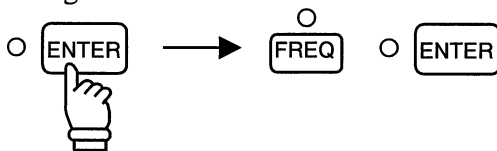

⚠ CAUTION

- When setting a frequency, be sure to note the allowable frequency range of the connected load.
- When line synchronization is set to on, the frequency cannot be set. Before attempting to set the frequency, turn off line synchronization.
☞ 4.3.2 Line synchronization

4.2.4 Turning output on and off

Output can be turned on and off.

■ Operating procedure

Press the **OFF/ON** key. Each time the key is pressed, the output is alternately turned on and off.

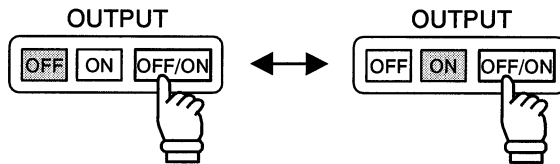

4.2.5 Key lock

When the key lock switch is slid to the top position, the switch knob is activated and the key lock state is entered. In this state, key input from the front panel is not accepted.

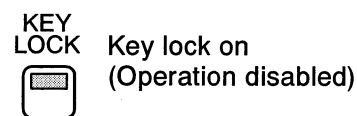
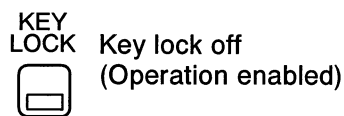

4.2.6 Switching between DC and AC output modes

The three-phase system can operate only in AC output mode. You cannot switch to DC output mode.

4.2.7 Measurement function

- The effective values and peak values of voltage and current, active power, apparent power, and the power factor can be measured.
- Output voltage can be changed while the measurement display mode is maintained.

4.2.2 Setting the output voltage and output voltage range

■ Operating procedure

Press the **SET/MEAS** key to set the display mode to measurement mode. **MEAS** goes on.

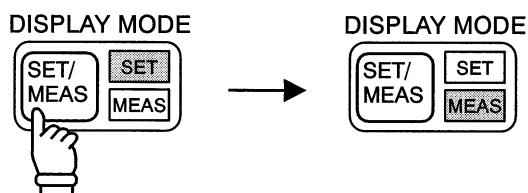

<<Displaying the effective values and peak values of voltage and current>>

Press the **Peak/rms** key. When the lamp is on, a peak value is displayed; when off, an effective value is displayed.

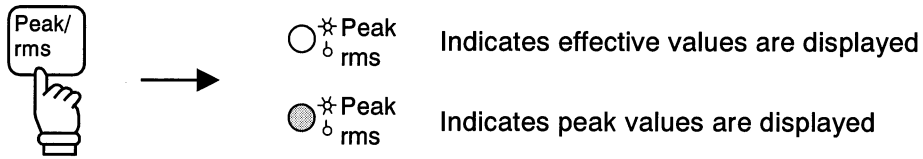

<<Displaying active power, apparent power, and the power factor>>

Press the **F/W/VA/PF** key. Each time the key is pressed, the value of a different measurement is displayed. The display sequence is as follows: frequency (Hz) → active power (kW) → apparent power (kVA) → power factor → frequency (Hz) → ...

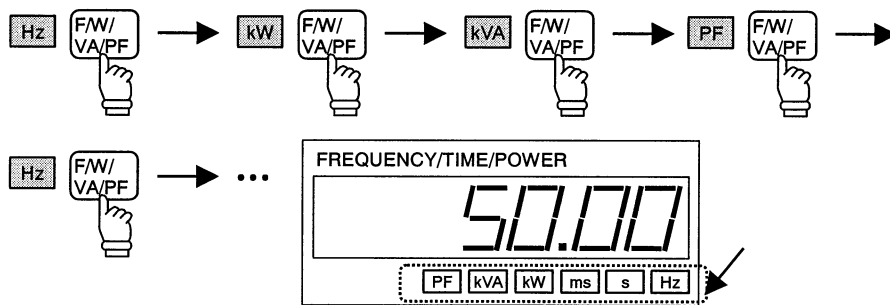

<<Selecting the measurement phase>>

Press the **L1/L2/L3** key. Each time the key is pressed, the selected measurement phase is changed. The sequence of the change is as follows:

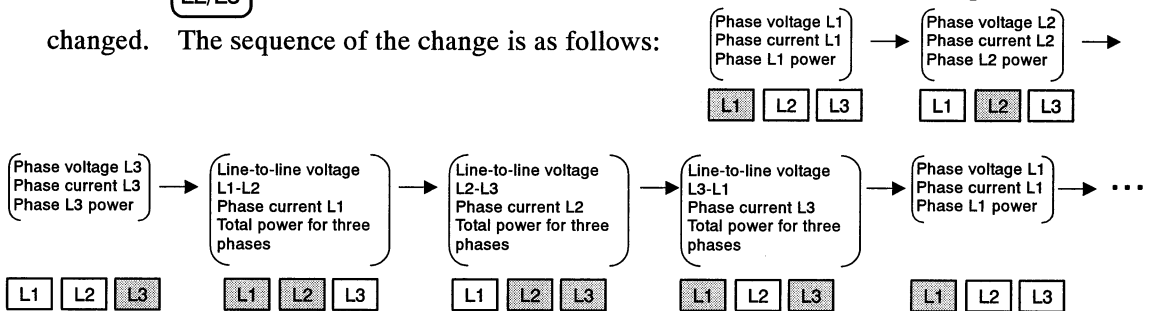

The indicated L1, L2, and L3 phases correspond to U, V, and W, respectively.

CAUTION

- Measured frequency values are not displayed. (Only the setting is displayed.)
- Operations with the **Peak/rms** and **F/W/VA/PF** keys cannot be accepted while the display mode is set to setting mode (**SET** is on). When either of these keys is pressed, it may take several seconds until stable values are displayed.

4.2.8 Protection function

- The device provides the protection function explained below.
- When output is restricted, the overload state is entered, and **OVER-LOAD** goes on.

Protection factor	Protection status		Outline of operation
	Output restriction	Power disconnection	
Output overcurrent	Yes	Yes	At the same time that the peak value of current is detected and restricted, the mean value is detected and restricted by a decrease in the input voltage.
Output element loss	Yes	Yes	If semiconductor loss in the output stage exceeds a specified value, it is restricted by a decrease in the input voltage.
Output element in safe operation area	Yes	Yes	If the safe operation area of a semiconductor in the output stage exceeds a specified value, output voltage and current are restricted.
Heat in internal elements	No	Yes	A protective operation takes place when the ambient environment or a fan failure causes a detected decline in cooling capability.

CAUTION

In a protective operation for restricting output, the device is placed in the overload protection state, and **OVER-LOAD** goes on. When the cause of the restriction (e.g., overload or short-circuit) is corrected, self-restoration to the normal state is performed, but depending on the degree or time of the protection state, power is sometimes turned off.

Primarily during remote sensing AGC ( 4.5.2 Remote sensing AGC (AC output mode)), if the external sensing terminal becomes available with output left on or if output exceeds the voltage compensation range, the protection function turns off the compensation operation, and turns on **OVER-LOAD**. This state continues until output is turned off.

Also, the lamp may go on for a short time when the voltage range is changed.

4.3 Advanced Operations

4.3.1 Setting limit values

- By setting limit values, the setting ranges of output voltage and output frequency can be restricted. If you set appropriate limit values for the allowable input range of the connected load in advance, you can prevent load failures, such as those resulting from applying overvoltage.
- Three types of limits can be set: upper voltage limit, upper frequency limit, and lower frequency limit.
- The setting of the quick-change voltage is restricted by the set limit values.
 4.4.1 Quick voltage change (with the frequency unchanged)

■ Operating procedure



Press the key to set the display mode to setting mode.

4.2.7 Measurement function

Pressing the key displays the three limit values that are currently set.

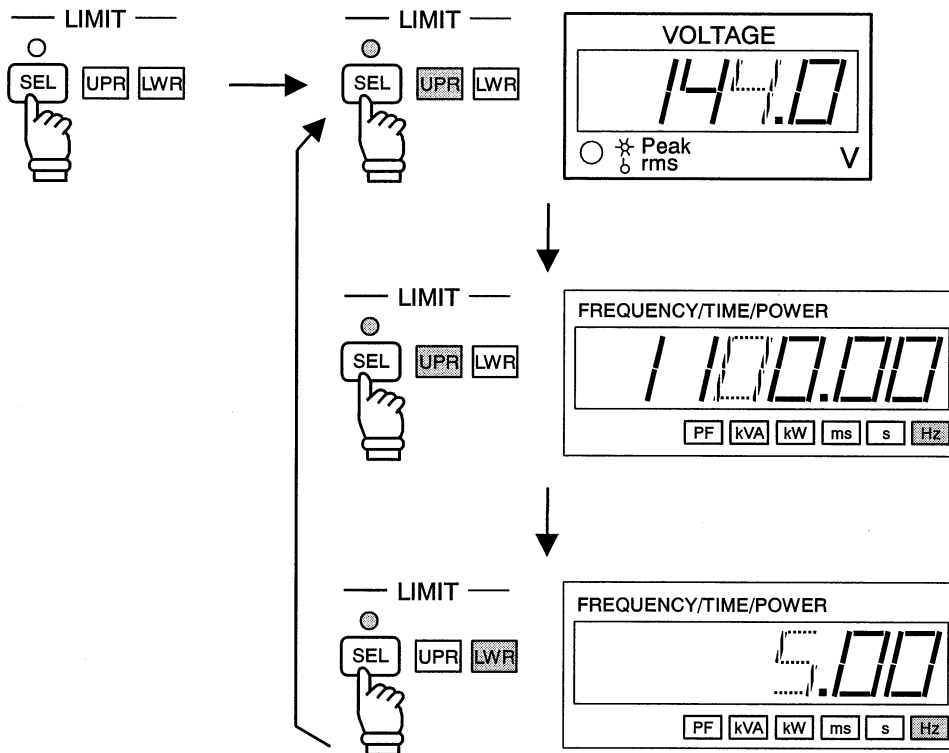
In the value displayed, one digit is indicated by the cursor. Each time the key is pressed, the cursor moves to the next value displayed. The display sequence is as follows: upper voltage limit (V) → upper frequency limit (Hz) → lower frequency limit (Hz) → upper voltage limit (V) → Move the cursor to the limit setting you want to set.



Specify a limit value by turning the modify dial. You can move the cursor by pressing the  and  keys.

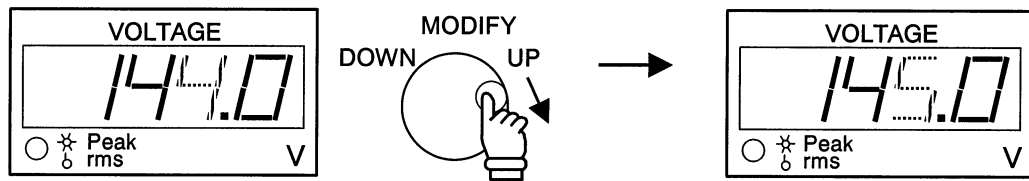

After specifying a value, press the **ENTER** key. The basic display state that was set prior to the **SEL** key being pressed is restored, and the setting operation ends.

To check the set value, press the **SEL** key again to enter the setting state.

To specify a value for another limit setting, repeat the procedure from the beginning.

CAUTION

A value less than the currently set values of output voltage and quick-change voltage cannot be set as the voltage limit value.

Similarly, values exceeding the currently set frequency range cannot be set as the upper and lower frequency limit values.

4.3.2 Line synchronization

This function synchronizes the output frequency with the frequency of the AC current line. Synchronization is possible with power line frequencies ranging from 48 to 62 Hz.

■ Operating procedure

Turn off output. When output is on, line synchronization cannot be turned on or off.

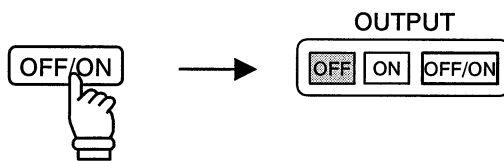

Press the **LINE SYNC** key. After waiting for stabilization (approximately 100 ms), the frequency display changes to “LInE”, and output is synchronized.

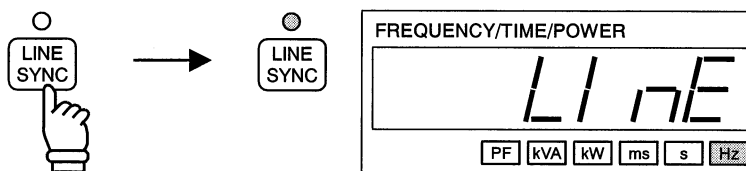

To turn off line synchronization, turn off output, then press the  key.

While line synchronization is turned off, the output frequency is always set to 55 Hz.

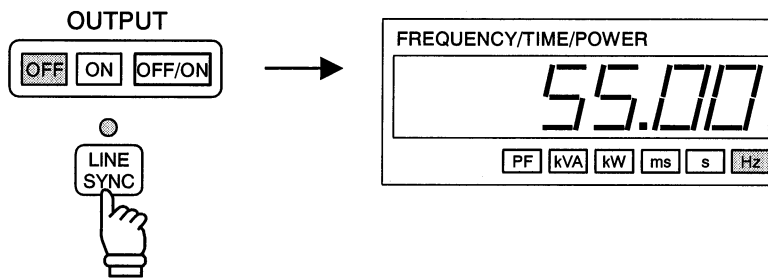

CAUTION



The frequency range that can be used for line synchronization is from 48 to 62 Hz, which is the same as the rated frequency range of the devices. Use frequencies within this range.

When output is on, line synchronization cannot be turned on or off. Before setting a value, turn off output.

While line synchronization is turned off, the output frequency is always set to 55 Hz.

If the allowable frequency setting range determined by set frequency limit values ( 4.3.1 Setting limit values) does not include 55 Hz, line synchronization cannot be turned on.

4.3.3 Memory

- Setting values and states can be stored in backup memory supported by an internal battery, so they can later be recalled from memory.
- There are 121 memory addresses, from 0 to 120. Initial values are stored at address 0 and can only be recalled from memory. Any state can be stored at the remaining 120 addresses.
- During the power-on sequence, the contents of address 1 are set. If you store a frequently used state at address 1, you do not need to specify settings each time you use the device .
- Using the state settings stored in memory enables the quick output change operation that changes output quickly between the states before and after a recall operation. Furthermore, setting a transition time ( 4.4.2 Voltage variation (with a frequency variation) enables a sweep operation that changes the voltage or frequency of output for the set time, between the states before and after the recall operation. For details, see “Low-frequency Immunity Tests.”  4.4 Low-frequency Immunity Test

⚠ CAUTION

- ① In a memory recall operation with output turned on, the device operates as follows so as not to mistakenly supply output to the load:
 - With “output off” set as the state to be entered after the memory recall
After the memory recall, “output off” is always set.
 - With “output on” set as the state to be entered after the memory recall
If any of the state settings listed below has a different value before the memory recall than that after the memory recall, “output off” is set to ensure reliable operation.
If the state setting remains the same, however, output remains on.
 - Line synchronization on/off
 - Quick-change enable mode
 - Output voltage range 100 V/200 V
 - Precision/high stability
 - Output mode AC/DC
 - Crest factor function enabled/disabled (If enabled, the CF value must be the same before and after the memory recall.)
 - ② Although the contents of address 1 are recalled during the power-on sequence, output is always turned off regardless of the stored contents so as not to mistakenly supply output to the load.
 - ③ When a sweep is not to be used, check whether the transition time would be set to 0 at the time of the save operation to make sure that the sweep operation is not performed by mistake.
☞ 4.4.2 Voltage variation (with a frequency variation)
 - ④ The interface-related settings used when the optional ES 4473 interface board is installed are not stored in memory and cannot be recalled from memory. For details, see the ES 4473 Interface Board Instruction Manual.
 - ⑤ When the optional ES 4474 remote terminal is used, additional states can be stored in and recalled from memory. For details, see the ES 4474 Remote Terminal Instruction Manual.
 - ⑥ When the output sweep operation is not to be used, set the transition time to 0.
☞ 4.4.2 Voltage variation (with a frequency variation)
-

■ Operating procedure: Memory storage

Press the **[STO]** key. The lamp blinks, a memory address is displayed, and the device enters the setting state.

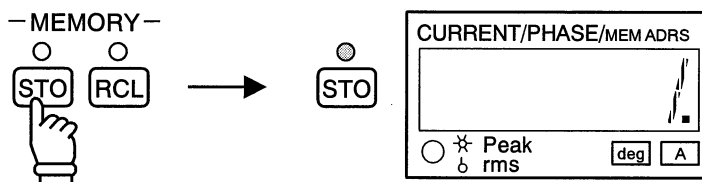

Select a memory address by turning the modify dial. Address 0 is used only for memory recall, so it cannot be set for the save operation.

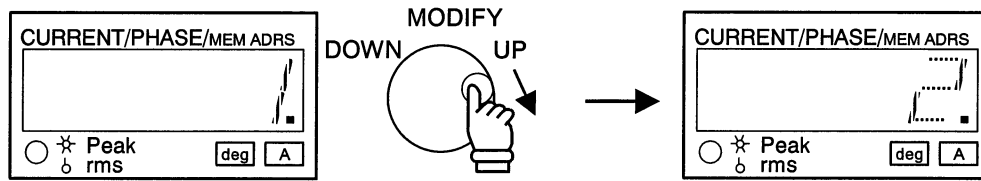

After selecting the desired address for the save operation, press the **ENTER** key. The states at this point in time are saved, the lamp goes out, and the setting state ends.

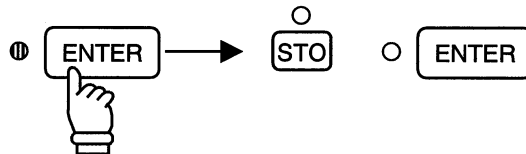

■ **Operating procedure: Memory recall**

Press the **RCL** key. The lamp goes on, a memory address is displayed, and the device enters the setting state. The output voltage or frequency value stored at that address is then displayed, which can help you select the address whose contents are to be recalled.

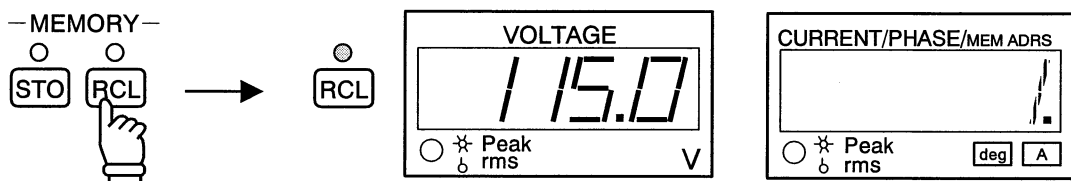

Select a memory address by turning the modify dial.

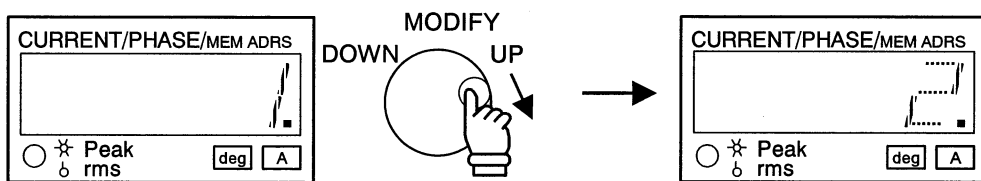

After selecting the address whose contents you want to recall, press the **ENTER** key. The lamp goes out, the memory contents are recalled, a state change occurs, and the setting state ends.

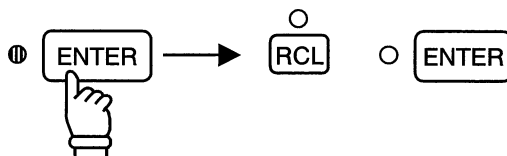





4.3.4 Memory storage and initial settings

Table 4-1 Memory storage and initial settings

Setting	Memory storage enabled	Initial setting (recalled from address 0)
Output voltage	Yes	0.0 V
Output voltage range	Yes	100-V range
Output frequency	Yes	50.00 Hz
Output on/off	(*1)	Off
Key lock	No (*2)	
Measurement function		
Limit values	Yes	Upper voltage limit
		Upper frequency limit
		Lower frequency limit
Line synchronization	Yes	Off
Quick voltage change (with the frequency unchanged)	Yes	Quick-change enable mode
		QC level A
		QC start phase
		QC time
Voltage variation (with a frequency variation) Transition time	Yes	0.0 s
Precision/high-stability mode	Yes	Precision mode
Remote sensing AGC	No (*2)	
Auto calibration (start)		
External input		

*1: Output is always turned off during the power-on sequence even if the state of output on is stored at memory address 1. In the case of a recall operation that causes a voltage variation (with a frequency variation), if the settings listed below are different before and after the memory recall, output is turned off even if the state of output on is stored in memory.

- The values of the following settings before a memory recall must be the same after the memory recall:
 - Output mode AC/DC  4.2.6 Switching between DC and AC output modes
 - Crest factor function enabled/disabled (If the function is enabled, the CF value must be the same before and after the memory recall.)
 - Line synchronization on/off  4.3.2 Line synchronization
 - Output voltage range 100 V/200 V
 4.2.2 Setting the output voltage and output voltage range
 - Precision/high stability
 4.5.1 Precision and high stability (setting of compensation mode)
- Before and after a memory recall, the quick-change enable mode must not be set
 4.4.1 Quick voltage change (with the frequency unchanged)

*2: These setting states are not subject to the memory storage and recall operations. Switches must be used to specify the settings necessary.

⚠ CAUTION

- If settings for a function available only with an option (ES 4474 remote terminal or ES 4473 interface board) are stored in memory, an unpredictable operation may occur during a recall operation or quick-change operation with the option removed. This is because the contents of memory have been left unchanged.
Before using an option such as the remote terminal after it has been used and removed, restoring the initial state by recalling the contents of address 0 is recommended.
 - When the settings are initialized by recalling the contents of address 0, the settings of functions available only with options (ES 4474 remote terminal and ES 4473 interface board) are initialized as well as the settings listed on the previous page (4-1 Memory storage and initial settings).
Note that the GPIB address and other settings required for use of the ES 4473 interface board are initialized at the same time.
Before using these options, read the ES 4474 Remote Terminal/ES 4473 Interface Board Instruction Manual thoroughly.
-

4.4 Low-frequency Immunity Tests

Low-frequency immunity tests check the robustness (immunity) of the tested unit against a variety of abnormal phenomena that occur on power lines, by generating these phenomena quantitatively.

The tests are also called power supply environment tests for which different rules are defined in the international IEC Standards.

Recently, demand for higher robustness against external abnormalities and noise is increasing, not only in order to comply with regulations on noise generated from equipment, which include radiation noise regulations (FCC, VDE, and VCCI) and harmonics regulations (IEC61000-3-2) but also to improve equipment reliability and safety. Low-frequency immunity tests have become indispensable in efforts to meet this demand.

The device can generate the following abnormal power supply phenomena:

Phenomenon	Description
Quick voltage change (with the frequency unchanged)	Power supply is momentarily interrupted or its voltage decreases or increases momentarily before the original voltage is restored within a certain period. The frequency does not change.
Voltage variation (with a frequency variation)	The power supply voltage and frequency change momentarily or within a certain period. (Either the voltage and frequency change at the same time or only one of them changes.)

CAUTION

- A momentary change in the power supply status is called a “quick change” (QC), such as a quick voltage change and quick frequency change. In contrast, a change made within a certain period is called a “sweep,” such as a voltage sweep and frequency sweep.
The device employs a linear sweep in which values change linearly over time.
The ES 4474 remote terminal and ES 0406 low-frequency immunity test program are provided as options for the device, and they enable simulation of a variety of abnormal power supply phenomena in addition to the phenomena described above.  4.7.5 ES 0406 low-frequency immunity test program
- A quick change and a sweep are performed for three phases at the same time. You cannot set parameters for each phase.

4.4.1 Quick voltage change (with the frequency unchanged)

- The output voltage quick-change function cuts off power, decreases the voltage, or increases the voltage momentarily, and within a certain period, it restores the voltage state set prior to this quick change. You can set only phase L1 (U) as the quick-change start phase. Phases L2 (V) and L3 (W) change at the same time as phase L1 (U) changes.
- Before testing, set a quick-change voltage, quick-change phase, and quick-change time. After setting them, set the quick-change enable mode, and start the test by pressing the quick-change start key. The following figure shows the output observed during such a test:

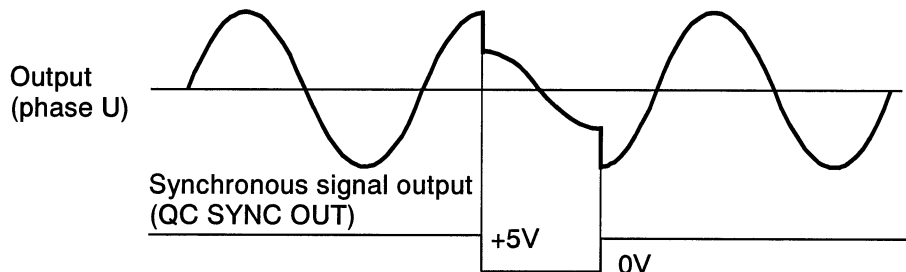

■ Operating procedure: Parameter setting and preparations

Press the **ENBL** key to turn off the lamp and cancel the quick-change enable mode so that quick-change parameters can be set. Each time the **ENBL** key is pressed, the mode is alternately set or canceled.

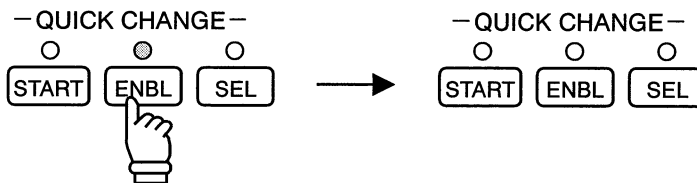

Pressing the **SEL** key displays the currently set values for three parameters: quick-change voltage, quick-change time, and quick-change phase.

In the value displayed, one digit is indicated by the cursor. Each time the **SEL** key is pressed, the cursor moves to the next parameter in the following sequence: quick-change voltage (V) → quick-change phase (deg.) → quick-change time (ms) → quick-change voltage → Move the cursor to the parameter you want to set.

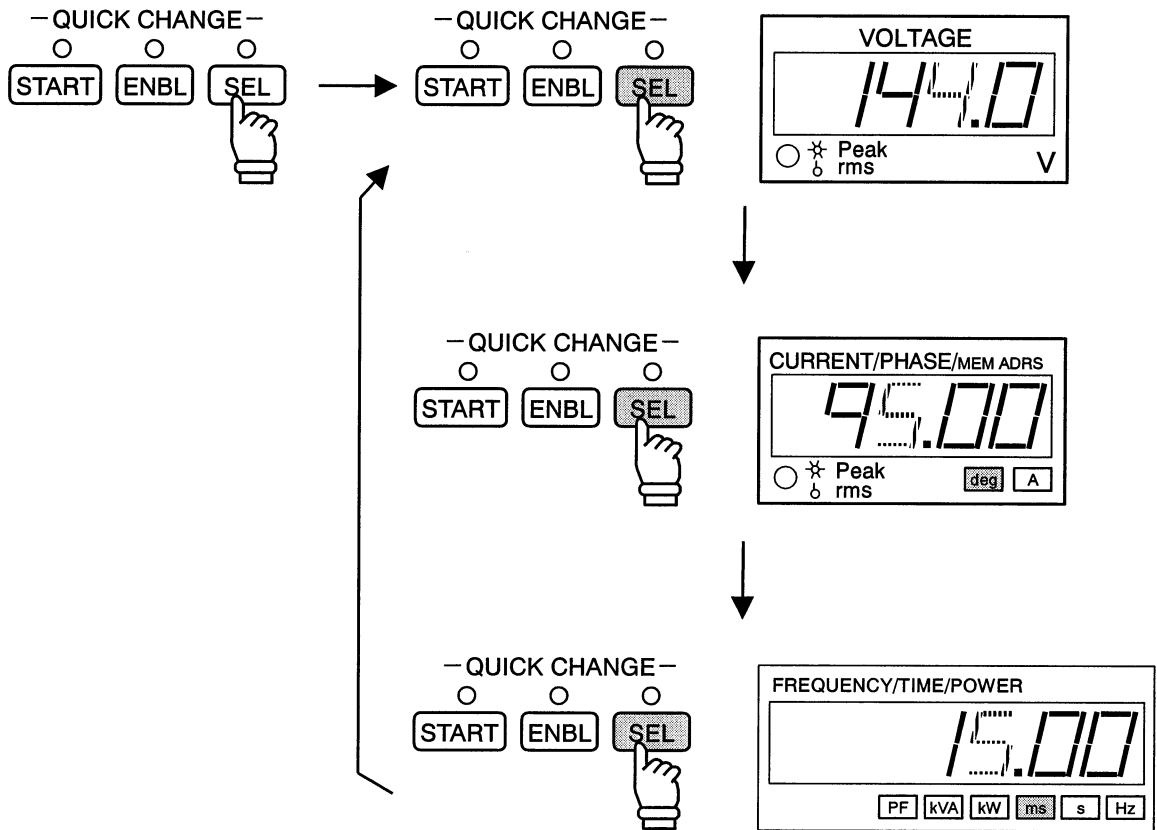

Specify a parameter value by turning the modify dial. You can move the cursor by pressing the ◀ and ▶ keys.

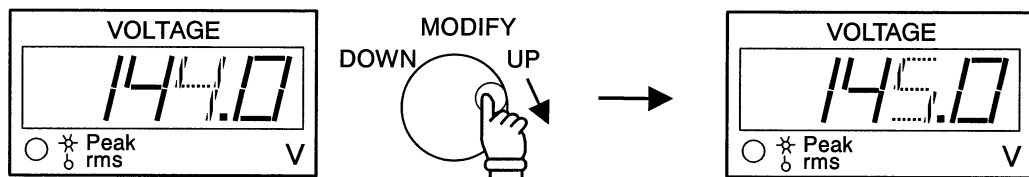

After setting the parameter, press the **ENTER** key. The basic display state prior to the **SEL** key being pressed is restored, and the setting operation ends.

To confirm a set value or to set another parameter value, press the **SEL** key again to enter the setting state.

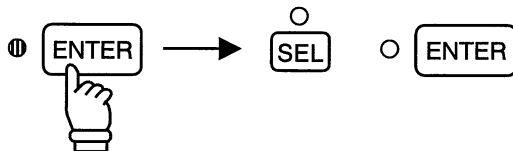

■ **Operating procedure: Performing the test**

After setting parameter values, press the **ENBL** key to set the quick-change enable mode.

The lamp goes on, and the device is ready for the quick-change operation.

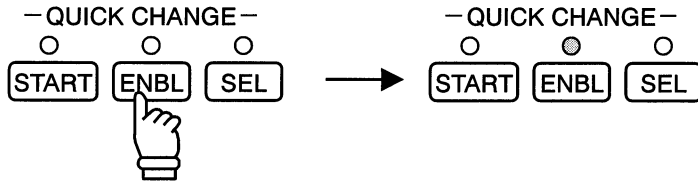

Press the **START** key. The output changes quickly according to the set parameter values.

During the operation, the lamp is on, and after the operation ends, the lamp goes out.

A synchronous signal is output from the QC SYNC OUT terminal at the rear, and it can be used as the trigger signal for the oscilloscope used for observation.

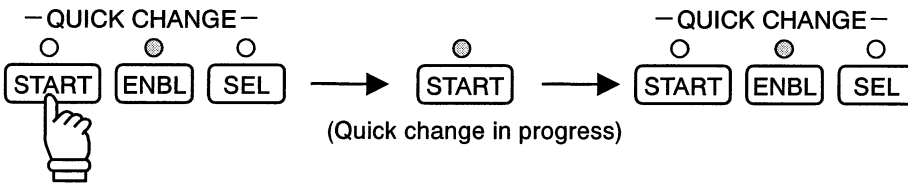

To forcibly stop the quick-change operation in progress and restore the original state, press the **ENBL** key. The original output voltage is restored, and the quick-change enable mode is forcibly canceled.

Even during the operation, output can be turned off by pressing the **OFF/ON** key.

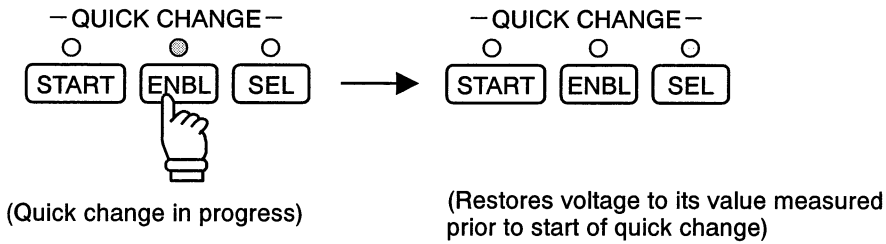

4.4.2 Voltage variation (with a frequency variation)

- The memory function and the transition time setting are used to perform a sweep operation in which the output voltage or frequency changes linearly within the set time. If the transition time is set to 0, a quick-change operation can be performed.  4.3.3 Memory
- Voltage and frequency can be changed independently and at the same time. The following figure shows an example of output during such an operation.

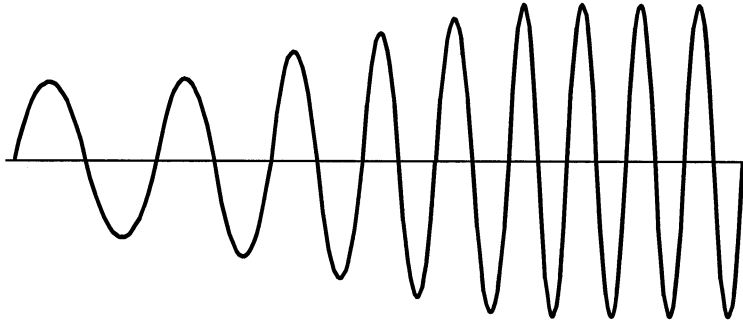

CAUTION

- Unlike a quick voltage change (with the frequency unchanged), this operation can change the frequency but cannot cause a restoration (restoring the value set prior to the quick change).
- More complicated sweep operations (for voltage only) are possible if the optional ES 4474 remote terminal is used, or an external computer connected via the ES 4473 interface board is used for control.

■ Operating procedure: Parameter setting and preparations

Set the output voltage and frequency to the states to be used following a change, and save these states at any memory address.

See the explanation on how to set values in the memory storage operation.

 4.3.3 Memory

Press the  key. The lamp goes on, the set transition time is displayed, and the device enters the setting state.

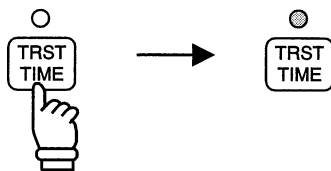

Set the transition time by turning the modify dial. To perform a quick change, set 0. To perform a sweep, set the desired sweep time.

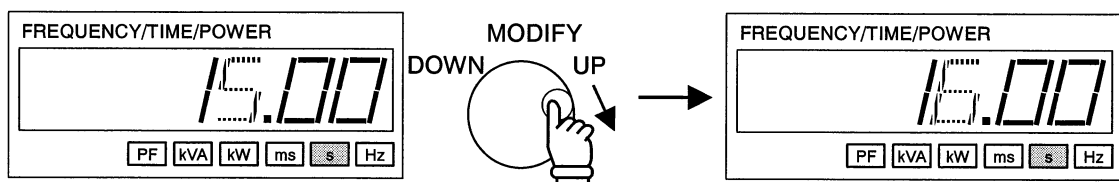

After setting the transition time, press the **ENTER** key. The lamp goes out, and the setting state ends.

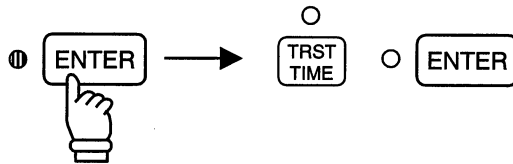

■ Operating procedure: Performing the test

Set the output voltage and frequency to their values set prior to the change, then recall the contents of the address used for the previous memory storage operation.

At the same time as the recall operation, the output starts to change. See the description of the memory recall method. [4.3.3 Memory](#)

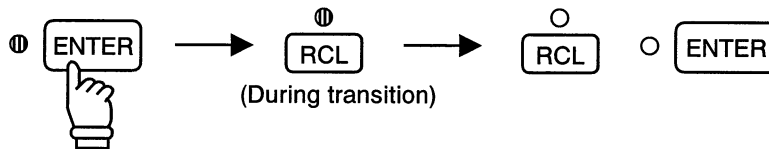

⚠ CAUTION

During a memory recall, the states before and after the memory recall are compared with each other. Then, if the conditions listed below are not met, a quick change takes place instead of a sweep. To enable this operation, settings must be specified so that the following conditions are satisfied:

Conditions for a sweep:

- The following settings must be the same before and after a memory recall:
 - Line synchronization on/off [4.3.2 Line synchronization](#)
 - Output voltage range 100 V/200 V
[4.2.2 Setting the output voltage and output voltage range](#)
 - Output mode AC/DC
 - Crest factor function enabled/disabled (If the function is enabled, the CF value must be the same before and after the memory recall.)
 - Precision/high stability
[4.5.1 Precision and high stability \(setting of compensation mode\)](#)
- Before and after a memory recall, the quick-change enable mode must not be set.
[4.4.1 Quick voltage change \(with the frequency unchanged\)](#)

A quick change and a sweep are performed for three phases at the same time.

A common quick-change phase voltage is set for the phases. You cannot set a line-to-line voltage.

A quick-change phase is set for phase L1 (U). Phases L2 (V) and L3 (W) change at the same time as phase L1(U) changes.

You cannot set parameters for each phase separately.

4.5 Obtaining Precise Output

4.5.1 Precision and high stability (setting of compensation mode)

- This function switches between high and low levels of compensation sensitivity to keep output voltage at a constant level without regard to load current and its variations.
- If high sensitivity (precision mode) is set, the high-precision state can be entered in which variations in output voltage resulted from variations in load current are suppressed. Though a peak current as high as 3.5 times the rated current can be output in this mode, operation to a capacitive load with a large value tends to become unstable. In contrast, if the sensitivity is set to a low level (high-stability mode), variations in output voltage become slightly large, but excellent stability for a capacitive load can be obtained.

■ Operating procedure

Press the **PRCN** key to toggle between the modes. When the lamp is on, the precision mode is set; when off, the high-stability mode is set.

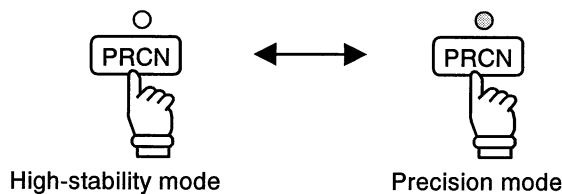

⚠ CAUTION

Stability for capacitive loads:

In precision mode the upper limit of capacitive loads for stable operation is about 20 μF ; in high-stability mode, stable operation is possible for up to about 1000 μF . Depending on the output voltage and frequency settings, however, an overcurrent may flow, resulting in an overload.

4.5.2 Remote sensing AGC (AC output mode)

- The remote sensing AGC function monitors output voltage at an arbitrarily defined position away from the main unit (remote sensing) and provides control to keep the voltage constant (AGC).
It eliminates voltage drops through the output cable and stabilizes the voltage between both ends of a load.
- The rear panel has a terminal for connection and a switch for cabling to the detection point, and the switch is used to set a function. Power must be off when connections are made and when switching is performed.
- You can set this function for each of phases L1 (U), L2 (V), and L3 (W).
- AGC is enabled when output voltage on the output terminal of the device is in a range of 50 V to 300 V.
- When output voltage is changed quickly, the waveform is clipped.
- Load resistance element R, which includes the output cable and capacitance element C, must satisfy the following: $RC = 1500 \mu\text{F} \cdot \Omega$ (where $C = 1000 \mu\text{F} \cdot \Omega$ and the high-stability mode is set)

WARNING

The voltage on the connected terminal is the same as output voltage.
To ensure safety, be sure to turn off power before connecting cables.

CAUTION

- Connect the terminal to the output detection point securely with a twisted-pair cable with a thickness of 0.3 to 1.25 mm². If the connection is broken or the cable becomes damaged during remote sensing AGC, excessive voltage may be generated in the output, leading to possible damage to the load.
In such cases, the overload state is entered, and the generated overvoltage is lowered to about the normal voltage level, but the device cannot be recovered from the overload state until the cause of the abnormality is correct and output is turned off once.  4.2.8 Protection function
- Connect the terminal to the output detection point with the correct polarity.

■ Operating procedure: Performing the test

Connect the detection cable to the SENS terminal. Connect the cable so that the Hi/Lo indication on the SENS terminal matches the indication on the output terminal.

To ensure safety, be sure to turn off power before connecting the cable.

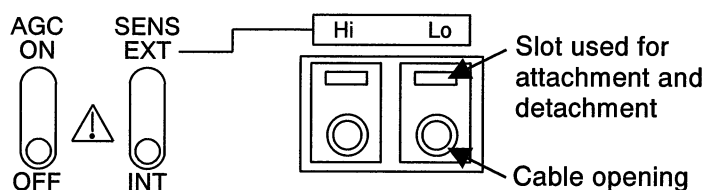

Strip off part of the detection cable jacket. Then, while pressing the attachment/detachment slot with a flathead screwdriver , insert the cable into the cable opening. After inserting the cable, stop pressing with the screwdriver.

Set the SENS INT/EXT switch to EXT.

If remote sensing AGC is not to be used, set the switch to INT.

To ensure safety, set the switch while power is off.

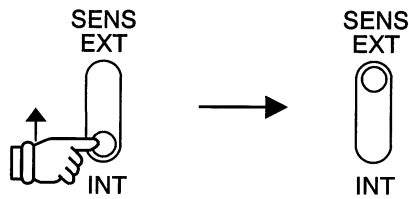

Set the AGC ON/OFF switch to ON. If remote sensing AGC is not to be used, set the switch to OFF. To ensure safety, set the switch while power is off.

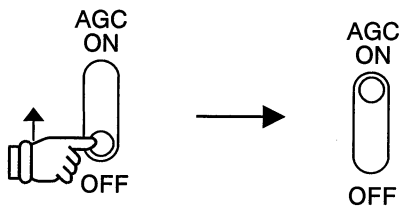

Turn on the device, and confirm that output control works normally.

■ AGC switch and SENS (sensing switching) switch settings

The AGC function detects the average of absolute output voltage values and provides control to compensate for variations in load and maintain stability at high voltages.

Generally, the voltage between the both ends of a load is monitored and used to compensate for any voltage drop through the output cable. (This operation in this device is called “remote sensing AGC.”)

The sensing switch function changes the voltage detection point for AGC and the measurement function between the internal and external points. If EXT is set, and the detection cable is connected to an external detection point, so-called remote sensing is enabled. Therefore, the point can also be used as a measurement point without using AGC.

By combining these two functions, you can choose from the following operations:

Sensing	Measurement value displayed	AGC	
		Off	On
INT	Voltage at internal detection point	No AGC operation (factory set)	Internal detection and AGC operation
EXT (remote sensing)	Voltage at external detection point	No AGC operation	External detection and AGC operation

Note: Read the explanation of terms.  8.1 Glossary

4.5.3 Auto calibration (output voltage calibration function)

This function corrects the difference between the output voltage setting value and measurement value on the basis of the measurement value. As a result, voltage drops through the output cable and decreases in load regulation caused by the load connection can be corrected.

■ Operating procedure

Set output voltage to the required voltage.

☞ 4.2.2 Setting the output voltage and output voltage range

Suppose that the displayed measurement value is several percent lower than the setting value when output is turned on with a load connected to output.

☞ 4.2.4 Turning output on and off, 4.2.7 Measurement function

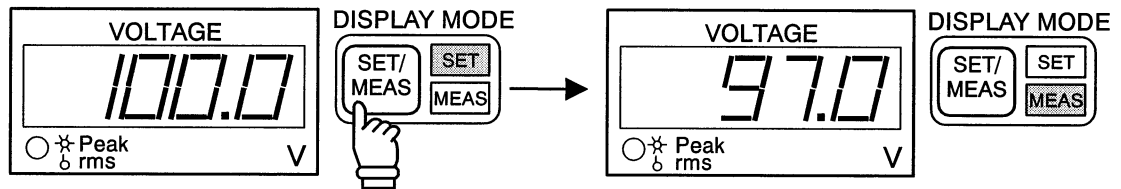

Press the  key. The lamp blinks, and the correction operation starts.

The voltage setting value is compared with the measurement value, and a correction coefficient for adjusting the measurement value to the setting value is obtained.

Note that when the quick-change enable mode is set, the operation cannot be accepted.

☞ 4.4.1 Quick voltage change (with the frequency unchanged)

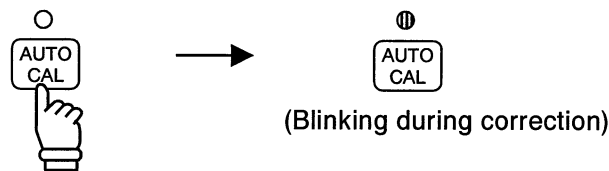

When the correction coefficient is determined, and the setting value is made to match the measurement value, the operation ends, and the lamp goes out. The coefficient is stored in memory supported by an internal backup battery. It is left unchanged until the key is pressed again.

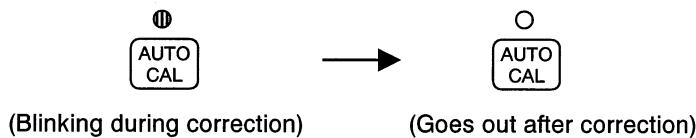

 **CAUTION**

- When the  key is pressed, the correction range is within $\pm 10\%$ of the setting value. If the difference between the setting value and measurement value is extremely large, or if the correction operation cannot end within a certain period, the operation ends with the correction coefficient set to the default value (no correction is made). (A buzzer sounds once when the operation ends.) This tends to occur more frequently if the output voltage value is relatively low (20 V or less).
- When the quick-change enable mode is set, the operation cannot be accepted. Cancel the mode, then make the settings again.

 4.4.1 Quick voltage change (with the frequency unchanged)

4.6 Using External Signals

4.6.1 External input (factory-supplied option)

- When this option is added, the device can be used as an amplifier (with a gain of 100) with an external signal input through a terminal on the rear panel. The input impedance is 100 k Ω (unbalanced), and the input frequency ranges from 5 Hz to 1000 Hz.
- Before using the option, set the maximum value of output voltage.
- When external input mode is set, some functions become unavailable. All settings stored in memory at the time of this mode setting are reset to initial values.

CAUTION

To prevent failures in the device and load resulting from incorrect operation, read this section thoroughly before making settings.

■ Operating procedure: Switch setting on the rear panel

With power turned off, set the SIGNAL INPUT SEL switch on the rear panel to EXT in advance. During the power-on sequence, the system detects the switch setting state and operates in external input mode. All settings stored in memory are reset to initial values. The voltage and frequency are not displayed on the controller.

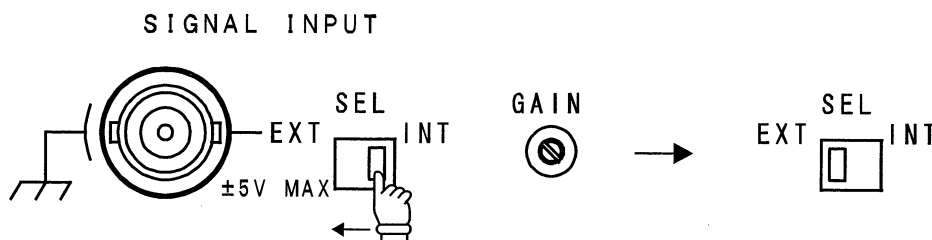

■ Operating procedure: Setting the allowable output voltage

Before inputting a signal, set the maximum value of output voltage. Set the maximum value for each output voltage range.

 4.2.2 Setting the output voltage and output voltage range

Since you cannot set limit values in external input mode, be sure to specify this setting.

 4.3.1 Setting limit values

Press the **ENBL** key to turn off the lamp. Each time the **ENBL** key is pressed, the lamp is alternately turned on or off.

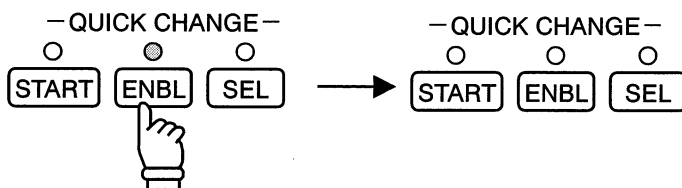

When the **[SEL]** key is pressed, the currently set value of the maximum allowable output voltage is displayed. The displayed voltage is the effective value of the sine wave, and the peak value is $\sqrt{2}$ times the displayed voltage.

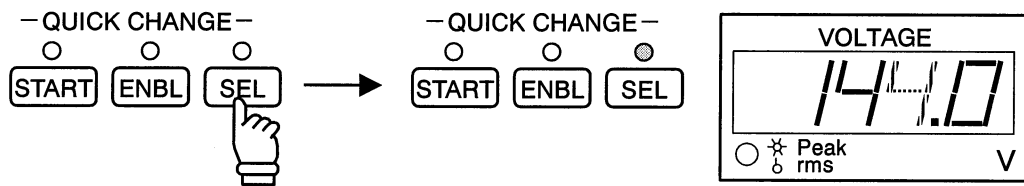

Specify the parameter value by turning the modify dial. The cursor can be moved by pressing the **[◀]** and **[▶]** keys.

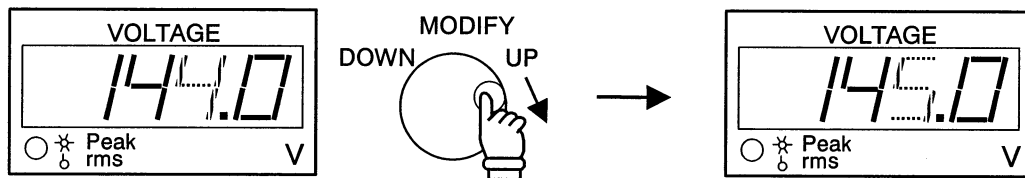

After setting a value, press the **[ENTER]** key. The basic display state prior to the **[SEL]** key being pressed is restored, and the setting operation ends.

To check the set value, press the **[SEL]** key again to enter the setting state.

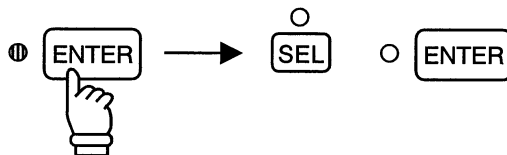

After ending the parameter value setting operation, press the **[ENBL]** key. The lamp goes on, and the previously set voltage is used as the allowable output voltage.

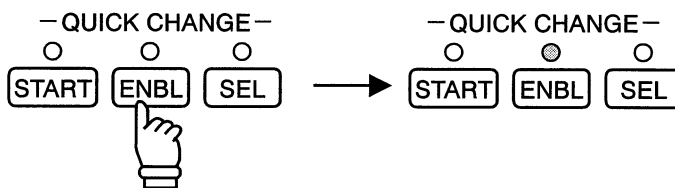

■ Operating procedure: Signal input

When you have performed operations and made settings as described above, preparations for external input are complete. Connect a signal source, and input a signal.









The amplifier gain is 100. Turning the GAIN adjustment changes the gain by $\pm 3\%$. Gain adjustment, however, affects not only external input but also internal signals. Therefore, when you set normal mode again, calibrate with the internal signals before other operations.

6.3 Gain Adjustment

Note that when a signal exceeding the previously set value of allowable output voltage is input, the voltage waveform is clipped at a voltage level as high as $\sqrt{2}$ times the set voltage, and this results in waveform distortion.

To cancel the external input mode, turn off the device, and then set the SIGNAL INPUT SEL switch to INT. When you turn on the device again, it detects the switch setting status and restores operation in normal mode. All settings stored in memory in external input mode are reset to initial values.

CAUTION

- To prevent the output voltage waveform from being clipped, the input voltage must be within ± 4.24 V.
To prevent failures in the input section of the device, be careful not to input voltage exceeding ± 5 V.
 - Note that switching between external input mode and normal mode causes all settings stored in memory to be reset to initial values.
 4.3.3 Memory, 4.3.4 Memory storage and initial settings
 - When using the device in external input mode, the following functions and keys, which can be used in normal mode, cannot be used:
 - Output voltage setting (but the output voltage range can be set).
 4.2.2 Setting the output voltage and output voltage range
 - Output frequency setting  4.2.3 Setting the output frequency
 - Limit values  4.3.1 Setting limit values
 - Low-frequency immunity test  4.4 Low-frequency Immunity Test
 - Auto calibration (output voltage calibration function)
 4.5.3 Auto calibration (output voltage calibration function)
 - Line synchronization  4.3.2 Line synchronization
 - Memory  4.3.3 Memory
 - When using the device in normal mode (with no external input used), set the switch to INT. Even if the switch position is moved while power is on, the operation mode does not change. Be sure to turn off the device before changing the mode, and then make settings again. Although the external conductor of the input signal connector is connected to the housing of the device, it is insulated from output. The DC component of output is suppressed when the device operates. DC input prevents the device from operating normally. Do not input any signal having a DC component. "GAIN" affects not only the external input but also internal signals. When you restore normal mode, calibrate with the internal signal before using the device.  6.3 Gain Adjustment
 - When the external input state is set, it applies to all phases. An internal signal cannot be used for a particular phase.
-

4.7 Introduction of Other Products of the Same Family, Peripherals, and Options

The ES 4439 three-phase/single-phase switching output unit is offered for use with component-type three-phase 6-kVA systems. It enables switching between single-phase mode and three-phase mode. Cabinet-type models are available for large-capacity power supply systems.

The products described below are available as peripherals and options. You can use any of these products to suit your application.

4.7.1 4481 power supply input unit

This unit can receive input power for multiple machines of the component-type model at one time and distribute power to them separately. Up to three units can be connected.

The unit can be used in a system expanded with parallel connections and in a three-phase system.

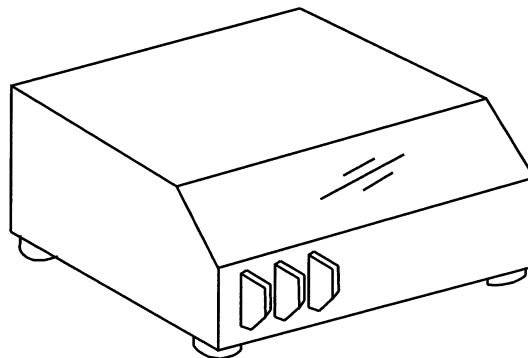

4.7.2 4482 output parallel unit

This unit connects in parallel the outputs of multiple machines of the component-type model and synthesizes the outputs so that power can be supplied from a single terminal block. Up to three units can be connected. Through parallel connection, this unit can be used at system expansion.

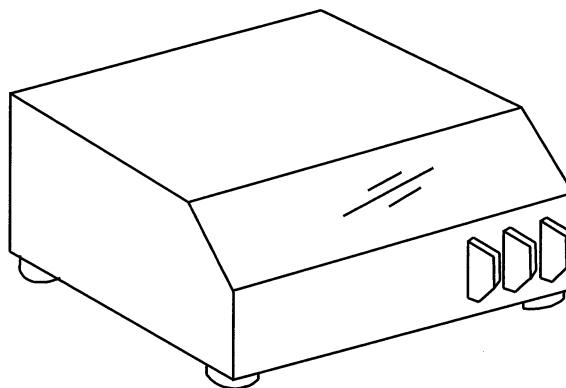

4.7.3 ES 4473 interface board

When connected to the rear panel of the ES 2000U three-phase master, this interface board allows you to control the system from an external computer connected through a GPIB or RS-232 interface. Almost all functions provided by the system can be controlled through this device.

In addition, a connector for signal I/O with an external device is provided to make available the following extended functions:

- VCA (modulation) and ADD (adding superimposition) are performed for output from the main unit by using an external analog signal.
- By using a GPIB or RS-232 interface, 8-bit general-purpose data can be output to an external device.
- Operation status data of the main unit (e.g., output on/off and overload) can be output to an external device.

Using this device together with the ES 0406 low-frequency immunity test program, you can conduct low-frequency immunity tests that comply with immunity standards. (A personal computer having a GPIB interface is necessary to run ES 0406.)

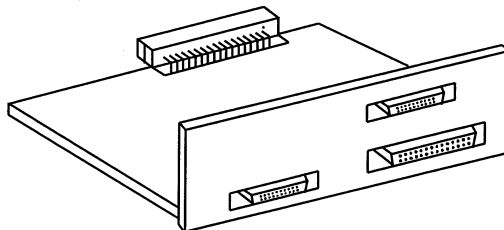

4.7.4 ES 4474 remote terminal

Remote control operations are possible by connecting this remote control terminal to the rear panel of the ES 2000U three-phase master. As a result, the low-frequency immunity test function can be expanded as well as functions provided by the main unit.

 4.4 Low-frequency Immunity Test

For use of this terminal, the ES 4473 interface board is required. If the optical fiber cable unit is also used, such control is possible from a distance of several dozen meters. (For information on optical fiber cable connection, ask our sales staff.)

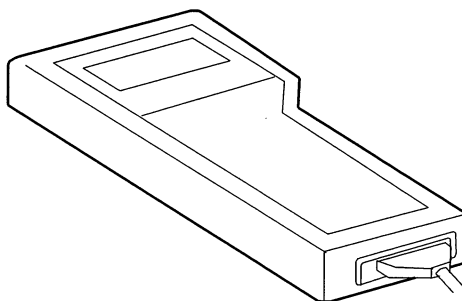

4.7.5 ES 0406 low-frequency immunity test program

Using this program, you can perform a variety of low-frequency immunity tests (power source environment simulations) in addition to the power source environment test functions provided by this device by default.

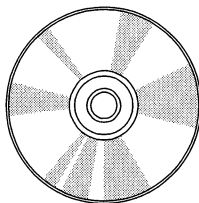

(ES 0406 low-frequency immunity test program)

■ Advanced tests with the use of options

Use of the options allows the following power supply environments to be simulated and the power supply environment test functions provided by the device to be used:

Table 4-2 Supported standard tests

Standard	Test name
IEC 61000-4-11 ^{(*)1} (1994) + A1 (2000)	Voltage dips, short interruptions and voltage variations immunity tests
IEC 61000-4-13 (2002)	Harmonic combination test flat curve
	Harmonic combination test over swing
	Sweep in frequency
	Individual harmonics test
	Interharmonics
Meister curve test	
IEC 61000-4-14 (1999) + A1 (2001)	Voltage fluctuation test
IEC 61000-4-27 ^{(*)2} (2000)	Unbalance test
IEC 61000-4-28 (1999) + A1 (2001)	Variation of power frequency test
IEC 61000-4-29 ^{(*)2} (2000)	Voltage dips, short interruptions and voltage variations on d.c. input power port.
Other tests	Abrupt change in phase and voltage test
	Unbalance in single-phase three-wire systems and three-phase systems test
	Arbitrary waveform test

*1: The As-517 voltage dip simulator manufactured by NF Corporation is required.

*2: With the ES 0406 low-frequency immunity test program, preparatory tests can be performed.

5. Specifications

5.1	Three-phase System	5-1
5.1.1	Output rating.....	5-1
5.1.2	Three-phase AC output	5-1
5.1.3	AC/DC output mode (valid only in single-phase operation).....	5-4
5.1.4	Measurement function.....	5-4
5.1.5	AGC and remote sensing (AC output mode).....	5-6
5.1.6	Auto calibration (AC output voltage calibration function)	5-7
5.1.7	Memory function.....	5-7
5.1.8	Limit value setting.....	5-7
5.1.9	Key lock.....	5-7
5.1.10	Low-frequency immunity tests	5-7
5.1.11	Three-phase/single-phase switching (option dedicated to three-phase 6-kVA systems)	5-9
5.1.12	Interface board (option)	5-9
5.1.13	External signal input (AC output mode: factory-supplied option)	5-10
5.1.14	Power supply input.....	5-10
5.1.15	Other information.....	5-10

5.1 Three-phase System

5.1.1 Output rating

Unless otherwise noted, the following conditions are assumed:

- A rated load (pure resistor load with which the rated power is obtained with the rated output voltage) is connected.
- Output voltage is the voltage on the output terminal of the three-phase master or a three-phase slave.
- AGC is set to off, and remote sensing is set to internal mode.

5.1.2 Three-phase AC output

Configuration	One ES 2000U three-phase master and two ES 2000P three-phase slaves as the basic configuration with N sets of three ES 2000B boosters (N is from 0 to 9.)	
Rated output power ^(*) ⁽²⁾ ⁽⁴⁾	6kVA × (1+N) (6kVA to 60kVA)	
Form	Y connection, 4-wire balanced output (neutral phase grounding possible)	
Terminal	Screw-type (clamp) terminal block	
Output waveform	Sine wave	
Rated output voltage	100-V range	100 Vrms (phase voltage)
	200-V range	200 Vrms (phase voltage)
Output voltage setting range	100-V range	0 to 150 Vrms (phase voltage setting)
	200-V range	0 to 300 Vrms (phase voltage setting)
Output voltage setting resolution	0.1 Vrms (phase voltage)	
Maximum output current ^(*) ⁽²⁾ ⁽⁴⁾	100-V range	20 Arms × (1 + N) (line current) (20 to 200 Arms)
	200-V range	10 Arms × (1 + N) (line current) (10 to 100 Arms)
Maximum output current (Peak value) ⁽³⁾	Precision mode	Up to 3.5 times effective value
	High-stability mode	Up to 2.7 times effective value
Output frequency	Setting range	5 Hz to 1100 Hz
	Setting resolution	0.01 Hz
	Setting accuracy	±1 × 10 ⁻⁴
	Stability	±5 × 10 ⁻⁵
	Power frequency synchronization	Enable (synchronization range 48 Hz to 62 Hz)
Load regulation ⁽⁵⁾	Precision mode	±0.5%
	High-stability mode	±1.0%
Line regulation ⁽⁶⁾	±0.2%	
Output voltage stability ⁽⁷⁾	±100 ppm/°C (typ.) ±100 ppm/8 h (typ.)	
Load power factor range ⁽⁴⁾	0 to 1 (lead or lag)	
Frequency characteristic	±1 db (40 Hz to 1 kHz, rated output voltage)	
Output voltage waveform distortion rate	0.5% or less (rated output voltage)	
Output noise level ⁽⁸⁾	300 mVrms or less	
Output offset voltage	±15 mV (DC)	
Three-phase angle ⁽⁹⁾	120°	
Three-phase angle accuracy	40 Hz to 100 Hz	±1°
	5 Hz to 450 Hz	±2°
	5 Hz to 1000 Hz	±5°

*1: Output current decreases when the rated output voltage is exceeded, as shown in the following figure:

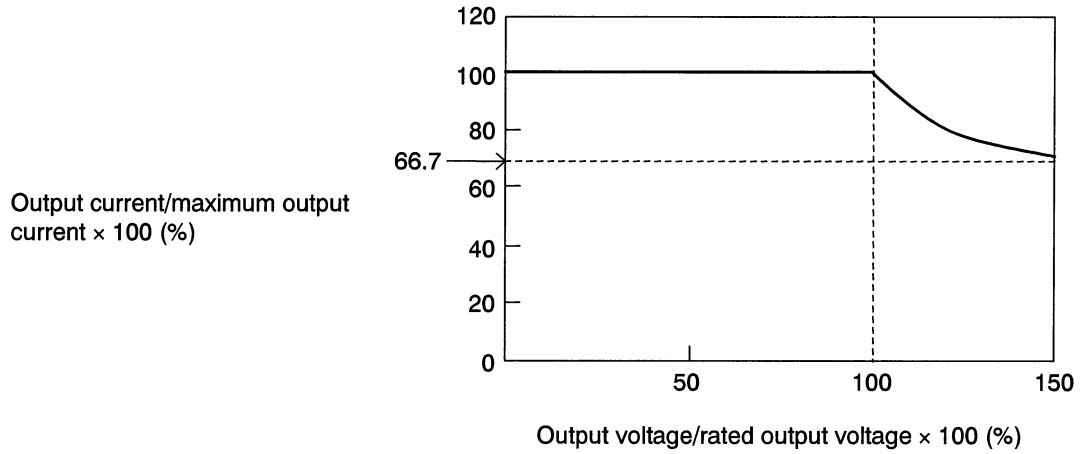

Figure 5-1 Output voltage vs. output current characteristic

*2: Output current decreases depending on the output frequency, as shown in the following figure:

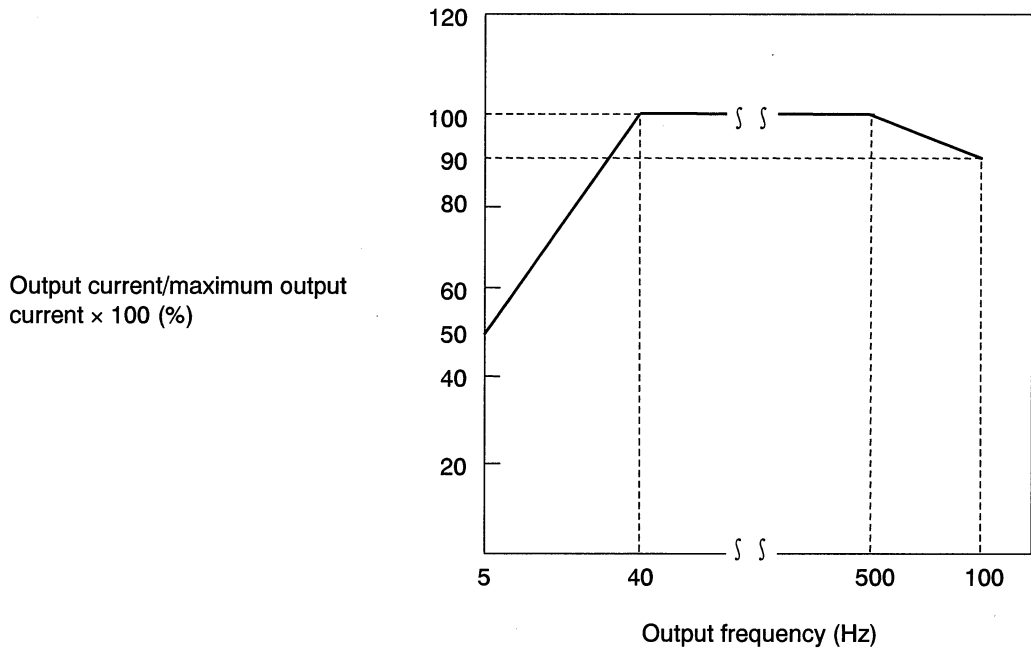

Figure 5-2 Output frequency vs. output current characteristic

*3: Ratio of the peak value of current flowing to a capacitance input-type rectifier load at a range of 45 to 70 Hz to the effective value

*4: Load power factor

PFr is the minimum load power factor allowable for supply of the maximum output current, and it is obtained from output voltage V_o and output frequency f_o as follows:

$$PFr = 7V_o (f_o - 5) \times 10^{-7} + 0.75$$

When output voltage is set with the range as the 200-V range, V_o is 300, and the rms value is 200 Vrms, and when output voltage is set with the range as the 100-V range, V_o is 150, and the rms value is 100 Vrms. PFr is plotted below for the output frequency.

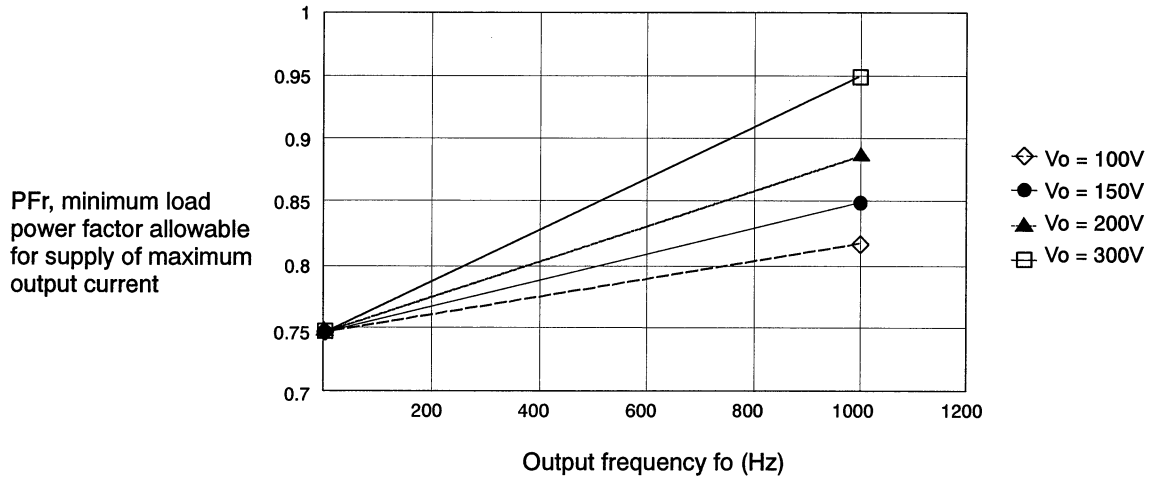

Figure 5-3 Output frequency vs. minimum load power factor allowable for supply of the maximum output current

If the load power factor, PF, is smaller than PFr, the output current that can be supplied decreases for the maximum output current as follows:

$$\text{Output current}/\text{maximum output current} = 93.3 (PF - PFr) + 100 (\%)$$

where output current = Rated value

If PFr is 0.95, 0.85, or 0.75, the output current that can be supplied decreases for the maximum output current as follows:

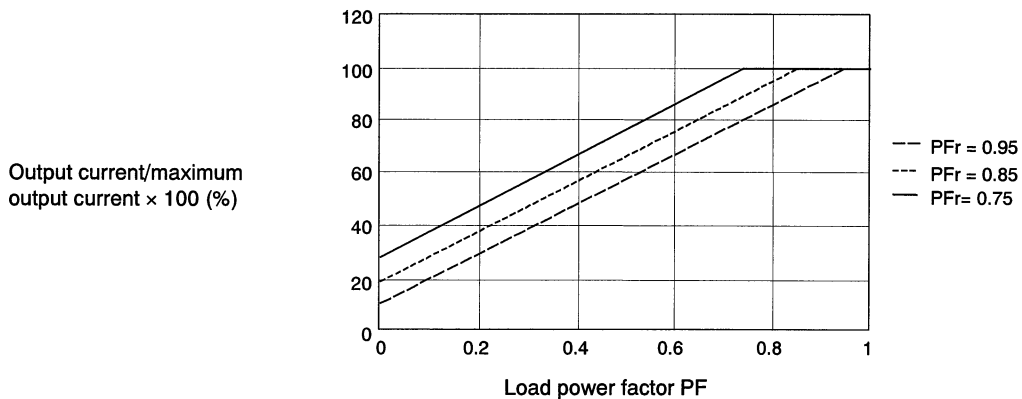

Figure 5-4 Load power factor PF vs. output current

5.1 Three-phase System

The capacitance of a connectable capacitor as the power factor load is restricted to 1000 μF or less when high-stability mode is set and to 20 μF or less when precision mode is set.

The output current is obtained by multiplying output voltage, frequency, and the decrease caused by the load power factor.

- *5: For load changes ranging from 0 to 100% at the rated output voltage.
This is applicable in a range of 45 Hz to 100 Hz. This is the voltage on the main output terminal of the single-phase master, three-phase master, and three-phase slave
- *6: For power supply voltage changes ranging from 170 V to 250 V at the rated output voltage
- *7: Rated output voltage, no load, one hour after power-on
- *8: For output voltage set to 0 V, frequency band of 20 Hz to 100 kHz
- *9: When the angle of phase L1 is 0°, phase L2 has a lag of 120° and phase L3 has a lag of 240°.

5.1.3 AC/DC output mode (valid only in single-phase operation)

This mode is operational for a single-phase system and for a three-phase/single-phase system operating in single-phase output mode.

This mode is unavailable for three-phase systems.

5.1.4 Measurement function

	Measurement range (FS)	Resolution	AC mode accuracy	DC mode accuracy	Measurement conditions
Voltmeter (effective value)	480 V	0.1 V	$\pm 1\% \text{FS}$	$\pm 3\% \text{FS}$	DC, 40 Hz to 1 kHz, 10%FS to 100%FS, including non-sine wave
Ammeter (effective value)	80 A 800 A	0.01 A 0.1 A			
Voltmeter (peak value)	480 V	0.1 V	$\pm 3\% \text{FS}$	$\pm 3\% \text{FS}$	
Ammeter (peak value)	80 A 800 A	0.01 A 0.1 A			
Active power meter	2 kW	0.1 W	$\pm(1.5\% \text{rdg} + 0.2\% \text{FS})$ (at power factor 1)	(Not measured)	45 to 65 Hz, sine waves, voltage of 50 Vrms or more, 10% of rated current or more
	20 kW	1 W			
	200 kW	10 W			
Apparent power and power factor	Displayed after having been calculated based on measurements of voltage, current, and effective power				

FS: Full scale

rdg: Reading

- In a three-phase system, the voltmeter and active power meter specifications apply to displayed values of phase voltage and phase power.
- In a three-phase system, the values of the total apparent power, active power, and power factor of the three phases are obtained through calculations and displayed.
- The measurement ranges of the voltmeter (effective value) and ammeter (effective value) are switched automatically based on the peak value.
- As the peak values of both voltage and current, the waveforms on the negative side are detected in AC output mode, and the waveforms on the positive side are detected in DC output mode (with reference to the output Lo terminal).
- Active power can be measured only in AC output mode.
- The measurement range of active power is automatically changed according to the current peak value.

Measurement range of wattmeter	2 kW		20 kW		200 kW	
Current peak value	0 A	to	7.3 A	to	77 A	to 800 A

- The displayed power value in DC output mode is the apparent power VA calculated based on the effective voltage and current values.

5.1.5 AGC and remote sensing (AC output mode)

Use of the AGC function and sensing switching enables the operations listed below.

In DC output mode, the AGC function does not work regardless of the switch setting.

■ AGC function

This function reduces output voltage variations. Variations in voltage at a sensing point are reduced.

■ Remote sensing AGC (AGC set to on, sensing set to external mode)

If the AGC sensing point is changed to an external point, and voltage on the load terminal is monitored, remote sensing AGC compensates for voltage drops caused by the output cable.

■ Sensing switching

The AGC sensing point, which can also be used as the voltage measurement point of the measurement function, can be switched.

Sensing	Measurement value displayed	AGC	
		Off	On
INT	Voltage at internal detection point.	No AGC operation (factory set)	Internal detection and AGC operation
EXT (Remote sensing)	Voltage at external detection point.	No AGC operation	External detection and AGC operation (Remote sensing AGC)

■ Output rating when remote sensing AGC is used

	Rating	Conditions	
Load regulation	±0.2%	5 Hz to 400 Hz	At sensing input terminal
	±0.3%	400 Hz to 1 kHz	
Frequency characteristic	±0.05 db	40 Hz to 1 kHz	At sensing input terminal, with no load
Voltage waveform distortion rates	0.5% or less	40 Hz to 1 kHz	At rated output voltage on output terminal
	1% or less	5 Hz to 40 Hz	
Response times	50 ms or less	At output voltage of 100 V	
	25 ms or less	At output voltage of 200 V	
Output cable voltage drop Compensation range	Up to 5% of voltage or 10 V, whichever is smaller		

- Output cable resistance R and load capacity C must satisfy the following:
 $RC \leq 1500 [\mu\text{F} \cdot \Omega]$ (where $C \leq 1000 \mu\text{F}$ in high-stability mode)
- Output voltage must be in a range of 50 to 288 V. The load must be a pure resistor.
- When output is changed quickly, the waveform is clipped.

5.1.6 Auto calibration (AC output voltage calibration function)

This function calibrates AC output voltage. The function corrects output voltage so that the output voltage measured by the measurement function (voltage at the sensing point) equals the AC output voltage setting.

Correction range	$\pm 10\%$ (Difference between setting and measurement value)
Correction accuracy	$\pm 1\%$ FS (at 40 Hz to 1 kHz, 50 V or more)

5.1.7 Memory function

This function can store 120 sets of settings specified from the controller except those made with the measurement function (memory addresses 1 to 120). Immediately after power is turned on, the settings stored at memory address 1 are assumed.

When the optional ES 4473 interface board is installed, the GPIB and RS-232 parameters are not stored at the above memory locations but at other locations.

5.1.8 Limit value setting

The upper and lower limits of the output frequency and the upper limit of output voltage can be set. The setting range and setting resolution are the same as those for normal frequency and voltage settings.

5.1.9 Key lock

The key lock switch can be set so as to prevent operations from the controller from being accepted.

5.1.10 Low-frequency immunity tests

Low-frequency immunity tests can be performed with the quick voltage change (with the frequency unchanged) and voltage variation (with a frequency variation) functions.

■ Quick voltage change (with the frequency unchanged) function

Parameters that can be set or controlled

V_{STR} : Start level, T_{Q1} : QC time

V_A : QC level

θ : QC start phase

	Setting range	Setting resolution	Accuracy
QC time	0.1 ms to 6 s	0.1 ms	$\pm(0.2 \text{ ms} + \text{setting value} \times 10^{-4})$
	6 s to 60 s	1 ms	
	60 s to 600 s	10 ms	
QC start phase	0 ° to 360 °	1 °	

The start level and QC level setting ranges must be within the output voltage setting range.

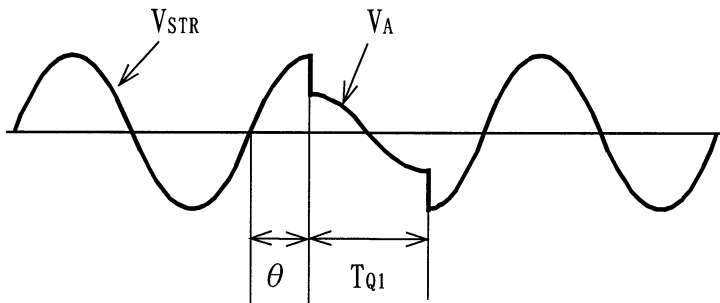

■ Voltage variation (with a frequency variation) function

Parameters that can be set or controlled

During the voltage variation (with a frequency variation)

V_STR: Start level T_A: Transition time f_STR: Start frequency

V_STP: End level f_STP: End frequency

	Setting range	Setting resolution	Accuracy
Transition time	0 to 99.9 s	0.1 s	$\pm 0.1 \text{ s}$

The start level, end level, and start frequency setting range must be within the output voltage setting range.

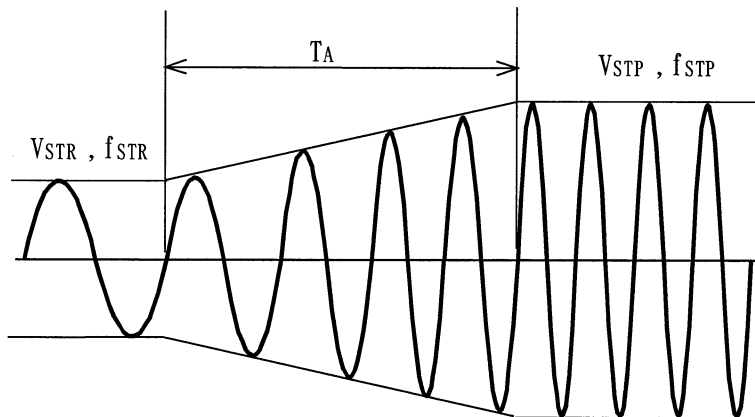

5.1.11 Three-phase/single-phase switching (option dedicated to three-phase 6-kVA systems)

By adding the ES 4439 three-phase/single-phase switching output unit to a three-phase 6-kVA system, switching between single-phase output and three-phase output becomes possible.

5.1.12 Interface board (option)

If the optional ES 4473 interface board is installed, the general-purpose interface bus (GPIB), which is used by most measuring devices, and RS-232 communication interface can be used. Using the board together with the ES 0406 low-frequency immunity test program facilitates low-frequency EMC testing.

In addition, output voltage can have an added analog signal (ADD), and control of the output voltage amplitude (VCA) is possible with the control voltage signal.

■ General-purpose interface

Select and use one of the following interfaces:

- GPIB: IEEE-STD-488.1-1987 compliant
- RS-232: JIS-C-6361 compliant

■ External analog control input

Addition input (ADD)

Input impedance	20 k Ω , unbalanced
Addition frequency range	10 Hz to 1 kHz
Addition sensitivity	10%/V
Polarity	I/O in phase
Input terminal	CONTROL SIGNAL connector (D-sub) on rear panel

Amplitude modulation input (VCA)

Input impedance	20 k Ω , unbalanced
Modulation frequency range	DC to 100 Hz
Modulation sensitivity	10%/V
Polarity	Output voltage is increased by positive input increases and decreased by negative input.
Input terminal	CONTROL SIGNAL connector (D-sub) on rear panel

5.1.13 External signal input (AC output mode: factory-supplied option)

If this option is specified, the following external signal can be input in AC output mode:

Input impedance	100 k Ω (unbalanced)
Input frequency range	5 Hz to 1 kHz
Maximum input voltage	± 5 V
Gain	100
Terminal	BNC connector on rear panel
Switching method	After the switch on the rear panel is set to EXT, the switch setting becomes valid only when power is turned on.

5.1.14 Power supply input

Voltage range	Single-phase, 170 Vrms to 250 Vrms
Frequency range	48 Hz to 62 Hz
Power consumption	Approx. 3800 VA at rated output This is the power consumption of a single ES 2000U three-phase master, ES 2000P three-phase slave, or ES 2000B booster unit. The power consumption of the entire system is obtained by multiplying this value by the total number of units in the system.
Power factor	0.9 or more (0.97 typ. at rated output)
Terminal	2P terminal block (with M4 screw) Note: Protective ground terminal provided

5.1.15 Other information

■ Temperature and humidity ranges

Guaranteed performance	+5 to +35°C	5% to 80%RH, where absolute humidity is 1 to 25 g/m ³ . No condensation.
Guaranteed operation	0 to +40°C	5% to 80%RH, where absolute humidity is 1 to 25 g/m ³ . No condensation.
Storage conditions	-10 to +50°C	5% to 95%RH, where absolute humidity is 1 to 29 g/m ³ . No condensation.

■ Insulation resistance

10 M Ω or more (500 VDC): Chassis and all power supply inputs to output, and chassis and all outputs to power supply input
This is the insulation resistance value of a single ES 2000U three-phase master, ES 2000P three-phase slave, or ES 2000B booster unit.
When multiple units are connected in parallel and used, divide the value by the number of units.

■ Withstand voltage

AC 1500 Vrms for one minute (50/60 Hz): Chassis and all power supply inputs to output, and chassis and all outputs to power supply input

■ External dimensions

(width) 238 mm × (height) 702 mm × (depth) 800 mm (protrusions included)

■ Weight

Approx. 48 kg: Weight of one ES 2000U three-phase master, ES 2000P three-phase slave, or ES 2000B booster unit

■ Installation

Install the device at a location that satisfies the following conditions:

- Indoor area not exposed to direct sunlight
- Environment whose temperature and humidity are within the rated values
Note: There must be no condensation.
- Area with little dust.
- Place at which corrosive, explosive, or flammable gas is not present
- Place at which the device not likely to come in contact with fire or water
- Area with enough space so that the front and rear of the device are at least 50 cm apart from walls and other objects that could obstruct the vents and reduce the effect of cooling air (This system uses a fan for forced air cooling. If air flow is obstructed, the device can therefore not be used within the temperature range of guaranteed operation.)

■ Standard data

Output voltage (50 Hz, 0 dB)

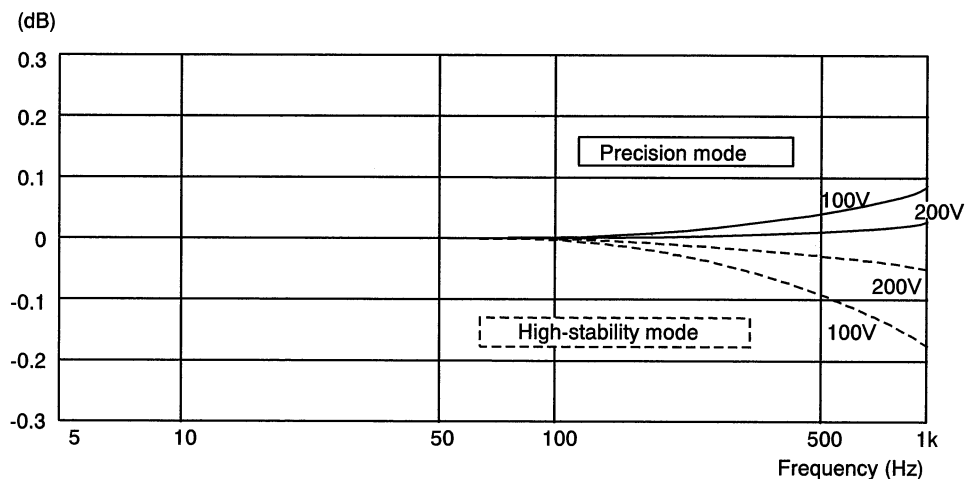

100 V denotes the 100-V range, and 200 V denotes the 200-V range.
SIG SELECT is set to INT, with a rated load.

Figure 5-5 Output voltage vs. frequency characteristic

5.1 Three-phase System

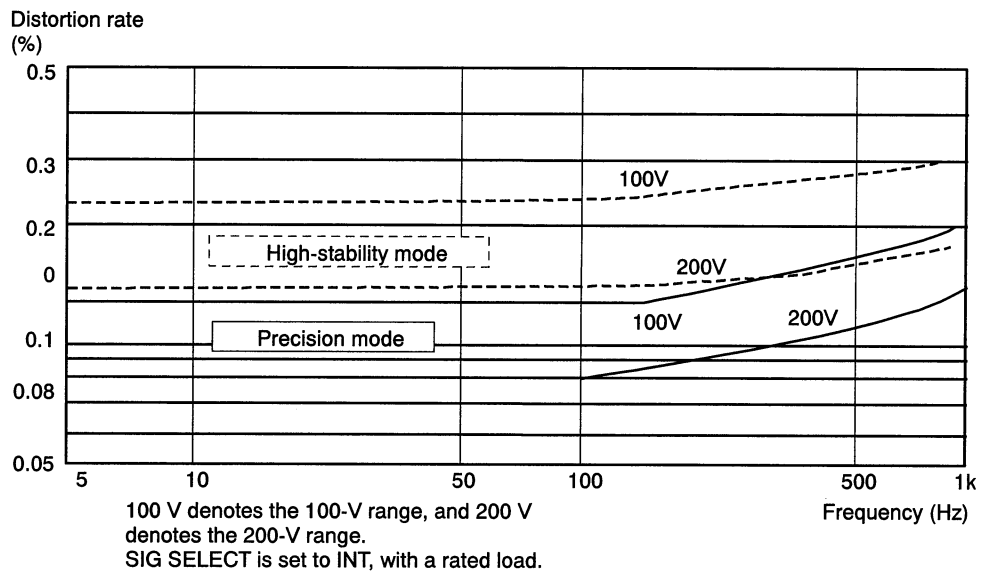

Figure 5-6 Total harmonic distortion rate vs. frequency characteristic

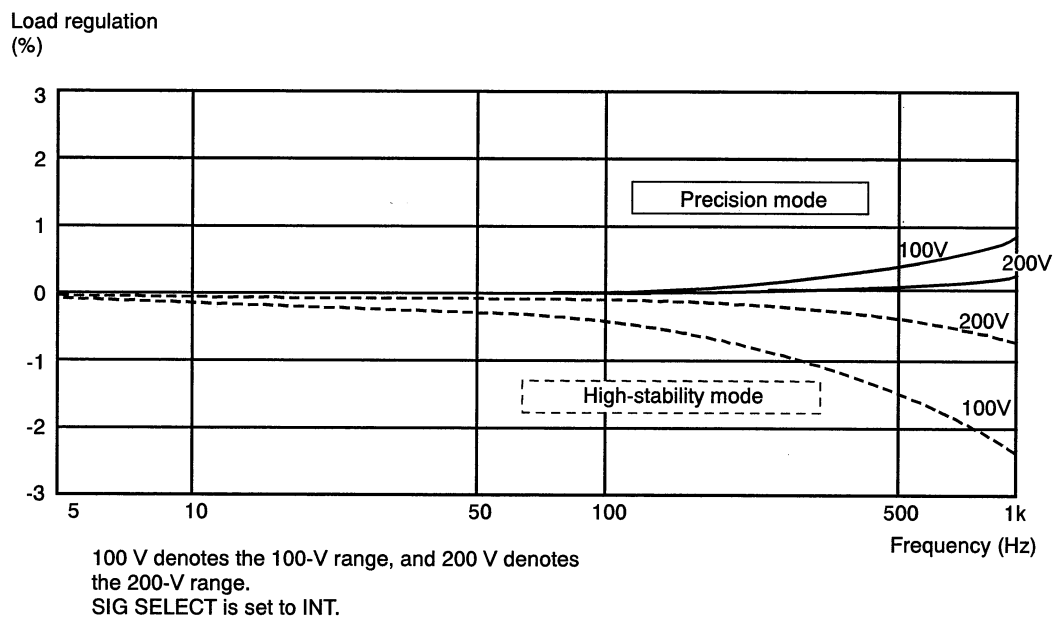

Figure 5-7 Load regulation vs. frequency characteristic

6. Maintenance

6.1	Cleaning the Air Filter	6-1
6.2	Backup Battery	6-2
6.3	Gain Adjustment	6-3
6.4	Operation Checks	6-4
6.4.1	Check method	6-4

6.1 Cleaning the Air Filter

Dust that enters and sticks to the device absorbs water from air, possibly leading to the rusting of metal inside and degraded insulation performance. These effects may have negative consequences on the high-voltage parts inside the device.

For this reason, the intake vent in the front section is equipped with an air filter to remove dust from air flowing through the vent.

If dirt sticking to the filter is not removed, the filter becomes clogged, which causes poor ventilation and results in a higher internal temperature, which can cause reliability to deteriorate.

Therefore, clean the filter carefully with water to remove dirt. Before installing the filter again, allow the filter to dry completely.

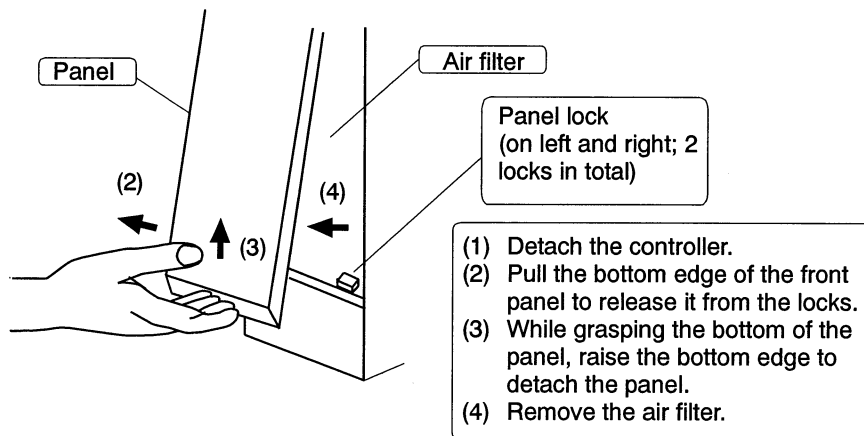

Figure 6-1 Detaching the air filter

The filter alone, however, does not have an adequate effect, because its reliability deteriorates from very fine dust (impalpable powder) in the air, and when the filter becomes clogged. Therefore, it is strongly suggested that the device be installed at a place that does not have a significant amount of dust (including impalpable powder), a high level of humidity in which condensation forms easily, or corrosive, explosive, or flammable gas.

6.2 Backup Battery

The contents of memory (☞ 4.3.3 Memory) and other necessary parameters and data are protected with a vanadium-lithium (VL) secondary battery included in the ES 2000U three-phase master.

The battery is completely discharged immediately at the time of shipment from the factory. It is fully charged after the device has been powered for 50 hours.

After that, the battery can be kept fully charged if the device is powered for at least 20 hours per week.

When the battery is fully charged, it can provide backup power to the internal storage device for about 60 days, but this period varies from battery to battery and depends on the ambient temperature.

A degraded battery can serve as a backup power source for a shorter period, but if the battery can no longer serve this function for practical length of time, NF Corporation will replace it. Contact us or one of our agents.

If the device is stored for six months or longer without receiving power, the battery service life is shortened. Therefore, it is recommended that the device be turned on occasionally.

Each time the device is turned on, it checks the consistency of the backup data. If any part of the backup data is destroyed, the device displays an error message (☞ 7.1 Error Messages) and resets all the data to the default state. (☞ 4.3.4 Memory storage and initial settings)

6.3 Gain Adjustment

The voltage gain of the internal power amplifier can be adjusted from the rear panels of the ES 2000U three-phase master and ES 2000P three-phase slave. [☞ 2.1.3 Rear panel](#)

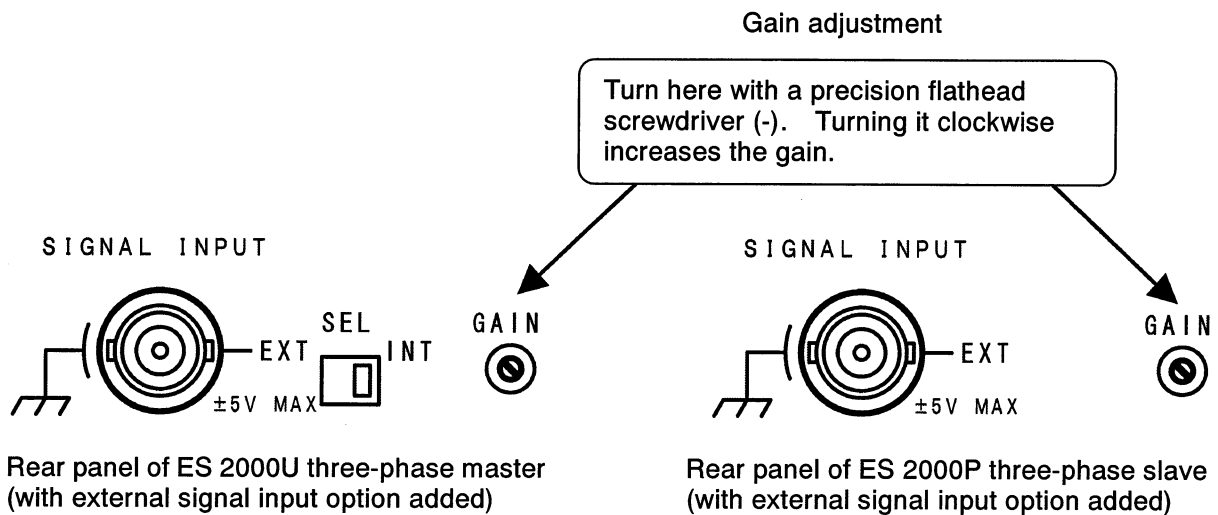

This section describes how to adjust the gain of the internal amplifier by using the measurement function of this device. To adjust the gain, follow the procedure below.

- (1) If the external signal input option has been added, cancel external input. Set the SEL switch to INT.
- (2) Turn on the device. Set the output voltage range to 200 V and output voltage to 0 V. Output must not be turned on.
- (3) Press the **AUTO CAL** key. The system performs auto calibration, which ends with the sounding of a buzzer.
(This operation resets the correction constant stored in internal memory.)
- (4) Set output voltage to 300.0 V. Output must not be turned on.
- (5) Press the **SET/MEAS** key to set the display mode to the mode for displaying measurement values.
- (6) Press the **U/V/W** key, which displays the phase voltage of each phase sequentially, and set the gain adjustment so that 300.0 V is displayed as the voltage measurement for each of the master and slaves.

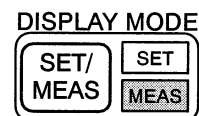

When the auto calibration function is used, output voltage is automatically corrected by the measurement function of the device, so the adjustment procedure described here is not normally required. [☞ 4.5.3 Auto calibration \(output voltage calibration function\)](#)

However, this adjustment mechanism affects both signals from the internal signal generator and signals input externally. When the normal internal signal mode is restored with external input after gain is adjusted, a re-adjustment operation is required.

[☞ 4.6.1 External input \(factory-supplied option\)](#)

6.4 Operation Checks

Using the methods of checking operation explained in this section, users can easily check operation without opening the device.

Check operation when the ES 2000U three-phase master, ES 2000P slaves, and ES 2000B boosters are all connected.

For a load test, a power resistor having a capacity corresponding to the maximum power supplied by the system must be used as the load. If preparing such a load is too difficult, perform only a no-load test. This can check basic operation of the device.

In cases where each unit must be inspected separately, where load tests are required, or where an inspection shows the necessity of calibration or repair, contact us or one of our agents.

If you do not understand an operation, see detailed operation information on the page indicated by the relevant  reference.

6.4.1 Check method





Connect the ES 2000U three-phase master, ES 2000P three-phase slaves, and ES 2000B boosters in the system configuration that you generally use.

 3.4 Connection Method for the Three-phase System with the Basic Configuration (Three-phase Master and Three-phase Slaves)

■ Necessary instruments

- AC voltmeter, AC ammeter: 2014 (YOKOGAWA ELECTRIC) or equivalent
Note: Voltage and current are measured in the range from 50 Hz to 60 Hz.
- Oscilloscope: 2445B (Tektronix) or equivalent
Note: With a bandwidth of approximately 100 MHz and a cursor measurement function, observe the phase shift between phases in the range from 50 Hz to 60 Hz.

■ Settings for checks

- If external input mode is set, change the mode to the internal mode.
 4.6.1 External input (factory-supplied option)
- Turn off the AGC function, and set sensing to internal sensing. (Cancel remote sensing AGC.)
 4.5.2 Remote sensing AGC (AC output mode)
- Set the output frequency to 50 Hz or 60 Hz.
 4.2.3 Setting the output frequency
- Set the compensation mode to precision mode.
 4.5.1 Precision and high stability (setting of compensation mode)
- Cancel the quick-change enable mode.
 4.4.1 Quick voltage change (with the frequency unchanged)

■ Check method

- Before connecting a load or measuring instrument to output, turn off output.
☞ 4.2.4 Turning output on and off
- Set output voltage to 100 V.
☞ 4.2.2 Setting the output voltage and output voltage range
- The system performs auto calibration.
☞ 4.5.3 Auto calibration (output voltage calibration function)
- Using the measurement function, measure the output voltage for each phase, and check to confirm that each measurement value is within $\pm 0.3\%$ (standard value) of the setting value.
☞ 4.2.7 Measurement function
- Set output voltage to 200 V, and repeat the steps for checking.
- Use the neutral phase as a reference, and observe the voltage of each of phases L (U) (three-phase master), L2 (V) (three-phase slave), and L3 (W) (three-phase slave) by using an oscilloscope. With the waveform of phase L1 (U) as the base for comparison, confirm that the waveform of phase L2 (V) has a lag of 120° and the waveform of phase L3 (W) has a lag of 240° (which indicates that the three phases are balanced).

7. Troubleshooting

7.1	Error Messages	7-1
7.2	When an Error Seems to Have Occurred	7-2

7.1 Error Messages

When turned on, this device checks system connections and the system configuration. If an abnormality is found, the device indicates an error on the controller. The value displayed following the “ERR” indication denotes the error.

Descriptions of errors, and the device response, and the appropriate action that users should take for each error indicated are listed below.

Not every indicated error leads to a serious problem if left as is. However, if an error is indicated, turn off power to the device and check the relevant parts individually.

Example of indicated error

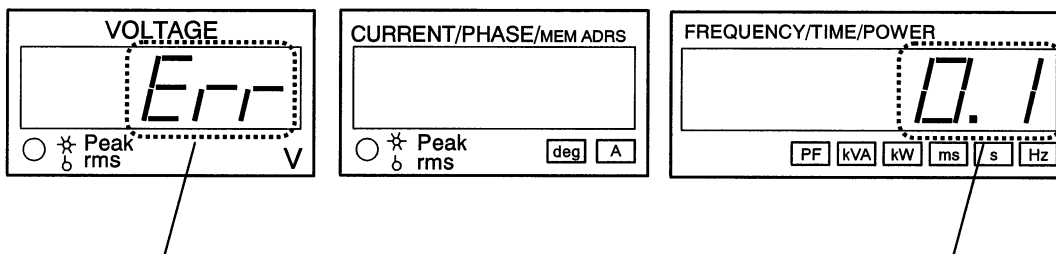

Indicates that an error occurred (Err).

Indicates the type of error that occurred.
(See the table below.)

Error indication	Cause	Necessary response or explanation
	Contents of internal ROM were destroyed.	A component may be defective. Check the indicated error, and contact us or one of our agents.
	An internal RAM operation check found an error.	Operation stops when this is displayed, and it remains displayed until the device is turned off.
	Part or all of data in memory supported by the internal backup battery was lost.	If this error occurs, the error is indicated for 2 seconds before all stored data is reset to default values and normal operation starts. ☞ 4.3.4 Memory storage and initial settings This error may occur when the device has remained powered off for a long time. If this error occurs frequently, the battery characteristic of the backup battery may have deteriorated. ☞ 6.2 Backup Battery
	Is power being supplied to both connected three-phase slaves?	Turn off the master, turn on the power switch of both two three-phase slaves, and then turn on the master on again. If this remains displayed after the above operation, a failure may have occurred in the internal signal transfer path. Check the indicated error, and contact us or one of our agents.

7.2 When an Error Seems to Have Occurred



If you believe an error occurred during use of the device, see the table below to check whether the observed device behavior is really an error and whether the operating procedure, method of use, and cable connections are correct.

If your situation is not covered by the descriptions below, there could be danger from a secondary failure if a failure did occur. In such cases, contact us or one of our agents, and do not turn on the device.





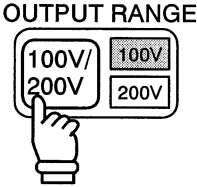
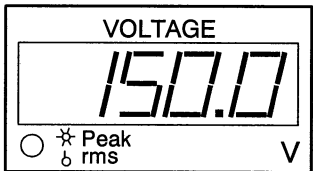





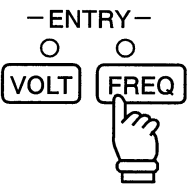



■ Behavior observed during power-on or power-off

Behavior	Cause or condition	Appropriate action and explanation
When the power switch is turned off during operation, the pilot lamp blinks, and the device does not stop operating immediately. About five seconds afterward, the lamp goes out, and operation stops.	The relevant capacitor in an internal circuit has a large capacitance and is being discharged. The blinking lamp indicates that this discharging is in progress.	This is not abnormal. Before turning on the switch to power on again, wait until the lamp stops blinking.
When the power switch is turned on, the pilot lamp blinks, but operation does not start.	The relevant capacitor in an internal circuit has a large capacitance and is being discharged. The blinking lamp indicates that this discharging is in progress.	Turn off the switch, wait until the lamp stops blinking, and then turn on the switch again to power on.
Turning on the power switch does not start operation at all.	Is power definitely being supplied?	Check whether power is definitely being supplied.
	Are the cords connecting the master to each slave, the master to each booster, and each slave to each booster securely attached?	Check whether power is definitely being supplied.

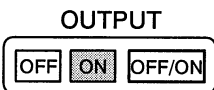

■ Behavior related to the output voltage setting and voltage range setting

Behavior	Cause or condition	Appropriate action and explanation
The voltage range cannot be changed from 200 V to 100 V. 	Does output voltage or the QC voltage setting exceed 150 V?	Set them to 150 V or less. 
Output voltage cannot be set.	Is external input set?	Cancel external input, and set normal mode.  4.6.1 External input (factory-supplied option)

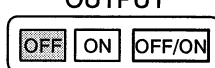
■ Behavior related to frequency settings

Behavior	Cause or condition	Appropriate action and explanation
<p>The output frequency cannot be set.</p> 	<p>Is line synchronization turned on?</p> 	<p>Before setting it, turn off line synchronization.  4.3.2 Line synchronization</p> 
	<p>Is external input set?</p> <p>SIGNAL INPUT</p> 	<p>Cancel external input, and set normal mode.  4.6.1 External input (factory-supplied option)</p> 
<p>Line synchronization cannot be set.</p> 	<p>Is the upper frequency limit value less than 55 Hz, and is the lower limit value greater than 55 Hz?</p> <p>— LIMIT —</p> 	<p>Set the upper and lower frequency limits so they define a range that includes 55 Hz. (Set the upper limit to 55 Hz or higher and the lower limit to 55 Hz or lower.)  4.3.1 Setting limit values</p>
	<p>Is external input set?</p>	<p>Cancel external input, and set normal mode.  4.6.1 External input (factory-supplied option)</p>
<p>Line synchronization cannot be set. Alternatively, line synchronization cannot be canceled.</p> 	<p>Is output set to on?</p> 	<p>Setting and cancellation cannot be possible unless output is turned off.  4.2.4 Turning output on and off</p> 



■ Behavior related to overload (☞ 4.2.8 Protection function)

Behavior	Cause or condition	Appropriate action and explanation
The overload lamp goes on. 	Has the overload state been entered?	Check the load, and use the load within the relevant rating.
	Has the device been turned off?	This is not abnormal.
	Has the device been turned on?	If the lamp is on for a short time, this is not abnormal.
	Output voltage increased suddenly.	
	Output was turned on.	
	A QC operation started or ended.	
	The voltage range was changed.	Was the output voltage waveform clipped because of an excessive input signal? Check whether the input signal value is appropriate. Confirm that values are 2.88 Vrms and 4.07 Vp or less.
	This occurs at the time of external input.	
	Is the AGC switch set to on? 	Confirm that the compensation range (up to 5% of output voltage or 10 V, whichever is smaller) has been exceeded.
Is the SENS switch set to EXT? 	Confirm that the sensing cable is securely and correctly connected.	

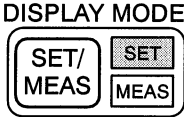
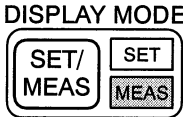
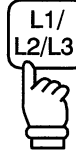
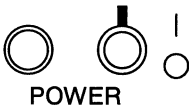



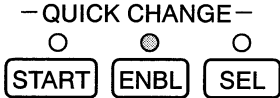

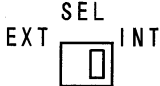



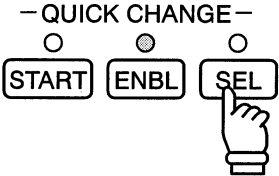

■ Behavior related to the measurement function

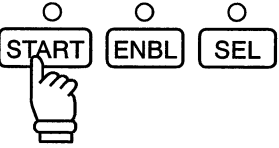
Behavior	Cause or condition	Appropriate action and explanation
Switching between the effective value and peak value is not possible. 	Is DISPLAY MODE set to SET? 	Before attempting switching, set MEAS. ☞ 4.2.7 Measurement function 
Measurement phase switching for MEASURE is not possible. 	Is power being supplied to both three-phase slaves? 	Turn off the master, turn on the power switches of both three-phase slaves, and then turn on the master again.

■ Behavior related to auto calibration

Behavior	Cause or condition	Appropriate action and explanation
Auto calibration cannot be performed. 	Is the frequency less than 40 Hz?	Set the frequency to 40 Hz or higher so that auto calibration can be performed.
	Is the quick-change enable mode set? 	Cancel the enable mode so that auto calibration can be performed. ☞ 4.4.1 Quick voltage change (with the frequency unchanged)
	Is external input set? 	Cancel external input, and set normal mode. ☞ 4.6.1 External input (factory-supplied option) 

■ Behavior related to quick voltage changes (QC: Quick change) [1]

Behavior	Cause or condition	Appropriate action and explanation
<p>Operations with the quick-change parameter setting key cannot be accepted.</p> <p>— QUICK CHANGE —</p> 	<p>Is the quick-change enable mode set?</p> 	<p>Before attempting this operation, cancel the enable mode.</p> <p> 4.4.1 Quick voltage change (with the frequency unchanged)</p> 
<p>A quick change cannot start.</p> <p>— QUICK CHANGE —</p> 	<p>Is the quick-change enable mode set?</p> 	<p>The operation cannot start unless the enable mode is set.</p> <p> 4.4.1 Quick voltage change (with the frequency unchanged)</p> 
<p>After a quick change starts, the change is made more than once.</p>	<p>Have you performed the operations made necessary because the ES 4474 remote terminal or ES 4473 interface board was connected? If either of these options was used, its corresponding mode may be set. Consequently, a setting defined during a previous operation may remain.</p> <p> 4.7.4 ES 4474 remote terminal</p> <p> 4.7.3 ES 4473 interface board</p>	<p>To interrupt execution, cancel the enable mode while the operation is in progress.</p> <p>Also, re-connect the aforementioned option to check the settings, or recall values from memory address 0, reset all settings to their initial states, and specify settings again.</p> <p> 4.4.1 Quick voltage change (with the frequency unchanged)</p> <p> 4.7.3 ES 4473 interface board, 4.7.4 ES 4474 remote terminal</p> <p> 4.3.3 Memory</p>

■ Behavior related to quick voltage changes (QC: Quick change) [2]

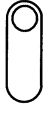
Behavior	Cause or condition	Appropriate action and explanation
When a quick change is made to increase voltage, a distortion was observed in the output voltage waveform immediately after the start of the quick change.	The quick change started immediately after the quick-change enable mode was set,	Set the enable mode, wait 1 to 2 seconds, and then start the operation. ☞ 4.4.1 Quick voltage change (with the frequency unchanged)
	Is the AGC switch set to ON? 	For a quick voltage change, turn off the switch so that the AGC function is not used. ☞ 4.5.2 Remote sensing AGC (AC output mode)

■ Other unusual behavior

Behavior	Cause or condition	Appropriate action and explanation
When external input is used, a sudden increase in the signal level from 0 V causes distortion of the output voltage waveform for a short time.	Is the allowable output voltage set?	Set the allowable output voltage. ☞ 4.6.1 External input (factory-supplied option)
	Is the AGC switch set to ON? 	Turn off the switch so that the AGC function is not used. ☞ 4.5.2 Remote sensing AGC (AC output mode)

8. Supplementary Information

8.1 Glossary.....	8-1
-------------------	-----

8.1 Glossary

Term	Description
<p>AC power supply AC regulator</p>	<p>Although commercial AC power supplies are widely used in a variety of devices that receive power fed through distribution panels and wall outlets via substations from electric power companies' power plants, AC voltages and waveforms from these power supplies are distorted by the effect of the impedances and loads of feeders.</p> <p>At the same time, demand for improved reliability in such commercial power supplies is growing as the quantification of electronic devices and their precision increases.</p> <p>One solution to this problem is to regulate power at the receiving end. The conventional methods are use of a saturable reactor and servo-control of a slide regulator. However, these methods have two significant disadvantages: slow response speeds and waveforms that cannot be improved. Both methods are no longer considered practical. Other methods using electronic circuits are being devised and implemented.</p> <p>This device uses the power amplifier method. By using a built-in signal generator, the device can supply stable AC voltage with low distortion, and it can generate a variety of abnormal phenomena that may occur on commercial power lines so that the effect of loads can be simulated for low-frequency immunity tests.</p>
<p>Low-frequency immunity test</p>	<p>A variety of abnormal phenomena that occur on commercial power lines can be generated quantitatively to test the robustness of the tested unit against the phenomena.</p> <p>Robustness against external abnormalities and noise is tested in order to improve device reliability and safety rather than determine compliance with conventional regulations on noise generated from devices. Examples of such regulations are regulations on radiation noise in conductors (CISPR, FCC, VDE, and VCCI) and harmonics regulations (IEC61000-3-2).</p> <p>In the IEC international standards, this type of test is called an "Immunity test for low-frequency conducted disturbances," and its rules are prescribed in the IEC61000 series of Electromagnetic Compatibility (EMC) standards.</p> <p>Since 1996, devices exported to the EU have been subject to compulsory testing; safety tests called CE Marking (based on directives on low voltage and EMC) must be performed on the devices. The sale of any product without a CE mark, which indicates compliance with the relevant standards, is not permitted.</p>

Term	Description
Harmonics regulations	<p>A wide variety of devices, from household appliances to industrial equipment, already use switching power supplies. Capacitor input-type rectifier circuits are ordinarily used in the power input sections of these devices because such circuits are simple and inexpensive. The greatest drawbacks of this type of circuit are that it largely distorts the power supply input current and that the current contains a lot of harmonics.</p> <p>If a large amount of current from such a source flows into a power supply line, voltage is distorted, possibly causing a device malfunction or a transformer to become excessively hot, either of which could lead to accidents.</p> <p>To prevent this problem, groups have been formed to promote quantitative measurement of harmonics in the input current of devices and to place restrictions related to the properties of these components.</p> <p>In the latter half of the 1970s, a movement to promote standardization started, initiated mainly by groups in European countries. In 1982, the IEC555-2 international standard was released.</p> <p>In 1992, the standard was included in the IEC1000 series of EMC standards, and its name was changed to IEC1000-3-2. The standard was later revised into IEC61000-3-2. Like low-frequency immunity tests, it has been included since 1996 in directives on EMC in CE Marking.</p> <p>Based on these standards, the “Guideline for suppressing harmonics in household, electrical, and general-purpose appliances” was issued under the management of the Agency for Natural Resources and Energy in Japan in September 1994. Individual industries in Japan have started to adopt the guideline and comply with these voluntary restrictions.</p>
QC (Quick Change) Quick change Quick voltage change Quick frequency change Quick phase change	<p>Instantaneous change of the power supply status</p> <p>A quick change in voltage is called a “quick voltage change,” and a quick change in frequency is called a “quick frequency change.” This product can generate both types of changes.</p> <p>Similarly, a quick change in phase is called a “quick phase change,” which may occur during system switching in a commercial power supply. It can be generated when this product is used with the optional ES 0406 low-frequency immunity test program.</p>
Sweep Voltage sweep Frequency sweep	<p>A sweep is a power supply status change made within a certain period (not instantaneously).</p> <p>A linear change in time is called a “linear sweep,” and a logarithmic change is called a “log sweep.”</p> <p>This device can perform linear sweep operations for both voltage and frequency.</p>
Load regulation	<p>Output voltage variations can be caused by load status changes. Generally, the percentage (%) of voltage variation observed when a load is connected to voltage under no load (no load is connected) is displayed.</p>
Line regulation	<p>Output voltage variations can be caused by variations in power supply input voltage. In this device, a variation in output voltage (at rated output) compared to a variation in input voltage (170 V to 250 V) is displayed as a percentage (%) and defined as a rating.</p>

Term	Description
<p>Apparent power Active power Power factor</p>	<p>When power is supplied from an AC power supply to a load, the multiplication of the absolute values of the load current denoted as I_L and the voltage denoted as V_L (I_L and V_L are both effective values) is expressed as $I_L \cdot V_L$. It is called apparent power and displayed in [VA].</p> <p>Of power supplied from a power supply, active power can be expressed as follows:</p> $\frac{1}{T} \int_0^T i_L \cdot v_L dt \quad (i_L \text{ and } v_L \text{ are instantaneous values.})$ <p>Active power is displayed in [W].</p> <p>The ratio of [W] and [VA] is the power factor.</p> <p>In other words, apparent power is power that the AC power supply is supposed to supply, active power is the amount of energy used by the load, and the power factor is the percentage of supplied power used in the load.</p> <p>This product obtains values for detected i_L, v_L, I_L, and V_L by performing calculations equivalent to those explained above.</p>
<p>Stability for capacitive load</p>	<p>In a AC power supply consisting of a power amplifier similar to this device, feedback is generated using an electronic circuit to compensate for output voltage changes caused by load variations. If an excessively large capacitive load is connected, the stability of the feedback circuit deteriorates, which can lead to abnormal phenomena such as oscillation.</p> <p>To prevent this problem, this device provides a feedback circuit compensation mode that can be set when a large capacitive load must be connected.</p> <p>In precision mode, which provides high precision, robustness against a capacitive load is about 20 μF; and in high-stability mode, which places an emphasis on stability, a capacitive load of up to 1000 μF can be connected.</p>
<p>Remote sensing</p>	<p>If the cable connecting the output terminal of an AC power supply to a load becomes longer, the impedance of the cable for the load becomes more significant, since a voltage drop is generated between output voltage and load voltage.</p> <p>When long cables are used, a sensing cable in addition to the power supply cable is connected to monitor voltage at the load end. This method is generally called "remote sensing."</p> <p>This product allows you to select either an external voltage detection point or an internal voltage detection point. If the external point is selected, "remote sensing" mode is entered, and voltage detection input from the load end is possible during the operations of the measurement function and the AGC function described below.</p>
<p>AGC</p>	<p>After detection of an envelope of the absolute values of AC output voltage, the average value (DC value) is used to control the output voltage.</p> <p>Because the control uses a DC value, high voltage stability along with high precision can be maintained. Also, during detection by remote sensing, the detection operation is less susceptible to the influence of AC elements (e.g., impedance) from the sensing cable.</p>

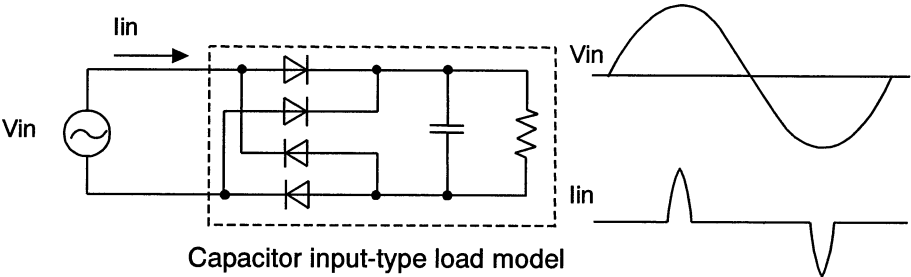
Term	Description
<p>Capacitor input-type load</p>	<p>Most of the switching power supplies in many household appliances and industrial equipment use a capacitor input-type rectifier in their power supply input section, because this type of rectifier is a simple and inexpensive circuit. The power supply input current in devices with such circuits have waveforms in which current flows only near the peak values of a given sine wave voltage. Not only do the resulting currents contain many harmonics components (see “Harmonics regulations”) but the ratio of peak value to effective value (crest factor or CF value) can become as large as 1.5 times to twice that of a linear load (CF = 1.41).</p> <p>To supply such loads with low-distortion voltage, this product is designed so that it can supply current for a CF value of up to 3.5 (equivalent to 70 Ap) (per unit, with a 100-V range, in precision mode).</p>  <p style="text-align: center;">Capacitor input-type load model</p>
<p>GPIB and RS-232</p>	<p>GPIB (general purpose interface bus) is an interface specification that defines hardware and protocols for data transfer, and it is generally and widely used for controlling measuring instruments.</p> <p>Devices with this interface can be connected in a daisy-chain using GPIB cables, so multiple devices can be connected to a single interface connector of a controller (a personal computer is usually used), and an automatic measurement system can be easily configured.</p> <p>RS-232, adopted by the Electrical Industries Association (EIA) in the U.S., is a hardware specification for a serial data transfer interface.</p> <p>Although the latest specification is EIA-232-F, the specification for this device is called RS-232 because both specifications have the same basic specifications and because the name RS-232 is more common. Unlike GPIB, this interface is equipped as standard in almost all personal computers, making it so convenient that only a cable need be prepared for a connection across a distance of several dozen meters. The interface, however, has the disadvantages of low data transfer speed and requiring as many interface connectors as the number of devices to be connected. Therefore, it is considered unsuitable for complicated system configurations.</p> <p>This product has the optional ES 4473 interface board, which is equipped with both types of interfaces so that users can select either one after considering their advantages and disadvantages.</p>

WARRANTY

NF Corporation certifies that this instrument was thoroughly tested and inspected and found to meet its published specifications when it was shipped from our factory.

All **NF** products are warranted against defects in materials and workmanship for a period of one year from the date of shipment. During the warranty period of, **NF** will, at its option, either will repair the defective product without any charge for the parts and labor, or either repair or replace products which prove to be defective. For repair service under warranty, the product must be returned to a service center designated by **NF**. Purchaser shall prepay all shipping cost, duties, and taxes for the product to **NF** from another country, and **NF** shall pay shipping charge to returned the product to purchaser.

This warranty shall not apply to any defect, failure or damage caused by improper use, improper or inadequate maintenance and care or modified by purchaser or personnel other than **NF** representatives.

NF Corporation

WABUN: (≈DA00005802-001)

If there are any misplaced or missing pages, we will replace the manual. Contact the sales representative.

NOTES

- Reproduction of the contents of this manual is forbidden by applicable laws.
- The contents of this manual may be revised without notice.
- Information provided in this manual is intended to be accurate and reliable. However, we assume no responsibility for any damage regarding the contents of this manual.
- We assume no responsibility for influences resulting from the operations in this manual.

Copyright 2004, **NF Corporation**

ES 2000U/ES 2000P/ES 2000B Instruction Manual

NF Corporation

3-20 Tsunashima Higashi 6-chome, Kohoku-ku. Yokohama-shi
223-8508, JAPAN

Phone +81-45-545-8111 Fax +81-45-545-8191

