



HIGH SPEED BIPOLAR AMPLIFIER

**BA4825**

---

**Instruction Manual**

**NF Corporation**



DA00015282-004

HIGH SPEED BIPOLAR AMPLIFIER

**BA4825**

**Instruction Manual**



## — Preface —

Thank you for purchasing the BA4825 high speed bipolar power amplifier.

To ensure safe and proper use of this electric equipment, please read first Safety Precautions on the following pages.

### ● Caution Symbols Used in This Manual

The following caution symbols are used in this manual. Be sure to observe these caution symbols and their contents to ensure the safety of the user and avoid damage to the equipment.

---

** WARNING**

---

This mark indicates information for the avoidance of a hazard such as electric shock that may endanger human life or cause injury during handling of the equipment.

---

---

** CAUTION**

---

This mark indicates information for the avoidance of damage to the equipment during handling.

---

### ● This manual has the following chapter organization.

If reading this manual for the first time, start from 1. OVERVIEW.

#### 1. OVERVIEW

Describes the overview, features, applications, functions, and brief operation principles.

#### 2. PREPARATIONS BEFORE USE

Describes various cautions regarding preparations to be made before using the BA4825.

#### 3. PANEL FEATURES AND BASIC OPERATIONS

Describes features, behavior, and basic operation of panel knobs. Read this chapter while operating the device.

#### 4. ADVANCED OPERATIONS

Describes advanced operations.

#### 5. TROUBLESHOOTING

Describes error messages and countermeasures to be taken when a failure is likely to have occurred.

#### 6. MAINTENANCE

Describes how to store, re-pack, and transport the device, how to run the performance test, and so on.

#### 7. SPECIFICATIONS

Describes the specifications including functions and performance.

## — Safety Precautions —

To ensure safe use, be sure to observe the following warnings and cautions.

NF Corporation shall not be held liable for damages that arise from a failure to observe these warnings and cautions.

This product is a Class 1 product (with protective conductor terminal) that conforms to the JIS and IEC insulation standards.

- **Be sure to observe the contents of this instruction manual.**

This instruction manual contains information for the safe operation and use of this product.

Be sure to read this information first before using this product.

All the warnings in the instruction manual must be heeded to prevent hazards that may cause major accidents.

- **Be sure to ground the product.**

This product uses a line filter and must be grounded to avoid the risk of electric shock.

To prevent electric shock, be sure to safely implement grounding according to Japanese Standard for Electrical Equipment Technology D (Type 3) or higher.

This product is automatically grounded when its 3-prong power supply plug is connected to a 3-prong power outlet with a protective-ground contact.

This product does not come with a 3-prong to 2-prong conversion adapter. When using a separately sold 3-prong to 2-prong conversion adapter, be sure to connect the grounding wire of the adapter to the grounding terminal next to the outlet.

- **Check the power supply voltage.**

This product operates on the power supply voltage indicated in **Grounding and Power Supply Connection** in this instruction manual.

Prior to connecting the power supply, check that the voltage of the power supply matches the rated power supply of the product.

- **In case of suspected anomaly**

If this product emits smoke, an abnormal smell, or abnormal noise, immediately power it off and stop using it.

If such an anomaly occurs, do not use this product until it has been repaired, and immediately report the problem to the location of purchase (either NF Corporation or your distributor).

- **Do not use this product when gas is present.**

An explosion or other such hazard may result.

- **Do not remove the cover.**

This product contains high-voltage parts. Absolutely never remove its cover.

Even when the inside of this product needs to be inspected, do not touch the inside. All such inspections are to be performed by service technicians designated by NF Corporation.

- **Do not modify this product.**

Absolutely never modify this product, as this may cause new hazards and may disqualify this product from repair in case of failure.

- **Avoid output voltage electric shock**

The maximum output of the BA4825 is  $\pm 250$  V.

Make every effort to avoid an electric shock.

Directly touching the output or changing cable connections while output is on may cause electrical shock.

- **Do not expose this product to water.**

When this product is used in wet condition, it may cause an electric shock and a fire. If this product is exposed to water, unplug the power cord immediately, and contact NF Corporation or one of our representatives.

- **If lightning occurs, power off this product and unplug the power cord.**

A lightning may cause an electric shock, a fire and a failure.

- **Safety-related symbols**

The general definitions of the safety-related symbols used on this product and in the instruction manual are provided below.



**Instruction Manual Reference Symbol**

This symbol is displayed to alert the user to potential danger and refer him/her to the instruction manual.



**Electric Shock Danger Symbol**

This symbol indicates locations that present a risk of electric shock under specific conditions.



**Protective Ground-Terminal Symbol**

This symbol identifies a pin that must be grounded to avoid an electric shock.

Before operating the device, be sure to safely implement grounding according to Japanese Standard for Electrical Equipment Technology D (Type 3, 100  $\Omega$  or lower) or higher.



**Warning Symbol**

This symbol indicates information for avoiding danger to human life or bodily injury while handling this product.



**Caution Symbol**

This symbol indicates information for preventing damage to the product when handling it.

- **Other symbols**



This symbol indicates the “on” position of the power switch.



This symbol indicates the “off” position of the power switch.



This symbol indicates that the external conductor of the connector is connected to the case.



This symbol indicates that the external conductor of the connector is connected to the signal ground.

- **Notes for Disposal**

When disposing of this product, ask a company that handles industrial waste, to ensure environmental protection.



---

# Contents

---

	Page
<b>1. OVERVIEW .....</b>	<b>1-1</b>
1.1 General.....	1-2
1.2 Features .....	1-3
1.3 Applications.....	1-4
1.4 List of Functions .....	1-4
1.5 Principle of Operation .....	1-5
<b>2. PREPARATIONS BEFORE USE .....</b>	<b>2-1</b>
2.1 Checking Before Use.....	2-2
2.2 Setup and Installation .....	2-3
2.3 Grounding and Power Supply Connection .....	2-5
2.4 Simplified Operation Check.....	2-6
2.5 Calibration.....	2-9
2.6 Radio Law .....	2-10
<b>3. PANEL FEATURES AND BASIC OPERATIONS.....</b>	<b>3-1</b>
3.1 Panel Component Designations and Operations .....	3-2
3.1.1 Front panel .....	3-2
3.1.2 Rear panel.....	3-3
3.2 Indications at Power-on and Initialization .....	3-4
3.3 I/O Terminals .....	3-4
3.3.1 Input connector: A (front)/B (rear).....	3-4
3.3.2 Main output.....	3-5
3.3.3 Monitor output.....	3-6
3.3.4 External control I/O .....	3-6
3.4 I/O Connection .....	3-8
3.4.1 Signal generator.....	3-8
3.4.2 Signal cords .....	3-9
3.4.3 Load.....	3-9
3.5 Examples of Basic Operations .....	3-10
3.5.1 Input selection and input impedance selection.....	3-10
3.5.2 Voltage range selection .....	3-10
3.5.3 Output voltage adjustment .....	3-11
3.5.4 Fine output offset adjustment .....	3-11
3.5.5 DC bias addition.....	3-12
3.5.6 Output polarity switching .....	3-12
3.5.7 Output voltage monitoring.....	3-13
3.5.8 Output on/off control .....	3-14
3.6 Setting at Power-on.....	3-14
<b>4. ADVANCED OPERATIONS.....</b>	<b>4-1</b>
4.1 Maximum Output Current and Operation Range .....	4-2
4.2 Increasing of Output .....	4-5
<b>5. TROUBLESHOOTING.....</b>	<b>5-1</b>
5.1 Error Messages.....	5-2
5.1.1 Errors at Power-on.....	5-2
5.1.2 Errors related to the protection function .....	5-3
5.2 When Fault Symptoms Are Observed .....	5-5
<b>6. MAINTENANCE .....</b>	<b>6-1</b>
6.1 Introduction .....	6-2
6.2 Daily Maintenance .....	6-3
6.3 Storage, Repacking, and Transportation .....	6-4
6.4 Performance Testing .....	6-5
6.4.1 Measurement of maximum output voltage.....	6-6

---

6.4.2	Measurement of maximum output power .....	6-7
6.4.3	Measurement of frequency characteristics .....	6-8
6.4.4	Measurement of gain error .....	6-10
6.4.5	Measurement of sine wave distortion factor .....	6-11
6.4.6	Measurement of bias-added voltage .....	6-12
<b>7.</b>	<b>SPECIFICATIONS .....</b>	<b>7-1</b>
7.1	Input .....	7-2
7.2	Output .....	7-3
7.3	Monitor Output.....	7-8
7.4	Protection Function.....	7-8
7.5	External Control I/O.....	7-9
7.6	Output On/Off Control .....	7-9
7.7	Setting at Power-on .....	7-10
7.8	Power Input.....	7-10
7.9	Safety and EMC .....	7-10
7.10	Ambient Temperature Range, Ambient Humidity Range, Etc. ....	7-11
7.11	External Dimensions and Weight.....	7-12

---

# Figures

---

	Page
Figure 1-1. Block Diagram .....	1-5
Figure 2-1. Standard Connection Diagram .....	2-7
Figure 3-1. BA4825 Front Panel .....	3-2
Figure 3-2. BA4825 Rear Panel.....	3-3
Figure 3-3. External Control I/O .....	3-7
Figure 3-4. Basic Connection Diagram .....	3-8
Figure 3-5. CAL Position of Control for Fine Adjustment (VAR).....	3-11
Figure 3-6. Center Position of Offset Fine Adjustment .....	3-11
Figure 4-1. Operation Range (–50 V to +250 V range) .....	4-2
Figure 4-2. Operation Range ( $\pm 150$ V range) .....	4-3
Figure 4-3. Operation Range (–250 V to +50 V range) .....	4-3
Figure 4-4. Current Waveform Asymmetric with Regard to Polarity .....	4-4
Figure 4-5. Connection of Two BA4825 Units .....	4-5
Figure 6-1. Air Filter Cleaning Procedure .....	6-3
Figure 6-2. Measurement of Maximum Output Voltage .....	6-6
Figure 6-3. Measurement of Maximum Output Power .....	6-7
Figure 6-4. Measurement of Frequency Characteristics .....	6-9
Figure 6-5. Measurement of Sine Wave Distortion Factor .....	6-11
Figure 6-6. Measurement of Bias-Added Voltage .....	6-12
Figure 7-1. Output Voltage/Current Range (AC) .....	7-6
Figure 7-2. Output Voltage/Current Range (DC) .....	7-7
Figure 7-3. Ambient Temperature and Humidity Ranges .....	7-11
Figure 7-4. External Dimensions .....	7-13

---

# Tables

---

	Page
Table 1-1. List of Functions .....	1-4
Table 2-1. Required Measuring Instruments .....	2-6
Table 2-2. Panel Setting for Operation Check .....	2-7
Table 3-1. List of External Control I/O Connector Pins .....	3-6
Table 3-2. List of DIP Switch Settings .....	3-15
Table 5-1. Diagnosis Performed at Power-on .....	5-2
Table 5-2. Errors Related to Protection Function (1/2).....	5-3
Table 5-3. Errors Related to Protection Function (2/2).....	5-4
Table 5-4. When Fault Symptoms Are Observed (1/2) .....	5-5
Table 5-5. When Fault Symptoms Are Observed (2/2) .....	5-6
Table 6-1. Judgment of BA4825 Performance .....	6-13

# 1. OVERVIEW

1.1	General.....	1-2
1.2	Features .....	1-3
1.3	Applications .....	1-4
1.4	List of Functions .....	1-4
1.5	Principle of Operation .....	1-5

### 1.1 General

The BA4825 is a 50 VA wideband, high-speed bipolar power amplifier with a 2 MHz band capable of bipolar output of an output voltage and current.

Constant voltage (CV) output characteristics are supported, and the rated output voltage and current are 100 V<sub>rms</sub> and 0.5 A<sub>rms</sub>, respectively.

Since the BA4825 performs bipolar output, the output voltage and current supply ranges over all four quadrants. A general DC power supply can supply only positive current (source current) in the case of positive voltage output. The BA4825, however, can supply both positive and negative (source and sink) current. The BA4825 can be used with DC, so that an offset waveform or a waveform asymmetric with regard to polarity can also be amplified.

## 1.2 Features

- **Wideband, high speed, and large amplitude**

The BA4825 has a frequency band from DC to 2 MHz and a slew rate as high as 500 V/ $\mu$ s or more, and still can output a maximum amplitude of 300 V<sub>p-p</sub>.

- **Low output impedance**

With 0.5  $\Omega$  + 1.5  $\mu$ H or less (typ.), the load range usable without being concerned about impedance matching is extended.

- **Output voltage range switching function**

The BA4825 provides three output voltage ranges: -250 V to +50 V, -150 V to +150 V, and -50 V to +250 V. A desirable range can be selected for an application.

- **Output polarity switching function**

A switch is provided to enable the BA4825 to be switched for use as an in-phase amplifier or a reversed-phase amplifier.

- **Protection function**

The BA4825 protects against output overload and also protects against power supply faults, abnormal internal temperatures, and so forth.

- **Output monitor function**

The BA4825 enables output voltage monitoring based on a monitor ratio of 1/100 (BNC connector output), and also enables output voltage/current checking (switchable, average value indication) with a meter.

- **Output on/off function**

Output on/off control can be exercised by using the front panel switch or an external control.

Moreover, an output state (output off or output on) at power-on time can be selected using the DIP switch on the rear panel.

- **Support of worldwide power supply input voltages**

A voltage range from 100 to 230 VAC  $\pm$ 10% is supported. The input power factor control (PFC) function is provided.

## 1.3 Applications

- For testing and characteristics analysis of FEDs, liquid crystals, and so forth
- For testing and characteristics analysis of micro actuators and so forth
- For use as a booster amplifier for signal generators such as the WF series of NF Corporation
- For use as a power supply for capacitor ripple current testing
- For use as an actuator driver
- For characteristics testing of diodes and semiconductors such as SCR
- For characteristics testing of relays and switches
- For use as a power supply for testing in an inspection line for various components

## 1.4 List of Functions

The table below indicates the major functions of the BA4825.

**Table 1-1. List of Functions**

	Function	Description
Input	Input on/off switching	Two independent inputs. Two inputs added when two are on.
	Input impedance switching	50 $\Omega$ /10 k $\Omega$ . Two batch-switched inputs.
Output	Output on/off switching	
	Fine DC offset tuning	$\pm 0.5$ V
	DC bias setting	Settable to $\pm 200$ V or more. Settable to on/off.
	Output voltage range switching	-250 V to +50 V -150 V to +150 V -50 V to +250 V
	Gain setting	Fixed: $\times 1$ , $\times 10$ , $\times 20$ , $\times 50$ Variable: $\times 1$ to $\times 3$
	Output polarity switching	In-phase or reversed-phase
	Overload protection and indication	
Monitor	Output voltage monitoring	BNC output, monitor ratio 1:100
	Monitor meter	Switching output voltage/current display
Other	To be set at power-on time	Output on/off, gain, and so forth



## 1.5 Principle of Operation

The BA4825 consists of a panel block, preamplifier block, power amplifier block, power supply block, and system control block. "Figure 1-1. Block Diagram" shows the block diagram of the BA4825.

The panel block provides the gain tuning function, input impedance switching function, two-input addition function, offset tuning function, and bias addition function.

The preamplifier block is a wideband operational amplifier. A feedback technique is employed.

The power amplifier block performs power amplification and has protection functions.

The power supply block consists of the internal power supply block of the BA4825, and the DC power supply block for the power amplifier with a function for shifting voltage in phase with the output range.

The system control block provides a user interface and interfaces among the blocks.

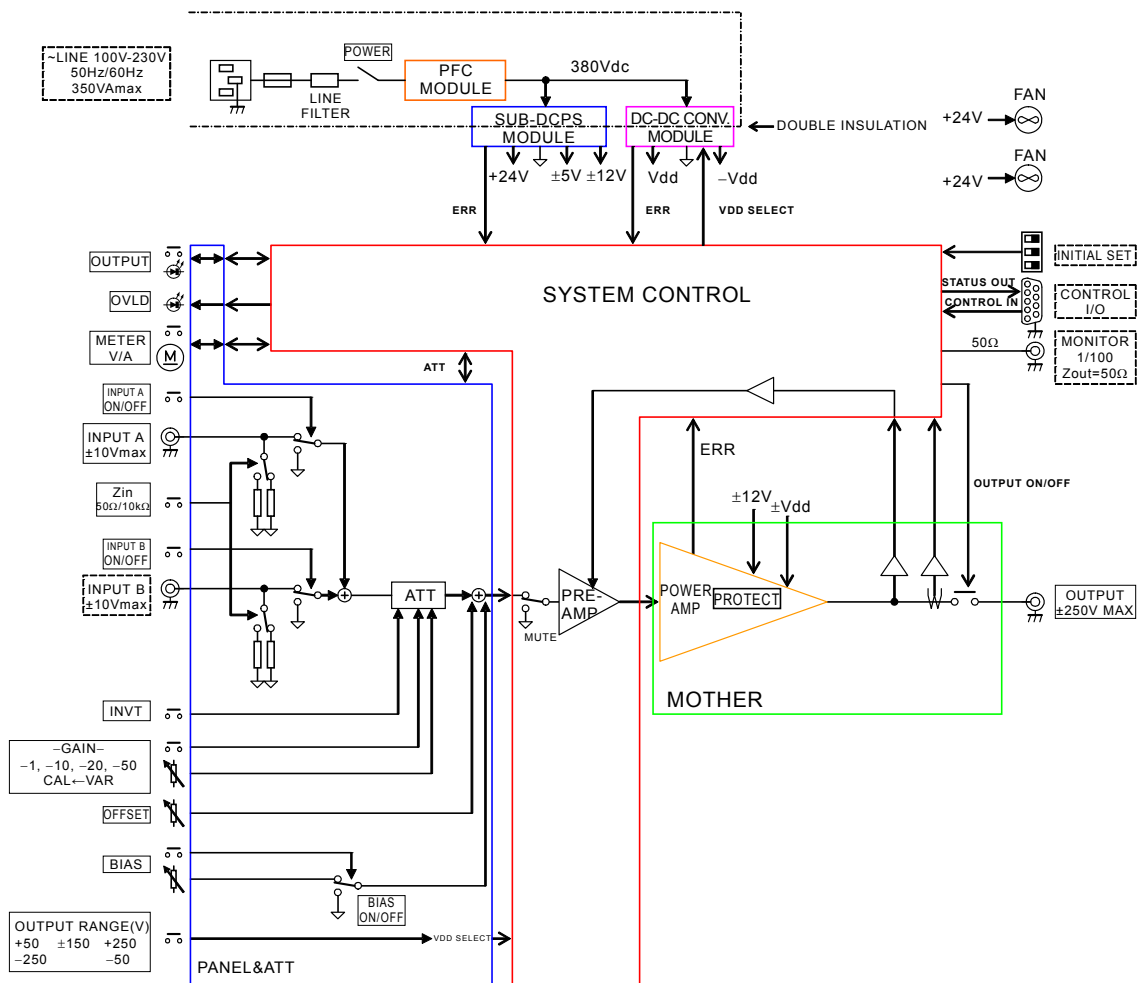

Figure 1-1. Block Diagram



## 2. PREPARATIONS BEFORE USE

2.1	Checking Before Use .....	2-2
2.2	Setup and Installation .....	2-3
2.3	Grounding and Power Supply Connection .....	2-5
2.4	Simplified Operation Check.....	2-6
2.5	Calibration .....	2-9
2.6	Radio Law.....	2-10

## 2.1 Checking Before Use

### ■ Safety check

To ensure safety in using the BA4825, the user should read the following sections of this instruction manual before using the BA4825:

- "Safety Precautions" (provided at the beginning of this instruction manual)
- "2.3 Grounding and Power Supply Connection"

### ■ Appearance and accessories check

If an abnormality (such as a flaw or dent) is found on the outside surface of the corrugated box, carefully check if the product is adversely affected when removing the product from the corrugated box.

After opening the corrugated box, check the items contained in the box.

If an abnormality such as a flaw or dent is found on the product, or an accessory is missing, contact NF Corporation or its representative.

#### ● Appearance check

Check that no abnormalities such as a flaw and dent are found on the panel, controls, connectors, and so forth.

#### ● Accessories check

The accessories of this product are listed below. Check that there are no missing items and no flaws are found.

● Instruction manual (BA4825 Instruction Manual)	1
● Power cord set (varies depending on destination, 7 A/125 V for Japan)	1

---

### WARNING

This product contains high-voltage parts. Never remove the cover.

All internal inspections of this product are to be performed only by service technicians qualified by NF Corporation.

---

## 2.2 Setup and Installation

### ■ Installation location

Do not place the BA4825, with its rear or side facing down, on a floor or desk.

Ensure that all of the four rubber legs at the bottom are placed on a plane surface such as a desk.

If the BA4825 is placed with its rear facing down, the BA4825 can fall, resulting in a product failure or physical harm.

### ■ Caution on transportation

When transporting the BA4825, hold the handles on the sides and ensure that the product is level.

### ■ Rack mounting

The BA4825 can be mounted in a metric- or inch-standard rack using mounting hardware. Contact the sales staff at NF Corporation and specify a metric or inch rack.

---

#### CAUTION

##### **Rack mounting**

- Use a rack with an effective depth of 70 cm or more.
  - Retain the BA4825 by using a rail or shelf to withstand sufficient shock and vibration.
  - Provide a space of 5 cm or more above and below the BA4825 to allow circulation of air for cooling the inside of the BA4825. Moreover, open the back of the rack to prevent air output from the rear panel from being contained in the rack, and separate the rack from the wall by 30 cm or more.
-

## 2.2 Setup and Installation

### ■ Installation location conditions

- Use the BA4825 indoors at an altitude of no higher than 2000 m.
- The BA4825 performs forced air cooling using fans. Separate the front, rear, and sides with air inlets and air outlets from the wall by 50 cm or more to assure ventilation.
- Install the BA4825 in a location that satisfies the following temperature and humidity ranges:

Operation guarantee	0°C to 40°C	5% to 85% RH. Absolute humidity 1 to 25 g/m <sup>3</sup> , with no condensation.
Performance guarantee	+5°C to 35°C	5% to 85% RH. Absolute humidity 1 to 25 g/m <sup>3</sup> , with no condensation.
Storage condition	-10°C to +50°C	5% to 95% RH. Absolute humidity 1 to 29 g/m <sup>3</sup> , with no condensation.

Product reliability may decline in extreme temperature and/or humidity environments. An environment of approximately 25°C and 50%RH is recommended.

- Do not install the BA4825 in the following locations:
  - Location with flammable gas  
→ An explosion may occur. Never install and use this product in such a location.
  - Outdoors, or location exposed to direct sunlight or near a fire or heat source  
→ The full performance of this product may not be obtained, or failure may occur.
  - Location with corrosive gas, moisture, or high humidity  
→ This product may become corroded or fail.
  - Location near an electromagnetic field source, high-voltage device, or power line  
→ This product may malfunction.  
The output may become off if the BA4825 is exposed to a strong radiated radio frequency electromagnetic field.
  - Location exposed to excessive vibration  
→ This product may malfunction or fail.
  - Location with excessive dust  
→ In particular, electrically conductive dust may cause failure of this product.
- This product may cause interference if used in residential areas. Such use must be avoided unless the user takes special measures to reduce electromagnetic emissions to prevent interference to the reception of radio and television broadcasts.

### 2.3 Grounding and Power Supply Connection

- Be sure to ground the BA4825.

---

**⚠ WARNING**

---

This product uses a line filter. Be sure to ground this product. Otherwise, an electric shock may occur.

To prevent an electric shock from occurring, be sure to ground the BA4825 according to "Electric Equipment Technical Standard Class D (100  $\Omega$  or below) Grounding" or higher.

---

This product is automatically grounded when its 3-prong power supply plug is connected to a 3-prong power outlet with a protective-ground contact.

This product does not come with a 3-prong to 2-prong conversion adapter. When using a separately sold 3-prong to 2-prong conversion adapter, be sure to connect the grounding wire of the adapter to the grounding terminal next to the outlet.

---

**⚠ CAUTION**

---

The power code set can be used for disconnecting the product from AC power line in case of emergency. Maintain enough space around the inlet, to be able to remove the connector of a power cord from the inlet. Use a power socket located at convenient place with adequate space around so that the plug can be removed from socket.

---

- The power requirements of this product are as follows:

Voltage range:	100 V AC to 230 V AC $\pm 10\%$ (not exceeding 250 V) Overvoltage Category II
Frequency range:	50 Hz/60 Hz $\pm 2$ Hz (single phase)
Power consumption:	350 VA or less

- Connect the power supply according to the following procedure:

1. Check that the commercial voltage supply to be connected is within the voltage range of the BA4825.
2. Turn off the power switch of the BA4825.
3. Insert the power cord supplied with the product into the inlet on the rear.
4. Insert the plug of the power cord into a 3-pole power outlet.

---

**⚠ CAUTION**

---

The power cord set accompanying this product for use in Japan conforms to the Electric Appliances and Material Safety Law and can be used only in Japan. The rated voltage is 125 VAC, and the dielectric strength is 1250 VAC. The product, shipped to Japan, cannot be used with a voltage exceeding 125 VAC and cannot be used outside Japan.

---

## 2.4 Simplified Operation Check

### CAUTION

The power cord set delivered with this product is dedicated to this product.  
Do not use the power cord for other products and applications.  
Use only the attached power code set for connection to AC power line.

Note that the dielectric strength of only the main unit of this product is 1500 VAC.

## 2.4 Simplified Operation Check

This section describes the simplified operation check method, which may be used when the BA4825 is newly purchased or after being stored for a long time. For performance checking, refer to "**6.4 Performance Testing**".

### WARNING

This product contains high-voltage parts. Never remove the cover.  
All internal inspections of this product are to be performed only by service technicians qualified by NF Corporation.

#### ● Required measuring instruments

To make an operation check, the measuring instruments listed below are required.  
No load test is conducted. So a load (terminating) resistor is not needed.

**Table 2-1. Required Measuring Instruments**

Measuring instrument	Characteristics
Signal generator	Frequency: 1 kHz Waveform: Sine wave Output voltage: 0.5 Vrms or more (Load: 50 Ω) WF1947 1 CH 30 MHz multifunction generator manufactured by NF Corporation, or equivalent
Oscilloscope	Frequency band: 20 MHz or more Use an oscilloscope that can measure 300 V or higher by using a 10:1 probe <sup>Note</sup> . GDS1072B 2 CH 70 MHz digital storage oscilloscope manufactured by NF Corporation, or equivalent
Voltmeter	AC and DC voltage measurement Use a voltmeter that can measure 300 V or higher.

**Note:** When connecting an oscilloscope for measurements, be sure to use a 10:1 probe.



## 2.4 Simplified Operation Check

- Connection

As shown in "Figure 2-1 Standard Connection Diagram", connect a signal generator, voltmeter, and oscilloscope.

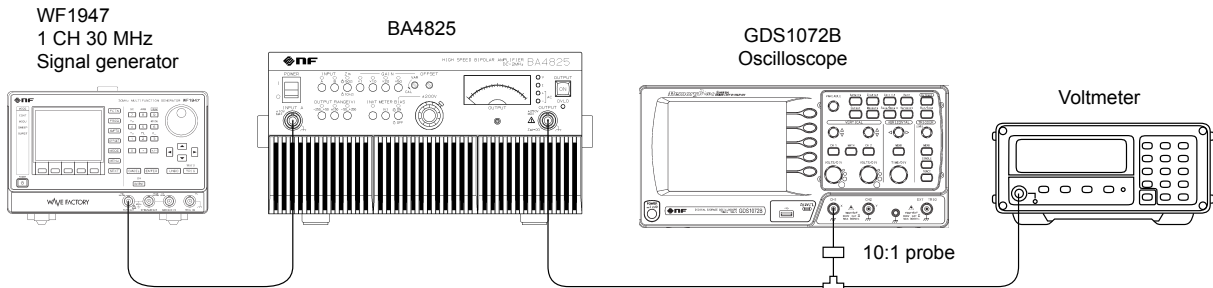

Figure 2-1. Standard Connection Diagram

- Panel setting

Set the BA4825 and signal generator as indicated below.

Table 2-2. Panel Setting for Operation Check

BA4825

Item	Setting
INPUT	Set A to ON.
Zin	50 $\Omega$
GAIN	$\times 50$
VAR	CAL
OUTPUT RANGE (V)	$\pm 150$
INVT	OFF
METER	V
BIAS	OFF (Dial scale: 5.00)

Signal generator (WF1947)

Item	Setting
Frequency (FREQ)	1 kHz
Waveform (FUNCTION)	Sine wave
Output level (AMPTD)	0
Offset (OFFSET)	0

## 2.4 Simplified Operation Check

- Operation

---

**⚠ WARNING**

---

If the product generates smoke, smell, or sound, disconnect the power cord from the outlet immediately, and leave a notice that the product must not be used until the product is repaired.

---

1. Turn on the power switch.

All LEDs on the push buttons turn on. Then, after the LED beside the output meter makes a "V→I→V" change (when the V meter is selected at power-on time) and the overload LED (OVL D) turns on, all LEDs other than the output meter status LED (with the meter polarity indication LED undefined) turn off. Next, when the three LEDs of OUTPUT RANGE blink, and the internal power supply is fixed, the state selected at power-on time is set.

If the output voltage range is not in the  $\pm 150$  V range, or the gain setting is not  $\times 50$ , change the setting.

2. Check that the output meter indicates 0 V.
3. Set the frequency of the signal generator to 1 kHz, the waveform to sine wave, and the voltmeter for AC measurement.
4. Increase the level gradually from 0 V, and set the BA4825 input voltage to 1 Vrms (check the input voltage with the voltmeter). At this time, check that the output meter indication changes from 0 V to 50 V.
5. Press the output ON/OFF switch then check, with the oscilloscope and voltmeter, that about 50 Vrms is output on the output connector (OUTPUT). At the same time, check that the waveform does not have any distortion, such as clipping.
6. Switch the gain setting then check the output level.

GAIN	Output Level
$\times 20$	20 Vrms
$\times 10$	10 Vrms
$\times 1$	1 Vrms

7. Set the level of the signal generator to 0 V, set the bias of the BA4825 to ON, and set the voltmeter for DC measurement. Next, by tuning the bias dial, check the output meter indication and output voltage.

Scale division	2.00	3.00	5.00	7.00	8.00
Output	Approx. -130 V	Approx. -85 V	Approx. 0 V	Approx. +85 V	Approx. +130 V
Meter indication	Approx. -130 V	Approx. -85 V	Approx. 0 V	Approx. +85 V	Approx. +130 V

8. Switch the voltage range then check the output voltage range.

When the voltage range is switched, the output is turned off. For voltage switching, about 3 seconds is needed. When the OUTPUT RANGE LED stops blinking and the output range is determined, turn on the output again.

9. Set the bias to ON and tune the bias dial, then check the output meter indication and output voltage.

Range	Dial Setting
-250...+50	A voltage from -200 V or below to +50 V or above can be output with 0.00 to 6.25.
-50...+250	A voltage from -50 V or below to +200 V or above can be output with 3.75 to 10.00.

Upon completion of the operation check, set the bias to OFF and return the bias dial to 5.00 for safety.

## 2.5 Calibration

Ensure that this product undergoes the testing described in "**6.4 Performance Testing**" at least once a year, depending on the use environment and use frequency. It is recommended to conduct a performance test before using it for an important measurement or test.

A performance test should be conducted by a person who has a general knowledge of measuring instruments and is familiar with measuring instrument handling.

## 2.6 Radio Law

---

### ⚠ CAUTION

---

The high-frequency application equipment provisions of Japan's Radio Law may be applicable to the BA4825, depending on the conditions of use.

---

a) Related laws and regulations are summarized as follows:

- Article 100 of the Radio Law defines the following equipment as "high-frequency application equipment":
  - (1) Telegraph, telephony, or other telecommunications facilities that apply a radio frequency current of 10 kHz or higher to a electrical line.
  - (2) Radio equipment and the equipment other than the equipment defined in (1), above that use a high-frequency current of 10 kHz or higher and specified by Ministry of Internal Affairs and Communications regulations.
  
- The "Ministry of Internal Affairs and Communications regulations" mentioned above refer to Article 45 of the Regulations for Enforcement of the Radio Law. Under this article, equipment that requires authorization is defined as follows:
  - (1) Medical equipment (equipment used for medical treatment that generates high-frequency energy and that uses output greater than 50 W)
  - (2) Industrial heating equipment (equipment used for industrial heating that generates high-frequency energy and that uses output greater than 50 W)
  - (3) Various types of equipment (equipment that imparts high-frequency energy to a load for heat generation or ionization and that uses output greater than 50 W)
  
- If the usage mode corresponds to "high-frequency application equipment" as defined above, according to Article 26 of the Radio Station License Procedure Regulations, the required application must be submitted to the Bureau of Telecommunications that has jurisdiction over the location where the equipment is installed, and the approval of the Minister of Internal Affairs and Communications must be received.

**For details → Refer to Article 100 of the Radio Law, Article 45 of the Regulations for Enforcement of the Radio Law, Article 26 of the Radio Station License Procedure Regulations, and Article 65 of the Radio Equipment Law.**

b) Instead of submitting an application to the Bureau of Telecommunications, it is also possible to submit an application by using the Electronic Applications and Notification System of the Ministry of Internal Affairs and Communications over the Internet.

## 2.6 Radio Law

---

- c) The application forms and instructions can be obtained at the website of each Bureau of Telecommunications or the website of the Ministry of Internal Affairs and Communications: Electronic Applications and Notification System, as well as procedure details and information about other documents to be attached to the application forms.
- d) Applications must be submitted by the person who installed the equipment, since information such as the installation location must be filled in.
- e) The BA4825's external view drawings or photographs are required as attached documents.

For any question or further information, contact an NF Corporation sales representative.



## 3. PANEL FEATURES AND BASIC OPERATIONS

3.1	Panel Component Designations and Operations	3-2
3.1.1	Front panel	3-2
3.1.2	Rear panel	3-3
3.2	Indications at Power-on and Initialization	3-4
3.3	I/O Terminals	3-4
3.3.1	Input connector: A (front)/B (rear)	3-4
3.3.2	Main output	3-5
3.3.3	Monitor output	3-6
3.3.4	External control I/O	3-6
3.4	I/O Connection	3-8
3.4.1	Signal generator	3-8
3.4.2	Signal cords	3-9
3.4.3	Load	3-9
3.5	Examples of Basic Operations	3-10
3.5.1	Input selection and input impedance selection	3-10
3.5.2	Voltage range selection	3-10
3.5.3	Output voltage adjustment	3-11
3.5.4	Fine output offset adjustment	3-11
3.5.5	DC bias addition	3-12
3.5.6	Output polarity switching	3-12
3.5.7	Output voltage monitoring	3-13
3.5.8	Output on/off control	3-14
3.6	Setting at Power-on	3-14

## 3.1 Panel Component Designations and Operations

### 3.1.1 Front panel

The number to the right of each component designation in the figure indicates the section where the component is described in detail.

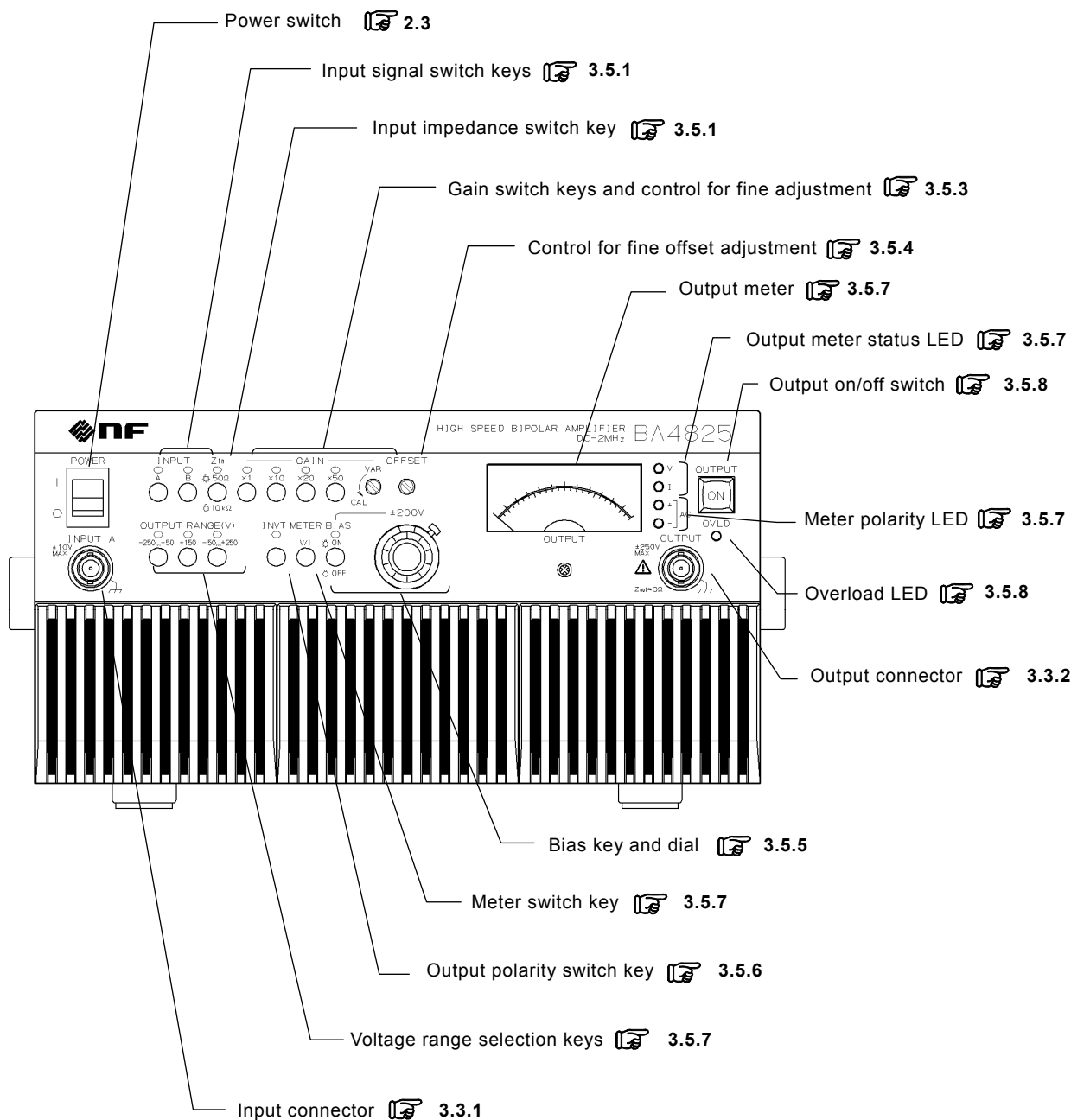

Figure 3-1. BA4825 Front Panel



3.1.2 Rear panel

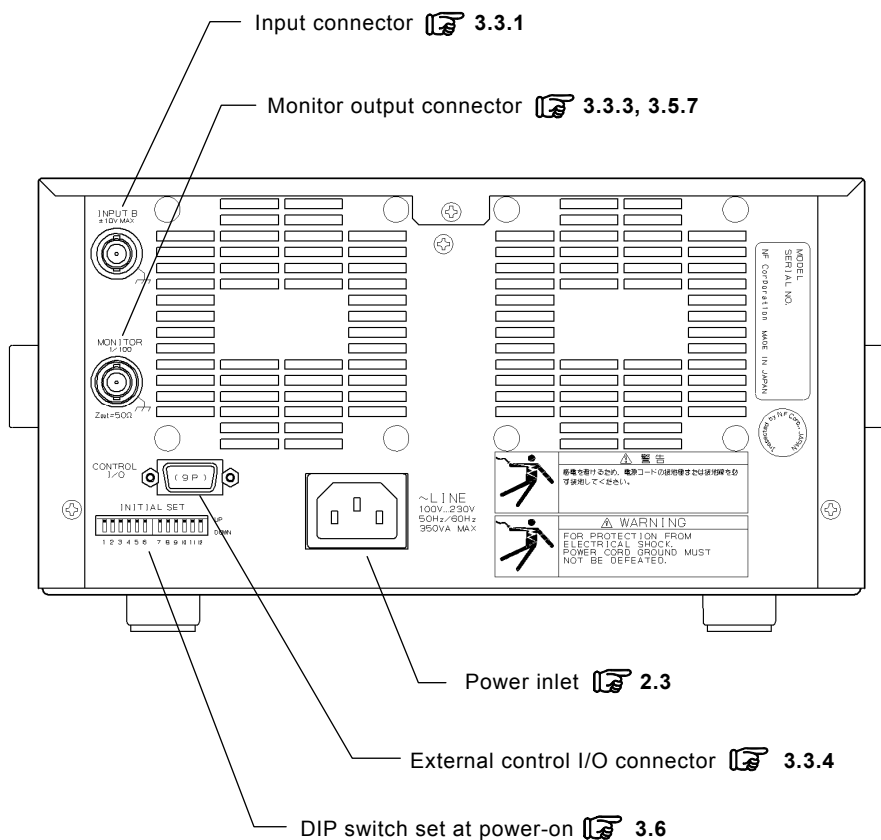

Figure 3-2. BA4825 Rear Panel

## 3.2 Indications at Power-on and Initialization

When the power switch is set to ON, the internal circuitry is automatically checked, and the BA4825 becomes ready for operation if no abnormality is detected. On the panel, the values set with the DIP switch are set. For the initial setting of the DIP switch, refer to "**3.6 Setting at Power-on**".

If the BA4825 cannot be operated after the power is turned on, a fault has occurred. Turn off the power immediately and then contact NF Corporation or its representative.

For fault diagnosis at Power-on, refer to "**5.1.1 Errors at Power-on**".

When the power is turned on, all LEDs on the push buttons are turned on. Next, after the LED beside the level meter makes a "V→I→V" change (when the V meter is selected at Power-on) and the overload LED (OVLD) is turned on, all LEDs other than the output meter status LED (with the meter polarity indication LED undefined) are turned off. Next, when the three LEDs of OUTPUT RANGE blink, and the internal power supply is determined, the state selected at Power-on is set.

## 3.3 I/O Terminals

### 3.3.1 Input connector: A (front)/B (rear)

Signal input connectors are provided. Select A or B with the corresponding input signal selection key (INPUT A/INPUT B). If both of the A and B keys are pressed, both signals are added.

• Input connector	BNC connector [A (front), B (rear)]
• Input impedance	Select 50 Ω or 10 kΩ.
• Non-destructive maximum input voltage	±11 V

---

#### CAUTION

The BA4825 may be damaged if a voltage beyond the non-destructive maximum input voltage ( $\pm 11$  V) is applied.

Never apply a voltage beyond  $\pm 11$  V.

---

### 3.3.2 Main output

A main output connector is provided.

For output voltage signal setting, refer to "3.5.2 Voltage range selection" to "3.5.6 Output polarity switching".

- Output connector                      BNC connector (front)
- Maximum output voltage             $\pm 150$  V range: Resistance load  $200 \Omega$ 

100 V <sub>rms</sub> or more	40 Hz to 500 kHz
70 V <sub>rms</sub> or more	500 kHz to 1 MHz
40 V <sub>rms</sub> or more	1 MHz to 2 MHz

$\pm 150$ V range: Resistance load $450 \Omega$	
$\pm 150$ V (300 V <sub>p-p</sub> )	DC to 500 kHz
$\pm 100$ V (200 V <sub>p-p</sub> )	500 kHz to 1 MHz
$\pm 56$ V (112 V <sub>p-p</sub> )	1 MHz to 2 MHz

+250 V range: Resistance load $1250 \Omega$	
-50 V to +250 V	DC to 500 kHz
+40 V to +240 V	500 kHz to 1 MHz
+80 V to +200 V	1 MHz to 2 MHz

-250 V range: Resistance load $1250 \Omega$	
-250 V to +50 V	DC to 500 kHz
-240 V to -40 V	500 kHz to 1 MHz
-200 V to -80 V	1 MHz to 2 MHz
- Rated output current                0.5 Arms ( $\pm 150$  V range, resistance load  $200 \Omega$ )
- Output impedance                     $0.5 \Omega + 1.5 \mu\text{H}$  (typ.)

#### WARNING

The maximum output voltage of the BA4825 is  $\pm 250$  V. An electric shock can occur if the output connector is directly touched. For safe use, be sure to observe the following:

- Turn off the power when making connections.
- Do not touch the output connector, output cable ends, load, or connected device terminals when the power is on.

In particular, never touch these parts with wet hands.

#### 3.3.3 Monitor output

The BA4825 has a monitor output connector for observing an output voltage. An output waveform can be observed by connecting an oscilloscope directly to the connector.

The monitor output connector outputs a voltage, regardless of the output on/off setting. A voltage as small as 1/100 of the main output level is output.

- Output terminal                                      BNC connector (rear)
- Monitor ratio                                        1/100 of output voltage (in phase as output voltage)
- Output impedance                                 50  $\Omega$

#### 3.3.4 External control I/O

The BA4825 has an external control I/O connector with D-sub 9 pins.

Output on/off control can be exercised externally by using a no-voltage contact. (Refer to "**Figure 3-3 External Control I/O**".)

The overload state and output on/off state can be monitored externally. The overload state is indicated when a connection is made between pins 6 and 7. The output on state is indicated when a connection is made between pins 8 and 9.

To turn on output with the external control I/O function, turn on the power after depressing DIP switch 4 to be set at Power-on. (A DIP switch setting change made after operation is started is not reflected.) If output is turned on with the external control I/O function, the output on/off switch (OUTPUT) on the front panel can only be set to OFF.

To turn on output again after output is turned off using the output on/off switch (OUTPUT), the control signal must first be turned off prior to turning on output.

After the external signal input level was changed, approx. 20ms might be required for the controller to execute a function as a maximum response time. "Output ON/OFF" additionally requires the similar time for a response of a relay device.

**Table 3-1. List of External Control I/O Connector Pins**

(See "**Figure 3-3 External Control I/O**".)

Pin No.	Name	Description
1	+5 V	Power supply for external output on/off (50 mA or less)
6	External output on/off (A)	Connected to the primary side of the photocoupler via 150 $\Omega$
2	External output on/off (K)	
7	+5 V common	Connected to the +5 V common potential (housing potential) via 100 $\Omega$
4	Not used	-
3	Overload (C)	The overload state is set when a connection is made between pins 6 and 7. (15 V or less and 10 mA or less between the pins)
8	Overload (E)	
9	Output on/off (C)	The output on state is set when a connection is made between pins 8 and 9. (15 V or less and 10 mA or less between the pins)
5	Output on/off (E)	

### 3.3 I/O Terminals

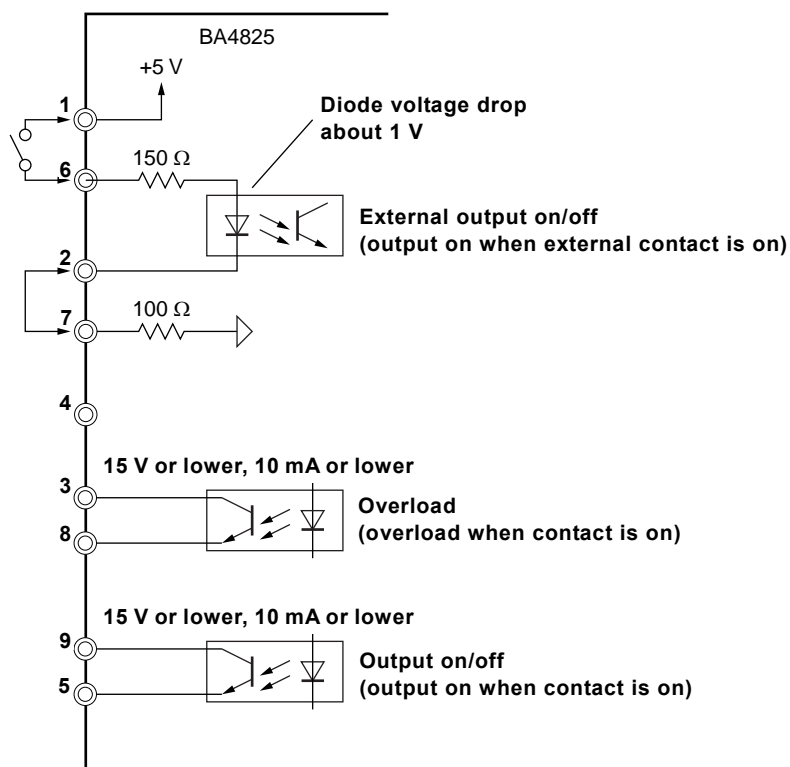
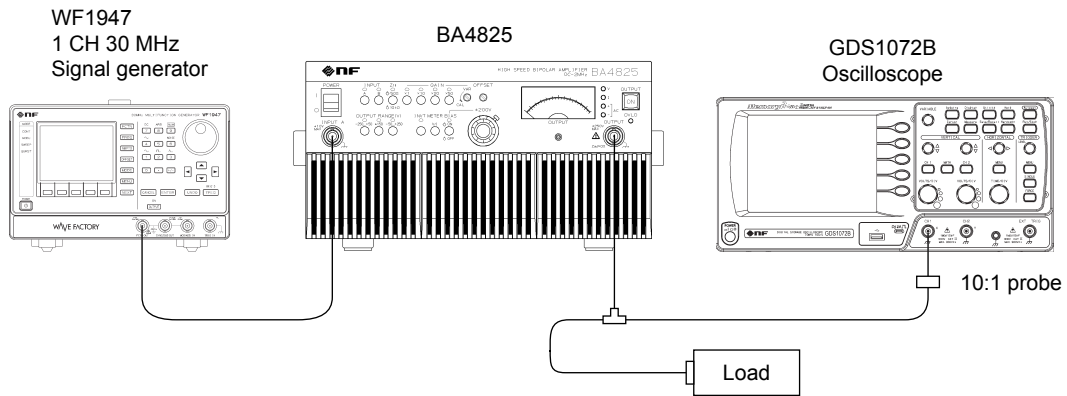

Figure 3-3. External Control I/O

## 3.4 I/O Connection

**Figure 3-4 Basic Connection Diagram** shows the connection diagram.

For full performance of the BA4825, connect a signal generator, signal cords, and a load, observing the descriptions provided in "**3.4.1 Signal generator**" through "**3.4.3 Load**".



**Figure 3-4. Basic Connection Diagram**

### 3.4.1 Signal generator

When using a high frequency of 100 kHz or higher, use a signal generator with an output impedance of 50  $\Omega$  and set the input impedance of the BA4825 to 50  $\Omega$ .

When the output impedance of a signal generator is not 0  $\Omega$  but 50  $\Omega$ , for example, the output voltage of the signal generator needs to be set considering the input impedance of the BA4825.

To obtain a necessary input voltage, set the voltage of the signal generator as follows:

$$\left( 1 + \frac{\text{Output impedance of signal generator}}{\text{Input impedance setting of BA4825}} \right) \text{Times}$$

\* With WF1947, an output voltage for an arbitrary load impedance (1  $\Omega$  to 10k  $\Omega$ ) can be set.

### 3.4.2 Signal cords

For an input cord, use a BNC cable.

For an output cord, similarly, attach a BNC connector near a load and use a BNC cable.

When a high frequency is used, maximum power may not be supplied to a load because the output voltage of the BA4825 is partly consumed due to the inductance of the wire. If a capacitive load is used, LC resonance can occur with the wire inductance, resulting in ringing. Run a wire along a route as short as possible.

To avoid these effects, the inductance needs to be reduced, taking the length, structure, and material of the wire into consideration.

If a single polyvinyl chloride wire is used, for example, the inductance is about  $1 \mu\text{H}/\text{m}$ , and the impedance is about  $6.3 \Omega$  at 1 MHz.

### 3.4.3 Load

Attach a BNC connector near a load, and make a connection by using a BNC cable.

Place a load as close to the BA4825 as possible.

### 3.5 Examples of Basic Operations

#### 3.5.1 Input selection and input impedance selection

Connect the output signal of the signal generator to input connector A or B through a BNC cable.

Press input signal switch key A or B (INPUT key) connected to input connector A or input connector B, then select 50  $\Omega$  or 10 k $\Omega$  with the input impedance switch key (Zin key).

---

**⚠ CAUTION**

The BA4825 may be damaged if a voltage beyond the non-destructive maximum input voltage ( $\pm 11$  V) is applied.

Never apply a voltage beyond  $\pm 11$  V.

---

When a waveform produced by adding two signals is needed, connect the signal generator to both of input connectors A and B, then press both of the input signal switch keys A and B. Set an addition ratio by adjusting the level of the connected signal generator.

When the output impedance of the signal generator is not 0  $\Omega$  but 50  $\Omega$ , for example, set the output voltage of the BA4825 by considering the input impedance of the BA4825.

 Refer to "3.4 I/O Connection".

Note that even if the input signal switch key (INPUT key) or the input impedance switch key (Zin key) is pressed again before 1 second elapses after switching the input connector or input impedance, the input connector or the input impedance is not switched. To switch the input connector or input impedance in succession, insert a pause of at least 1 second.

#### 3.5.2 Voltage range selection

Set an optimum voltage range according to the output waveform used (symmetric waveform with identical positive and negative peak voltages, waveform superimposed on a positive direct current, or waveform superimposed on a negative direct current).

One of the following three voltage ranges can be selected by using the voltage range selection key (OUTPUT RANGE(V) key) on the front panel:

–250 V range: –250 V to +50 V

$\pm 150$  V range: –150 V to +150 V

+250 V range: –50 V to +250 V



### 3.5.3 Output voltage adjustment

A gain in the  $\times 1$  to  $\times 150$  range can be set by using the gain switch keys (GAIN keys),  $\times 1$ ,  $\times 10$ ,  $\times 20$ , and  $\times 50$ , and the control for fine adjustment (VAR) on the front panel.

To obtain a maximum output voltage of 100 Vrms, the signal generator needs to generate an output voltage of at least 0.67 Vrms (gain 150 times)

Note that the gain is not switched even if a gain switch key (GAIN key) is pressed again before 1 second elapses after switching the gain. To switch the gain in succession, insert a pause of at least 1 second.

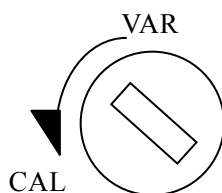

**Figure 3-5. CAL Position of Control for Fine Adjustment (VAR)**

### 3.5.4 Fine output offset adjustment

If trouble occurs because a direct current component is superimposed on the signal due to inductance, make a fine adjustment to set the offset voltage included in the output signal of the BA4825 to zero. Use the following procedure for fine offset voltage adjustment:

1. The output offset voltage varies depending on the gain setting, so set an output gain firstly.
2. Disconnect the input cord from the input connector.
3. Select the input to which the signal generator is connected by using the corresponding INPUT key.
4. Use the input impedance to  $50\ \Omega$  or  $10\ \text{k}\Omega$  by using the Zin key.
5. Connect a DC voltmeter (such as a digital voltmeter) to the output connector.
6. Adjust the DC output voltage to zero by using the potentiometer (OFFSET on the front panel) for fine offset tuning.

Perform fine output offset adjustment after setting the output on/off switch (OUTPUT) to ON.

Before performing fine offset adjustment, wait for 30 minutes to 1 hour until the initial drift is stabilized after power-on.

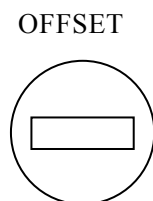

**Figure 3-6. Center Position of Offset Fine Adjustment**

### 3.5.5 DC bias addition

The BA4825 can add a DC voltage onto an output voltage signal for output.

For this setting, set the bias key (BIAS key) to ON and use the bias dial. A bias voltage beyond  $\pm 200$  V but not exceeding the maximum output value of a selected output range can be set.

An added voltage can be monitored on the output meter, if the input level is zero.

The relationship between a dial scale mark and output bias voltage can be calculated as indicated below.

The polarity of a DC bias is not switched by the output polarity switch key (INVT key).

$$\text{Bias output voltage} = (\text{Set scale mark} - 5.00) \times 43 \text{ Vdc}$$

Note that the bias on/off state is not switched even if the bias key (BIAS key) is pressed again before 1 second elapses after switching the bias on/off state. To switch the bias on/off state in succession, insert a pause of at least 1 second.

---

—  **CAUTION** —

The overload LED (OVLD) is turned on, if an output voltage exceeds the set output voltage range. When adding a DC bias, ensure that the waveform does not clip, taking the set output voltage range into consideration.

---

### 3.5.6 Output polarity switching

The output polarity can be set to be in-phase or reversed-phase by using the output polarity switch key (INVT key) on the front panel.

The LED on the output polarity switch key (INVT key) is turned on when the output polarity is in reversed phase.

Note that the output polarity is not switched, even if the output polarity switch key (INVT key) is pressed again before 1 second elapses after switching the output polarity. Insert a pause of at least 1 second to switch the output polarity in succession.

### 3.5.7 Output voltage monitoring

An output voltage can be monitored by using the monitor output connector on the rear panel and the output meter on the front panel.

- **Monitor output connector**

An output waveform can be observed by connecting an oscilloscope directly.

A waveform is output on the monitor output connector, regardless of the output on/off setting. A voltage with the level corresponding to 1/100 of the main output level is output.

- **Output meter**

The output meter is calibrated so that an RMS value is shown for a sine wave according to the full-wave rectified average detection method. An absolute value is shown for a direct current, so that the meter indicator deflects in the same direction, regardless of the polarity (+ or -).

An average value is shown when an alternate current is superimposed on a direct current. Examples are provided below.

- When a sine wave of 5 V<sub>rms</sub> is superimposed on a direct current of +10 V: 10 V is shown.
- When the direct current level is zero, and a sine wave of 5 V<sub>rms</sub> is given: 5 V is shown.

The meter switch key (METER key) on the front panel is used for switching between voltage and current. The output meter status LED (V, I) for a selection made is turned on.

A polarity is shown by a meter polarity LED. The meter polarity LED for "+" turns on when about +1 V or higher is output. The LED for "-" turns on when about -1 V or lower is output. Neither LED is turned on for -1 V to +1 V. Both LEDs are turned on for an AC output voltage. The LEDs turn on alternately for a low frequency.

The frequency characteristics for voltage measurement on the output meter are: DC to 1 MHz, within  $\pm 10\%$  of the full scale.

The frequency characteristics for current measurement are: DC to 100 kHz, within  $\pm 10\%$  of the full scale. For a frequency of 100 kHz or higher, the meter indicator can deflect due to a leakage to the internal circuitry. Greater leakage to the internal circuitry occurs as the frequency rises and the output voltage strengthens.

### 3.5.8 Output on/off control

The main output signal can be turned on or off by using the output on/off switch (OUTPUT) on the front panel or external control input. When external control is used, however, the output on/off switch (OUTPUT) can only be set to OFF.

The LED in the output on/off switch (OUTPUT) turns on when output is turned on.

The LED blinks when output is turned off by the protection function of the BA4825.

For protection cancellation, press the output on/off switch (OUTPUT).

When output is turned off, an attempt to turn on output can be accepted only after 2 seconds elapse for safety.

To turn on output again, wait for at least 2 seconds after output is turned off.

A relay contact is used to turn on and off output. To protect the relay circuit, a muting circuit is actuated at the time of output on/off switching, so that the monitor output and output meter indicate zero for a very short period.

When output overcurrent, excessive internal power loss, abnormal internal temperature, or output overvoltage is detected, the protection function activates and the overload LED turns on.

When the overload LED is on, output cannot be turned on.

When output overvoltage is detected while output is on, output is turned off.

For other overload factors, output turns off when overload lasts 10 seconds or more.

---

#### CAUTION

A high voltage can occur at the load when output is turned off if a load including an inductance component is connected, so be careful not to change the load current abruptly.

---

## 3.6 Setting at Power-on

Initial values for start-up time can be set by using the DIP switch on the rear panel.

"Table 3-2 List of DIP Switch Settings" indicates the function of each switch. Refer to each section indicated in the column "Section to be referenced" for setting details.

### 3.6 Setting at Power-on

**Table 3-2. List of DIP Switch Settings**

No.	Function			Section to be referenced
1	Output on/off			☞ 3.5.8 Output on/off control
	DOWN	Output on		
	UP	Output off		
2, 3	Output voltage gain setting			☞ 3.5.3 Output voltage adjustment
	2	3	Gain	
	UP	UP	×1	
	DOWN	UP	×10	
	UP	DOWN	×20	
4	External control on/off			☞ 3.3.4 External control I/O
	DOWN	External control on		
	UP	External control off		
5	Output polarity inversion on/off			☞ 3.5.6 Output polarity switching
	DOWN	Output polarity inversion on		
	UP	Output polarity inversion off		
6	Input on/off from input connector A			☞ 3.5.1 Input selection and input impedance selection
	DOWN	A input on		
	UP	A input off		
7	Input on/off from input connector B			☞ 3.5.1 Input selection and input impedance selection
	DOWN	B input on		
	UP	B input off		
8	Input impedance setting			☞ 3.5.1 Input selection and input impedance selection.
	DOWN	50 Ω		
	UP	10 kΩ		
9	DC bias on/off			☞ 3.5.5 DC bias addition
	DOWN	DC bias on		
	UP	DC bias off		
10	Meter indication setting			☞ 3.5.7 Output voltage monitoring
	DOWN	Current (I)		
	UP	Voltage (V)		
11, 12	Output range setting			☞ 3.5.2 Voltage range selection
	11	12	Output range	
	UP	UP	±150 V range	
	DOWN	DOWN		
	DOWN	UP	+250 V range	
UP	DOWN	-250 V range		



## 4. ADVANCED OPERATIONS

- 4.1 Maximum Output Current and Operation Range..... 4-2
- 4.2 Increasing of Output ..... 4-5

## 4.1 Maximum Output Current and Operation Range

The BA4825 has a protection circuit that detects an output current and internal loss to limit the output current. A maximum output current is determined by this protection circuit. This limitation value varies, depending on the output time and output voltage. The relationships are shown in "Figure 4-1 Operation Range (-50 V to +250 V range)" through "Figure 4-3 Operation Range (-250 V to +50 V range)".

Each graph shows an AC (within 15 ms) peak value range and a DC (15 ms or more) range.

In general, if the load is resistive for an AC signal, quadrants I and III make up an operation range. If the load is capacitive or inductive, all quadrants make up an operation range.

If the load involves an electromotive force with a DC signal, and an operation is performed to supply current from the load, quadrants II and IV make up an operation range.

For square wave input, when waveform rise/fall is fast, even if a lower frequency (period) is used, the output current protection range may be reached by a charge current for a load capacitance, output cable capacitance, or floating capacitance inside the BA4825, resulting in overload. In this case, decrease output voltage or slow the waveform rise/fall by using a signal generator (e.g., WF1947) that is capable of controlling waveform rise/fall.

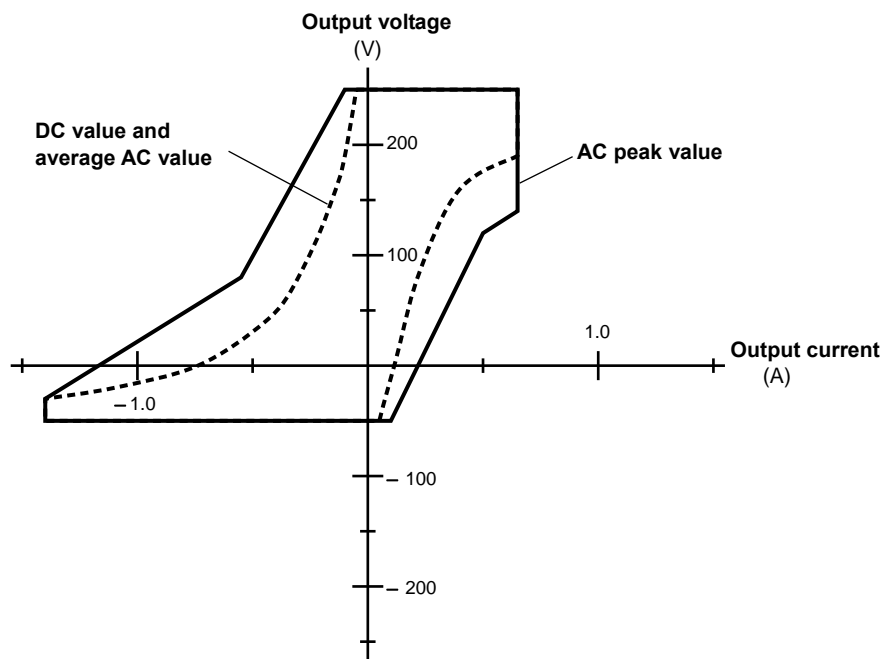

Figure 4-1. Operation Range (-50 V to +250 V range)



## 4.1 Maximum Output Current and Operation Range

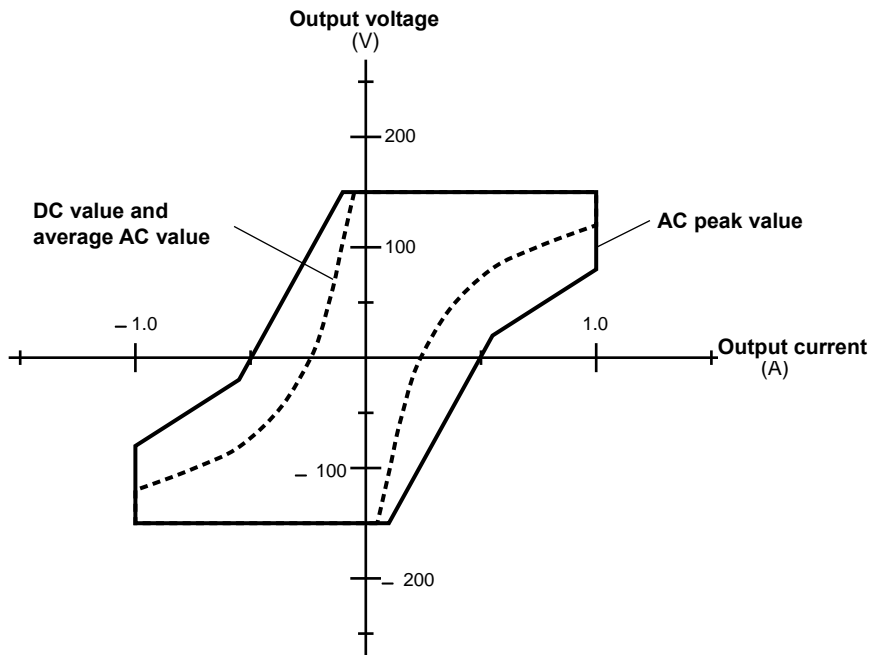

Figure 4-2. Operation Range ( $\pm 150$  V range)

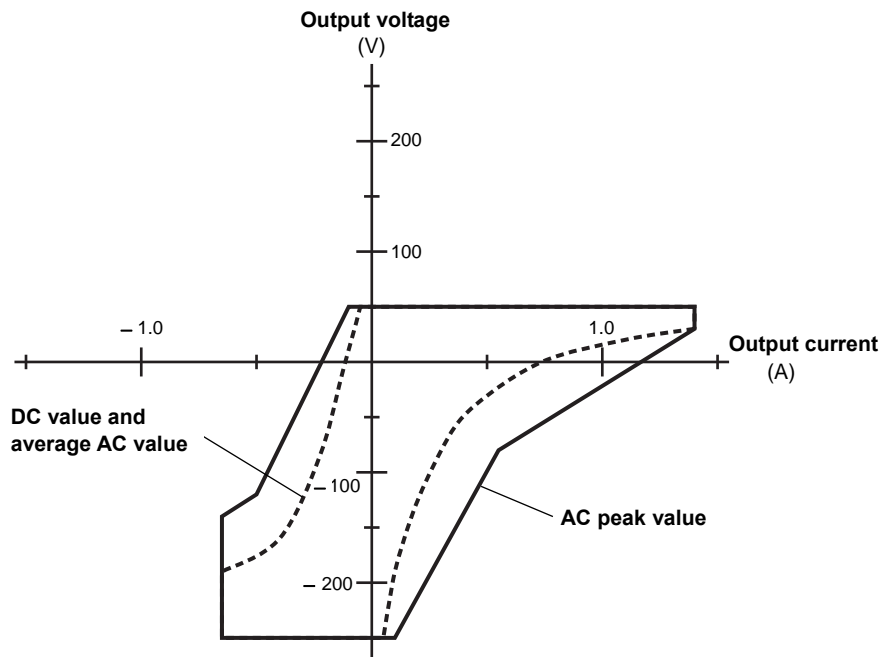

Figure 4-3. Operation Range (-250 V to +50 V range)

## 4.1 Maximum Output Current and Operation Range

Shown below is an operation range in the case where the signal waveform is asymmetric with regard to polarity and a direct current is generated.

When a waveform as shown in "**Figure 4-4 Current Waveform Asymmetric with Regard to Polarity**" is given, separate the positive portion and negative portion from each other and consider the average value (+Iave) and peak value (+Ipk) on the positive side, and consider the average value (-Iave) and peak value (-Ipk) on the negative side.

The average values (+Iave, -Iave) and peak values (+Ipk, -Ipk) are limited by the DC operation limitation range and AC peak operation limitation range, respectively.

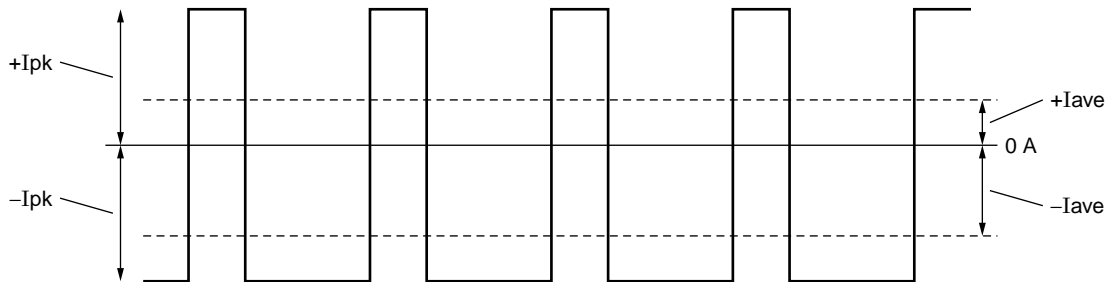

**Figure 4-4. Current Waveform Asymmetric with Regard to Polarity**

## 4.2 Increasing of Output

The output voltage and output power can be doubled by using two BA4825 units. The output current remains unchanged from the current output when one BA4825 unit is used. Be sure to use the same type of high-speed bipolar amplifier. Moreover, use a frequency of 100 kHz or lower.

As shown in "Figure 4-5 Connection of Two BA4825 Units", divide the output of a signal generator with a T-type divider for connection to the input connector (A or B) of each BA4825 unit.

Set the output polarity switch key (INVT key) on one BA4825 unit to INVT so that the output phase is opposite to that of the other BA4825 unit. Set the input impedance to 10 k $\Omega$  on both BA4825 units. Set the same gain on both BA4825 units.

Connect a load between the outputs of the two BA4825 units as shown in "Figure 4-5 Connection of Two BA4825 Units". At this time, the connection terminal of a load cannot be connected to the BA4825 and the housing of the signal generator. When a load is used in this mode of connection, the load must therefore be insulated from the ground potential and signal source.

Note that the polarity remains unchanged even when the bias is set to the reversed phase (INVT).

---

### ⚠ CAUTION

Insulate the load from the ground potential and signal source.

---

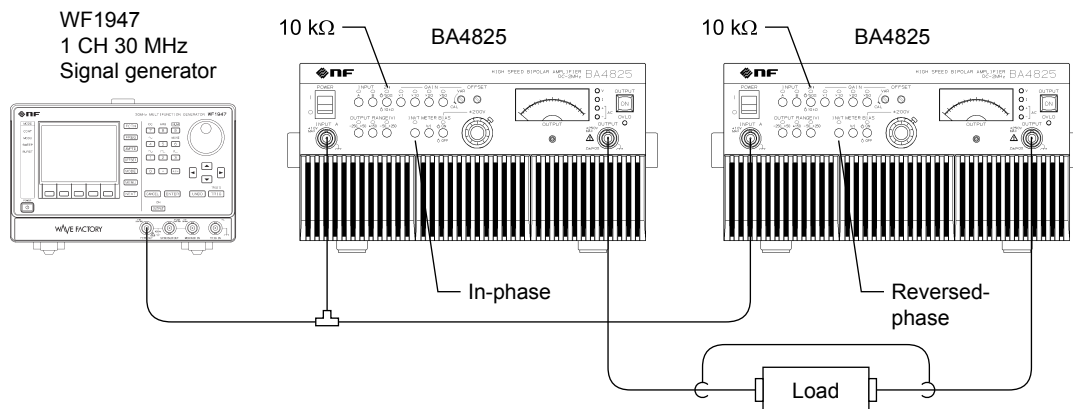

Figure 4-5. Connection of Two BA4825 Units



# 5. TROUBLESHOOTING

5.1	Error Messages .....	5-2
5.1.1	Errors at Power-on .....	5-2
5.1.2	Errors related to the protection function .....	5-3
5.2	When Fault Symptoms Are Observed .....	5-5

## 5.1 Error Messages

Self-diagnosis is performed when the power is turned on. If an error is detected, the error state is set. The error state is also set when a wrong operation is performed.

Errors and their causes are described below, together with required actions.

### 5.1.1 Errors at Power-on

The BA4825 performs self-diagnosis when the power is turned on.

If an abnormality is found, contact NF Corporation or its representative.

**Table 5-1. Diagnosis Performed at Power-on**

Diagnosis item	Description
LED glow check	Visually check that all LEDs glow for about 1 second. At this time, however, the following LEDs do not glow on: <ul style="list-style-type: none"> <li>• Output on/off switch (OUTPUT)</li> <li>• AC+ and AC- LEDs for meter polarity (which may be turned on because these LEDs are undefined)</li> </ul>
ROM sum check	Check whether the ROM is normal. If an abnormality is detected, the BA4825 cannot be operated.

**5.1.2 Errors related to the protection function**

The errors related to the protection function are shown below.

Contact NF Corporation or its representative if an abnormality is found.

**Table 5-2. Errors Related to Protection Function (1/2)**

State	Cause	Description
Overload	Output exceeded the allowable output voltage/current range of the BA4825.	The overload LED (OVLD) is on. Output cannot be turned on in the overload state.
		If the overload state lasts for 10 seconds, output is turned off and the LED in the output on/off switch (OUTPUT) then blinks. The overload state can be reset by pressing the output on/off switch.
		If the overload state lasts for 60 seconds, a transition is made to sleep operation, and the overload LED (OVLD) blinks. The BA4825 cannot be operated in sleep operation, so turn off the power.
		If the overload LED (OVLD) is on even when the input signal, bias, and output are off, the BA4825 may have failed.
Abnormal temperature	The internal temperature is abnormally high.	The overload LED (OVLD) is on. Output cannot be turned on when the temperature is abnormal.
		Output is turned off if the abnormal temperature state lasts for 10 seconds. The LED in the output on/off switch (OUTPUT) blinks at this time. The abnormal temperature state can be reset by pressing the output on/off switch.
		If the abnormal temperature state lasts for 60 seconds, a transition is made to sleep operation, and the overload LED (OVLD) blinks. The BA4825 cannot be operated in sleep operation, so turn off the power.
		If the overload LED (OVLD) is on even when the input signal, bias, and output are off, and the ambient temperature satisfies the specification, the BA4825 may have failed.

## 5.1 Error Messages

**Table 5-3. Errors Related to Protection Function (2/2)**

State	Cause	Description
Abnormal output voltage	Output voltage or voltage applied to the output terminal is an overvoltage.	<p>The overload LED (OVLD) is on. Output cannot be turned on when the output voltage is abnormal. Output is turned off immediately if an abnormal output voltage is detected when output is turned on. The LED in the output on/off switch (OUTPUT) blinks at this time.</p> <p>A transition is made to sleep operation, and the overload LED (OVLD) blinks if the abnormal output voltage state lasts for 60 seconds. The BA4825 cannot be operated in sleep operation, so turn off the power. If the overload LED (OVLD) is on even when the input signal, bias, and output are off, the BA4825 may have failed.</p>
Internal power supply abnormality	Voltage of amplifier DC power supply (internal power supply) is lower than specification.	<p>Every voltage range (OUTPUT RANGE) LED blinks. At power-on, blinking stops after approximately 3 seconds. Operations other than power-off are disabled while the LEDs are blinking. Turn off the power, and then turn it on again. If the LEDs keep blinking, the BA4825 may have failed.</p>



## 5.2 When Fault Symptoms Are Observed

When a fault symptom shown below is observed, perform the corresponding action required. Contact NF Corporation or its representative if the symptom cannot be corrected.

**Table 5-4. When Fault Symptoms Are Observed (1/2)**

Symptom	Possible cause	Action required
The BA4825 does not operate when the power switch is turned on.	The BA4825 is not connected to a live power.	Securely connect the power cord to a live power outlet and to the inlet of the BA4825.
There is no output.	Signal not connected.	Connect the signal generator and correctly select an input signal selection key.
	Input selection not made.	
	The output on/off switch (OUTPUT) is not set to ON.	Set the output on/off switch to ON.
	The output on/off switch (OUTPUT) cannot be set to ON.	Output cannot be turned off when the overload LED (OVL D) is turned on. Release the condition for turning on the overload LED referring to the required action shown in " <b>Table 5-2 Errors Related to Protection Function (1/2)</b> " for a case where the overload LED (OVL D) is turned on. When the overload LED (OVL D) is blinking, all key operations are disabled. Turn off the power switch. Release the condition for blinking the overload LED then turn on the power switch referring to the required action shown in " <b>Table 5-2 Errors Related to Protection Function (1/2)</b> " for a case where the overload LED (OVL D) blinks.
The output voltage waveform is distorted when the overload LED (OVL D) is off.	AC peak current protection is working.	Overload occurs.If you drive a capacitive load with square wave, the output current flows more when the output voltage waveform rises or falls than when it is steady. Lower the load within the maximum output current (AC peak value) referring to " <b>4.1 Maximum Output Current and Operation Range</b> " or slow the rise time or fall time of the input signal or lower the input signal (output voltage).
Overload occurs when the input signal is a square wave, even if with no load.	Since the input signal quickly rises and falls, the current that is charged to the floating capacitance in the BA4825 reaches the protection level.	Lower the input signal (output voltage) or use a signal generator, such as the NF WF1947, that controls the rise and fall of waveforms to decrease the rise and fall time.

## 5.2 When Fault Symptoms Are Observed

**Table 5-5. When Fault Symptoms Are Observed (2/2)**

Symptom	Possible cause	Action required
The overload LED (OVLD) is on.	An overload is imposed.	If the overload LED is turned off by removing the load, connect a load within the maximum allowable output range or reduce the output level.
	The signal level of the signal generator is excessively high.	Lower the level of the connected signal generator.
	An incorrect gain setting is made.	Set a proper gain by using a gain switch key (GAIN key).
	The ambient temperature is high.	When using the BA4825, ensure that the ambient temperature is 40°C or below.
	The air filters are clogged.	Referring to " <b>6.2 Daily Maintenance</b> ", clean the air filters.
	There is an obstacle to air circulation near the front panel air inlet or rear panel air outlet.	Install the BA4825 to satisfy the installation conditions described in " <b>2.2 Setup and Installation</b> ".
	A voltage beyond the maximum allowable output of each voltage range is output.	The input signal level may be too high. Lower the input signal level. When bias addition is on, lower the bias addition level.
Direct current is output.	Bias addition is set to ON.	Set bias addition to OFF with the bias key (BIAS key).
	A direct current is superimposed onto the signal source.	Adjust the DC component of the signal generator to zero.
The output on/off switch (OUTPUT) blinks and output is turned off even when the overload LED (OVLD) is not turned on.	The BA4825 has turned off output since the overload state has lasted for 10 seconds or more,.	An overload is imposed. Connect a load within the maximum allowable output range or reduce the output level.
	Protection against abnormal output voltage has been actuated.	Overcurrent protection may be actuated when an inductive load is connected, resulting in overvoltage output. Finely adjust the output offset voltage to zero, referring to " <b>3.5.4 Fine output offset adjustment</b> ".

# 6. MAINTENANCE

- 6.1 Introduction..... 6-2
- 6.2 Daily Maintenance ..... 6-3
- 6.3 Storage, Repacking, and Transportation..... 6-4
- 6.4 Performance Testing..... 6-5
  - 6.4.1 Measurement of maximum output voltage..... 6-6
  - 6.4.2 Measurement of maximum output power..... 6-7
  - 6.4.3 Measurement of frequency characteristics ..... 6-8
  - 6.4.4 Measurement of gain error ..... 6-10
  - 6.4.5 Measurement of sine wave distortion factor ..... 6-11
  - 6.4.6 Measurement of bias-added voltage ..... 6-12

### 6.1 Introduction

This chapter describes the following:

- Notes on long-term storage and the method of storage
- Notes on transportation and repacking for transportation
- Performance test required, for example, for preventive maintenance, acceptance testing, and performance confirmation after repair

See section "**2.4 Simplified Operation Check**" for simplified operation checking.

Contact NF Corporation for calibration or repair if an operation check or performance test cannot be made successfully.

## 6.2 Daily Maintenance

- When the panel or case surface is soiled

Wipe off stains with a soft cloth. Wipe resistant stains with a cloth that has been soaked in a neutral detergent solution and then wrung well.

Do not use a volatile solvent such as a thinner or benzene, or a chemical wipe, which may degrade the material quality or remove the paint.

- When the air filters of the fan are dirty

The air intake vent on the front panel has three air filters for removing dust and dirt from input air.

Dust and dirt adhering to the filters, if not removed, can clog the filters and reduce the air flow, causing the temperature inside the BA4825 to rise and lowering its reliability. Periodically check the air filters for dust and dirt. Clean the air filters monthly, in general, when a fine buildup of dust or dirt is observed on the filters.

If the air filters are dirty, remove the dust and dirt from the filters by washing them in water and reinstall the filters after completely drying them.

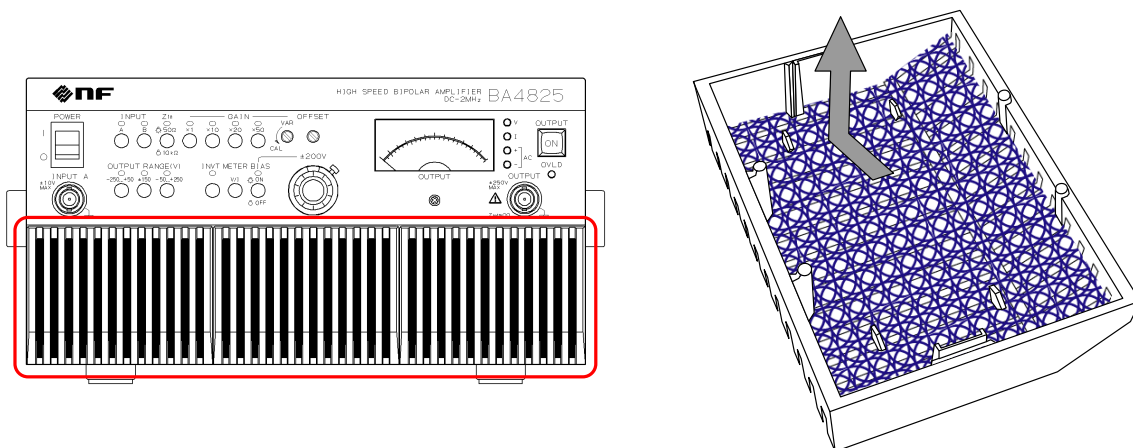

- (1) Push the right or left end of the intake vent on the front panel horizontally.
- (2) The hooks of the intake vent are disengaged from the main unit, so hold the left and right ends of the intake vent and pull it entirely toward you until it comes off the main unit.
- (3) Remove an air filter from the rear side of the intake vent and clean the filter.
- (4) Clean the other air filters, using the same procedure.
- (5) When the air filters have dried completely, reinstall the intake vent by reversing steps (1) through (3).

**Figure 6-1. Air Filter Cleaning Procedure**

The air filters will not function normally if the filters are soiled by very fine dust (fine powder) or clogged. Do not install the BA4825 in a place where the BA4825 is exposed to much dirt and dust (including fine powder) or the humidity is high and condensation can easily occur.

### 6.3 Storage, Repacking, and Transportation

- Long-term storage

- Disconnect the power cord from the power outlet and the main unit.
- Store the BA4825 in a place, e.g., on a shelf or rack, so that no object will fall on the BA4825 and the BA4825 will not be exposed to dust.

If the BA4825 may be exposed to dust, place a cloth or polyethylene cover on the BA4825.

- The environment conditions allowable for storage are:  $-10^{\circ}\text{C}$  to  $+50^{\circ}\text{C}$  and 5% to 95% RH. Avoid placing the BA4825 in a place that experiences steep temperature changes and is exposed to direct sunlight, and store the BA4825 at room temperature whenever possible.

- Repacking and transportation

Note the following when repacking the BA4825 for transportation or repair:

- Enclose the main unit with a polyethylene envelope or sheet.
- Prepare a corrugated cardboard box that can sufficiently withstand the weight of the main unit and is large enough.
- When repacking the BA4825, insert cushioning materials to protect the six faces of the main unit.
- When asking a carrier to transport the BA4825, notify the carrier that the BA4825 is a precision device.
- Be sure to include the instruction manual at transportation.

## 6.4 Performance Testing

Performance testing is conducted as part of preventive maintenance to prevent performance degradation of the BA4825. Performance testing is also conducted as part of acceptance inspection, periodic inspection, performance verification after repair, and so forth.

If the result of a performance testing does not meet the specifications, calibration or repair is required.

### WARNING

This product contains high-voltage parts. Never remove the cover.

All internal inspections of this product are to be performed only by service engineers qualified by NF Corporation.

- The following measuring instruments are used for performance testing.

Measuring instrument	Major performance	Recommendation
Signal generator	40 Hz to 2 MHz Sine wave, 20 Vp-p	WF1947 of NF Corporation
AC voltmeter	10 Hz to 2 MHz, 1 mV to 300 V	URE3 of Rohde & Schwarz
DC voltmeter	0 to $\pm 300$ V	
Frequency characteristics analyzer	10 Hz to 2 MHz	FRA5097 of NF Corporation
Oscilloscope	DC to 50 MHz, 10 mV to 300 V	GDS1072B of NF Corporation
Audio analyzer	40 Hz to 100 kHz, 0.1%FS	VP-7723D of Levear
Terminating resistor	200 $\Omega$ $\pm 1\%$ /allowing application of 50 W, and 150 $\Omega$ $\pm 5\%$ /allowing application of 150 W	

### CAUTION

- As a terminating resistor (200  $\Omega$ ), use a pure resistor with a minimum parallel capacitance and inductance component in the DC to 2 MHz range.
- For output wiring, use a BNC cable of 50  $\Omega$  not exceeding a total length of 50 cm.
- Be sure to use a 10:1 probe when connecting an oscilloscope.

- Check the items shown below before conducting a performance testing.

 See "3.5.4 Fine output offset" for the method of fine tuning.

- Check that the supply voltage range is 90 V AC to 250 V AC.
- Check that the ambient temperature is within the range 5°C to 35°C, and the ambient humidity is within the range 5% to 85% RH.
- Check that there is no condensation.
- Check that 30 minutes or more has elapsed after the power has been turned on.

### 6.4.1 Measurement of maximum output voltage

- Connection

Connect a signal generator, AC voltmeter, oscilloscope, and terminating resistor as shown in "Figure 6-2 Measurement of Maximum Output Voltage".

- Setting

Set the BA4825 as follows:

Item	Setting
Input switching	A
Input impedance	50 $\Omega$
Bias addition	OFF, dial 5.00
Polarity switching (INVERT)	OFF
Gain setting	$\times 50$ (CAL)
Voltage range	$\pm 150$ V range
Terminating resistor	200 $\Omega$

- Test procedure

<1> Set the waveform of the signal generator to sine wave, and set the frequencies shown in "Table 6-1 Judgment of BA4825 Performance".

<2> Set the output on/off switch of the BA4825 to ON.

<3> Increase the output voltage of the signal generator gradually from 0 V.

<4> Observe the waveform on the oscilloscope. Record the output voltage value when the waveform begins to be distorted or the overload LED (OVL D) begins to be glow.

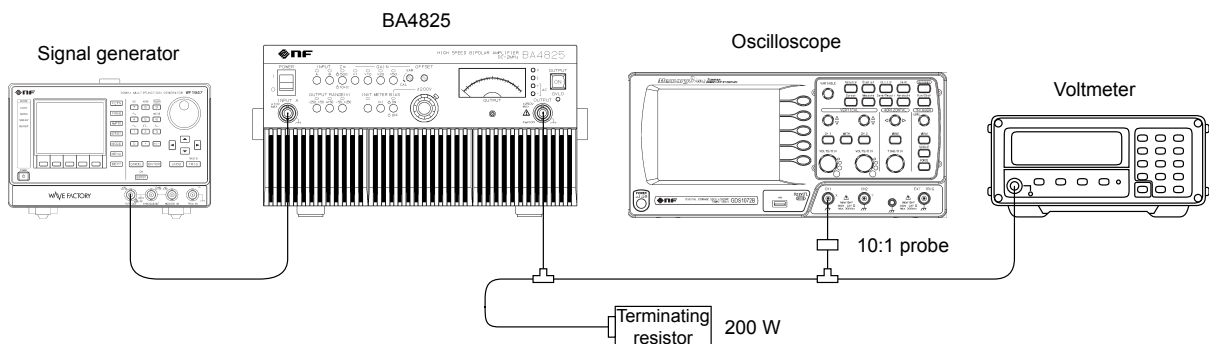

Figure 6-2. Measurement of Maximum Output Voltage



### 6.4.2 Measurement of maximum output power

- Connection

Connect a signal generator, DC voltmeter, and terminating resistor as shown in "Figure 6-3 Measurement of Maximum Output Power".

- Setting

Set the BA4825 as follows:

Item	Setting
Input switching	A
Input impedance	50 Ω
Bias addition	OFF, dial 5.00
Polarity switching (INVERT)	OFF
Gain setting	×50 (CAL)
Voltage range	±150 V range
Terminating resistor	150 Ω

- Test procedure

<1> Set the output on/off switch of the BA4825 to ON.

<2> Set bias addition to ON, and increase the dial gradually from 5.00.

<3> Record the output voltage value immediately before the overload LED (OVL) lights. A maximum output power value is obtained by conversion according to the formula  $(\text{output voltage})^2 \div (\text{terminating resistor value})$ .

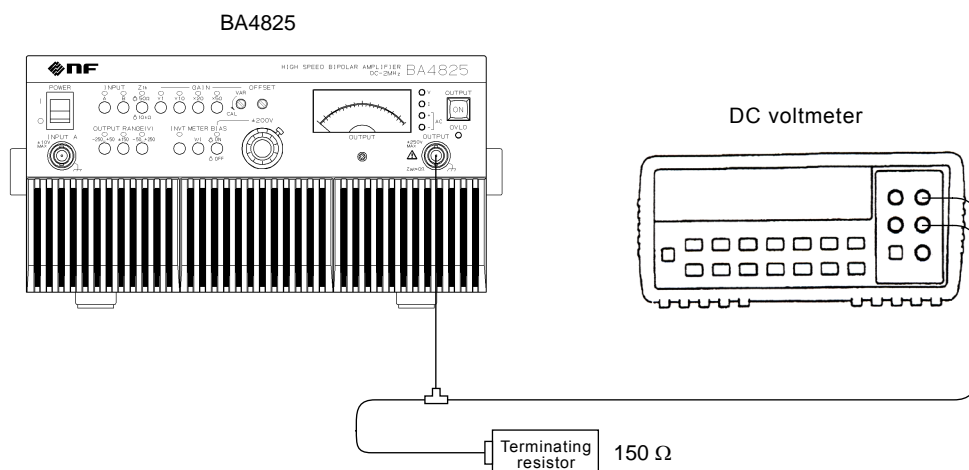

Figure 6-3. Measurement of Maximum Output Power

### 6.4.3 Measurement of frequency characteristics

- Connection

Connect an FRA5097 frequency response analyzer (FRA) and terminating resistor as shown in "Figure 6-4 Measurement of Frequency Characteristics".

- Setting

Set the BA4825 as follows:

Item	Setting
Input switching	A
Input impedance	50 $\Omega$
Bias addition	OFF, dial 5.00
Polarity switching (INVERT)	OFF
Gain setting	$\times 50$ (CAL)
Voltage range	$\pm 150$ V range
Terminating resistor	200 $\Omega$

Set the FRA as follows:

Item	Setting
Output	Sine wave 1.13 V <sub>peak</sub>
Sweep frequency	100 Hz to 2 MHz, log sweep
Analysis	ch1/ch2
Indication	logF–logR– $\theta$

- Test procedure

<1> Turn on FRA output.

<2> Perform UP (or DOWN) sweep operation for measurement at 100 MHz to 2 MHz.

<3> Move the cursor after measurement to read the gains at 1 kHz, 100 kHz, 500 kHz, and 2 MHz.

## 6.4 Performance Testing

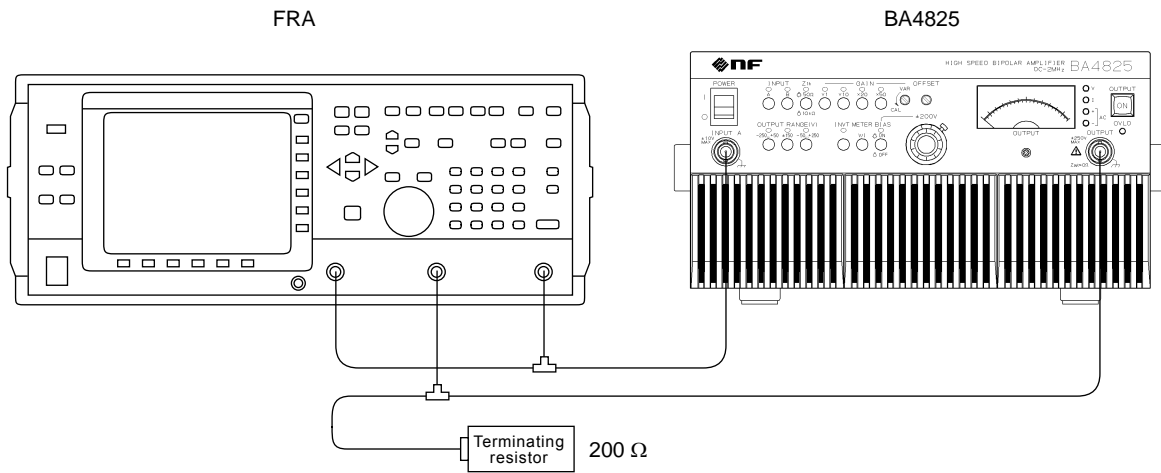

**Figure 6-4. Measurement of Frequency Characteristics**

### 6.4.4 Measurement of gain error

- Connection

Connect an FRA and terminating resistor as shown in "**Figure 6-4 Measurement of Frequency Characteristics**".

- Setting

Set the BA4825 as follows:

Item	Setting
Input switching	A
Input impedance	50 $\Omega$
Bias addition	OFF, dial 5.00
Polarity switching (INVERT)	OFF
Gain setting	$\times 50$ (CAL)
Voltage range	$\pm 150$ V range
Terminating resistor	200 $\Omega$

Set the FRA as follows:

Item	Setting
Output	Sine wave
Frequency	1 kHz
Analysis	ch1/ch2
Indication	logF-R- $\theta$

- Test procedure

<1> Set the gain of the BA4825 and the output voltage of the FRA as shown in "**Table 6-1 Judgment of BA4825 Performance**".

<2> Turn on FRA output.

<3> Make a measurement in the continuous mode.

### 6.4.5 Measurement of sine wave distortion factor

- Connection

Connect an audio analyzer and terminating resistor as shown in "Figure 6-5 Measurement of Sine Wave Distortion Factor".

- Setting

Set the BA4825 as follows:

Item	Setting
Input switching	A
Input impedance	50 $\Omega$
Bias addition	OFF, dial 5.00
Polarity switching (INVERT)	OFF
Gain setting	$\times 50$ (CAL)
Voltage range	$\pm 150$ V range
Terminating resistor	200 $\Omega$

- Test procedure

<1> Adjust the output level of the audio analyzer so that the output voltage of the BA4825 is 80 Vrms.

<2> Measure the sine wave distortion factors at frequencies of 40 Hz, 1 kHz, and 100 kHz.

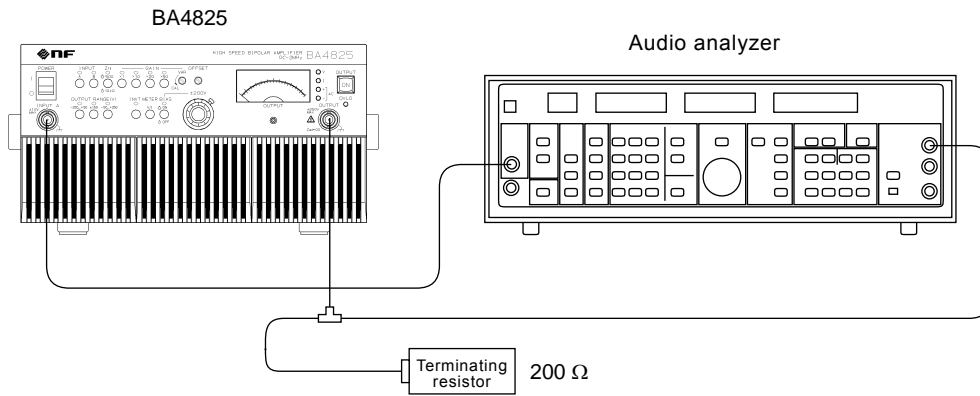

Figure 6-5. Measurement of Sine Wave Distortion Factor

### 6.4.6 Measurement of bias-added voltage

- Connection

Connect a DC voltmeter and terminating resistor as shown in "Figure 6-6 Measurement of Bias-Added Voltage".

- Setting

Set the BA4825 as follows:

Item	Setting
Input switching	OFF for both of A and B
Input impedance	50 Ω
Bias addition	OFF, dial 5.00
Polarity switching (INVERT)	OFF
Gain setting	×50 (CAL)
Voltage range	±150 V range
Terminating resistor	200 Ω

- Test procedure

- <1> Before starting a measurement, adjust the offset voltage of the BA4825 to zero according to "3.5.4 Fine output offset adjustment".
- <2> Set bias addition of the BA4825 to ON and change the dial gradually from 5.00.
- <3> Measure the output voltages at scale marks of 1.50 and 8.50.
- <4> After a measurement, set bias addition to OFF and set the dial to 5.00 for safety.

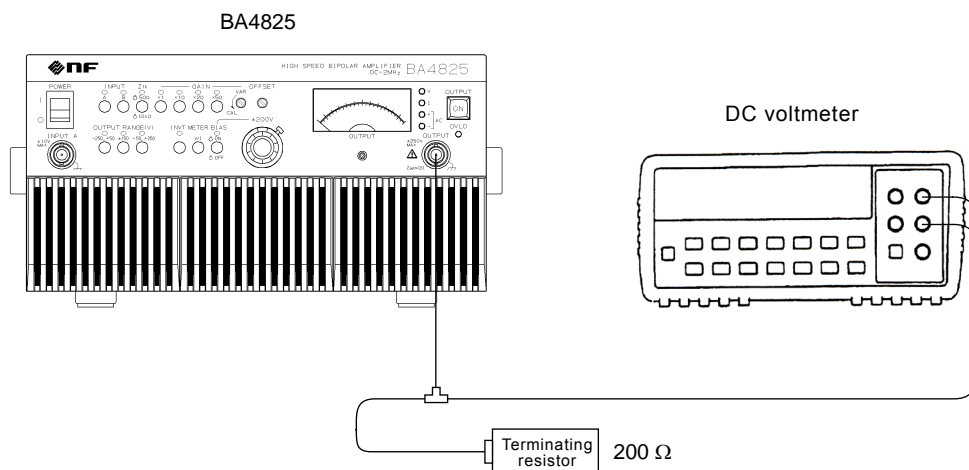

Figure 6-6. Measurement of Bias-Added Voltage

## 6.4 Performance Testing

The performance of the BA4825 is normal if the following criteria are satisfied:

**Table 6-1. Judgment of BA4825 Performance**

Measurement of maximum output voltage (at 40 Hz, 1 kHz, 500 kHz, and 2 MHz)	Set frequency	Criterion	Measured value	Judgment
	40 Hz	100 Vrms or more	__ . __	Pass/Fail
	1 kHz	100 Vrms or more	__ . __	Pass/Fail
	500 kHz	100 Vrms or more	__ . __	Pass/Fail
	2 MHz	40 Vrms or more	__ . __	Pass/Fail

Measurement of maximum output power [Voltage immediately before the overload LED (OVLD) is turned on]	Frequency	Terminating resistor	Criterion	Measured value	Judgment
	DC	150 $\Omega$	150 V or more	__ . __	Pass/Fail

Measurement of frequency characteristics (at 100 kHz, 500 kHz, and 2 MHz with the value at 1 kHz used as a reference (0 dB))	Set frequency	Criterion	Measured value	Judgment
	1 kHz	0 dB (reference)	0 . 00	Used as reference
	100 kHz	-0.5 to +0.5 dB	__ . __	Pass/Fail
	500 kHz	-3.0 to +1.0 dB	__ . __	Pass/Fail
	2 MHz	-3.0 to +1.0 dB	__ . __	Pass/Fail

Measurement of gain error At Gain $\times 1$ (CAL), $\times 10$ (CAL), $\times 20$ (CAL), $\times 50$ (CAL)	Gain setting	FRA output voltage	Criterion	Measured value	Judgment
	$\times 1$ (CAL)	10 V <sub>peak</sub>	0.95 to 1.05	__ . __	Pass/Fail
	$\times 10$ (CAL)	10 V <sub>peak</sub>	9.5 to 10.5	__ . __	Pass/Fail
	$\times 20$ (CAL)	10 V <sub>peak</sub>	19.0 to 21.0	__ . __	Pass/Fail
	$\times 50$ (CAL)	5.65 V <sub>peak</sub>	47.5 to 52.5	__ . __	Pass/Fail

Measurement of sine wave distortion factor (at each frequency)	Set frequency	Criterion	Measured value	Judgment
	40 Hz	0 to 0.1%	0 . __ __	Pass/Fail
	1 kHz	0 to 0.1%	0 . __ __	Pass/Fail
	100 kHz	0 to 1.0%	__ . __ __	Pass/Fail

Measurement of bias-added voltage (at each dial scale mark)	Dial setting	Criterion	Measured value	Judgment
	1.50	About -150 V	-__ __ . __	Pass/Fail
	8.50	About +150 V	+__ __ . __	Pass/Fail





## 7. SPECIFICATIONS

7.1	Input	7-2
7.2	Output	7-3
7.3	Monitor Output	7-8
7.4	Protection Function	7-8
7.5	External Control I/O	7-9
7.6	Output On/Off Control	7-9
7.7	Setting at Power-on	7-10
7.8	Power Input	7-10
7.9	Safety and EMC	7-10
7.10	Ambient Temperature Range, Ambient Humidity Range, Etc.	7-11
7.11	External Dimensions and Weight	7-12

**Values that indicate accuracy are guaranteed values, but values that do not indicate accuracy are nominal or typical (typ.) values.**

Unless otherwise noted, the following conditions are adopted:

Power input:	100 V AC, 50 Hz
Output frequency:	1 kHz
Output waveform:	Sine wave
Output voltage, current:	100 Vrms, 0.5 Arms
Output polarity:	In-phase
Load:	Resistance 200 $\Omega$ (power factor 1, nominal value)
Input impedance:	50 $\Omega$
Gain setting:	$\times 50$ (CAL)
Output voltage range:	$\pm 150$ V range

## 7.1 Input

### ■ Input mode

Input A, input B, or addition of input A and input B (when the two inputs are on, provided that the maximum total voltage of the two inputs is within  $\pm 10$  V)

### ■ Input impedance

Switchable between 50  $\Omega$  and 10 k $\Omega$  (unbalance, in the case of simultaneous input of A and B)

### ■ Maximum input voltage

$\pm 10$  V

### ■ Non-destructive maximum input voltage

$\pm 11$  V

### ■ Input terminal

BNC connector

Number of pins: 2

Input A: Front panel, Input B: Rear panel

The Lo side is connected to the housing.

## 7.2 Output

- Operation mode

Constant voltage (CV)

- Output polarity

In-phase or reversed-phase (switchable with the switch on the panel)

- Output range

One of the following three ranges can be selected:

–250 V range: –250 V to +50 V

±150 V range: –150 V to +150 V

+250 V range: –50 V to +250 V

- Gain setting function

Fixed: ×1, ×10, ×20, ×50

Variable: ×1 (CAL) to ×3 continuous

A set gain is (fixed) × (variable).

- Gain error

±5% (Gain adjustment: CAL, at 1 kHz)

- Maximum output voltage

±150 V range: Resistance load 200 Ω

100 Vrms or more	40 Hz to 500 kHz
------------------	------------------

70 Vrms or more	500 kHz to 1 MHz
-----------------	------------------

40 Vrms or more	1 MHz to 2 MHz
-----------------	----------------

±150 V range: Resistance load 450 Ω

±150 V (300 Vp-p)	DC to 500 kHz
-------------------	---------------

±100 V (200 Vp-p)	500 kHz to 1 MHz
-------------------	------------------

±56 V (112 Vp-p)	1 MHz to 2 MHz
------------------	----------------

+250 V range: Resistance load 1250 Ω

–50 V to +250 V	DC to 500 kHz
-----------------	---------------

+40 V to +240 V	500 kHz to 1 MHz
-----------------	------------------

+80 V to +200 V	1 MHz to 2 MHz
-----------------	----------------

–250 V range: Resistance load 1250 Ω

–250 V to +50 V	DC to 500 kHz
-----------------	---------------

–240 V to –40 V	500 kHz to 1 MHz
-----------------	------------------

–200 V to –80 V	1 MHz to 2 MHz
-----------------	----------------

- Output voltage and current ranges

 See "Figure 7-1 Output Voltage/Current Range (AC)" and "Figure 7-2 Output Voltage/Current Range (DC)".

- Rated output current

0.5 Arms ( $\pm 150$  V range, resistance load  $200 \Omega$ )

- Rated output power

50 W

- Maximum output power

150 W (resistance load  $150 \Omega$ )

 See "Figure 7-1 Output Voltage/Current Range (AC)" and "Figure 7-2 Output Voltage/Current Range (DC)".

- Small-amplitude frequency characteristics

Condition: Output amplitude 20 Vrms, 1 kHz used as a reference

DC to 100 kHz  $\pm 0.5$  dB

100 kHz to 2 MHz +1, -3 dB

- Rise/fall time

0.5  $\mu$ s or less (10% to 90% change, input square wave, output 40 Vp-p)

- Slew rate

500 V/ $\mu$ s or more (input square wave, output 200 Vp-p)

- Output DC offset

Adjustable range:  $\pm 0.5$  V or more (input terminal shorted)

Temperature drift: Within  $\pm(4+0.1 \times G)$  mV/ $^{\circ}$ C (typ.)

**NOTE** G represents a gain ( $G = 10$  in the case of  $\times 1$ )

- Output DC bias

$\pm 200$  V or more (provided that the maximum output value of the selected output range is not exceeded)

The switch on the front panel can be used to turn on and off output DC bias.

- Harmonic distortion factor

0.1% or less (40 Hz to 1 kHz, output 80 Vrms)

1% or less (1 kHz to 100 kHz, output 80 Vrms)

- Spurious

  - 30 dBc or less (100 kHz to 500 kHz, output 30 Vrms)

  - 25 dBc or less (500 kHz to 2 MHz, output 30 Vrms)

- Output noise

  - Condition: Input terminal shorted, measurement band 10 Hz to 1 MHz

  - 50 mVrms or less

- Output impedance

  - $0.5 \Omega + 1.5 \mu\text{H}$  (typ.)

- Output terminal

  - BNC connector (front panel)

  - The Lo side is connected to the housing.

## 7.2 Output

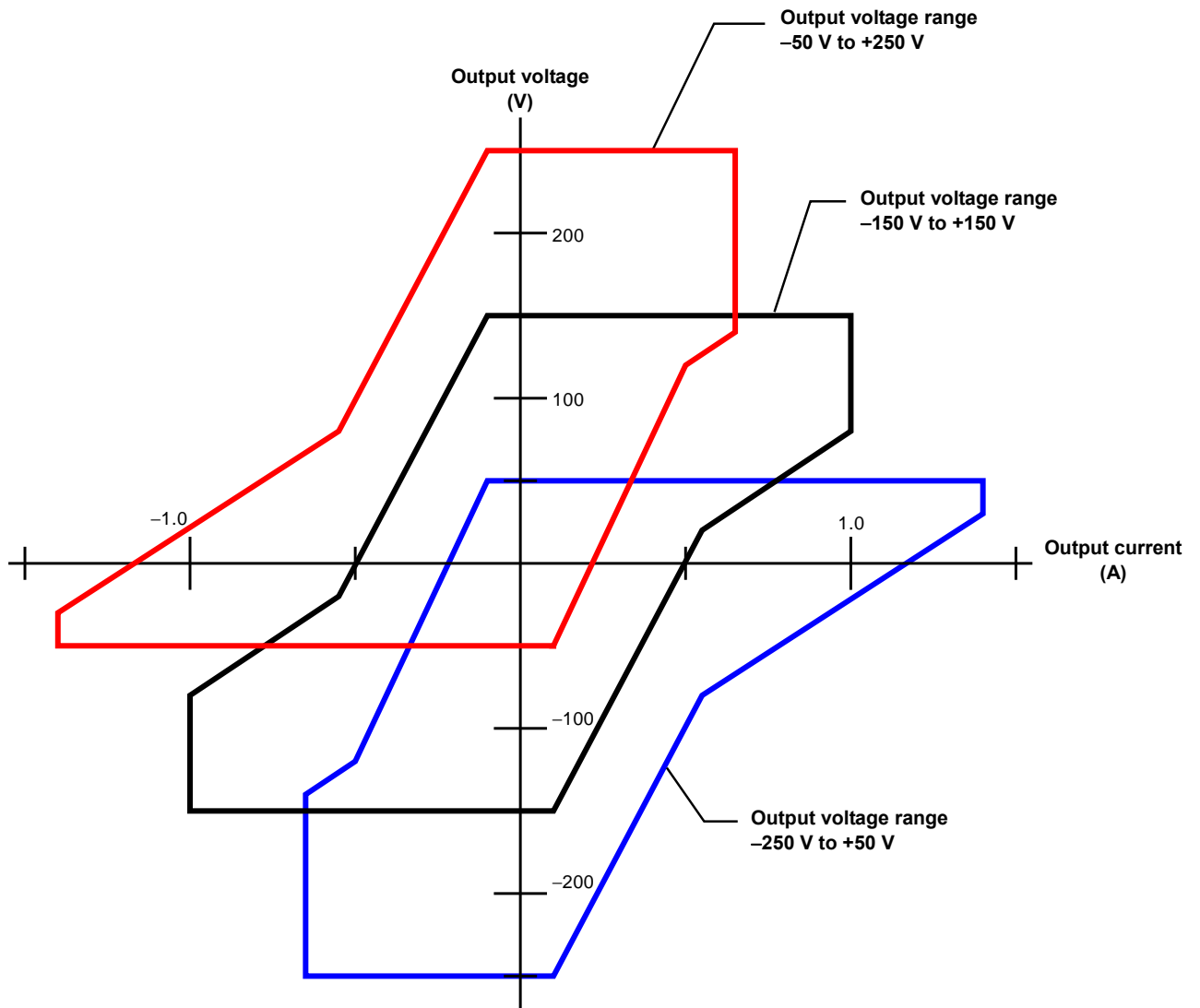

Figure 7-1. Output Voltage/Current Range (AC)

## 7.2 Output

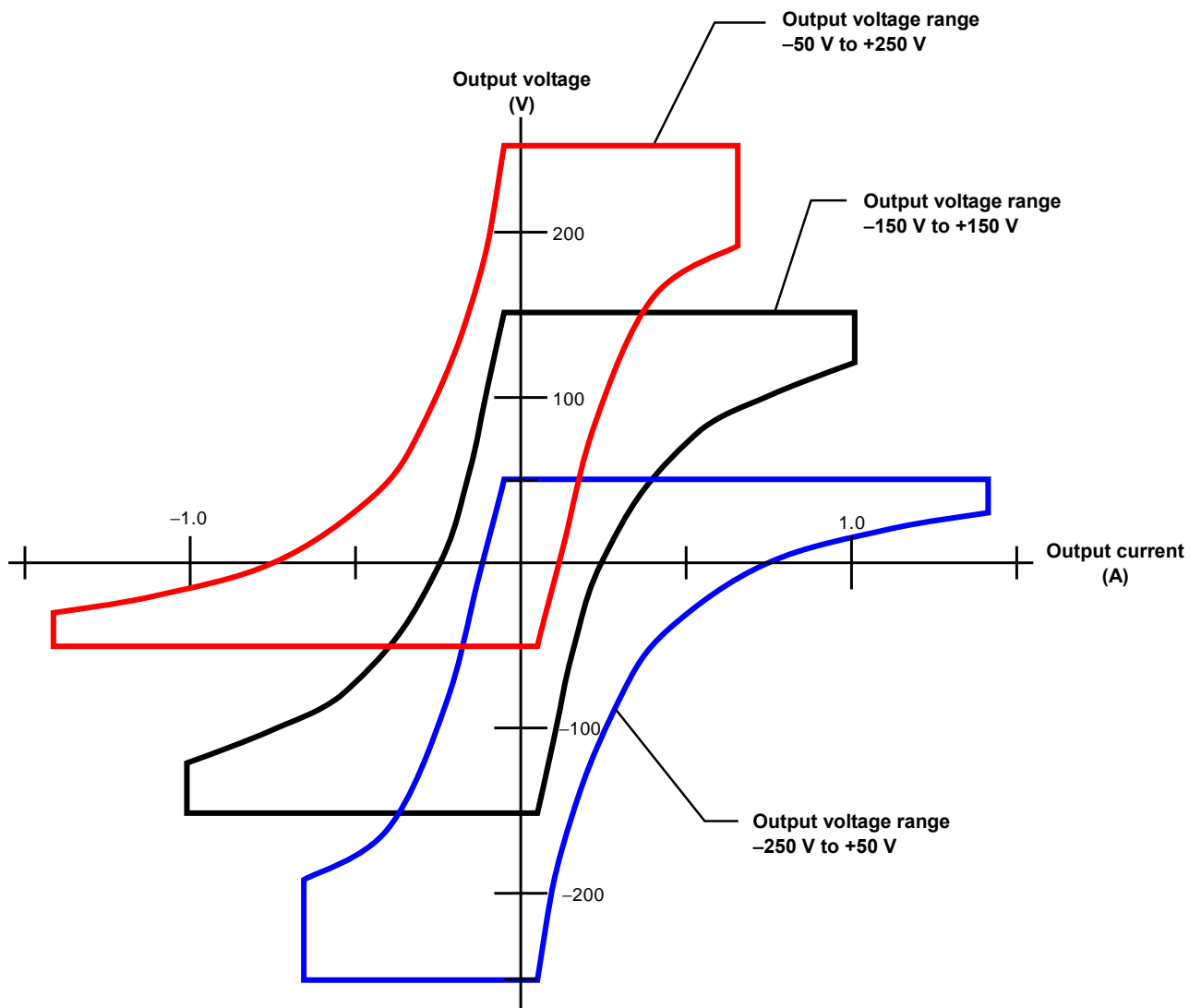

Figure 7-2. Output Voltage/Current Range (DC)

## 7.3 Monitor Output

### ■ Output voltage monitor

Monitor ratio:	1/100 of output voltage (1 V/100 V), in phase as output voltage
Monitor accuracy:	±5.0% (DC to 1 MHz) (Error between the output voltage and conversion voltage obtained from the monitor voltage, monitor output load impedance 1 MΩ)
Output impedance:	50 Ω
Output terminal:	BNC connector (rear panel)

### ■ Output meter

Indicated data:	Output voltage or output current (Switchable using the switch on the front panel)
Detection method:	Average value detection (AC+DC), calibrated with a sine wave
Full scale:	Voltage: 300 V, Current: 1.5 A
Precision:	Within ±10% of the full scale (sine wave) (Voltage: DC to 1 MHz, Current: DC to 100 kHz)

## 7.4 Protection Function

### ■ Output overload

When an excessive output current or an excessive internal power loss is detected, the output current is clipped and the overload LED on the front panel is lit. Output turns off if the overload state lasts for 10 seconds or more. If the overload state lasts for 60 seconds, a transition is made to sleep operation.

### ■ Output overvoltage

Output turns off when an abnormality is detected. If the output overvoltage state lasts for 60 seconds, a transition is made to sleep operation.

### ■ Power supply section abnormality

When an abnormality is detected, every voltage range LED blinks, output turns off, and a transition is made to sleep operation.

### ■ Abnormal internal temperature

When an abnormality is detected, the overload LED on the front panel is turned on. If the abnormal temperature state lasts for 10 seconds, output turns off. If the state lasts for 60 seconds, a transition is made to sleep operation.

\* Sleep operation: All the operations except power-off are disabled.



## 7.5 External Control I/O

### ■ Control input

Input level:	Hi (1): +4.0 V or more Lo (0): +1.0 V or less
Maximum non-destructive input:	+6 V/-5 V
Input mode:	Photocoupler LED input (250 $\Omega$ in series)
Control item:	Output on/off (0: Off, 1: On)

### ■ State output

Output mode:	Open collector output (housing potential)
Usable voltage and current:	15 V or less, 10 mA or less
State item:	Output on/off (on when a connection is made) Overload (overload when a connection is made)

### ■ Enabling external control

The DIP switch on the rear panel is used (0: Disable, 1: Enable).

### ■ Terminal

D-sub 9-pin multiconnector (rear panel, female, M2.6 screw)

## 7.6 Output On/Off Control

Output on/off: Controllable using the switch on the front panel or external control input (When external control is used, the switch on the front panel can be set to OFF only.)

### 7.7 Setting at Power-on

#### ■ Setting method

The DIP switch on the rear panel is used.

#### ■ Setting items (10 items in total)

- Output on/off
- Gain
- External control on/off
- Output polarity
- Input A on/off
- Input B on/off
- Input impedance 50 Ω/10 kΩ
- DC bias on/off
- Meter V/A
- Output voltage range

### 7.8 Power Input

Voltage range:	100 V AC to 230 V AC ±10% (not exceeding 250 V) Overvoltage Category II
Frequency range:	50 Hz/60 Hz ±2 Hz (single phase)
Power consumption:	350 VA or less
Power factor:	0.95 or more

### 7.9 Safety and EMC

(Only Models with a CE Marking on the Rear Panel)

#### ■ Safety

Compliant with the following standard requirement

- EN 61010-1:2010  
Pollution Degree 2

#### ■ EMC

Compliant with the following standard requirement

- EN 61326-1:2006 (Group 1, Class A)
- EN 61000-3-2:2006
- EN 61000-3-3:1995 + A1:2001 + A2:2005

\* The output may become off if the BA4825 is exposed to a strong radiated radio frequency electromagnetic field.

\*This product may cause interference if used in residential areas. Such use must be avoided unless the user takes special measures to reduce electromagnetic emissions to prevent interference to the reception of radio and television broadcasts.

## 7.10 Ambient Temperature Range, Ambient Humidity Range, Etc.

Operating environment: Indoor use

Altitude: 2000 m or lower

Operation guarantee: 0°C to +40°C/5% to 85% RH

The absolute humidity must be within the range 1 to 25 g/m<sup>3</sup>, with no condensation.

Performance guarantee: +5°C to +35°C/5% to 85% RH

The absolute humidity must be within the range 1 to 25 g/m<sup>3</sup>, with no condensation.

Storage condition: -10°C to +50°C/5% to 95% RH

The absolute humidity must be within the range 1 to 29 g/m<sup>3</sup>, with no condensation.

Figure 7-3 shows the ambient temperature and humidity ranges.

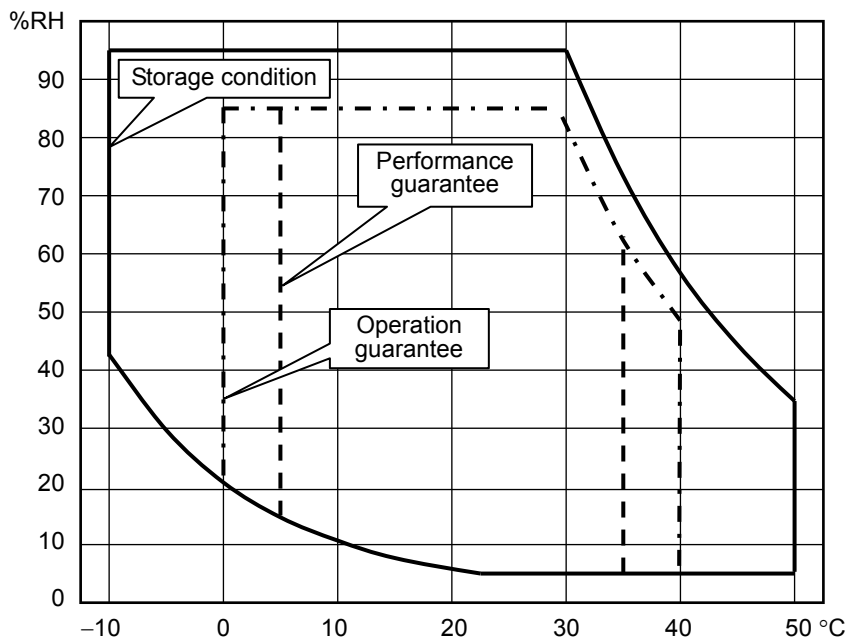

Figure 7-3. Ambient Temperature and Humidity Ranges

## 7.11 External Dimensions and Weight

- External dimensions

Width: 258 mm

Height: 132.5 mm

Depth: 390 mm

(Projections are not included.)

- Weight

About 7 kg

**Figure 7-4** shows the external dimensions.

## 7.11 External Dimensions and Weight

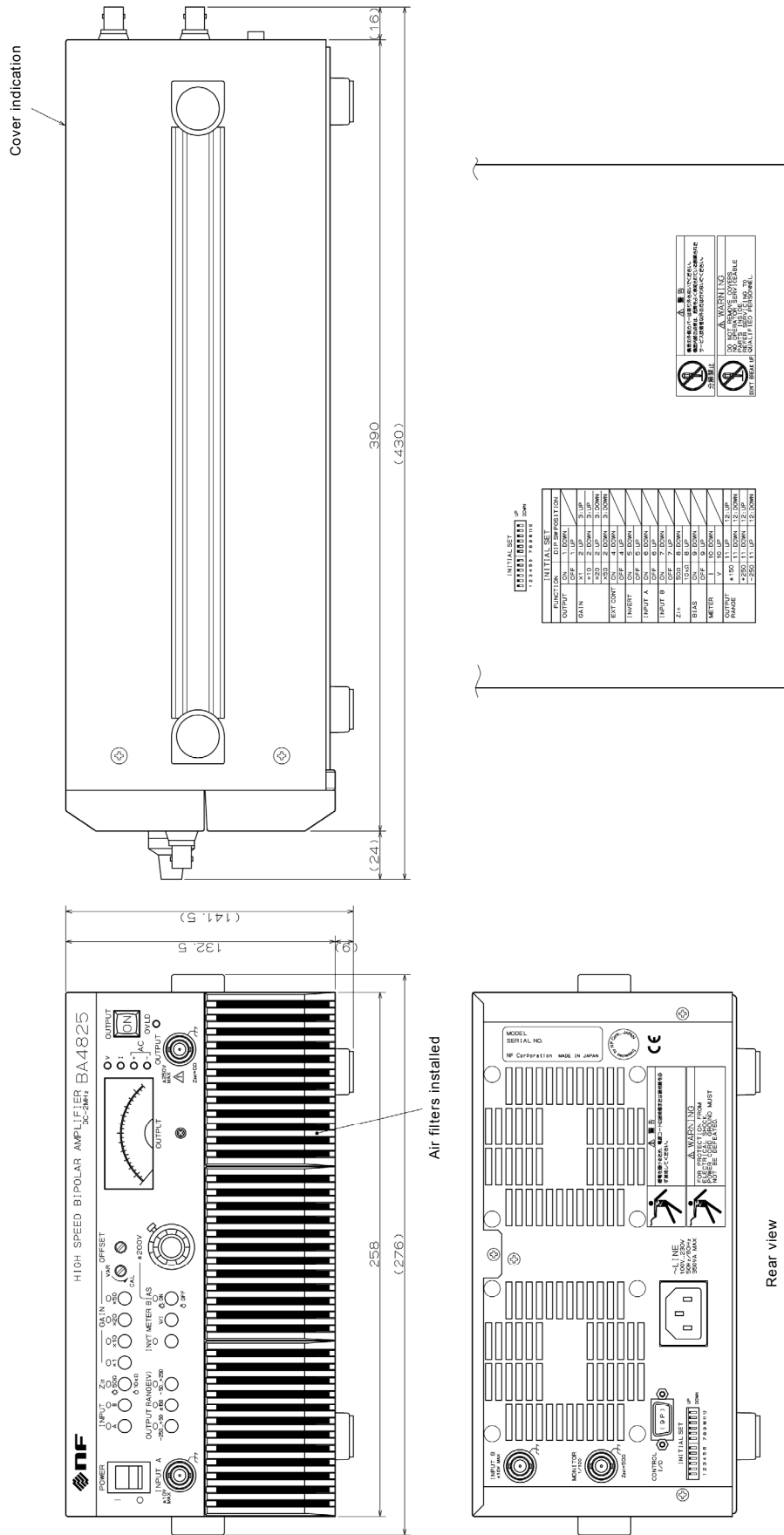

Details of front indication

- Surface treatment
- Front panel: Painting - Ultra light gray (Munsell 6PB9.2/0.1)
  - Rear panel: Silk-screen printing - Munsell 8.5PB2.6/0.2
- Covers:
- Painting - Light gray leather tone (Munsell 6PB7.6/1.2 Leather Tone)

Figure 7-4. External Dimensions

# ————— WARRANTY —————

**NF Corporation** certifies that this product was thoroughly tested and inspected and found to meet its published specifications when it was shipped from our factory.

All **NF** products are warranted against defects in materials and workmanship for a period of one year from the date of shipment. During the warranty period, **NF** will repair the defective product without any charge for the parts and labor. For repair service under warranty, the product must be returned to **NF** representatives. Purchaser shall prepay all shipping charge, duties and taxes for the product to **NF** representatives from another country, and **NF** shall pay shipping charge for the return of the product to purchaser.

This warranty shall not apply to any defect, failure or damage caused by a) improper use; b) improper or inadequate maintenance and care; or c) modification by purchaser or personnel other than **NF** representatives.

**NF Corporation**

WABUN: (DA00015281-004)

If there are any misplaced or missing pages, we will replace the manual. Contact the sales representative.

#### NOTES

- Reproduction of the contents of this manual is forbidden by applicable laws.
- The contents of this manual may be revised without notice.
- Information provided in this manual is intended to be accurate and reliable. However, we assume no responsibility for any damage regarding the contents of this manual.
- We assume no responsibility for influences resulting from the operations in this manual.

Copyright 2006-2014, **NF Corporation**

BA4825 Instruction Manual

### **NF Corporation**

6-3-20, Tsunashima Higashi, Kohoku-ku, Yokohama  
223-8508 JAPAN

Phone +81-45-545-8128 Fax +81-45-545-8187

