



LCR METER

ZM2376

Instruction Manual (Basics)

DA00042208-005

LCR METER

ZM2376

Instruction Manual (Basics)

Registered Trademarks

National Instruments and LabVIEW are registered trademarks of National Instruments Corporation in the United States.

Other company names and product names used in this Instruction Manual may be trademarks or registered trademarks of respective companies.

Preface

Thank you very much for purchasing our “ZM2376 LCR METER”.

Please read, first of all, "Safety Precautions" on the following pages, to use the instrument in the correct and safe manner.

■ Caution Symbols Used in This Manual

The following caution symbols are used in this manual. Be sure to observe these caution symbols and their contents to ensure the safety of the user and avoid damage to the equipment.

 WARNING

Equipment handling could result in death or serious injury. This symbol contains information to avoid such risk.

 CAUTION

Equipment handling could result in minor or moderate injury or property damage. This symbol contains information to avoid such risk.

■ The scope of this Manual

This manual describes the ZM2376 with the firmware version 1.00 or more and CE Marking.

Please make sure the CE marking on the rear panel.

Please watch the version that appears at the power-on.

- The following instruction manuals are provided for ZM2376.
 - ZM2376 Instruction Manual (Basics)

This manual describes basic items such as how to operate ZM2376 from the panel, specifications, and maintenance.
 - ZM2376 Instruction Manual (Remote Control)

This manual describes how to remote control ZM2376.
It includes the description of standard commands (ZM2376 primary commands).
 - ZM2376 Instruction Manual (Alternative Commands)

This manual describes the alternative commands of ZM2376.
If you find the alternative commands easier to use than the standard commands, you can use them. However, the alternative command provides limited functions.

- This manual (Basics) has the following chapters.

If using this equipment for the first time, start from Chapter 1.

1. OUTLINE

This chapter describes the overview, specificities, applications, functions and simple principle of operations of this product.

2. PREPARATIONS BEFORE USE

This chapter describes important preparation before installation and operation.

3. PANEL FEATURES AND BASIC OPERATIONS

This chapter describes the functions and basic operations available for each panel screen part.
Read while operation the instrument.

4. ADVANCED OPERATIONS

This chapter describes even further the instrument operation.

5. TROUBLESHOOTING

This chapter describes how to deal with error messages and troubles.

6. MAINTENANCE

This chapter describes storage, repacking transportation as well as performance testing.

7. SPECIFICATION

This chapter describes the product's specifications (functions and performance).

———— Safety Precautions ————

To ensure safe use, be sure to observe the following warnings and cautions.

NF Corporation shall not be held liable for damages that arise from a failure to observe these warnings and cautions.

This product is a Class I product (with protective conductor terminal) that conforms to the IEC insulation standards.

- Be sure to observe the contents of instruction manual.

This instruction manual contains information for the safe operation and use of this product.

Be sure to read this information first before using this product.

All the warning items contained in this instruction manual are intended for preventing risks that may lead to serious accidents. Ensure to obey them.

- Be sure to ground the product.

This product uses a line filter, which may cause electric shock if the product is not grounded.

To prevent electric shock accidents, connect it to an earth ground so that ground resistance is 100Ω or less.

- Check the power supply voltage.

This product operates on the power supply voltage indicated in “Grounding and Power Supply Connection” in this instruction manual.

Prior to connecting the power supply, check that the voltage of the power outlet matches the rated power supply of the product.

- In case of suspected anomaly

If this product emits smoke, an abnormal smell, or abnormal noise, immediately power it off and stop using it.

If such an abnormal occurs, prevent anyone from using this product until it has been repaired, and immediately report the problem to NF Corporation or one of our representatives.

- Do not use this product when gas is present.

An explosion or other such hazard may result.

- Do not remove the cover.

This product contains high-voltage parts. Absolutely never remove its cover.

Even when the inside of this product needs to be inspected, do not touch the inside. All such inspections are to be performed by service technicians designated by NF Corporation.

- Do not modify this product.
Never modify or try to modify the instrument. Your modification of the instrument could cause unexpected accidents or failures. NF Corporation has the right to refuse providing services for any instruments modified by unauthorized persons.
- Do not expose this product to water.
When this product is used in wet condition, it may cause an electric shock and a fire. If this product is exposed to water, unplug the power cord immediately, and contact NF Corporation or one of our representatives.
- If lightning occurs, power off this product and unplug the power cord.
A lightning may cause an electric shock, a fire and a failure.
- Safety-related symbols
The general definitions of the safety-related symbols used on this product and in the instruction manual are provided below.



Instruction Manual Reference Symbol

This symbol is displayed to alert the user to potential danger and refer him/her to the instruction manual.



Warning Symbol

This symbol indicates information for the avoidance of a hazard such as electric shock that may endanger human life or cause injury during handling of the equipment.



Caution Symbol

This symbol indicates information for the avoidance of damage to the equipment during handling.

● Other Symbols



This symbol indicates the “on” position of the power switch.



This symbol indicates the “off” position of the power switch.



Shows when connected to the housing.

———— Electromagnetic Compatibility ————

This product may cause interference if used in residential areas. Such use must be avoided unless the user takes special measures to reduce electromagnetic emissions to prevent interference to the reception of radio and television broadcasts.

———— Request about disposal ————

To protect the environment, ensure that this device is disposed of by an appropriate industrial waste processor. This product does not use batteries or a backlight that contains mercury.

Table of Contents

	Page
1. OUTLINE.....	1-1
1.1 Features	1-2
1.2 Applications.....	1-3
1.3 List of Functions	1-4
1.4 Principle of Operation	1-5
2. PREPARATIONS BEFORE USE	2-1
2.1 Checking Before Use	2-2
2.2 Installation.....	2-6
2.2.1 General Precautions for Installation	2-6
2.2.2 Installation Conditions	2-6
2.2.3 Rack Mounting.....	2-7
2.3 Grounding and Power Supply Connection	2-12
2.4 Simplified Operation Check	2-13
2.5 Calibration.....	2-14
3. PANEL FEATURES AND BASIC OPERATIONS.....	3-1
3.1 Panel Component Names and Functions.....	3-2
3.2 Display at Power “ON” and Initial Settings	3-4
3.2.1 Check before Power “ON”	3-4
3.2.2 Displays and Indications at Power “ON”.....	3-5
3.2.3 Initialization	3-6
3.3 Operation Tree.....	3-13
3.4 Connection of DUT	3-17
3.4.1 Measurement Terminals	3-17
3.4.2 Connection to DUT	3-18
3.4.3 Precautions on Connection.....	3-19
3.5 Basic Operations	3-21
3.5.1 Outline of Measurement Screen	3-21
3.5.2 Basic Key Operations	3-22
3.5.3 Simplified Operating Method When You Use Instrument for the First Time.....	3-25
3.5.4 Initialization	3-29
3.5.5 Setting of Measurement Parameters.....	3-30
3.5.5.1 Selection of Primary Parameters	3-30
3.5.5.2 Setting of Equivalent Circuit.....	3-32
3.5.5.3 Setting of Secondary Parameters	3-33
3.5.6 Setting of Basic Measurement Conditions	3-35
3.5.6.1 Measurement Frequency	3-35
3.5.6.2 Measurement Signal Level.....	3-36
3.5.6.3 Measurement range.....	3-37
3.5.6.4 Trigger.....	3-43
3.5.6.5 Measurement speed	3-48
3.5.6.6 Correction of Measurement Error.....	3-51
3.5.6.7 OPEN Correction	3-53
3.5.6.8 SHORT Correction	3-59
3.5.6.9 LOAD Correction.....	3-63

Table of Contents

3.5.6.10 Cable Length Correction	3-73
4. ADVANCED OPERATIONS.....	4-1
4.1 Measuring with Specific Voltage or Current (ALC)	4-2
4.2 Restricting the Variation of Measured Value (Averaging)	4-6
4.3 Displaying the Deviation from the Reference Value	4-7
4.4 Sorting the Part (Comparator)	4-10
4.5 Connecting to the Part handler (Handler Interface)	4-20
4.6 Measuring with More Than One Condition (Multi-measurement)	4-30
4.7 Changing the Contents Displayed on the Second Line of Measurement Screen (Auxiliary Display)	4-37
4.8 Saving/Recalling the Setting and Correction Value into the Memory.....	4-39
4.9 Setting the Contact Check.....	4-41
4.10 Applying the DC Bias Voltage	4-44
4.11 Applying the DC Bias Current.....	4-51
4.12 Disabling the Key-Operation of Panel	4-54
4.13 Changing the Settling Wait Time During Automatic Adjustment.....	4-55
4.14 Initializing of All Settings	4-56
4.15 Self-Diagnosis	4-59
4.16 Checking the Version	4-60
4.17 Remote Control.....	4-61
4.18 Switching the Operation Mode (alternative command).....	4-62
5. TROUBLESHOOTING	5-1
5.1 Error Message	5-2
5.1.1 Errors at Power ON.....	5-3
5.1.2 Errors at Panel Operation.....	5-4
5.1.3 Errors During Measurement.....	5-5
5.1.4 Measured Value Display in Case of Error.....	5-6
5.2 When the Device Appears to be a Problem.....	5-8
6. MAINTENANCE	6-1
6.1 Preface.....	6-2
6.2 Daily Maintenance	6-3
6.3 Storage, Repacking, and Transportation	6-3
6.4 Checking Version Number.....	6-3
6.5 Checking Isolation	6-4
6.6 Performance Testing	6-4
6.6.1 Measurement Frequency Accuracy	6-5
6.6.2 Measurement Signal Level Accuracy	6-5
6.6.3 Voltage Monitor Accuracy.....	6-6
6.6.4 DC Bias Voltage Accuracy.....	6-7
6.6.5 AC Impedance Measurement Accuracy.....	6-8
6.6.6 DC Resistance Measurement Accuracy.....	6-13
6.7 Calibration.....	6-15

Table of Contents

7. SPECIFICATION.....7-1
7.1 Specification.....7-2
7.2 External Dimensions 7-17

Attached figures and tables

		Page
Figure 1-1	Block Diagram.....	1-5
Figure 2-1	Rack-mount assembly (mm-rack).....	2-8
Figure 2-2	Rack-mount assembly (inch-rack).....	2-9
Figure 2-3	Size and dimensions of the rack-mount (mm-rack).....	2-10
Figure 2-4	Size and dimensions of the rack-mount (inch-rack).....	2-11
Figure 3-1	Front panel.....	3-2
Figure 3-2	Rear panel.....	3-3
Figure 3-3	Functions of measurement terminals.....	3-17
Figure 3-4	Connection to DUT.....	3-18
Figure 3-5	Capacitance to measurement signal level characteristics.....	3-39
Figure 3-6	Measurement sequence.....	3-43
Figure 3-7	Signal acquisition time.....	3-49
Figure 3-8	Terminal processing at OPEN correction.....	3-54
Figure 3-9	Terminal processing at SHORT correction.....	3-60
Figure 3-10	Connection circuit network for LOAD correction.....	3-63
Figure 3-11	Measurement of LOAD standard value.....	3-70
Figure 3-12	Measurement of LOAD correction value.....	3-71
Figure 4-1	Maximum capacitance measurable at constant voltage (typical value).....	4-5
Figure 4-2	Inductance range measurable at constant voltage (typical value).....	4-5
Figure 4-3	Output of comparator result.....	4-11
Figure 4-4	Range setting and comparison when sorting into bins.....	4-16
Figure 4-5	Equivalent circuit of handler interface.....	4-23
Figure 4-6	Handler interface operation timing.....	4-24
Figure 4-7	Dummy output timing.....	4-29
Figure 4-8	Handler interface operation timing in the multi-measurement.....	4-35
Figure 4-9	Example of external voltage bias circuit.....	4-49
Figure 4-10	Example of external current bias circuit.....	4-51
Figure 7-1	Range of error.....	7-11
Figure 7-2	LC - Z conversion graph.....	7-12
Figure 7-3	ZM2376 external dimensions.....	7-17

Table of Contents

Table 2-1	Package contents	2-2
Table 3-1	Setting items and initial values.....	3-7
Table 3-2	Measurement range list.....	3-37
Table 3-3	Max. current, max. voltage, and output impedance in each measurement range.....	3-39
Table 3-4	Example of measurement time (typical value).....	3-48
Table 4-1	Display format of measured value and interpretation of setting value (example of L).....	4-14
Table 4-2	Initialization contents of comparator.....	4-14
Table 4-3	Handler interface signal layout.....	4-20
Table 4-4	Functions of handler interface signal.....	4-21
Table 4-5	Handler interface output in the multi-measurement	4-34
Table 5-1	When the device appears to be a problem	5-11

1. OUTLINE

1.1 Features.....	1-2
1.2 Applications.....	1-4
1.3 List of Functions.....	1-5
1.4 Principle of Operation.....	1-6

1.1 Features

The “ZM2376 LCR Meter” is a high speed LCR meter with the maximum frequency 5.5MHz and maximum signal level 5V. It has high basic accuracy of 0.08% and is capable of measuring the impedance in a wide application range from manufacturing and inspection lines of electronic parts up to the research of materials.

- **Measurement frequency 1mHz to 5.5MHz**

The instrument has the maximum 6-digit resolution and thus it is capable of measuring the detailed frequency characteristics of the DUT (Device Under Test).

- **Signal level 10mV to 5V / Maximum current 200mA**

It is capable of measuring the characteristics of DUT in a wide signal level range.

- **Constant voltage / Constant current drive**

It can make evaluation on stable signal level even for the DUT of which characteristics vary with the signal level.

- **High speed measurement**

It provides high speed measurement at the fastest 2ms (1kHz - 1MHz) or 10ms (120Hz).

- **Cable length 0m / 1m / 2m / 4m**

Allowable length of connection cable to the DUT is maximum 4m. However, it is limited by the frequency.

- **Triggered drive**

A signal is output after the instrument contacted the DUT, thus reducing the contact damage when high capacitance capacitor is measured. Also, this feature reduces measurement dispersion of the DUT having hysteresis characteristics.

- **Contact check**

A contact failure to DUT can be detected based on an abnormally low capacitance or abnormal voltage/current signal, with little additional time required.

- **Handler interface**

The bin sorting results of maximum 14 categories can be output to the part handler.

- **Remote control**

The instrument is equipped with the USB, RS-232 (230.4kbps max), and GPIB interfaces as standard, which is useful for installing it in production lines or measurement systems. A LAN interface is also available optionally.

- DC (Direct-current) resistance measurement

Direct-current resistance such as a winding resistance of inductor or transformer can be measured.

- Setting/correction value memory

32 sets of settings and correction values can be stored in nonvolatile memory, and they can be used selectively.

1.2 Applications

- Inspection, sorting, and evaluation test in production lines of electronic parts such as inductors, capacitors, and sensors.
- Evaluation and research of magnetic materials and dielectrics.
- Impedance measurement of batteries.

1.3 List of Functions

The following shows the functional tree of ZM2376.

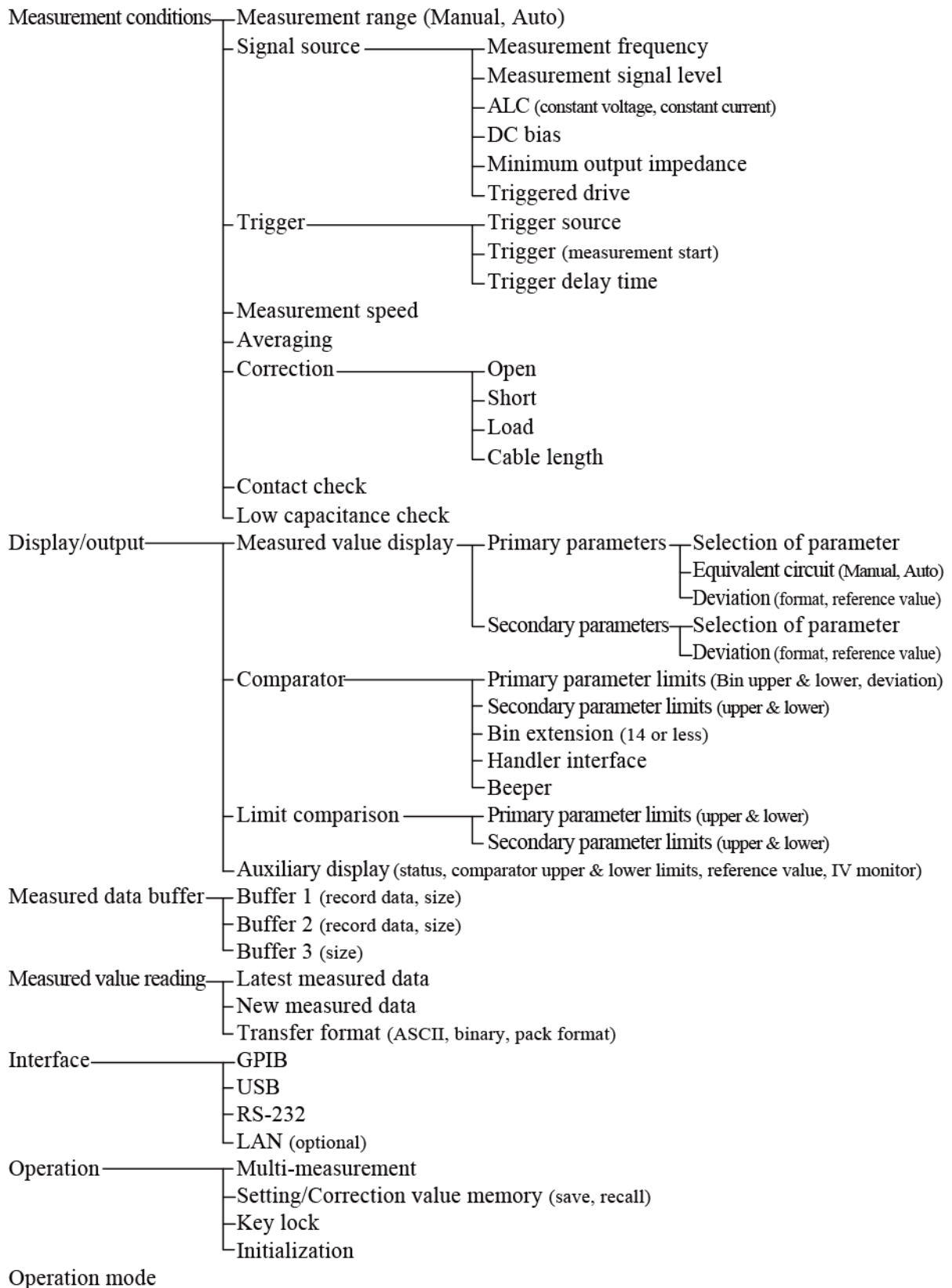

1.4 Principle of Operation

The ZM2376 gives sine wave signal from an internal oscillator to the DUT (Device Under Test). The impedance bridge detects the current I flowing in DUT and the voltage V applied to DUT, and then the main processor obtains the impedance $Z (= V / I)$. The parameters such as inductance L , capacitance C , resistance R , etc. are calculated from the impedance (magnitude, phase angle).

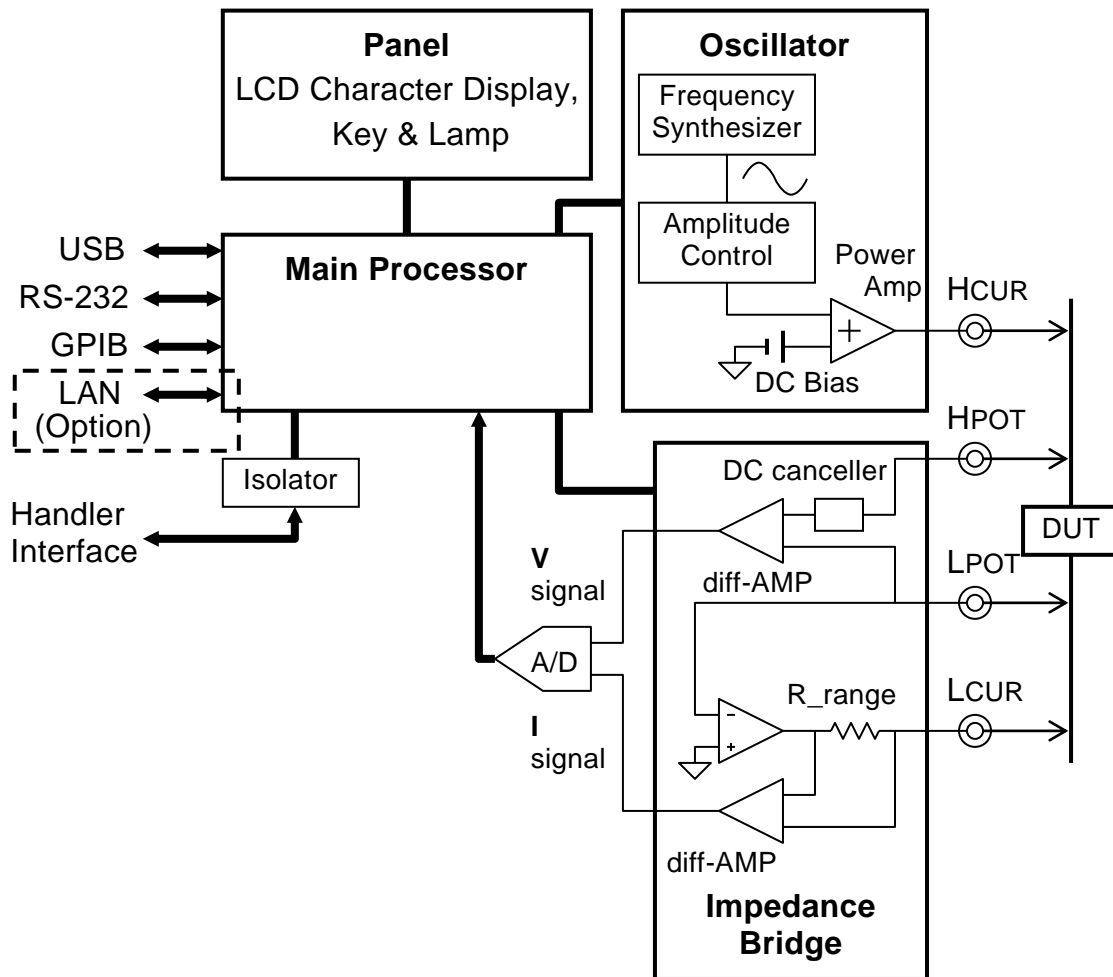

Figure 1-1 Block Diagram

- Main Processor

According to the user's operation, the main processor controls the oscillator and impedance bridge to calculate the vector ratio from the voltage signal and current signal obtained from the DUT. Then, the main processor makes necessary correction, and finally converts the data into the required parameter to be displayed or output.

- **Oscillator**

The oscillator generates sine wave signals having exact frequencies by means of a direct digital frequency synthetic method based on the reference clock of crystal oscillator.

When the Automatic Level Control (ALC) function is effective, the main processor adjusts automatically the signal level so that the voltage and current monitored values become the specified values.

- **Impedance Bridge**

The current flowing in the DUT is converted into the voltage by the range resistance and differential amplifier. At this time, the potential of L_{CUR} between L_{POT} terminals is maintained to almost zero by automatic balancing motion of the bridge. Accordingly, the current that runs away to the ground through capacitance to earth and insulation resistance and is not detected can be reduced.

The voltage applied to the DUT is detected by the differential amplifier.

After that, the voltage signal and current signal are converted into digital values by the A/D converter, and sent to the main processor.

2. PREPARATIONS BEFORE USE

2.1 Checking Before Use	2-2
2.2 Installation	2-6
2.2.1 General Precautions for Installation	2-6
2.2.2 Installation Conditions	2-6
2.2.3 Rack Mounting	2-7
2.3 Grounding and Power Supply Connection	2-12
2.4 Simplified Operation Check	2-13
2.5 Calibration	2-14

2.1 Checking Before Use

■ Safety check

To ensure the safety, refer to “Safety Precautions” described in the beginning of this instruction manual before using ZM2376.

Before turning the power on, read “2.3 Grounding and Power Supply Connection” and observe the necessary cautions.

■ Unpacking

Check that the instrument has not been damaged during transit.

After unpacking, refer to “Table 2-1 Package contents” to check the contents.

Table 2-1 Package contents

ZM2376 Main Unit	1
Instruction Manual (Basics)	1
CD-ROM (see the next page for the contents)	1
Power Cord Set (3 Pole, 2 m)	1

WARNING

This instrument contains high-voltage parts. Never remove the cover.

The internal parts of this instrument must only be serviced by an engineer who has a thorough understanding of risk prevention.

■ Contents of CD-ROM supplied

•ZM2376 Instruction Manual (Remote Control)

This manual describes how to remote control ZM2376.

It includes the description of standard commands.

•ZM2376 Instruction Manual (Alternative Commands)

This manual describes the alternative commands of ZM2376.

•Application Software

Main settings of ZM2376, acquisition and display of measured data, measurement and setting by sweeping the frequencies, and saving of measured data can be performed.

•IVI (Interchangeable Virtual Instrument) Driver

This driver handles the ZM2376 main commands and query. It can be used by various programming languages. LabVIEW can use the IVI driver by importing and converting it to vi or llb.

•Sample Programs

Examples of controlling ZM2376 through various interfaces in various programming languages such as C# and VB.NET are provided.

This section describes the outline. For detailed contents and handling method, refer to the instructions stored in the CD-ROM.

■ Signal cables

Since the signal cables are not supplied, please purchase commercially available cables. The cable specifications are as follows.

•DUT connecting cable

Coaxial cable having BNC connector

To correct the cable length exactly, use a coaxial cable (capacitance about 105pF/m) of characteristic impedance 50Ω.

•GPIB cable

Cable that conforms to the IEEE488.1 Standard.

•USB cable

Cable that conforms to the USB1.1 or USB2.0 Standard.

•RS-232 cable

Interlink cable with D-Sub 9 pins, female-female, inch screws, and shield.

The controllers other than general personal computers have different connector or signal layout and may require a dedicated cable.

•LAN cable

CAT5 or higher (CAT3 or higher for 10BASE-T). Use a straight cable when connecting to a hub or router which does not have the automatic cable recognition function, or use a cross cable when connecting to a peer PC.

■ Major relevant products

Since the test fixture and test lead are not supplied, please purchase them additionally. Major test fixtures and test leads which can be used with ZM2376 are shown below.

Model name	Product name	Supplemental note	Frequency range
ZM2363	Test fixture	For lead components 4-terminal connection	DC - 10MHz
2324	4-terminal alligator clip test leads	-----	DC - 100kHz
2325AL	Kelvin clip test leads	Large-sized clip (replaceable clip)	DC - 100kHz
2325AM	Kelvin clip test leads	Medium-sized clip (replaceable clip)	DC - 100kHz
ZM2392	Kelvin clip test leads	Simple type	DC - 20kHz
ZM2391	3-terminal alligator clip test leads	Two signals, one shield	DC - 20kHz
2326A	Chip component test lead	Tweezers type 2-terminal connection	DC - 1.2MHz
ZM2394	Chip test fixture	For SMD & chip parts 2-terminal connection	DC - 2MHz
ZM2394H	Chip test fixture	For SMD & chip parts 2-terminal connection	DC - 30MHz

The models connected to the DUT with two terminals are affected by the contact resistance and its variations. For a measurement of about 50Ω or less, it is recommended to evaluate the variation of measured value due to the contact resistance before using the test fixture.

The information given here is as of the preparation of this Instruction Manual. Relevant products are subject to change, abolition, or addition without notice. Be sure to contact NF Corporation or one of our representatives for confirmation when ordering them.

2.2 Installation

2.2.1 General Precautions for Installation

CAUTION

Take the following precautions to prevent damage to ZM2376.

- ZM2376 is cooled by forced air-cooling.
Do not block the air inlet on both side panels and the air outlet on the rear panel.
 - ZM2376 must be installed horizontally (with the bottom panel facing the floor).
Using the instrument with the rear panel or side panel facing downward (in the upright position) causes the instrument to be toppled down easily, leading to a danger.
-

■ Handling of the panel and housing

The front panel of ZM2376 is made of plastic. It can be damaged by sharp or hot tools.

When the housing/panel surface needs cleaning, wipe with a soft cloth. To remove persistent contamination, wipe with a soft cloth soaked with neutral detergent and wrung out. Do not use any organic solvents like thinner or benzene, or any chemical cleaning cloth, as they may cause the surface finish to deteriorate, tarnish, or come off.

2.2.2 Installation Conditions

Install ZM2376 in a place that satisfies the following temperature and humidity conditions.

Operation 0 to +40°C, 5 to 85% RH (where absolute humidity is 1 to 25g/m³, non-condensing)

Altitude:2000m or less

Storage -10 to +50°C, 5 to 95% RH (where absolute humidity is 1 to 29g/m³, non-condensing)

CAUTION

Do not install the instrument in locations such as:

- Place exposed to direct sunlight, or place near a heat source.
 - Environment with dust, salinity, or metallic powder.
 - Environment with corrosive gas, moisture, or oil smoke.
 - Place of frequent vibration.
 - Place near an intense magnetic or electric field source.
 - Place near a pulse noise source.
-

If the measurement accuracy is important, warm up the instrument for more than 30 minutes before use. Ensure adequate distance between power cable of ZM2376 or other devices and signal cable. Close distance between power cable and signal cable may cause measurement dispersions due to a malfunction or noise.

⚠ CAUTION

This product may cause interference if used in residential areas. Such use must be avoided unless the user takes special measures to reduce electromagnetic emissions to prevent interference to the reception of radio and television broadcasts.

2.2.3 Rack Mounting

ZM2376 can be mounted on a 19-inch IEC rack, an EIA specification rack or a JIS specification rack by the use of a rack-mount adapter (optional). The rack-mount adapter is provided for mm-rack and inch-rack.

First, mount the rack-mount adapter on the device as shown in “Figure 2-1 Rack-mount assembly (mm-rack)” or “Figure 2-2 Rack-mount assembly (inch-rack)”, and then, mount the instrument on the rack.

⚠ WARNING

When mounting the instrument on the rack, be sure to install rack rails to support the ZM2376. Otherwise, ZM2376 may fall, causing a human injury.

⚠ CAUTION

- When mounting the instrument on the rack, be sure to install rack rails to support the ZM2376. Otherwise, ZM2376 may fall, causing a product damage.
- Make sure that the rack is sufficiently air-cooled by providing appropriate ventilation ports or cooling fans.
- The air inlet of ZM2376 is provided on both side panels.
Ensure 20mm or more clearance between side panel and wall.
- The air outlet is provided on the rear panel.
Ensure 50mm or more clearance between rear panel and wall.

Higher ambient temperature than the specification or blocking the air inlet or outlet may reduce the performance or damage the ZM2376.

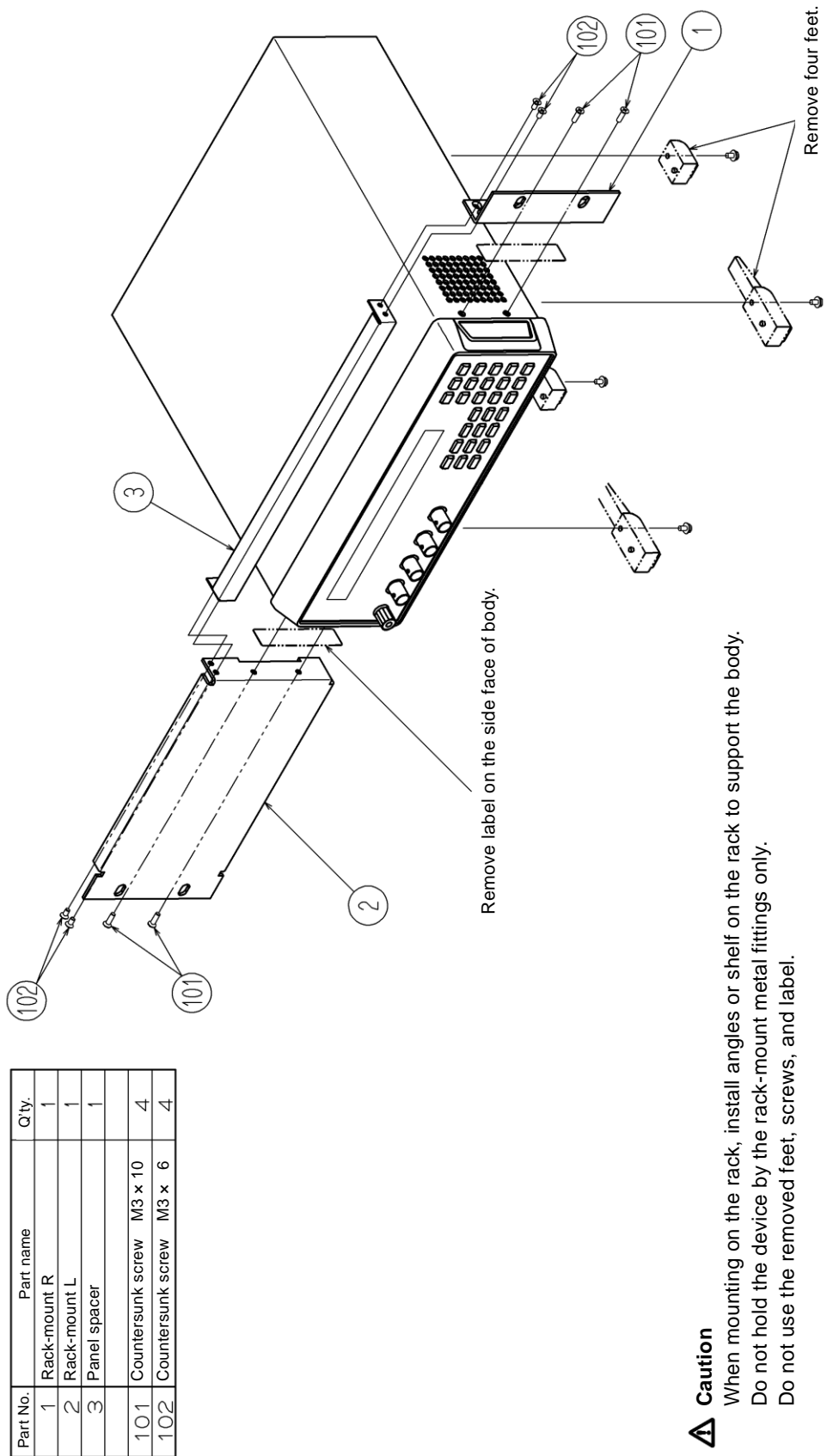

Figure 2-1 Rack-mount assembly (mm-rack)

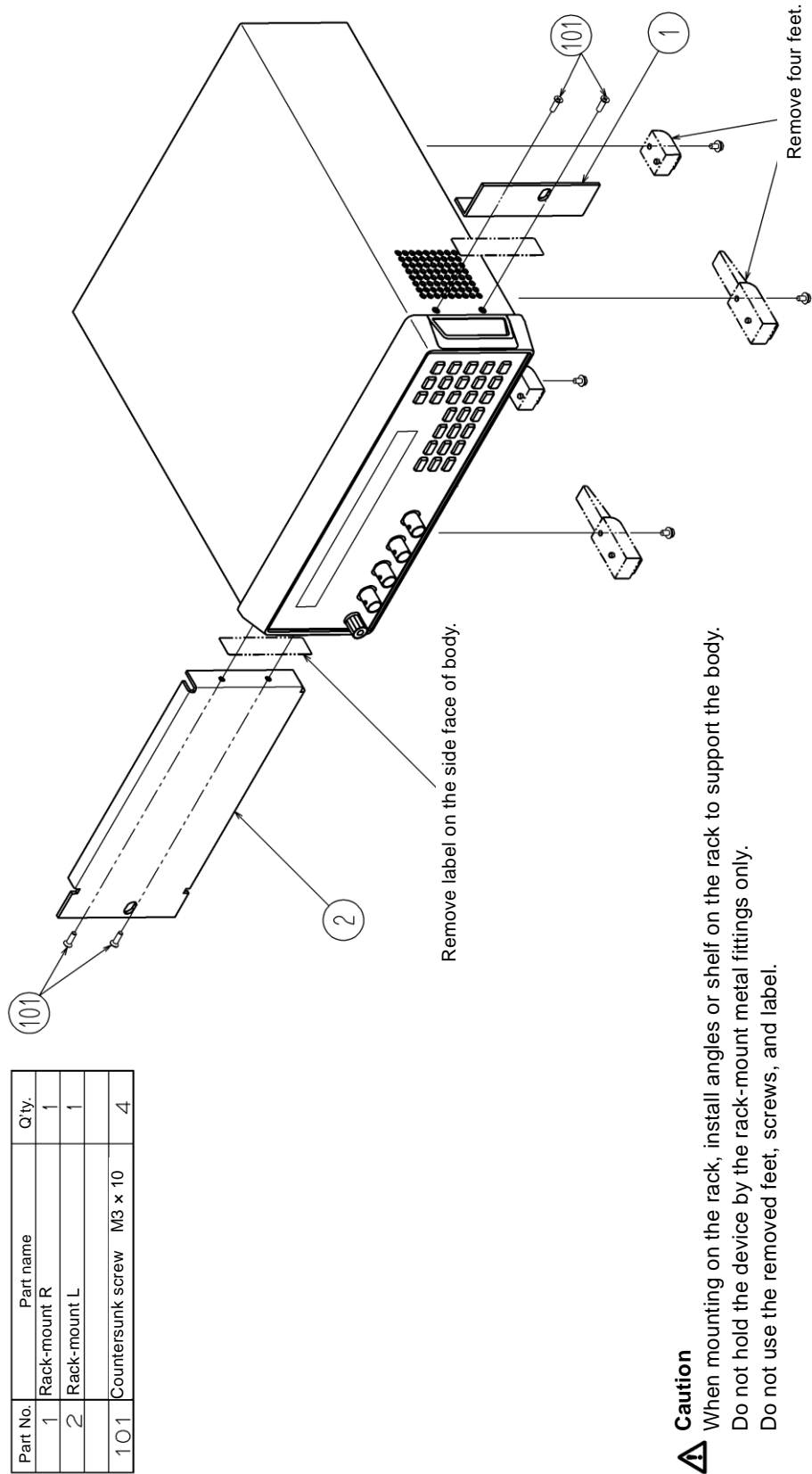
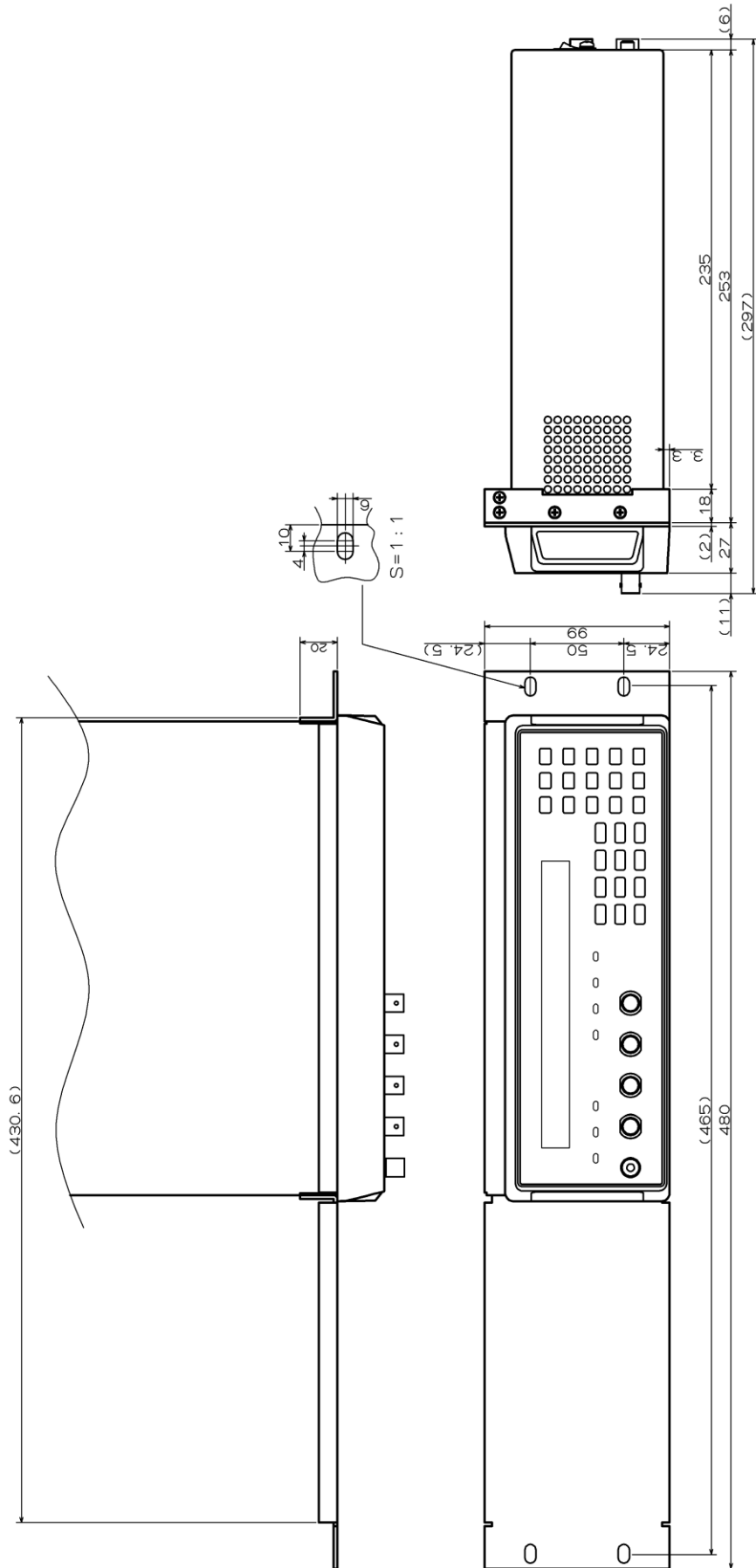

Figure 2-2 Rack-mount assembly (inch-rack)



Surface treatment
 Rack-mount adapter: Paint Ultra light gray (Munsell 6. OPB9. 2/0. 1)
 Caution
 When mounting on the rack, do not hold only the rack-mount adapter.
 Make sure that the rack uses L metal fittings or shelves to hold the body.

Figure 2-3 Size and dimensions of the rack-mount (mm-rack)

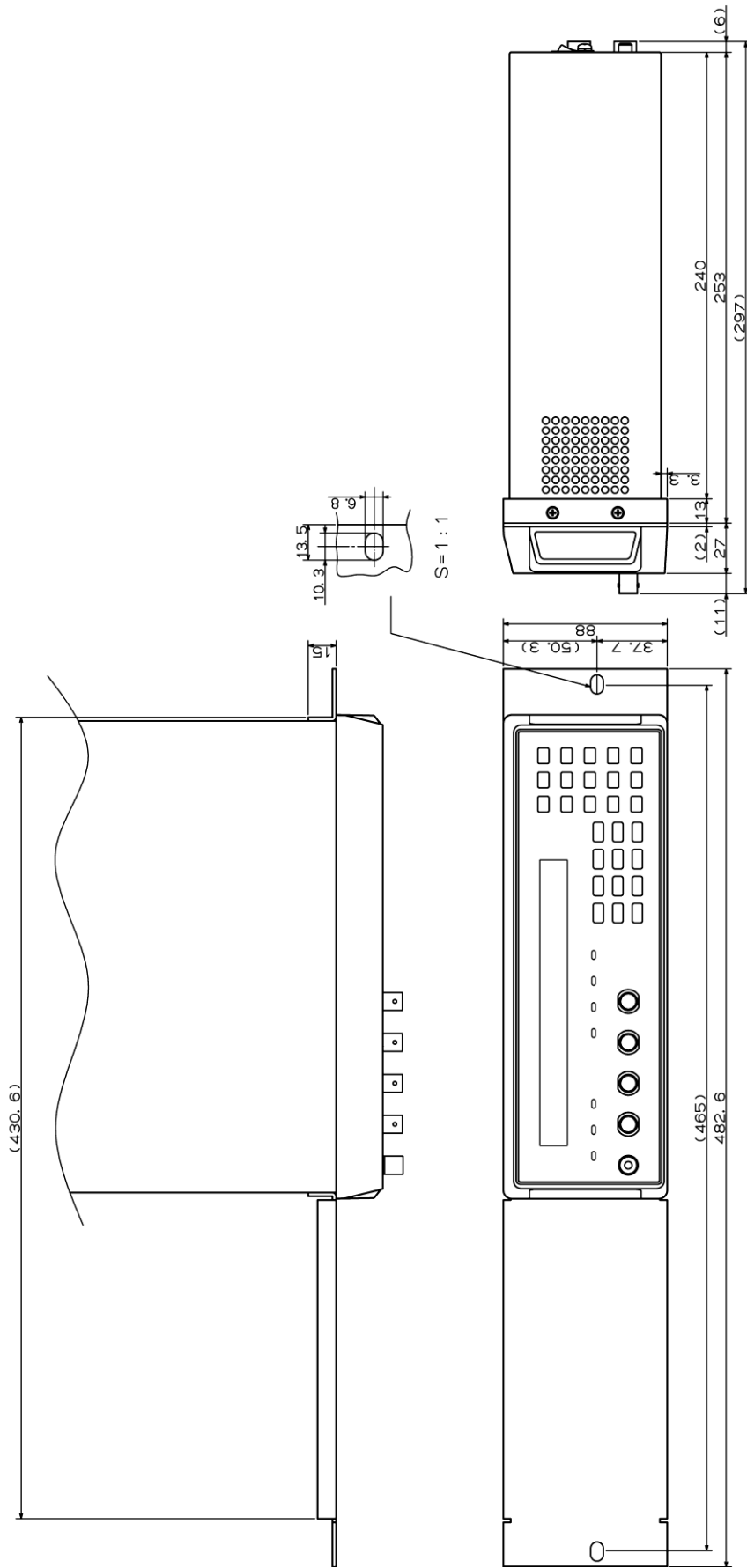

Figure 2-4 Size and dimensions of the rack-mount (inch-rack)

Surface treatment
 Rack-mount adapter: Paint Ultra light gray (Munsell 6. OPB9. 2/0. 1)
 Caution
 When mounting on the rack, do not hold only the rack-mount adapter.
 Make sure that the rack uses L metal fittings or shelves to hold the body.

2.3 Grounding and Power Supply Connection

■ Grounding

WARNING

Take the following precautions to avoid risk of electric shock.

Before connecting the instrument for measurement, make sure the protective grounding terminal is grounded.

The protective grounding terminal for ZM2376 is the grounding pin of the three-pole power cord. Make sure you insert the power cord's plug into a three-pole power outlet with a protective grounding contact.

■ Power Supply

CAUTION

Before connecting the power supply, make sure that the voltage of power outlet is within the power voltage range of the specifications. Otherwise, ZM2376 may be damaged.

ZM2376 operates the following commercial power supplies.

Power voltage range: 100 to 230VAC $\pm 10\%$, but 250VAC or less.

Power frequency range: 50Hz/60Hz $\pm 2\text{Hz}$

Maximum power consumption is 75VA or less.

The power switch of ZM2376 is located on the rear panel.

Make sure that the power switch is set to OFF before connecting the power cord.

After powering off the instrument, be sure to wait for at least five seconds before powering on again.

WARNING

This instrument contains high-voltage parts. Never remove the cover.

CAUTION

The power cord which comes with the instrument is exclusively used with the instrument only. Do not use this power cord for other equipment or purposes.

2.4 Simplified Operation Check

Before an important measurement or after a long unused time of instrument, it is recommended to check the ZM2376 operation by the following procedure. Check it within an application range.

1. Plug the power cord in the AC outlet and turn on the power switch on the rear panel.
Wait until the starting message disappears and the measurement screen is displayed.
2. Initialize the settings.
Press the **SHIFT** + **[INIT]** keys to display the initialize menu, and press the **1** key.
(First press the **SHIFT** key, and then press the **0** | **[INIT]** key where INIT is written in upper place.)
3. Connect the test fixture or test leads to the measurement terminal on the front panel.
4. Attach the DUT to the test fixture or test leads.
Prepare the DUT of which value is known exactly every measurement range used. For 1k Ω range, for instance, a value of about 1k Ω will be appropriate.
5. Switch the measurement conditions, and check that the measurement can be performed normally.
FREQ key : Display the measurement frequency setting menu and set the frequency.
LEVEL key : Display the measurement signal level setting menu and set the voltage.

-- Evaluation of measured result --

The measured value may vary depending on the connection method or whether OPEN and SHORT are corrected or not, and accordingly an error due to these factors should be taken into consideration. Also, as the impedance of DUT itself may vary depending on the frequency or signal level, the DUT's characteristics should be checked in advance.

6. Check the triggered drive timing (if used).
Press the **SHIFT** + **[TRIG MODE]** keys to display the trigger setting menu, and press the **1** key to set the trigger source to Manual.
Press the **SHIFT** + **[TRIG MODE]** keys to display the trigger setting menu, and press the **5** key to select S.Sync. Further, press the **1** key to select ON, so as to make the triggered drive valid, and then press the **[EXIT]** key to return to the measurement screen (**[EXIT]** key: **ENTR** | **[EXIT]** key where EXIT is written in lower place).
Attach the DUT to the test fixture, and observe the signal of the H terminal with an oscilloscope.
Press the **TRIG** key to check that the drive signal is output only at the measurement.

Thus, the simplified operation check is completed.

Finally, it is recommended to initialize the settings.

2.5 Calibration

Ensure that ZM2376 undergoes the test described in “6.6 Performance Testing” at least once a year, depending on the use environment and use frequency.

It is recommended to conduct a performance test before using it for an important measurement or test.

If the performance test does not produce satisfying results, NF Corporation will make the necessary adjustment or calibration to restore performance.

When the calibration or adjustment is necessary, please contact NF Corporation or one of our representatives.

You will be liable for the costs of calibration or adjustment.

3. PANEL FEATURES AND BASIC OPERATIONS

- 3.1 Panel Component Names and Functions.....3-2
- 3.2 Display at Power “ON” and Initial Settings.....3-4
 - 3.2.1 Check before Power “ON”3-4
 - 3.2.2 Displays and Indications at Power “ON”3-5
 - 3.2.3 Initialization3-6
- 3.3 Operation Tree3-11
- 3.4 Connection of DUT3-15
 - 3.4.1 Measurement Terminals.....3-15
 - 3.4.2 Connection to DUT.....3-16
 - 3.4.3 Precautions on Connection3-17
- 3.5 Basic Operations3-19
 - 3.5.1 Outline of Measurement Screen.....3-19
 - 3.5.2 Basic Key Operations.....3-20
 - 3.5.3 Simplified Operating Method When You Use Instrument for the First Time3-23
 - 3.5.4 Initialization3-27
 - 3.5.5 Setting of Measurement Parameters3-28
 - 3.5.5.1 Selection of Primary Parameters3-28
 - 3.5.5.2 Setting of Equivalent Circuit3-30
 - 3.5.5.3 Setting of Secondary Parameters3-31
 - 3.5.6 Setting of Basic Measurement Conditions3-33
 - 3.5.6.1 Measurement Frequency.....3-33
 - 3.5.6.2 Measurement Signal Level3-34
 - 3.5.6.3 Measurement range3-35
 - 3.5.6.4 Trigger.....3-41
 - 3.5.6.5 Measurement speed3-46
 - 3.5.6.6 Correction of Measurement Error3-49
 - 3.5.6.7 OPEN Correction.....3-52
 - 3.5.6.8 SHORT Correction3-58
 - 3.5.6.9 LOAD Correction3-62
 - 3.5.6.10 Cable Length Correction.....3-74

3.1 Panel Component Names and Functions

This section describes the names and functions of the components on the front and rear panel of ZM2376.

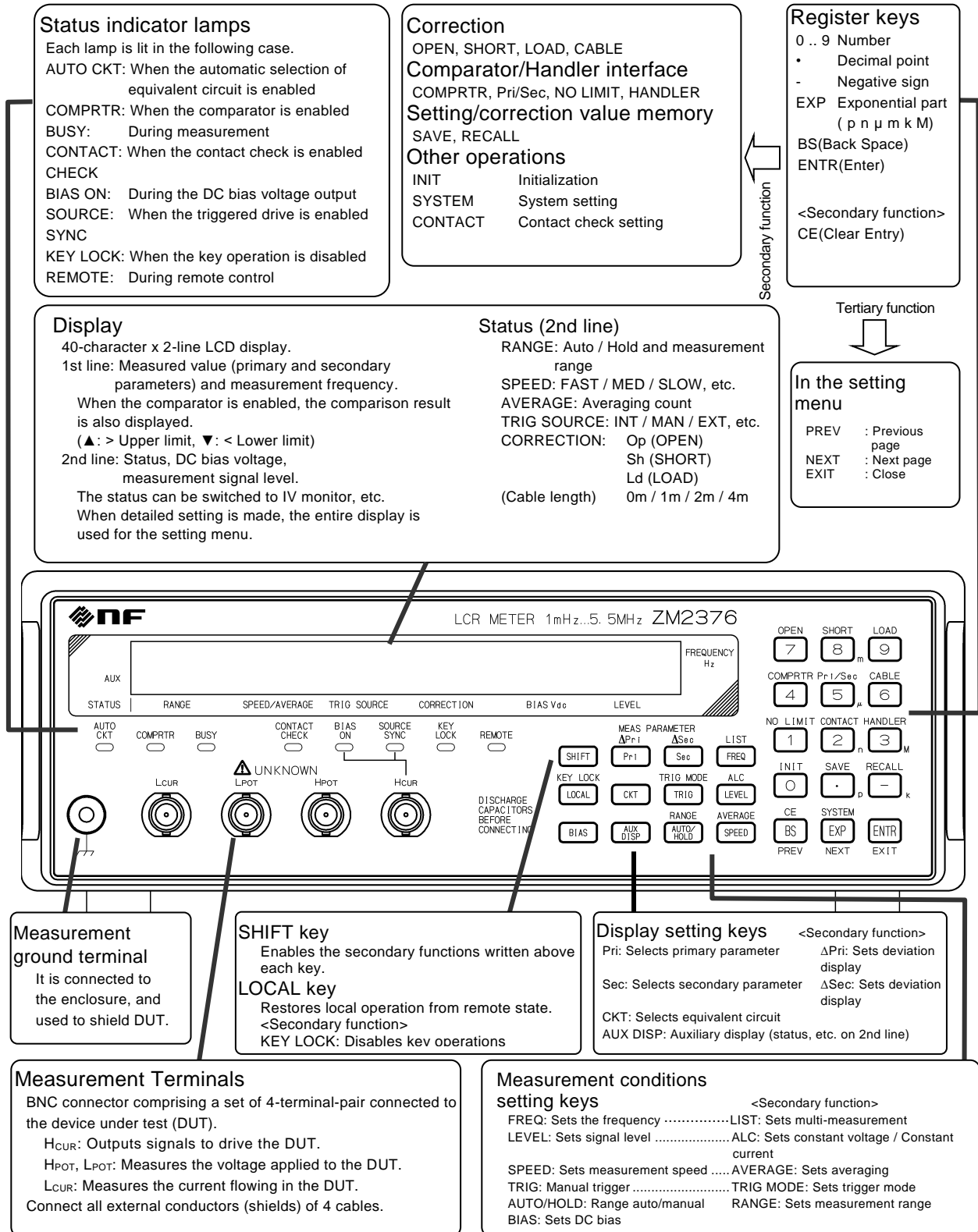

Figure 3-1 Front panel

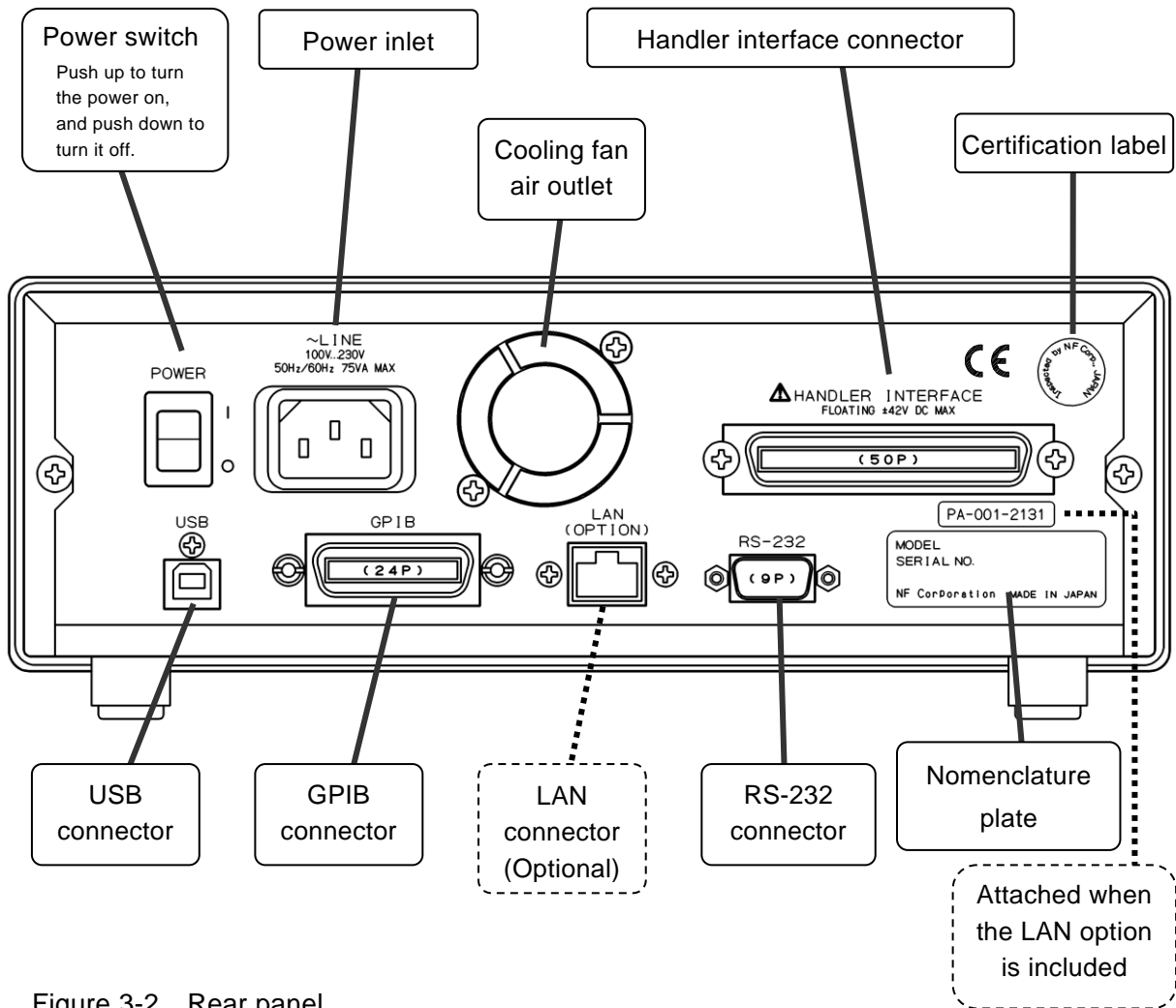

Figure 3-2 Rear panel

3.2 Display at Power “ON” and Initial Settings

3.2.1 Check before Power “ON”

ZM2376 operates the following commercial power supplies.

Power voltage range: 100 to 230VAC $\pm 10\%$, but 250VAC or less.

Power frequency range: 50Hz/60Hz $\pm 2\text{Hz}$

The power consumption is 75VA or less.

WARNING

Take the following precautions to avoid accidents due to electric shock.

Before connecting the instrument for measurement, make sure the protective grounding terminal is grounded.

The protective grounding terminal for ZM2376 is the grounding pin of the three-pole power cord.

Make sure you insert the power cord’s plug into a three-pole power outlet with a protective grounding contact.

CAUTION

Be sure to connect to the power outlet after checking that the power voltage is within the specified range for the ZM2376. Otherwise, ZM2376 may be damaged.

Make sure that the power switch is set to OFF before connecting the power cord.

After turning the power off, be sure to wait for at least 5 seconds before turning it on.

CAUTION

Wait at least 5 seconds between each power activation/deactivation.

Turning the power on and off in a very short span of time may cause the device to not work properly.

Turn the power on according to the following procedure.

- Make sure that the power switch is OFF (turned downward).
- Connect the power cord to the power inlet at the back of the device.
- Insert the power cord’s plug to a three-pole power outlet.
- By switching the power switch upward the ZM2376 is turned on.

When the power switch is turned on, a starting message is displayed and then the device becomes ready for measurement.

Display at launch  “3.2.2 Displays and Indications at Power “ON” ”

3.2.2 Displays and Indications at Power “ON”

Take necessary steps before instrument usage/operation according to “2. PREPARATIONS BEFORE USE”.

When the power switch is turned on, a test pattern is displayed, and then a starting message including the model name and firmware version is displayed (see below).

Model name

Example:

ZM2376
V1.00 2013/10/25 16:27

Version Last adjustment date and time

Also, all lamps light up. During this time, the self diagnosis is conducted. If an error is found, an error message is displayed.

For details ➤ “5.1.1 Errors at Power ON”

If a serious error is found, the device will no longer operate with an error message displayed.

When a setting or correction value has been lost, an error message is displayed but the parameter for which the error occurred is initialized and started. This error message can be reset by pressing any key.

Initialization contents ➤ “3.2.3 Initialization”

The settings and correction values at the time when the power was turned off last are resumed unless the resume memory that saves last settings is normal.

3.2.3 Initialization

ZM2376 is reset to the factory default settings in the following cases:

- At the time of shipment from factory
All settings and correction values including operation modes and memory contents are set to the initial values.
- When full initialization of settings is specified
Except operation modes, the memory contents, settings, and correction values are reset to the factory default settings.
☞ “4.14 Initializing of All Settings”
- At the power ON, if backed up setting or correction value is faulty
Faulty part is initialized.
☞ “3.2.2 Displays and Indications at Power “ON” ”
- When operation mode is switched
The settings and correction values except operation modes are all initialized including memory contents.
For details of the initial setting in the operation mode 1, see “Instruction Manual (Alternative Commands)”.

To start the operation from the initial setting state, perform initialization as follows:

- After pressing the **SHIFT** key, press the **0** | **[INIT]** key to display the initialize menu, and press the **1** key.
Initialized items, initialized contents ☞ “Table 3-1 Setting items and initial values”

3.2 Display at Power "ON" and Initial Settings

Table 3-1 Setting items and initial values

Setting item	Parameter range	Initial value	INIT	*RST	Setting memory	Resume
<Measurement range (including Rdc)>						
Automatic selection	OFF(HOLD) ON	ON	←	←	○	○
Range	100mΩ to 1MΩ	100Ω	←	←	○	○
<Measurement signal>						
Frequency	1mHz to 5.5MHz	1kHz	←	←	○	○
Signal level (voltage)	0.01 to 5Vrms	1Vrms	←	←	○	○
Constant voltage drive (CV)	OFF ON	OFF	←	←	○	○
Minimum output impedance	6 25 100Ω	25Ω	←	←	○	○
Rd 25Ω upper limit range	1 100Ω	1Ω	←	←	○	○
Constant current level	1μ to 200mArms	1mArms	←	←	○	○
Constant current drive (CC)	OFF ON	OFF	←	←	○	○
Internal DC bias voltage	0 to 5V	0V	←	←	○	○
Internal DC bias output	OFF ON AUTO TRACK	OFF	←	←	×	×
Triggered drive	Continuous Sync.	Continuous	←	←	○	○
<Measurement speed>	RAP FAST MED SLOW VSLO	MED	←	←	○	○
<Averaging>						
ON/OFF	OFF ON	OFF	←	←	○	○
Count	1 to 256	1	←	←	○	○
<Trigger>						
Trigger source	INT MAN EXT BUS	INT (internal)	←	←	○	○
Trigger delay time	0.0000 to 999.9999 s	8ms	←	←	○	○
Continuous	OFF ON	ON	←	OFF	×	×
<Multi-measurement>						
(LIST) ON/OFF	OFF ON	OFF	←	←	×	○
Multi-measurement mode	SEquence STEPped	SEquence	←	←	×	○
Multi-measurement list						
Frequency	{Frequency OFF} x 32 steps	All OFF	×	×	×	○
Setting memory	{0 to 31 OFF} x 32 steps	All OFF	×	×	×	○
<Correction frequency range>						
Correction upper limit frequency	2kHz to 5.5MHz	2MHz	←	←	○	○
Correction lower limit frequency	1mHz to 100kHz	40Hz	←	←	○	○
<SPOT correction>						
ON/OFF	OFF ON	OFF	←	←	○	○
Frequency	(automatic)	All disabled	←	←	○	○
<OPEN correction>						
ON/OFF	OFF ON	OFF	←	←	○	○
Correction value (Primary & Secondary parameters)	±9.99999E+11 Y-equivalent	0, 0	←	←	△	○
Format of correction value	G-B Cp-G	G-B	←	←	○	○
<SHORT correction>						
ON/OFF	OFF ON	OFF	←	←	○	○
Correction value (Primary & Secondary parameters)	±9.99999E+11 Z-equivalent	0, 0	←	←	△	○
Format of correction value	Rs-X Ls-Rs	Rs-X	←	←	○	○

3.2 Display at Power "ON" and Initial Settings

Setting item	Parameter range	Initial value	INIT	*RST	Setting memory	Resume
<LOAD correction>						
ON/OFF	OFF ON	OFF	←	←	○	○
Correction value (Primary & Secondary parameters)	±9.99999E+11	1, 0	←	←	△	○
Standard value (Primary & Secondary parameters)	±9.99999E+11	1, 0	←	←	△	○
Format of standard value / correction value	Cp-D Cs-D Rp-Cp Rs-Ls Rs-X Z-θ	Rs-X	←	←	○	○
<Cable length>	0 1 2 4 m	0m	←	←	○	○
<Contact check>						
Contact check	OFF ON	OFF	←	←	○	○
Low capacitance check	OFF ON	OFF	←	←	○	○
Low capacitance limit	0 to 9.99999E-7 [F]	0	←	←	○	○
<Measured data>						
Measurement parameter automatic selection	OFF ON	ON	←	←	○	○
Kind of primary parameters	L C R Z Y G (REAL MLIN)	C	←	←	○	○
Equivalent circuit (primary parameter)	Series Parallel	Parallel	←	←	○	○
Equivalent circuit automatic selection	ON OFF	ON	←	←	○	○
Kind of secondary parameters	Q D θ X B Rs Rp G Lp Rdc(IMAG REAL)	D	←	←	○	○
Primary parameter deviation display format	Deviation Deviation %	Deviation	←	←	○	○
Primary parameter deviation display	OFF ON	OFF (ABS)	←	←	○	○
Primary parameter reference value	±9.99999E+11	0	←	←	○	○
Secondary parameter deviation display format	Deviation Deviation %	Deviation	←	←	○	○
Secondary parameter deviation display	OFF ON	OFF (ABS)	←	←	○	○
Secondary parameter reference value	±9.99999E+11	0	←	←	○	○
Dual measurement (Rdc and others)	OFF ON	OFF	←	←	○	○
Measurement function	FIMP FADM, etc.	FIMP	←	←	○	○
<Comparator>						
Comparator function	OFF ON	OFF	←	←	○	○
BIN1 sorting	OFF ON	ON	←	←	○	○
BIN2..14 sorting	OFF ON	OFF	←	←	○	○
Comparison of secondary parameter	OFF ON	ON	←	←	○	○
Primary parameter upper limit (value, ON/OFF)	±9.99999E+11, OFF ON	0,OFF (No Limit)	←	←	○	○
Primary parameter lower limit (value, ON/OFF)	±9.99999E+11, OFF ON	0,OFF (No Limit)	←	←	○	○
Secondary parameter upper limit (value, ON/OFF)	±9.99999E+11, OFF ON	0,OFF (No Limit)	←	←	○	○
Secondary parameter lower limit (value, ON/OFF)	±9.99999E+11, OFF ON	0,OFF (No Limit)	←	←	○	○
Primary parameter comparison format	Absolute value Deviation Deviation %	Absolute value	←	←	○	○

3.2 Display at Power "ON" and Initial Settings

Setting item	Parameter range	Initial value	INIT	*RST	Setting memory	Resume
Primary parameter deviation comparison reference value	(Common to deviation display)	0	←	←	○	○
<Limit comparison >						
Primary parameter limit comparison	OFF ON	OFF	←	←	○	○
Secondary parameter limit comparison	OFF ON	OFF	←	←	○	○
<Handler interface>						
AUX BIN function	OFF ON	OFF (Include)	←	←	○	○
Bin extension BIN10..14	OFF ON	OFF	←	←	○	○
TRIG polarity	Positive Negative	Positive	×	×	×	×
Setting/correction value memory recall target	SPOT correction Partial settings Settings Correction values Both	SPOT correction	←	←	○	○
Test mode	OFF ON ER	OFF	←	←	○	○
Test output	L H (for each pin)	(Depending on the pin)	←	←	○	○
<Beeper>						
Sounding selection	OFF ON	OFF	←	←	○	○
Sounding condition	FAIL PASS	FAIL	←	←	○	○
<Auxiliary display>	Status BINn-Limit Sec-Limit P-S-REF I-V Z-θ List	Status (BIN 1)	←	←	○	○
<Data transfer format>	ASCII Real (binary) Packed	ASCII	←	←	×	×
<Measured data buffer>						
BUF1, BUF2 data	Primary parameter Secondary parameter None	None, None	←	←	×	×
BUF1, BUF2, BUF3 feed	Send Not send	Not send (All)	←	←	×	×
BUF1, BUF2, BUF3 size	1 to 200, 1 to 200, 1 to 1000	200,200,1000	←	←	×	×
<Key lock>	OFF ON	OFF	←	←	×	×
<Interface>	(LAN is optional)					
Type	USB RS232 GPIB LAN	USB	×	×	×	⊙
GPIB address	0 to 30	2	×	×	×	⊙
RS-232 bit rate	4800 to 230400	9600	×	×	×	⊙
RS-232 terminator	CR LF CR LF	CR LF	×	×	×	⊙
RS-232 handshake	OFF SOFT HARD	OFF	×	×	×	⊙
LAN IP address	0.0.0.0 to 255.255.255.255	192.168.0.1	×	×	×	⊙
LAN subnet mask	0.0.0.0 to 255.255.255.255	255.255.255.0	×	×	×	⊙
LAN default gateway	0.0.0.0 to 255.255.255.255	0.0.0.0	×	×	×	⊙
<Setting/correction value memory>						
Content	-	Empty (no saving)	×	×	—	—
Recall target (at panel operation)	Settings Correction values Both	Setting	←	←	○	○

3.2 Display at Power “ON” and Initial Settings

Setting item	Parameter range	Initial value	INIT	*RST	Setting memory	Resume
<Others>						
Settling wait time during automatic adjustment	1ms to 99ms	20ms	←	←	○	○
Operation mode	Mode 0 1	Mode 0	×	×	×	◎

■ Remarks

Initial value Set when device is shipped from factory, or when full initialization is executed with the system setting menu.

INIT Set when initialization is executed with the initialize menu (**SHIFT** + [INIT]).

***RST** Set when *RST command of remote control is executed

← Same as left (initial values)

△ Function provided. However, it is saved not in the setting memory but in the correction value memory.

× Function not provided. (No influence)

○ Function provided.

◎ Function provided. However, it is saved independently from general resume target (○).

It cannot be set/query by the remote control.

The followings are out of the resume target:

- Measured data saved in the measured data buffer
- Latest measured data
- Range selected automatically
- Measurement parameters selected automatically
- Equivalent circuit selected automatically

3.3 Operation Tree

An operation tree when ZM2376 is operated from the panel is shown below.

For the expression of operations, see “3.5.2 Basic Key Operations”.

Operation Tree (1/4)

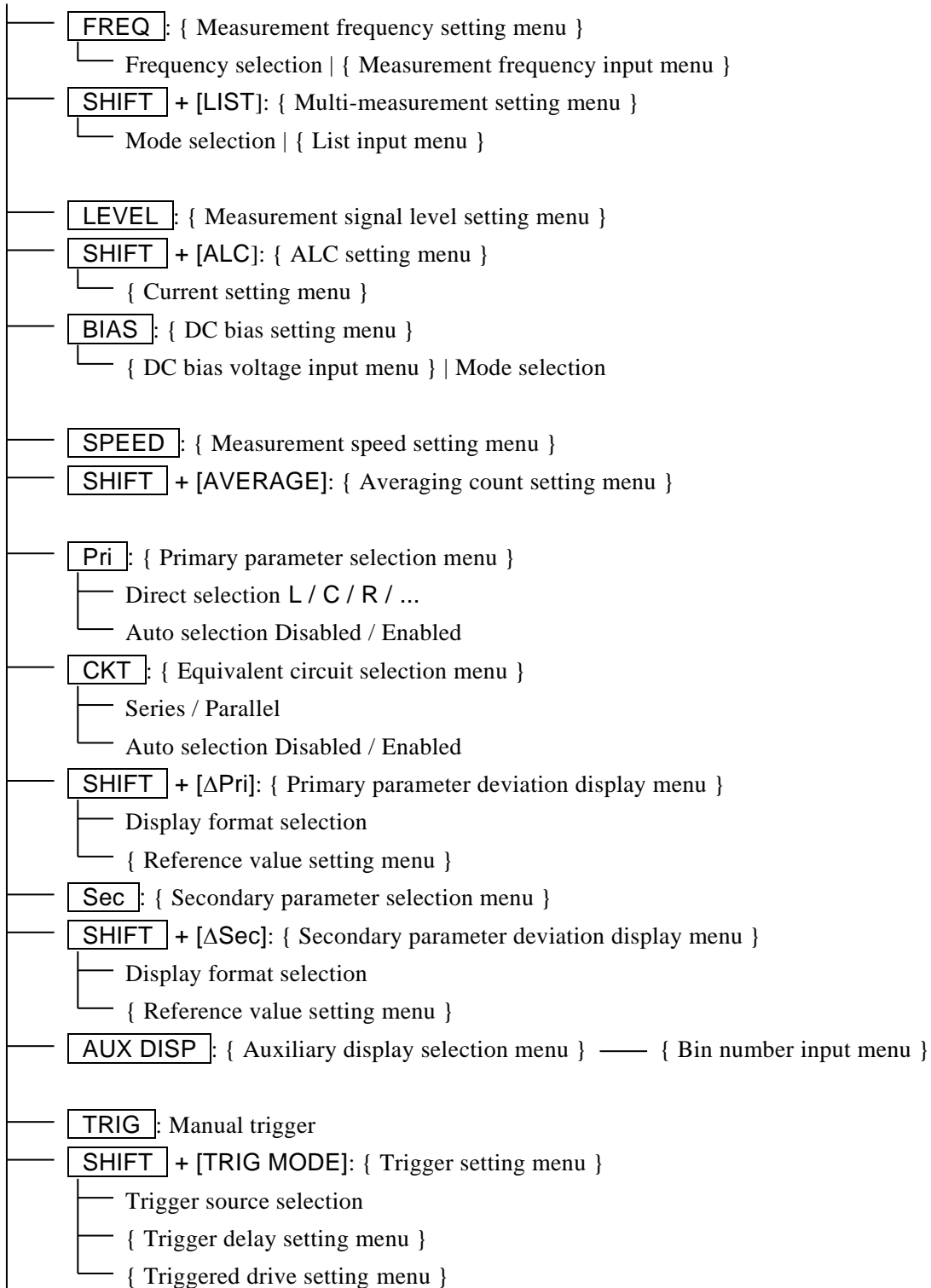

Continued

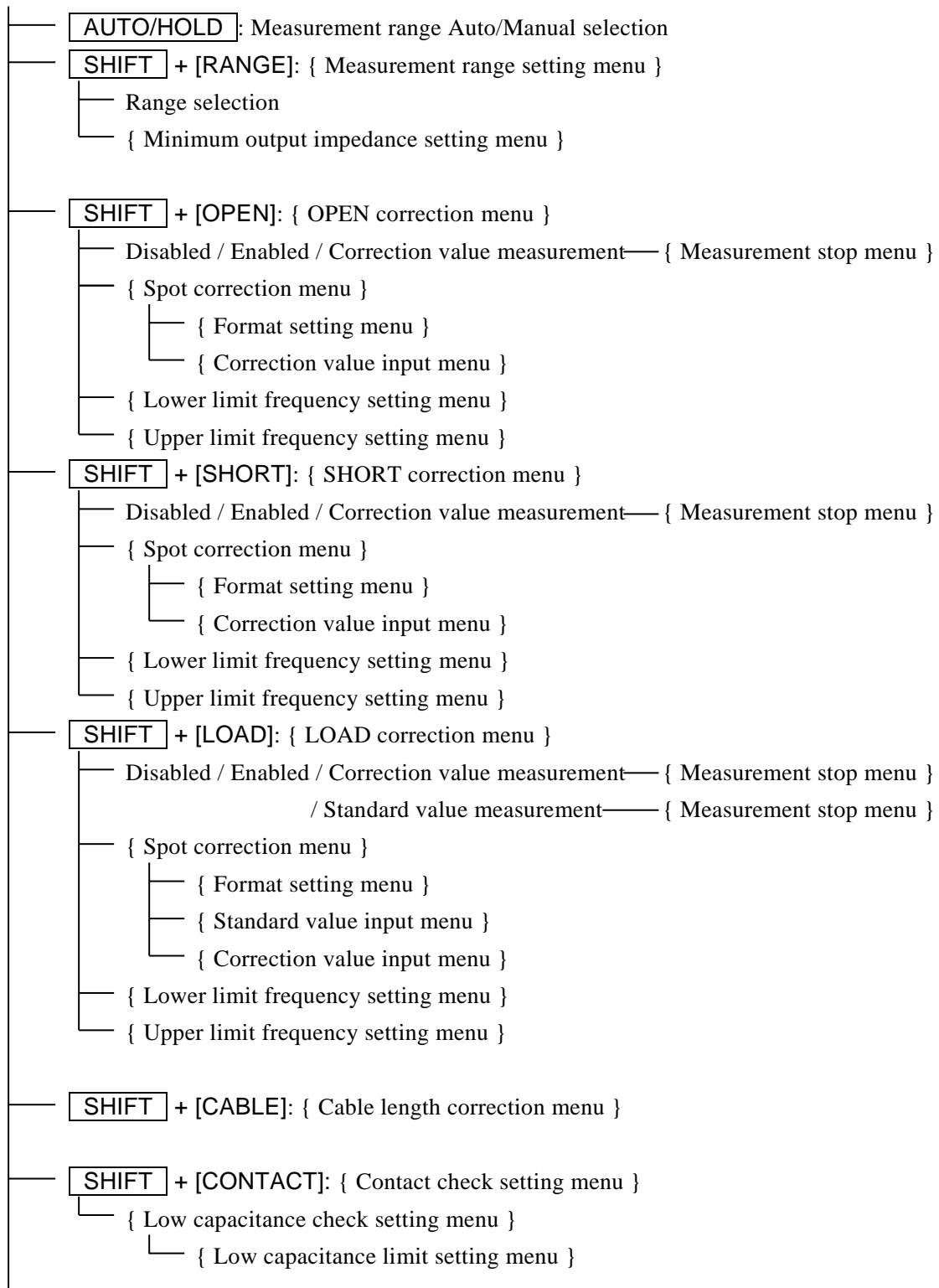

Continued

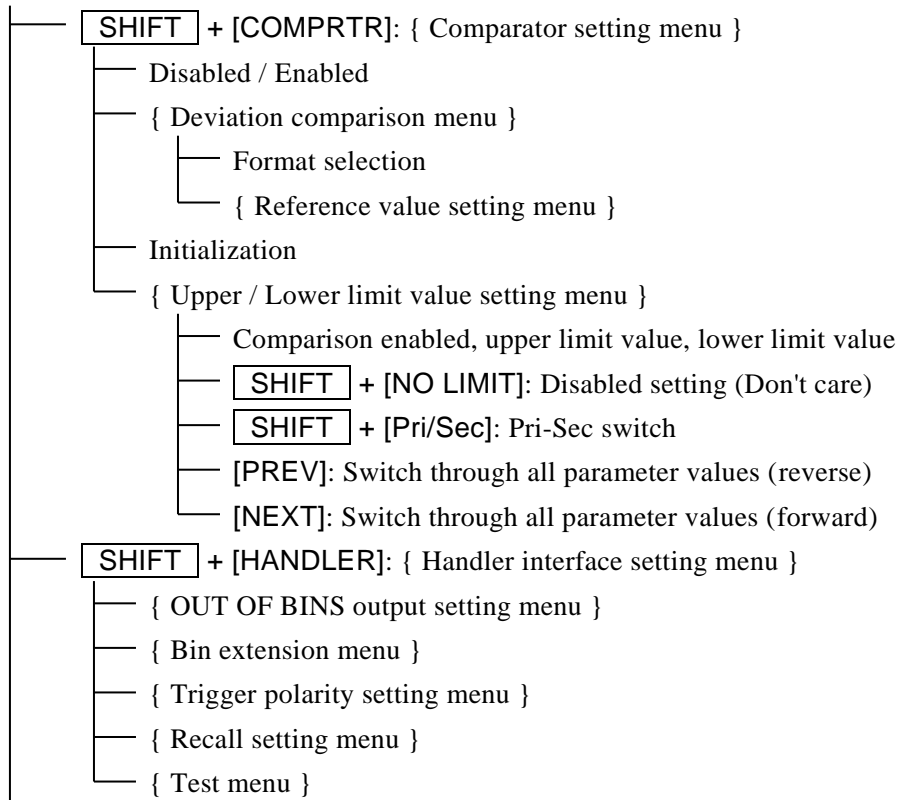

Continued

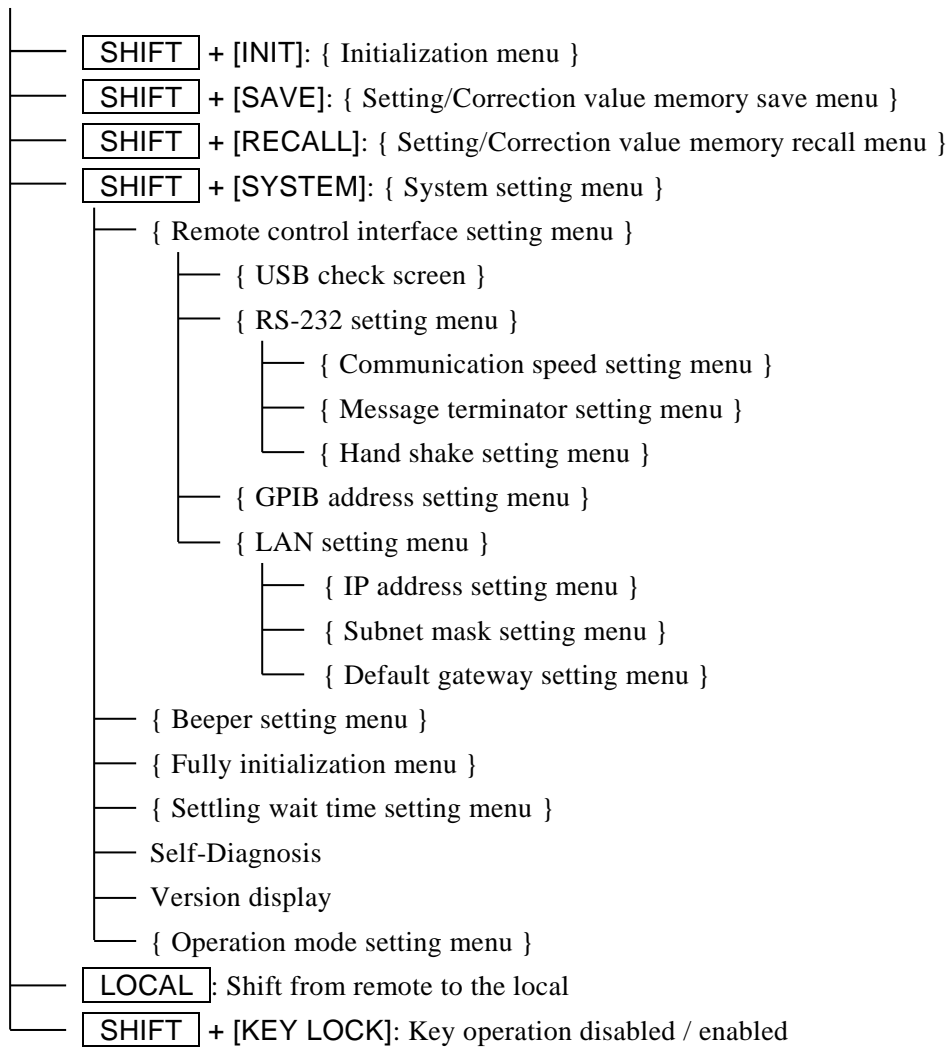

3.4 Connection of DUT

3.4.1 Measurement Terminals

■ Description of each terminal

H _{CUR}	Outputs the signal to drive the DUT.
H _{POT}	Measures the voltage applied to the DUT.
L _{POT}	Measures the voltage applied to the DUT.
L _{CUR}	Measures the current flowing in the DUT.
	Ground terminal to guard the DUT.

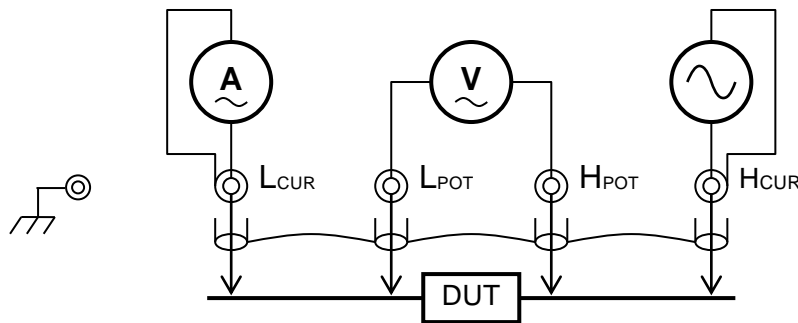

Connect total four outer conductors (shields) of each terminal together. Be sure to connect outer conductors (shields) of H_{CUR} and L_{CUR} terminals, since the signal currents return through these conductors.

Figure 3-3 Functions of measurement terminals

■ Measurement terminals when power is OFF

Even when the power is in OFF state, the measurement terminals are connected to internal circuits.

⚠ CAUTION

- Do not give signals from outside to the measurement terminals. Do not give signals from outside even when the power is OFF. Otherwise, ZM2376 may be damaged.
- Do not connect the charged capacitor. When the DUT could have been charged, discharge the DUT completely before connection. Discharging the DUT to the measurement terminals may damage the ZM2376. (When connecting a capacitor which is charged to a voltage approximately equal to the bias voltage, the ZM2376 will not be damaged since the charge-discharging current is small.)

■ Measurement signals

Main specifications of measurement signals are as follows:

Signal level	Voltage	10mVrms to 5Vrms (ALC possible)
	Constant current	1 μ Arms to 200mArms (range depends on measurement range, etc.)
		Max. 7.1Vpk also including DC bias is outputted.
Output impedance		About 6 Ω / 25 Ω / 100 Ω (depending on measurement range, frequency, etc.)
Max. drive current		About 200mArms

3.4.2 Connection to DUT

Connect ZM2376 and DUT with 4-terminal (4-terminal-pair) as shown below to avoid the influence of contact resistance.

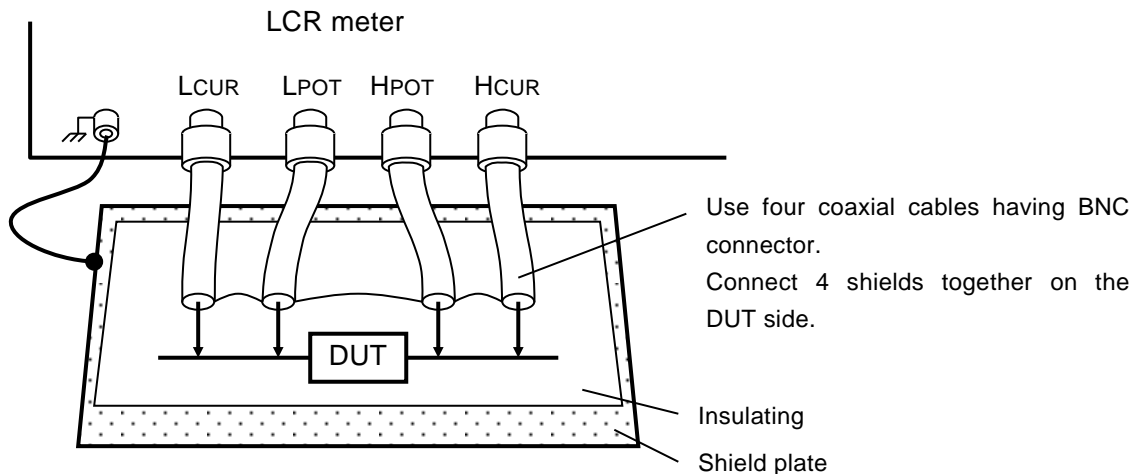

When the measured value is unstable due to a noise, lay a metallic plate connected to the outer conductor (shields) of measurement cables or the case under the DUT for shielding.

Figure 3-4 Connection to DUT

In the measurement of high impedance, shielding around the DUT can restrict variation of measured value. In a simplified method, place an insulating plate on the top surface of ZM2376, and measure the DUT on it.

The ZM2376 cannot measure the grounded DUT. Both ends of DUT must be both insulated from the grounding.

When commercially available test fixture or test lead is used, refer to the instruction manual of these products. The product in which the shields of respective terminals are not connected cannot be used together with the ZM2376.

3.4.3 Precautions on Connection

■ Handling of shields

Connect the shields (outer conductor) of connection cables, 4 pieces together on the DUT side. The current that flows from H_{CUR} terminal through DUT to the L_{CUR} terminal returns to the H_{CUR} terminal through the shield. Measurement will fail unless this return path is provided. To stabilize reference potential in the voltage detection part, connect the voltage cable shield and the current cable shield. Do not connect the connection cable shields to the ground. If grounded, a noise will mix in due to electromagnetic coupling by a ground loop or common impedance coupling with other equipment.

■ Electromagnetic interference prevention and electromagnetic susceptibility improvement

In the cable connection with the DUT, put four coaxial cables together in the vicinity of measurement terminals of LCR meter, and attach the common mode choke. It can reduce high-frequency radiation field disturbance received from the periphery, or reversely disturbance given to the periphery.

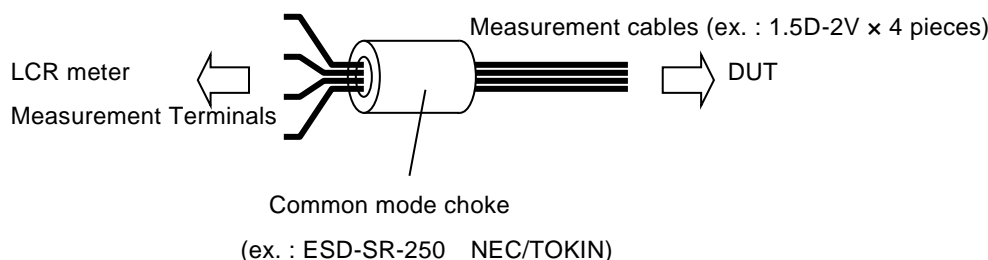

■ Selection of cables

In the measurement of low impedance such as capacitors having large capacitance, a voltage drop of L_{CUR} cable causes a common mode noise, increasing the measurement error. This error cannot be corrected by the cable length correction. In a narrow measurement range, the error can be reduced by the LOAD correction and it is therefore recommended to use thick and short current cables (particularly for L_{CUR}) so as to reduce the resistance of cable inner conductor to 0.5Ω or less per cable. Note that the circuit (including probe resistance and contact resistance) between cables and DUT has similar influence.

In the measurement of high impedance such as capacitors having small capacitance, using long connection cables increases the error due to capacitance of the cables. This error can be corrected by the cable length correction. However, correctable cables are coaxial cables of characteristic impedance 50Ω (capacitance: about 105pF/m) having the specified length. When the cables used are out of specification or when an error is large due to the DUT to earth capacitance, the error can be reduced by the LOAD correction only in a narrow measurement range.

If cables substantially exceeding the specified length are used, or if DUT to earth capacitance is large, the ZM2376 operation may become unstable or the measurement dispersions may become large due to the influence of resistance value or capacitance of cable inner conductor. Note that particularly the capacitance to ground on the L side is more likely to be influential. It may not be always true depending on DUT or resistance of cables, but a total of capacitance of four connection cables and capacitance to earth of DUT should be reduced to about 2000pF or less.

■ Cable routing and electromagnetic induction

Presence of noise sources such as motors or power transformers that generate large magnetic field near the device causes a noise to get mixed in due to electromagnetic induction. To avoid this, perform the wiring so that a large loop is not made.

If electromagnetic induction occurs between current cable and voltage cable, an error will increase in the low impedance measurement or an error will vary with the movement of cables. Twisting two cables each between current cable and current cable, and between voltage cable and voltage cable, or twisting four cables together so that the voltage cables are arranged diagonally and also the current cables are arranged diagonally as viewing the cross section can reduce an error due to electromagnetic induction between cables.

■ Noise mixing in due to electrostatic coupling

If inner conductor of L_{CUR} and L_{POT} cables are exposed, a noise will mix in due to electrostatic coupling with noise sources. Provide an electrostatic shield or keep peripheral potential constant. Be sure to connect the ZM2376 case to the ground. Using 3-pole power cord, connect ZM2376 to the 3-pole power outlet having a protective grounding contact, so that the device is connected to the ground. Unless grounded, not only a hazardous situation occurs but also the potential of case varies according to the power frequency or line noise, thus allowing a large noise to mix in.

■ Avoidance of 2-terminal connection

Connecting between L_{CUR} and L_{POT} cables or between H_{CUR} and H_{POT} cables in the middle of wiring disables the 4-terminal connection. Since such a connection is equivalent to the 2-terminal connection, it is affected by the contact resistance. In the measurement of low impedance or measurement of small dissipation factor D (or small equivalent series resistance ESR), when the contact resistance is not negligible, connect four connection cables independently to the DUT.

■ Influence of contact resistance

An error caused by the contact resistance with DUT can be restricted by 4-terminal connection, but since the input impedance of voltage measurement terminals is not infinite, there may be some influence. Particularly when the contact resistance exceeds 10Ω , prior evaluation of additional error should be made before use.

3.5 Basic Operations

3.5.1 Outline of Measurement Screen

During the measurement, the measured value and main settings are displayed on the LCD display (40 characters x 2 lines) of the front panel. Basic contents of display are as shown below.

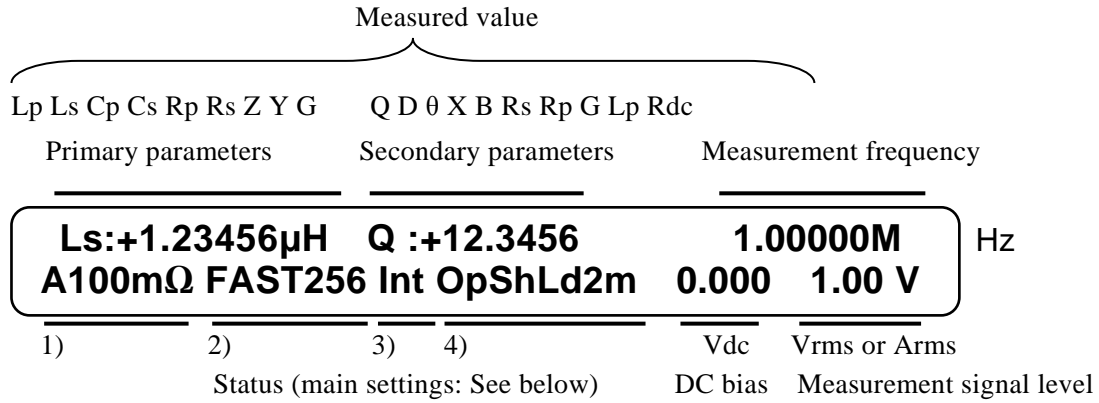

1) RANGE: Measurement range

{ Auto | Hold } and impedance measurement range

2) SPEED/AVERAGE: Measurement speed and averaging

{ RAP | FAST | MED | SLOW | VSLO } and averaging count

3) TRIG SOURCE:

{ Int | Man | Ext | Bus }

4) CORRECTION:

Op	OPEN	}	(Only the enabled corrections are displayed)
Sh	SHORT		
Ld	LOAD		
Xm	Cable length {0m 1m 2m 4m}		

{ } indicates that either one of options delimited with | is displayed.

3.5.2 Basic Key Operations

■ Primary function

Press each key on the front panel, and the function written on the key top will operate.

TTT key: Indicates the key with “TTT” written on the key top.



■ Secondary function

If the **SHIFT** key (blue) is pressed, the secondary function written with blue characters above the key becomes active. At this time, SHIFT is displayed at the bottom right of character display. In this state, press any key, and the secondary function of that key will operate.

If the secondary function operates once or the **SHIFT** key is pressed again, the SHIFT state is cancelled.

SHIFT + [AAA] Indicates that after pressing the **SHIFT** key, the key with AAA (blue) written above the key is pressed.

TTT | [BBB] key Indicates the key with TTT written on the key top and BBB written above or under the key.

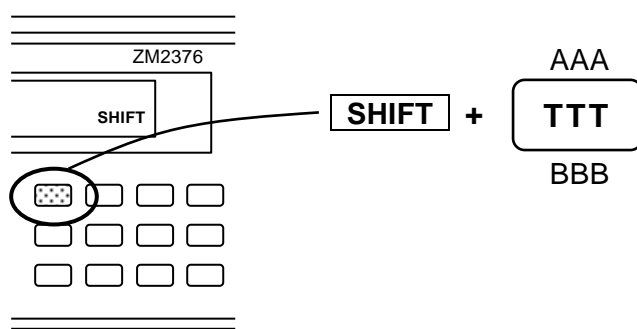

■ Tertiary function

The tertiary function (BBB) written under the key operates according to the operation flow or situations at that time.

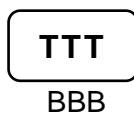

■ Operation of setting menu

Depending on the key operations, the setting menu will be displayed to select a function or set a numeric value.

Function selection: When options are displayed on the lower line of the setting menu, an option can be selected by pressing a numeric key associated with each option.

Options that cannot be accommodated in one line are displayed over multiple pages. The pages can be switched with **[BS]** | **[PREV]** key and **[EXP]** | **[NEXT]** key.

Even an option that exists on the page not displayed, it can be selected with the associated numeric key.

Parameter name and current settings

Parameter_name: Value1	(Value2)
0)alt1 1)alt2 2)alt3	Comments >NEXT

Options

Indicates that more options exist on another page

Numeric value input: When the cursor is located at the parameter to which a numeric value can be entered, the comments such as a range of settable values are displayed on the lower line of the setting menu. The cursor is displayed by blinking the digit. The following key operations are possible.

- Numeric keys, decimal point key, sign key : Input a numeric value.
- **[EXP]** + [x]: Input the exponential part (x = p, n, μ , m, k, M) of a numeric value (to enter the value (**[ENTR]** need not be pressed).
For details  Input of exponential part (Mentioned later)
- **[ENTR]** key: Enters the input value.
- **[BS]** key: Clears a value being input, one character at a time from the last.
- **[SHIFT]** + **[CE]**: Clear a value being input, all at once.

Upon clear of a value being input, the currently set value is displayed.

For the menu that needs multiple parameters, the parameters to be set can be switched with **[BS]** | **[PREV]** key and **[EXP]** | **[NEXT]** key.

Parameter name and current settings

Parameter_name: Value1	(Value2)
Range of value	Comments

Available ranges

Input of exponential part

EXP + [x] Indicates that after the **EXP** key is pressed, the key expressed as x on the right side is pressed.

If the **EXP** key is pressed during input of a numeric value, EXP is displayed at the bottom right of display, waiting for input of exponential part. In this state, press any key, so that exponential part x written on the right side of that key can be input.

Available exponential parts: p (10^{-12}), n (10^{-9}), μ (10^{-6}), m (10^{-3}), k (10^3), M (10^6).

If the exponential part is input or the **EXP** key is pressed again, the exponential part input waiting state is cancelled.

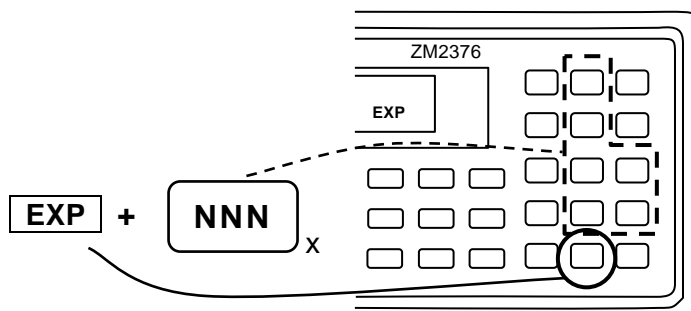

EXIT operation With the setting menu, if the **ENTR** | **[EXIT]** key is pressed without setting or selecting a value, one-previous menu is returned. However, depending on the parameter, the setting menu is closed and the measurement screen comes back. There are some parameters that automatically returns to one-previous menu or measurement screen without executing the EXIT operation, after a value was set or selected.

■ **Reset of error message**

An error message may be displayed when, for instance, the input value exceeds the setting range.

The error message can be reset by pressing any key. After confirming the contents of an error, press the **ENTR** | **[EXIT]** key at the bottom right for instance to reset the error message.

3.5.3 Simplified Operating Method When You Use “ZM2376” for the First Time

This section describes the simplified operating method when you use the ZM2376 for the first time.

Do not connect the handler interface and remote control interface.

Perform operation through the procedure mentioned below:

- 1) Unlock the key lock
- 2) Initialization
- 3) Setting of measurement conditions
- 4) Connect and measure the DUT.

With the factory default settings, unlocking of key lock and initialization can be omitted.

■ Unlock the key lock

When the KEY LOCK lamp lights up, first press the **SHIFT** + **[KEY LOCK]** keys to unlock the key lock. In concrete terms, after pressing the **SHIFT** key, press the **LOCAL** | **[KEY LOCK]** key with KEY LOCK written above the key.

■ Initialization

Press the **SHIFT** + **[INIT]** keys to display the initialize menu, and press the **1** key to return to the initial setting state.

When you use the ZM2376 that has already been set variously, performing the initialization makes later operations easy. The contents saved in the setting/correction value memory are not initialized by this operation.

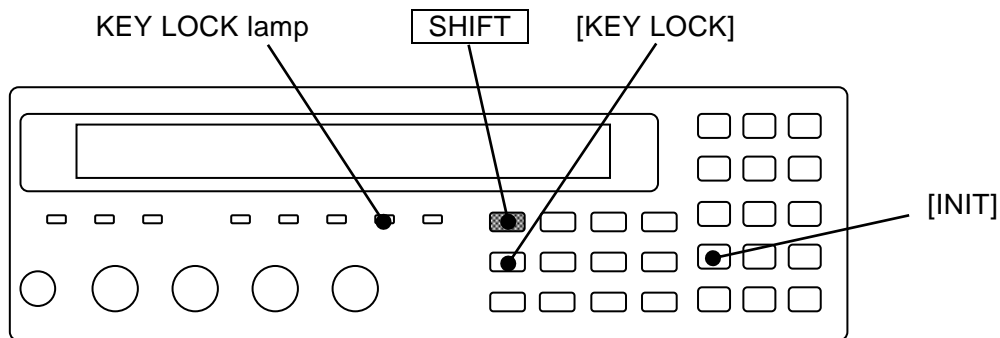

■ Selection of measurement parameters

• Selection of Primary Parameters

Press the **Pri** key to display the primary parameter selection menu (see below), and select a primary parameter with a numeric key. Also, the measurement parameters (primary and secondary) can be selected automatically.

For details  “3.5.5.1 Selection of Primary Parameters”

Primary parameter : C	Auto:OFF	Current setting
0)Auto OFF 1)ON 2)L 3)C 4)R 5)Z 6)Y 7)G		Options

If either L, C, or R is selected, the equivalent circuit selection menu is displayed.

• Selection of primary parameter equivalent circuit

For the L, C, and R, specify the equivalent circuit additionally.

Press the **CKT** key to display the equivalent circuit selection menu (see below), and select Parallel (suffix p) or Series (suffix s) with a numeric key. Automatic selection is also possible.

For details  “3.5.5.2 Setting of Equivalent Circuit”

Equivalent CKT : Series	Auto:OFF	Current setting
0)Auto OFF 1)ON 2)Parallel 3)Series		Options

• Selection of secondary parameter

Press the **Sec** key to display the secondary parameter selection menu (see below), and select a secondary parameter with a numeric key. The options can be switched to those on the second page with the **EXP** | [NEXT] key.

For details  “3.5.5.3 Setting of Secondary Parameters”

Secondary parameter : D	Current setting
0)Q 1)D 2)θ 3)X 4)B 5)Rs >NEXT	Options (first page)
6)Rp 7)G 8)Lp 9)Rdc <PREV	Options (second page)

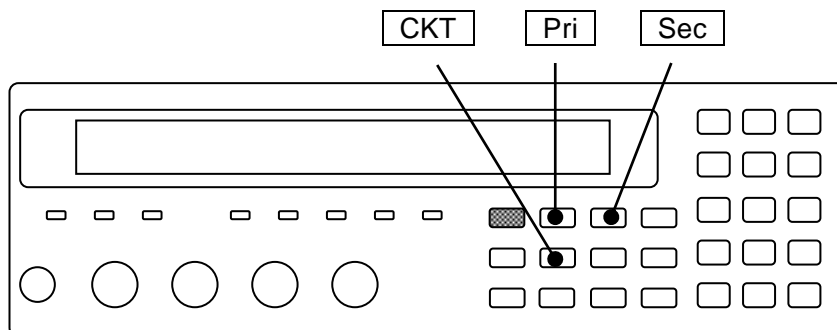

■ Setting of measurement conditions

• Measurement frequency

Press the **FREQ** key to display the measurement frequency setting menu, and select the frequency with a numeric key or set a numeric value.

• Measurement signal level

Press the **LEVEL** key to display the measurement signal level setting menu, and set the voltage.

• Measurement speed

Press the **SPEED** key to display the measurement speed setting menu, and select the measurement speed with a numeric key.

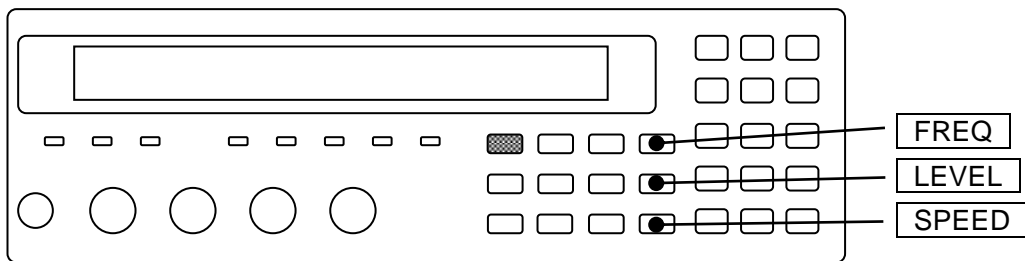

- Trigger source

Press the **SHIFT** + **[TRIG MODE]** keys to display the trigger setting menu (see below), and set the trigger source with a numeric key.

TRIG SRC:Ext Delay=99.0000s SRC Sync=ON	Current setting
0)Int 1)Man 2)Ext 3)Bus 4)Delay 5)S.Sync	Options

Int Internal. Automatic repetitive measurement (default value)
 Man Manual. Press the **TRIG** key on the front panel to trigger the measurement.
 Ext External. The trigger signal of handler interface is used to trigger the measurement.
 Bus Remote control

- Measurement range

The default setting is automatic selection.

Press the **AUTO/HOLD** key to switch between Automatic selection (Auto) and Manual selection (Hold).

Press the **SHIFT** + **[RANGE]** keys to display the measurement range setting menu (see below), and press a numeric key (**0** key or **1** key) to change the measurement range manually. The range is held (manual selection).

RANGE : Manual 1kΩ Rd : 25Ω-1	Current setting
0)DOWN 1)UP 100mΩ to 1MΩ 2)Rd-min	Options

When a measurement range value is large, it is approximate the lower limit of measurement range, or when a value is small, it is approximate the upper limit of measurement range.

For details  “Table 3-2 Measurement range list”

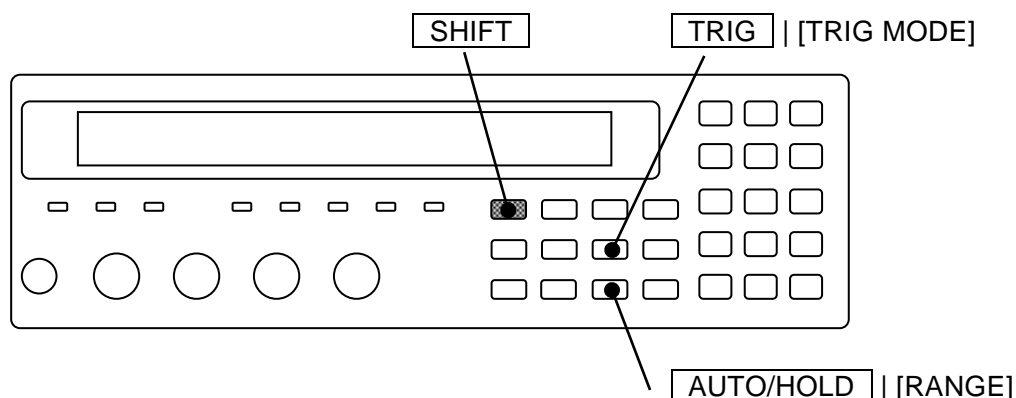

- Connection of DUT and measurement

- Connection of DUT

Connect the LCR meter to the DUT by referring to “3.4 Connection of DUT”.

- Manual trigger

When you set the trigger source to Manual (Man) and press the **TRIG** key, the trigger signal is applied and the measurement is executed once.

3.5.4 Initialization

There are two types of initialization as described below.

■ Initialization of current settings

SHIFT + [INIT]

Press the **SHIFT** + [INIT] keys to display the initialize menu, and press the **1** key, so that currently used settings and correction values are reset to the default values.

Upon initialization, the initialization completion message “Done” is displayed, and then the measurement screen comes back.

Done

The contents of the setting/correction value memory and the multi-measurement list are not initialized.

If the EXIT operation is performed without pressing the **1** key, the initialization is not performed, and the measurement screen comes back.

Only the settings cannot be initialized without initializing correction values. Save necessary correction values in the correction value memory.

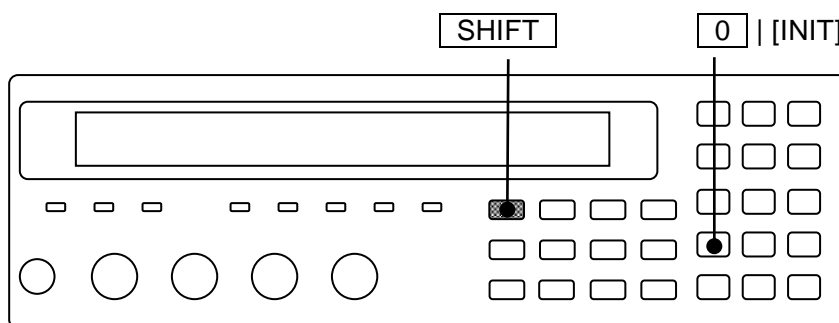

■ Full initialization

To reset all settings except operation modes to the factory default values, perform full initialization. The setting/correction value memory and the multi-measurement list are also initialized.

For details [☞](#) “4.14 Initializing of All Settings”

3.5.5 Setting of Measurement Parameters

The ZM2376 can display two parameters (primary parameter and secondary parameter) at the same time.

In general, L, C, R values are different between series equivalent circuit and parallel equivalent circuit, and therefore select appropriate equivalent circuit according to the nature and circuits used of the DUT.

3.5.5.1 Selection of Primary Parameters

Pri

Press the **Pri** key to display the primary parameter selection menu (see below), and select a primary parameter with a numeric key.

Primary parameters	Auto selection function	
Primary parameter : C	Auto:OFF	Current setting
0)Auto OFF 1)ON 2)L 3)C 4)R 5)Z 6)Y 7)G		Options

Auto OFF	Disables automatic selection of measurement parameters.
ON	Enables automatic selection of measurement parameters.
L	Inductance L_p or L_s (unit: Henry "H")
C	Capacitance C_p or C_s (unit: Farad "F")
R	Resistance R_p or R_s (unit: Ohm " Ω ")
Z	Magnitude of impedance $ Z $ (unit: Ohm " Ω ")
Y	Magnitude of admittance $ Y $ (unit: Siemens "S")
G	Conductance indicated with parallel equivalent circuit G_p (unit: Siemens "S")

If a parameter other than L, C, and R is selected or the EXIT operation is performed, the measurement screen comes back.

If either L, C, or R is selected, the equivalent circuit selection menu is displayed.

If it is not necessary to change the equivalent circuit setting, you can use the EXIT operation to return to the measurement screen.

If primary parameter is set to G, automatic selection of equivalent circuit is disabled and the parallel equivalent circuit is set.

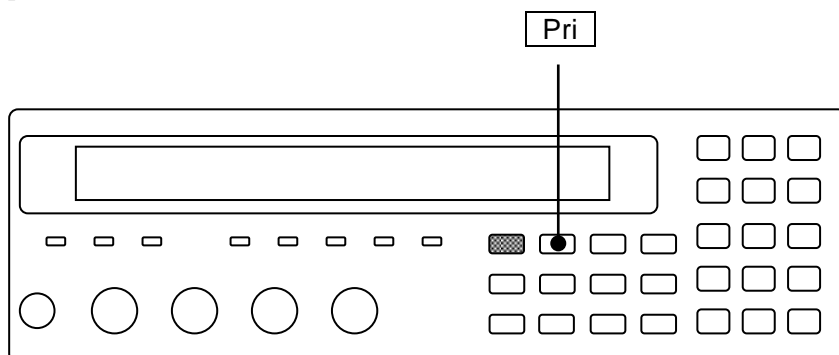

Each display range of primary parameters is as follows:

L	$\pm(0.000\text{nH} - 999.999\text{MH})$
C	$\pm(0.00000\text{pF} - 9.99999\text{kF})$
R	$\pm(0.000\text{m}\Omega - 999.999\text{M}\Omega)$
Z	$0.000\text{m}\Omega - 999.999\text{M}\Omega$
Y	$0.00\text{nS} - 9.99999\text{kS}$
G	$\pm(0.00\text{nS} - 9.99999\text{kS})$

The display range is limited by the measurement range.

The display range of L and C varies depending on the frequency.

■ Automatic selection of measurement parameters

Automatic selection rule of measurement parameters is as follows:

Phase angle θ of impedance	Primary parameters	Secondary parameters
+30 to +120°	L	Q
-30 to +30°	R	Q
-120 to -30°	C	D
Others	Z	θ

When a measurement parameter is automatically selected, the primary parameter, secondary parameter, and equivalent circuit are automatically selected based on the phase angle or magnitude of impedance. When the primary parameter is other than L, C, R, and Z, if a measurement parameter is automatically selected, immediately after that, Z is selected as a primary parameter.

If a specific primary parameter, secondary parameter, or equivalent circuit is set, or if automatic selection of equivalent circuit is disabled, automatic selection of measurement parameter is disabled and the primary parameter, secondary parameter, and equivalent circuit at that time are set.

■ Negative display of L, C, R

From the relation of reactance $X=\omega L=-1/(\omega C)$ and susceptance $B=\omega C=-1/(\omega L)$, (here, $\omega=2\times\pi\times\text{frequency}$), when $\theta > 0$ ($X > 0$), C is smaller than 0 ($C < 0$). Also, when $\theta < 0$ ($B > 0$), L is smaller than 0 ($L < 0$).

From the relation of $R=|Z|\cos\theta$, if $\theta > +90^\circ$ or $\theta < -90^\circ$ due to a measurement error, R is smaller than 0 ($R < 0$).

■ Parameters that can be selected by remote control only

By remote control, the followings can be specified, in addition to L, C, R, Z, Y, and G.

For details  ZM2376 Instruction Manual (Remote Control)

:CALCulate1:FORMat command

Lp, Ls	Inductance with equivalent circuit specified to parallel or series
Cp, Cs	Capacitance with equivalent circuit specified to parallel or series
Rp, Rs	Resistance with equivalent circuit specified to parallel or series
REAL	Real part of immittance (Rs or Gp. Either one is displayed as measured value)
MLIN	Magnitude of immittance ($ Z $ or $ Y $. Either one is displayed as measured value)

Impedance is a concept combining impedance and admittance.

If these are selected, automatic selection of measurement parameter and equivalent circuit is disabled.

3.5.5.2 Setting of Equivalent Circuit

CKT

Press the **CKT** key to display the equivalent circuit selection menu (see below), and select parallel (suffix p) or series (suffix s) with a numeric key.

Equivalent circuit	Auto selection function	
0)Auto OFF	1)ON	2)Parallel
3)Series	Auto:OFF	Current setting
		Options

- Auto OFF Disables automatic selection of equivalent circuit.
- ON Enables automatic selection of equivalent circuit.
- Parallel Parallel equivalent circuit (automatic selection is disabled)
- Series Series equivalent circuit (automatic selection is disabled)

If a setting is made or the EXIT operation is performed, the measurement screen comes back.

AUTO CKT lamp

The AUTO CKT lamp lights up when automatic selection of equivalent circuit is enabled.

When the primary parameter is L, C, R, Z, or Y, the equivalent circuit can be specified or its automatic selection function can be used. However, |Z| and |Y| values do not depend on the equivalent circuit.

If automatic selection of equivalent circuit is enabled, the equivalent circuit is automatically selected based on the automatic selection rule listed below when the primary parameter is L, C, or R.

Automatic selection rule			Equivalent circuit
L	C	R	
$ Z \leq 1k\Omega$	$ Z \leq 1k\Omega$	$\theta \geq 0$	Series
$ Z > 1k\Omega$	$ Z > 1k\Omega$	$\theta < 0$	Parallel

If the primary parameter is set to other than L, C, and R, automatic selection of equivalent circuit is as follows.

Primary parameters	[:SENSE]:FUNCTION[:ON]	Equivalent circuit	Automatic selection
Z, Y	(Don't care)	Last value retained	Last value retained
Rs, Cs, Ls	(Don't care)	Series	Disable
Rp, Cp, Lp, G	(Don't care)	Parallel	Disable
REAL, MLIN	FIMPedance	Series	Disable
	FADMittance	Parallel	Disable

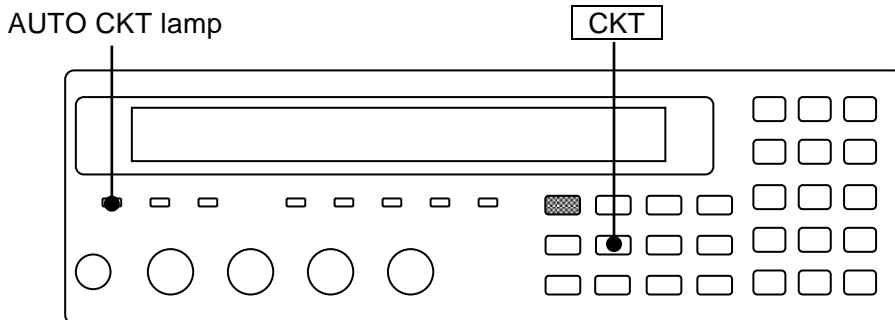

3.5.5.3 Setting of Secondary Parameters

Sec

Press the **Sec** key to display the secondary parameter selection menu (see below), and select a secondary parameter with a numeric key.

Secondary parameter : D						Current setting	
0)Q	1)D	2)θ	3)X	4)B	5)Rs	>NEXT	Options (first page)
6)Rp	7)G	8)Lp	9)Rdc			<PREV	Options (second page)

Q	Quality factor (=1/D)
D	Dissipation factor (= tanδ)
θ	Phase angle of impedance (unit: degree “°”)
X	Reactance Xs expressed with series equivalent circuit (unit: Ohm “Ω”)
B	Susceptance Bp expressed with parallel equivalent circuit (unit: Siemens “S”)
Rs	Resistance Rs expressed with series equivalent circuit (= ESR, unit: Ohm “Ω”)
Rp	Resistance Rp expressed with parallel equivalent circuit (unit: Ohm “Ω”)
G	Conductance Gp expressed with parallel equivalent circuit (unit: Siemens “S”)
Lp	Inductance Lp expressed with parallel equivalent circuit (unit: Henry “H”)
Rdc	Direct-current resistance Rdc (unit: Ohm “Ω”)

Any secondary parameters can be selected regardless of a setting of equivalent circuit.

If a setting is made or the EXIT operation is performed, the measurement screen comes back.

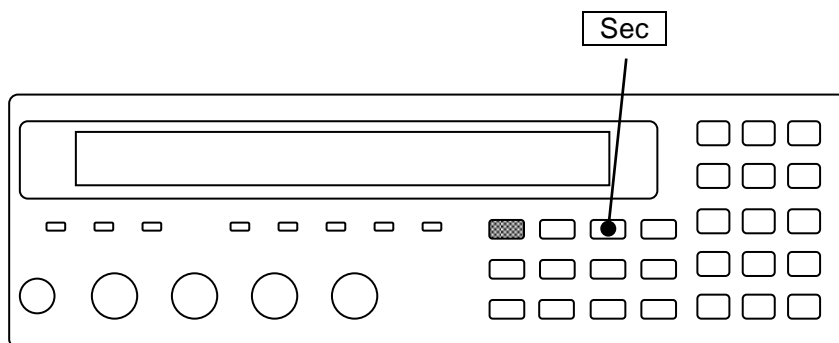

A display range of each secondary parameter is as follows:

Q, D	±(0.00000 - 99999.9)
θ	±(0.000° - 180.000°)
Rs, Rp, X, Rdc	±(0.000mΩ - 999.999MΩ)
G, B	±(0.00nS - 9.99999kS)
Lp	±(0.000nH - 999.999MH)

The display range is limited by the measurement range.

■ Negative display of Q, D, R, G

When the phase angle of impedance $\theta > +90^\circ$ or $\theta < -90^\circ$ due to a measurement error, the loss angle seems to be a negative value, and thus the Q, D, Rs (ESR), Rp, and G become negative values. Also, Rdc may become a negative value due to a measurement error of voltage or current.

■ Parameters that can be selected by remote control only

The following options can be selected by remote control only. They cannot be selected from the panel.

For details  ZM2376 Instruction Manual (Remote Control)

:CALCulate2:FORMat command

IMAG Imaginary part of immittance (X or B)

REAL Real part of immittance (either of Rs, G, or Rdc)

Immittance is a concept combining impedance and admittance.

■ DC (Direct-current) resistance Rdc

When Rdc is selected, ZM2376 measures the DC resistance after measuring the AC impedance. This function is mainly intended to measure the DC resistance of coil, and is not suited for the measurement of the insulation resistance of capacitor.

When the DC bias output is turned on, the DC resistance Rdc cannot be selected.

3.5.6 Setting of Basic Measurement Conditions

3.5.6.1 Measurement Frequency

The measurement frequency is displayed at the top right of measurement screen.

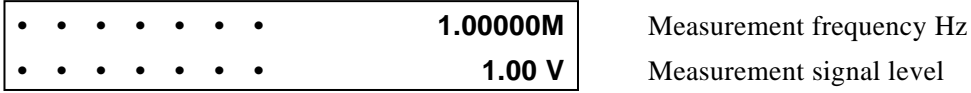

FREQ

Press the **FREQ** key to display the measurement frequency setting menu.

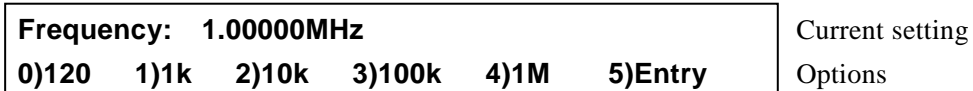

120	120Hz
1k	1kHz
10k	10kHz
100k	100kHz
1M	1MHz
Entry	Displays the measurement frequency input menu to input a numeric value.

If a setting is made or the EXIT operation is performed, the measurement screen comes back.

Entry: The measurement frequency input menu is as follows.



The setting resolution is 6 digits (1mHz when < 100Hz).

If a setting is made or the EXIT operation is performed, one-previous menu comes back.

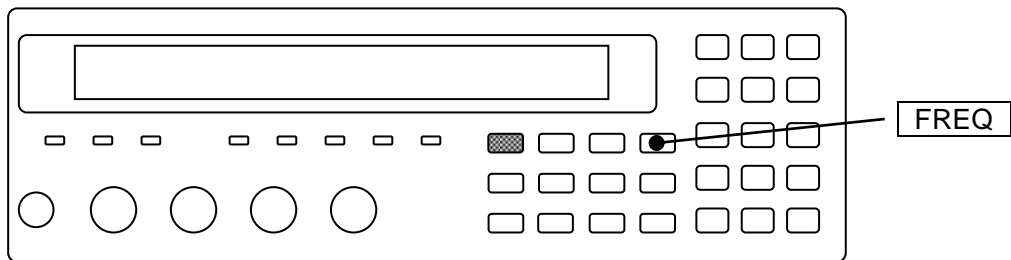

3.5.6.2 Measurement Signal Level

The measurement signal level is displayed at the bottom right of measurement screen.

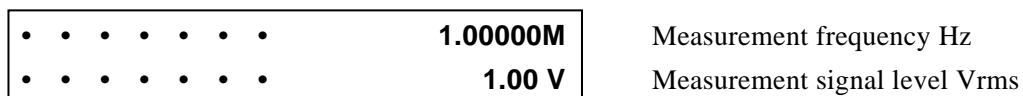

LEVEL

Press the **LEVEL** key to display the measurement signal level setting menu.



The setting resolution is 3 digits (1mV when < 100mV).

Though the value is an RMS value (unit: Vrms), it is simply displayed as V.

If a setting is made or the EXIT operation is performed, the measurement screen comes back.

If the measured value varies due to noise mixing, you can reduce the variation by increasing the measurement signal level.

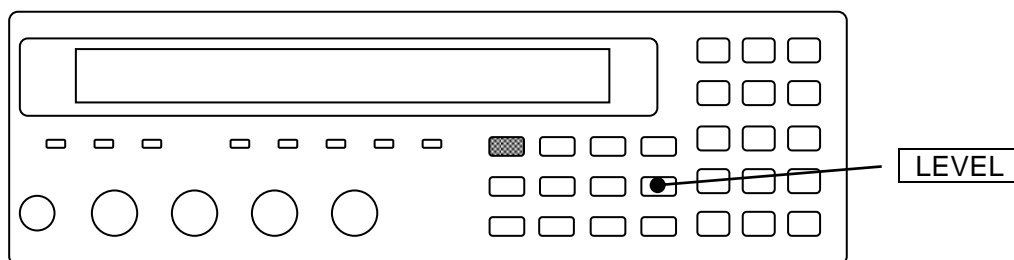

For the direct-current resistance Rdc, the voltage and current are measured with two measurement signals of about +1.4V and -1.4V, and Rdc is obtained from a difference of them, regardless of a setting of measurement signal level.

3.5.6.3 Measurement range

Set the measurement range according to the impedance of DUT.

Current measurement range setting is displayed at the bottom left of measurement screen.

• • • • •
A100Ω FAST256 Int OpShLd1m • • • • •
 RANGE

A Auto: Measurement range Auto selection

H Hold: Measurement range is held for manual selection

100Ω Current measurement range (100mΩ to 1MΩ)

Table 3-2 Measurement range list 1/4 (Rd-min = 25Ω-1 initial value)

Rd: Output impedance, Rd-min: Minimum output impedance

Measurement range	Recommended range	Measureable range	Rd	Restrictions
1MΩ	1MΩ - 11MΩ	900kΩ -	100Ω	Frequency ≤ 20kHz
100kΩ	100kΩ - 1.1MΩ	90kΩ -	100Ω	Frequency ≤ 1MHz
10kΩ	10kΩ - 110kΩ	9kΩ -	100Ω	Frequency ≤ 2MHz
1kΩ	1kΩ - 11kΩ	900Ω -	100Ω	-----
100Ω	9Ω - 1.1kΩ	Not limited	100Ω	
10Ω	0.9Ω - 10Ω	- 11Ω	100Ω	
1Ω	90mΩ - 1.0Ω	- 1.1Ω	25Ω	Frequency ≤ 2MHz
100mΩ	9mΩ - 100mΩ	- 110mΩ	25Ω	Frequency ≤ 1MHz

Recommended range:

Recommended operating range for high accuracy measurement. If out of the recommended range extremely, the measured value or data output may vary greatly or be overflow.

Measureable range:

Approximate range in which the measurement is possible. The measurement may be possible even outside the above range depending on the measurement conditions.

Restrictions:

The upper and lower limits of the measurement range are restricted depending on the frequency. If you specify an unavailable range, the device operates with the nearest available range (recommended range, measureable range).

The output impedance may be restricted depending on the frequency, signal level, measurement parameters, and CV/CC. (CV: Constant voltage function, CC: Constant current function)

3.5 Basic Operations

Table 3-2 Measurement range list 2/4 (Rd-min = 100Ω)

Measurement range	Recommended range	Measureable range	Rd	Restrictions
1MΩ	1MΩ - 11MΩ	900kΩ -	100Ω	Frequency ≤ 20kHz
100kΩ	100kΩ - 1.1MΩ	90kΩ -	100Ω	Frequency ≤ 1MHz
10kΩ	10kΩ - 110kΩ	9kΩ -	100Ω	Frequency ≤ 2MHz
1kΩ	1kΩ - 11kΩ	900Ω -	100Ω	-----
100Ω	9Ω - 1.1kΩ	Not limited	100Ω	
10Ω	0.9Ω - 10Ω	- 11Ω	100Ω	
1Ω	Same as above (Measured in the 10Ω range)	Same as above (Measured in the 10Ω range)	100Ω	These ranges are unavailable.
100mΩ				

Table 3-2 Measurement range list 3/4 (Rd-min = 25Ω-100)

Measurement range	Recommended range	Measureable range	Rd	Restrictions
1MΩ	1MΩ - 11MΩ	900kΩ -	100Ω	Frequency ≤ 20kHz
100kΩ	100kΩ - 1.1MΩ	90kΩ -	100Ω	Frequency ≤ 1MHz
10kΩ	10kΩ - 110kΩ	9kΩ -	100Ω	Frequency ≤ 2MHz
1kΩ	1kΩ - 11kΩ	900Ω -	100Ω	-----
100Ω	100Ω - 1.1kΩ	90Ω -	25Ω	*1 Signal level ≤ 1.2V (When CV is enabled, ≤ 1.05V) CC is disabled Secondary parameter ≠ Rdc
10Ω	0.9Ω - 110Ω	Not limited	25Ω	
1Ω	90mΩ - 1.0Ω	- 1.1Ω	25Ω	Frequency ≤ 2MHz
100mΩ	9mΩ - 100mΩ	- 110mΩ	25Ω	Frequency ≤ 1MHz

*1 If the restriction conditions are not met, the operation is the same as when Rd-min = 25Ω-1.

Table 3-2 Measurement range list 4/4 (Rd-min = 6Ω-100-f1k)

Measurement range	Recommended range	Measureable range	Rd	Restrictions
1MΩ	1MΩ - 11MΩ	900kΩ -	100Ω	*2 Frequency ≤ 1kHz
100kΩ	100kΩ - 1.1MΩ	90kΩ -	100Ω	
10kΩ	10kΩ - 110kΩ	9kΩ -	100Ω	Signal level ≤ 1.2V (when CV is enabled, ≤ 1.05V when CC is enabled, ≥ 40mA)
1kΩ	1kΩ - 11kΩ	900Ω -	100Ω	
100Ω	100Ω - 1.1kΩ	90Ω -	6Ω	
10Ω	0.9Ω - 110Ω	Not limited	6Ω	Secondary parameter ≠ Rdc
1Ω	90mΩ - 1.0Ω	- 1.1Ω	6Ω	
100mΩ	9mΩ - 100mΩ	- 110mΩ	6Ω	

*2 If the restriction conditions are not met, the operation is the same as when Rd-min = 25Ω-1.

Table 3-3 Max. current, max. voltage, and output impedance in each measurement range

Measurement range	Maximum current (Detection)	Maximum voltage		Output impedance Rd
		Measurement signal level	Detection	
1M Ω	5 μ Arms	5Vrms	5Vrms	100Ω
100k Ω	50 μ Arms	5Vrms	5Vrms	100Ω
10k Ω	500 μ Arms	5Vrms	5Vrms	100Ω
1k Ω	5mArms	5Vrms	5Vrms	100Ω
100 Ω	50m / 12mArms (Rd= 100 / 25, 6 Ω)	5 / 1.2 Vrms (Rd= 100 / 25, 6 Ω)	5 / 1.2 Vrms (Rd= 100 / 25, 6 Ω)	100 / 25 / 6 Ω
10 Ω	50m / 200mArms (Rd= 100, 25 / 6 Ω)	5 / 1.2 Vrms (Rd= 100 / 25, 6 Ω)	0.5 / 1.2Vrms (Rd= 100 / 25, 6 Ω)	100 / 25 / 6 Ω
1 Ω	200mArms	5 / 1.2 Vrms (Rd= 25 / 6 Ω)	200mVrms	25 / 6 Ω
100m Ω	200mArms	5 / 1.2 Vrms (Rd= 25 / 6 Ω)	20mVrms	25 / 6 Ω

- The output impedances shown in **bold font** indicate the initial values.
- The max sensing current/voltage shown in the above table are values obtained at the largest measurement signal level for each output impedance. If the measurement signal level is decreased, the range of detection current/voltage will be narrower.
- Allowable current peak value (instantaneous value) including DC bias current (leak current) is about 1.4 times the max sensing current (RMS value). Actually, the detection side has a margin of 10% or more.

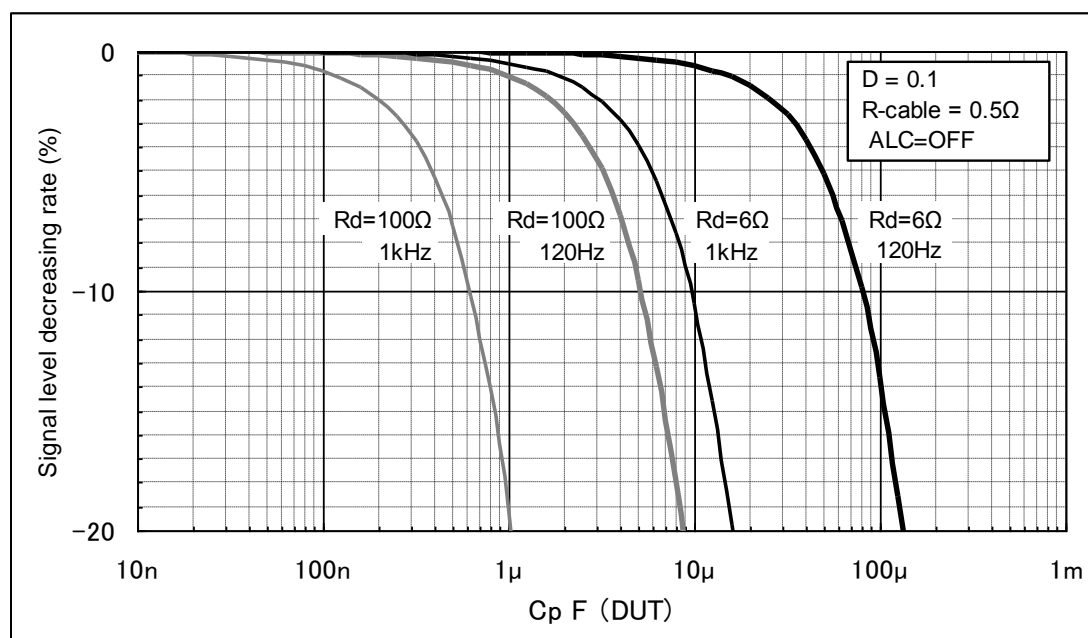

Rd: Output impedance

Sum of cable resistance, contact resistance, and Rd error (+) = 0.5 Ω

Figure 3-5 Capacitance to measurement signal level characteristics

■ Automatic selection or hold of measurement range

AUTO / HOLD

Press the **AUTO/HOLD** key, and the measurement range is switched between automatic selection (AUTO) and hold (HOLD).

When the measurement range is held, it can be selected manually. When holding the measurement range, select a measurement range within the recommended range if possible, considering the variations of DUT.

For the DUT having large variations or strong nonlinearity, automatic selection may fail. Also, in the measurement of large capacitance or inductance, the settling of signal will take time. Several measurements may be required until correct measurement range is set in automatic selection and the measured value becomes stable.

■ Manual selection of measurement range

SHIFT + [**RANGE**]

Press the **SHIFT** + [**RANGE**] keys to display the measurement range setting menu.

Auto / Manual	Current range	Minimum output impedance	
RANGE : Manual	1kΩ	Rd:25Ω-1	Current setting
0)DOWN 1)UP	100mΩ to 1MΩ	2)Rd-min	Options

Selectable operations

Selectable range

Auto	Displayed when the measurement range is automatically selected.
Manual	Displayed when the measurement range is manually selected (hold).
DOWN	Switches the measurement range to a range having lower impedance by zero.
UP	Switches the measurement range to a range having higher impedance by one.
Rd-min	Displays the minimum output impedance setting menu of drive signal source.

The measurement range can be changed with a numeric key, one step at a time. If DOWN or UP is operated, the measurement range is held (manual selection). Note that the measurement range of impedance should be lowered when measuring larger capacitance C or admittance |Y|.

Perform the EXIT operation to return to the measurement screen.

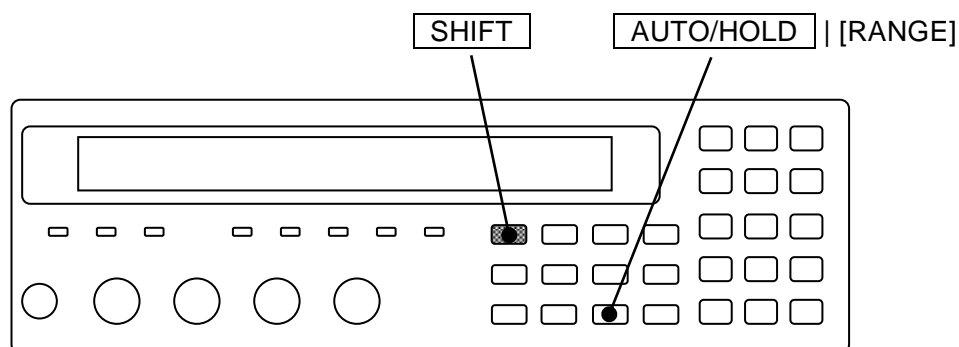

Rd-min: The minimum output impedance setting menu is as follows.

R-drive min: 25Ω-1

0)6Ω-100-f1k 1)25Ω-1 2)25Ω-100 3)100Ω

Current setting

Options

6Ω-100-f1k	For measurement ranges from 100mΩ to 100Ω, this sets the output impedance to 6Ω.
25Ω-1	For measurement ranges from 100mΩ to 1Ω this sets the output impedance to 25Ω (initial value).
25Ω-100	For measurement ranges from 100mΩ to 100Ω, this sets the output impedance to 25Ω.
100Ω	For all measurement ranges, this sets the output impedance to 100Ω.

If a setting is made or the EXIT operation is performed, one-previous menu comes back.

Each option has the following features:

6Ω-100-f1k : Suitable for large capacitance measurement.

- The settling time is short since the CR time constant is small.
- The variation of measured value is small since the measurement current is large.
- The measurement with almost constant voltage is possible since the voltage drop caused by the output impedance is small.
- The distortion of signal voltage can be reduced even when DUT has nonlinear voltage-current characteristics.

25Ω-1 : Suitable for general measurement.

When measuring low impedance, the measurement variation of low impedance can be reduced since the measurement current is large.

25Ω-100 : When measuring a DUT which has nonlinear voltage-current characteristics, the measured value can be in agreement with the value of an impedance measurement instrument which has an equivalent output impedance of 25Ω.

This option allows you, for example, to measure the inductance of up to about 150μH within the recommended range under the conditions of frequency = 1MHz, signal level = 0.5V, and output impedance = 25Ω. When measuring larger inductances, since the impedance of DUT is high. Measured values of the rate depending on the output impedance decreases.

100Ω : Suitable for measurement of inductors with core.

When measuring a DUT which has nonlinear voltage-current characteristics, the measured value can be in agreement with the value of an impedance measurement instrument which has an output impedance of 100Ω. Note that the variation may become large when measuring low impedance (small inductance).

For inductors with core or ceramic capacitors which have nonlinear voltage-current characteristics, the measured value varies depending on the voltage applied to the DUT, the current flowing in the DUT, and the signal distortion (waveform). The signal distortion mainly depends on the output impedance and impedance bridge method of the LCR meter. When the impedance of DUT is low enough or high enough for the output impedance, almost the same measured value can be obtained regardless of the output impedance, by keeping the current flowing in the DUT or the voltage applied to the DUT constant.

⚠ CAUTION

When measuring low impedance, if the output impedance is reduced, the voltage applied to the DUT may increase greatly. When measuring a DUT weak to the reverse voltage or overvoltage, do not exceed the permissible range, for example, by reducing the measurement signal level in advance.

■ When a number of DUTs are measured

It is recommended to hold the measurement range when measuring a number of DUTs having almost same value. If you connect or disconnect DUTs when both the internal trigger and the automatic range selection are set, the measurement range is switched at each connection/disconnection to increase the measurement time.

■ Measurement range of DC (direct-current) resistance

If DC resistance is selected as a secondary parameter, the measurement range of DC resistance is displayed in the measurement range setting menu. The DC resistance measurement range is independent from the AC impedance measurement range, and normally it is automatically selected. In the remote control, it can be held to specific range. To return to automatic selection by the panel operation, initialize it with the initialize menu.

Measurement range of DC (direct-current) resistance

RANGE:	Manual 100kΩ	DC100mΩ	Rd:25Ω-100
---------------	---------------------------------------	----------------------------------	-------------------------------------

3.5.6.4 Trigger

The ZM2376 receive a trigger signal to start the measurement.

With the trigger setting menu, set the trigger source and measurement sequence.

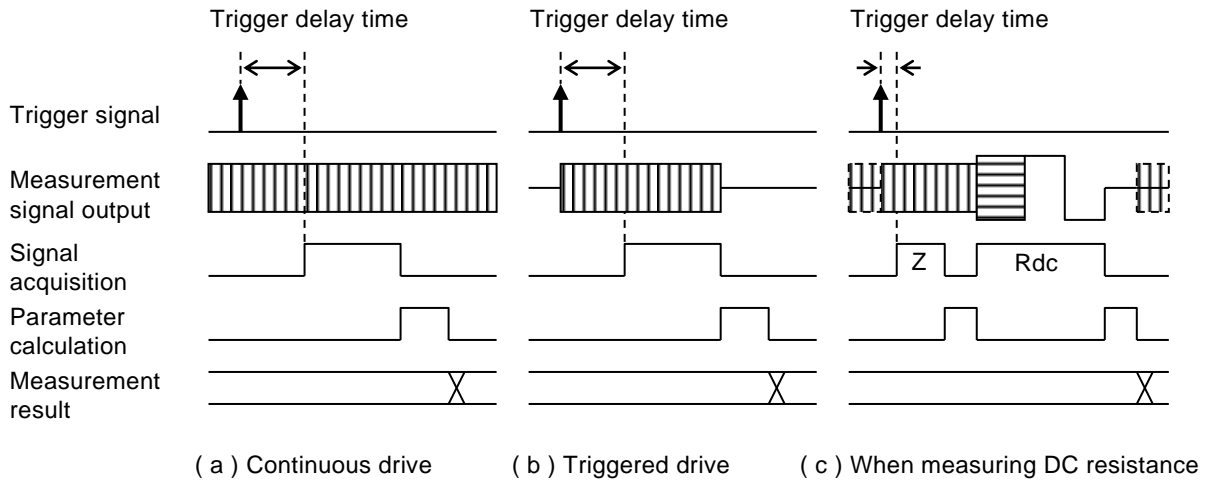

Figure 3-6 Measurement sequence

■ Selection of trigger source

SHIFT + [**TRIG MODE**]

Press the **SHIFT** + [TRIG MODE] keys to display the trigger setting menu.

Trigger source	Trigger delay	Triggered drive	
TRIG SRC:Ext	Delay=100.0000s	SRC Sync=ON	Current setting
0) Int 1) Man 2) Ext 3) Bus 4) Delay 5) S . Sync			Options

- Int Internal trigger. Upon completion of measurement, a trigger is applied automatically and measurement is executed continuously. Other trigger signals are ignored.
 - Man Manual trigger. Press the **TRIG** key on the front panel to apply a trigger signal.
 - Ext External trigger. A trigger is applied with TRIG signal through the handler interface.
 - Bus A trigger is applied by the remote control. Refer to the description of *TRG and GET.
 - Delay Displays the trigger delay setting menu.
 - S.Sync Displays the triggered drive setting menu.
- } Trigger source

Select a trigger source or perform the EXIT operation to return to the measurement screen.

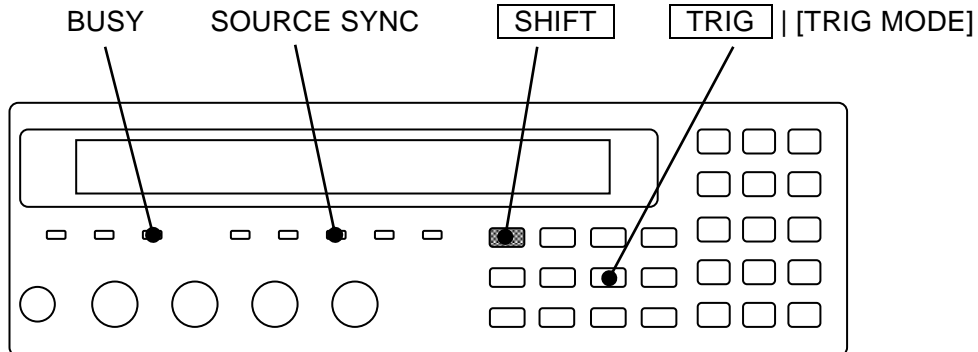

Current trigger source is displayed on the second line of measurement screen (in case of status display).

A100Ω FAST256 **Int** OpShLd1m

TRIG SOURCE

Trigger source: Int / Man / Ext / Bus

■ Applying a trigger (measurement start)

TRIG

When the trigger source is Man (manual) and the measurement has not been executed, if the **TRIG** key is pressed, the measurement starts and it is executed only once. One-time measurement will take long time when the frequency is lower than 1Hz, or the number of averaging count is large. Note that the last measured value is displayed during the measurement.

BUSY lamp

During measurement, the BUSY lamp lights up or blinks.

■ Trigger delay time: Trigger delay setting menu

The trigger delay time is the time from trigger up to signal acquisition start. The signal settling time varies depending on the nature of DUT or required accuracy. For the trigger delay time, set long time to the extent that the measured value does not vary even if the trigger delay time is changed a little.

Press the **SHIFT** + **[TRIG MODE]** keys to display the trigger setting menu, and select Delay with a numeric key and the trigger delay setting menu (see below) will be displayed.

Trigger Delay : 0.4567s 0.0000s to 999.9999s

Current setting

Available value ranges

Input a numeric value to set the trigger delay time.

If a setting is made or the EXIT operation is performed, one-previous menu comes back.

If the measurement frequency > 20kHz, the settlement of the internal bridge by connection/disconnection of DUT will take 10ms at maximum. If the measurement frequency ≤ 20kHz, the settling time of the internal bridge can be ignored.

For high dielectric type capacitors or inductors with a core having hysteresis characteristics, it is recommended to acquire the signal after at least one period of signal elapsed (1ms at 1kHz, or 8ms at 120Hz) since the measurement signal was applied to the DUT. It may take long time for settling if dielectrics absorption of DUT is large.

When the DUT does not have hysteresis or dielectrics absorption, the settling time of signal is determined by the following two factors:

- 1) Time constant determined by the output impedance or maximum drive current of ZM2376 and the capacitance of DUT.
- 2) ZM2376 internal settling time

The ZM2376 output impedance and maximum drive current depend on the measurement range.

For details  “3.5.6.3 Measurement range”

If the DUT is pure capacitance C or inductor L, the signal settles at the time constant $C \times R_d$ or L/R_d where the ZM2376 output impedance is R_d . Make allowance for the settling time of 5 to 7 times the time constant. The settling time will vary if the current is limited.

When the triggered drive is enabled, if the trigger delay time is set to zero, the measurement will be incorrect. If the triggered drive is enabled, it will take time from output of the drive signal to settlement of the signal. Also, the settling time is required when the frequency or signal level is changed.

Approximate settling time in the measurement of large capacitance can be obtained from the measurement frequency, DUT capacitance C (F), and output impedance R_d (Ω).

Measurement frequency 120Hz Settling time = $4\text{ms} + 6 \times R_d \times C$

Measurement frequency 1kHz Settling time = $1\text{ms} + 6 \times R_d \times C$

Setting example of trigger delay time (in both cases, $R_d=100\Omega$)

Measurement frequency 120Hz, DUT 220 μ F Trigger delay time 142ms
(about 17 periods of signal)

Measurement frequency 1kHz, DUT 10 μ F Trigger delay time 7ms

■ Drive only at measurement: Triggered drive setting menu

Use the triggered drive to add the measurement signal to the DUT only during the required period.

Press the **[SHIFT]** + **[TRIG MODE]** keys to display the trigger setting menu, and select S.Sync with a numeric key, and the triggered drive setting menu (see below) will be displayed.

Source Sync:ON 0)OFF 1)ON
--

Current setting
Options

- | | |
|-----|--|
| OFF | Disables triggered drive.
Outputs measurement signal at all times. |
| ON | Enables triggered drive.
Drives the DUT in synchronization with the trigger, until the signal has been acquired from the trigger. Once the measurement is completed, the measurement signal is not output until the next trigger. |

If a setting is made or the EXIT operation is performed, one-previous menu comes back.

SOURCE SYNC lamp

The SOURCE SYNC lamp lights up when the triggered drive is enabled.

The triggered drive has the following advantages.

- Reduction of measurement contact degradation
Since the measurement signal can be output only during the required period after the DUT is connected, the damage to the contact caused by connecting or disconnecting the DUT can be reduced. With the measurement signal output, connecting or disconnecting the low impedance DUT (for example, large capacitance) or inductor may damage the measurement contact.
- Reduction of interference caused by close installation
When two or more instruments are installed closely, if the measurement timing is shifted so that the measurement signals do not overlap, the disturbance from other ZM2376 can be reduced.
- Reduction of variation in short-time measurement
Since the measurement start phase of signal is always the same, the variation of measured value becomes small even when the settling time is insufficient. If you want to just monitor the variation of value and do not need an accurate value, you can shorten the measurement time by understanding the correlation with the correct value. This is particularly useful for DUTs with hysteresis characteristics.

The DC bias is maintained constant regardless of the triggered drive setting.

⚠ CAUTION

When measuring a capacitance with the internal DC bias turned on, charge the DUT to the same voltage as the bias voltage of the LCR meter before connecting the DUT. Otherwise, a large charge-discharging current flows even with triggered drive when the DUT is connected, which may damage the measurement contact.

3.5.6.5 Measurement speed

SPEED

Press the **SPEED** key to display the measurement speed setting menu.

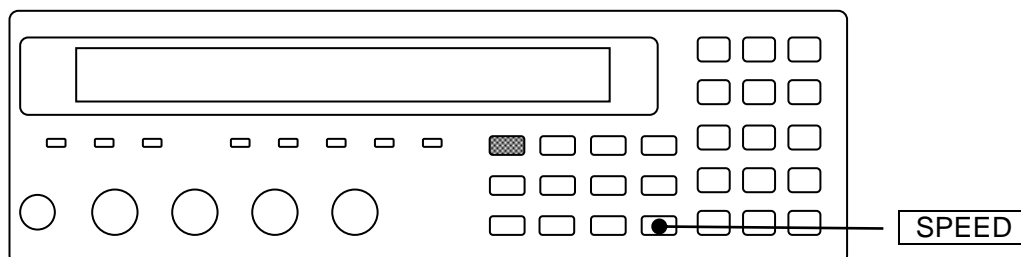

Measuring Speed : FAST
0)RAP 1)FAST 2)MED 3)SLOW 4)VSLO

Current setting
 Available value ranges

If a setting is made or the EXIT operation is performed, one-previous menu comes back.

Current measurement speed is displayed on the second line of measurement screen.

A100Ω **FAST**256 Int OpShLd1m
 SPEED/AVERAGE

Measurement speed: RAPid / FAST / MEDium / SLOW / VerySLOW
 (Lower-case letters are not displayed)

Table 3-4 Example of measurement time (supplementary value)

Measurement frequency	Measurement speed				
	RAP	FAST	MED	SLOW	VSLO
(DC)	150ms	150ms	150ms	218ms	616ms
120Hz	10ms (1 cycle)	10ms (1 cycle)	26ms (3 cycles)	126ms (15 cycles)	501ms (60 cycles)
1kHz	2ms (1 cycle)	5ms (4 cycles)	25ms (24 cycles)	121ms (120 cycles)	501ms (500 cycles)
10kHz	2ms	5ms	25ms	121ms	501ms
100kHz	2ms	5ms	25ms	121ms	501ms
1MHz	2ms	5ms	25ms	121ms	501ms

Conditions: Measurement range hold, Trigger delay time = 0, Averaging count = 1

The measurement time of direct current (DC) is the time added when DC resistance is measured.

The measurement time at each frequencies is the time from input of TRIG signal to output of EOM signal through the handler interface when DC resistance is not measured.

The values in () at 120Hz and 1kHz express the signal acquisition time with the cycles of the signal.

The signal acquisition time is obtained by subtracting the calculation time of about 1ms from the measurement time given in Table 3-4.

After the signal acquisition, the DUT can be replaced.

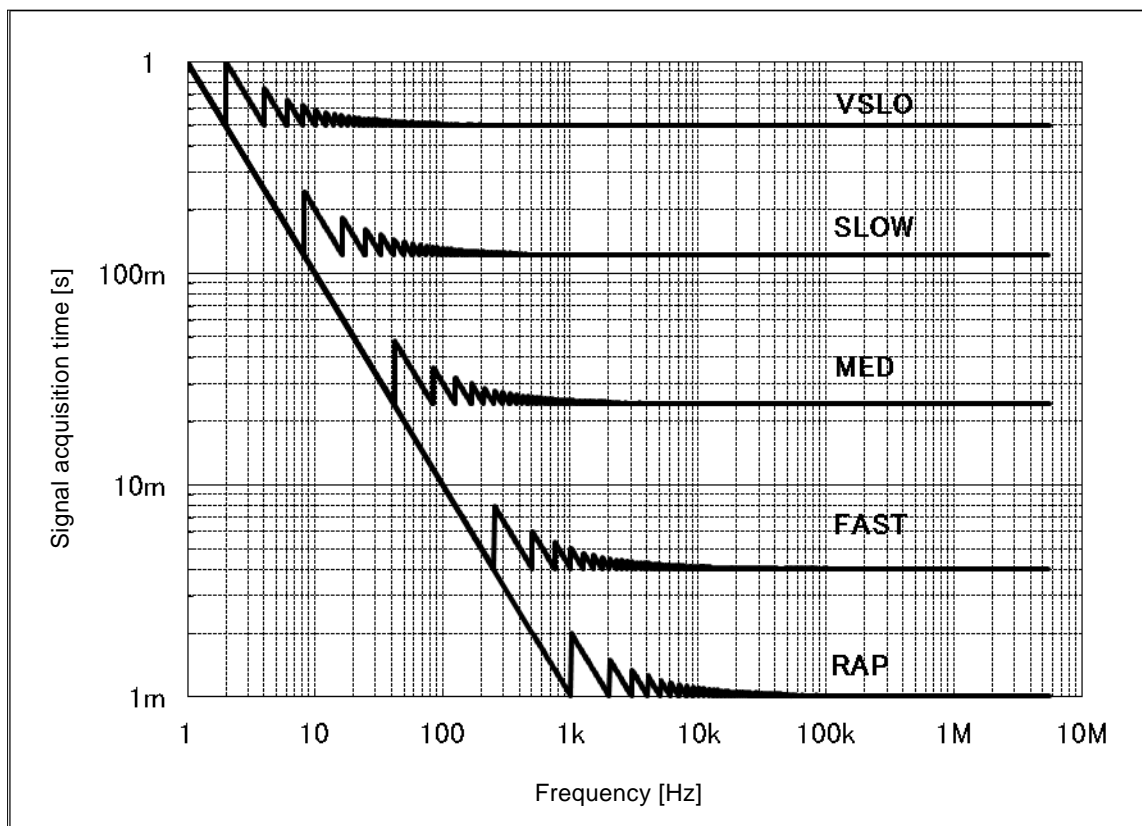

The signal acquisition time at frequency below 1Hz is about one cycle of the signal.

Figure 3-7 Signal acquisition time

■ Measurement time of DC resistance

When DC resistance R_{dc} is selected as a secondary parameter, DC resistance is measured following the measurement of AC impedance. ☞ “Figure 3-6 Measurement sequence” (c) Accordingly, the measurement time is the sum of the following three values:

- Measurement time of AC impedance
- Automatic range selection time of DC resistance (about $75 \text{ ms} \times 1$ to $75 \text{ ms} \times 5$)
The measurement range of DC resistance is automatically selected unless the range is held by remote control.
The adjustment time of measurement range varies depending on the DC resistance.
- Additional time to measure DC resistance ☞ “Table 3-4 Example of measurement time” (DC)

- Measurement time when trigger delay time $\neq 0$
 - Measurement time of AC impedance is extended by the amount of trigger delay time.
 - Automatic range selection time of DC resistance is extended up to about maximum trigger delay time.
 - Measurement time of DC resistance is extended by about $(\text{trigger delay time} - 40\text{ms}) \times 2$ when trigger delay time $> 40\text{ms}$.

3.5.6.6 Correction of Measurement Error

The ZM2376 can correct the following errors that will occur by a measurement fixture or connection cable.

- Zero correction

OPEN correction Corrects the error due to the stray admittance that remains when measurement terminals are opened.

SHORT correction Corrects the error due to the residual impedance that remains when measurement terminals are shorted.

- LOAD correction

Correct the deviation from the true value. This makes sure that measurement of a standard with a known value has no error. The LOAD correction cannot be made individually but executed together with the zero correction.

- Cable length correction

Corrects the additional error due to the connection cable and adjusts the stability of Impedance Bridge.

Setting of current correction is shown on the second line of measurement screen.

A100Ω	FAST256	Int	OpShLd1m
-------	---------	-----	-----------------

CORRECTION

Op OPEN: Indicates the OPEN correction is enabled. (Blank when disabled)

Sh SHORT: Indicates the SHORT correction is enabled. (Blank when disabled)

Ld LOAD: Indicates the LOAD correction is enabled. (Blank when disabled)

1m 0m / 1m / 2m / 4m: Indicates a setting of cable length correction.

■ Relationship between OPEN / SHORT / LOAD correction and frequency

The OPEN / SHORT / LOAD correction can be executed either in the specified frequency range or with one specific frequency. Detailed settings can be set in each correction setting menu.

• When measuring the correction value

GLOBAL correction The correction value is measured between the specified lower and upper limit values.

SPOT correction The correction value is measured only at the current measurement frequency.

The correction value for DC is always measured in both types of measurement.

For the LOAD standard value, there are also two types of measurement, global and spot.

• When measuring DUT

GLOBAL correction Only the global correction value is used, and not the spot correction value.

SPOT correction If the measurement frequency is equal to the spot correction frequency, the spot correction value is used. Otherwise, the global correction value is used.

■ Direct correction frequencies

In the global correction, the correction value is measured directly at the following frequencies (direct correction points):

DC / 0.02 / 0.03 / 0.05 / 0.07 /
0.1 / 0.15 / 0.22 / 0.33 / 0.5 / 0.7 /
1 / 1.5 / 2.2 / 3.3 / 5 / 7 /
10 / 15 / 20 / 30 / 40 / 55 / 70 / 90 /
110 / 130 / 165 / 220 / 290 / 400 / 500 / 600 / 800 /
1k / 1.2k / 1.5k / 2k / 2.5k / 3k / 4k / 5k / 6k / 8k /
10k / 12k / 15k / 20k / 25k / 30k / 40k / 50k / 60k / 80k /
100k / 120k / 150k / 200k / 250k / 300k / 400k / 500k / 600k / 800k /
1M / 1.2M / 1.5M / 2M / 2.5M / 3M / 4M / 5M / 5.5M [Hz]

The correction value is measured at the direct correction frequencies required to execute the correction in the range between the specified lower and upper limit frequencies.

For other frequencies, correction values are obtained by interpolation. At a point near resonance point where the correction value varies largely depending on the frequency, an error by interpolation becomes large, and therefore it is recommended to use the spot correction.

■ Measurement signal level when measuring correction values

The OPEN, SHORT or LOAD correction value is measured on the measurement signal level at that time. Since correction values may vary depending on the measurement signal level, it is recommended to measure correction values again when the measurement signal level is changed. If the measured value after the correction varies at each time of measurement of correction value, it may mean the variation of correction value. In such a case, measure the correction value on a little larger measurement signal level. If you execute the correction only at a specific frequency, more accurate correction is possible by setting the spot correction value with the following steps.

- Disable the OPEN / SHORT / LOAD correction.
- Reduce the measurement speed and set a large averaging count to restrict the variation.
- Measure the spot correction values.
- Set the spot correction values.

■ DC bias when measuring the correction value

Regardless of the DC bias setting, during the measurement of the OPEN or SHORT correction value, the DC bias is automatically turned off only during that measurement. With the DC bias turned on, the OPEN and SHORT correction values cannot be measured.

3.5.6.7 OPEN Correction

Executing the OPEN correction can make the admittance zero when the measurement terminals are opened.

The OPEN correction value can be measured by opening the measurement terminals, or can be set with numeric values.

With the measurement terminals open, press the **SHIFT** + **[OPEN]** keys to display the OPEN correction menu, and select Measure, so that the admittance when the measurement terminals are opened can be corrected to zero.

To set the spot OPEN correction value at the current measurement frequency with a numeric value, set the correction value in the spot OPEN correction menu and finally select ON.

The operation of OPEN correction is executed with the OPEN correction menu.

SHIFT + **[OPEN]**

Press the **SHIFT** + **[OPEN]** keys to display the OPEN correction menu.

<u>OFF ON</u>	<u>Lower limit - Upper limit</u>	(or SPOT)
OPEN Correction:OFF	100Hz - 1.0MHz	Current setting
0)OFF 1)ON 2)Measure	3)SPOT >NEXT	Options (first page)
4)LowFREQ 5)UppFREQ	<PREV	Options (second page)

- OFF** Disables the OPEN correction and returns to the measurement screen.
OPEN correction value is held internally.
- ON** Enables the OPEN correction and returns to the measurement screen.
- Measure** Measures the OPEN correction values.
Upon completion, enables the OPEN correction and returns to the measurement screen.
- SPOT** Displays the spot OPEN correction menu.
When the spot correction is enabled, the correction value is measured with only the current frequency.
- LowFREQ** Displays the lower limit frequency setting menu for the global correction.
This can prohibit the correction with unused low frequencies.
- UppFREQ** Displays the upper limit frequency setting menu for the global correction.
This can prohibit the correction with unused high frequencies.

Perform the EXIT operation to return to the measurement screen.

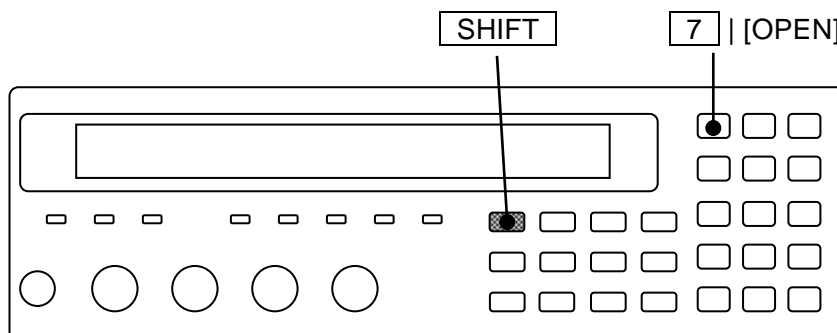

■ Measurement of OPEN correction values

First, place the measurement terminals in open state.

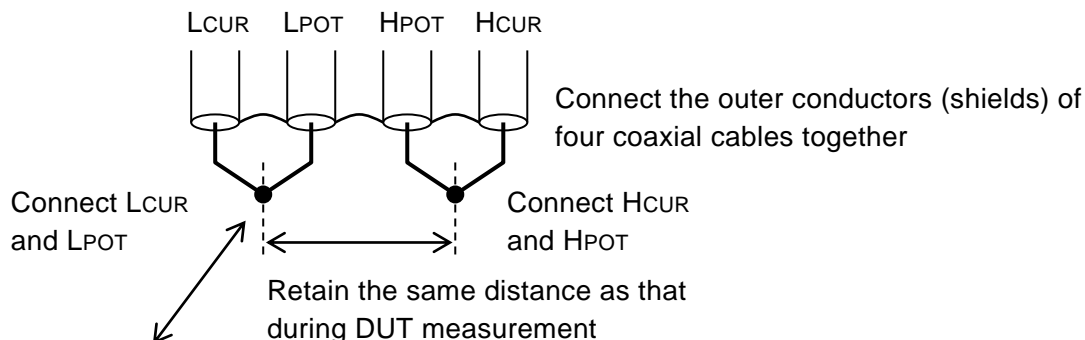

Retain positional relation to ambient dielectrics and conductors same as that during DUT measurement

Figure 3-8 Terminal processing at OPEN correction

To measure the OPEN correction values, press the **[SHIFT]** + **[OPEN]** keys to display the OPEN correction menu, and select Measure with a numeric key. With the initial setting, it will take about 40s to measure the correction values.

During the measurement of OPEN correction values, the following message is displayed.

```
OPEN Measurement (>1kΩ)
Running 9)ABORT
```

The measurement of OPEN correction value can be aborted by pressing the **[9]** key. The above message is also used as the correction value measurement abort menu.

Upon completion of OPEN correction value measurement, the OPEN correction is enabled, and the following completion message is displayed for a short time, and then the measurement screen comes back.

```
Completed Correction ON
```

However, when measured value $\leq 1\text{k}\Omega$, the following warning message is displayed.

```
Warning: Out of range
```

Same warning message is also displayed when the measurement failed by any reason. Even if this warning message is displayed, the ZM2376 use the obtained measured values as OPEN correction values. However, the previous OPEN correction values are held for the frequencies at which the measurement failed.

This warning will disappear when any key is operated or after several seconds have passed.

Perform the EXIT operation to return to one-previous menu.

When you execute both of the OPEN and SHORT corrections, or when you execute the LOAD correction, any of OPEN, SHORT, or LOAD correction is not executed and the measured value becomes CORR Err unless the following condition is met.

Condition for correction : OPEN correction value ($|Z|$) > SHORT correction value ($|Z|$) \times 2

When the OPEN and SHORT correction values are close, the error will increase unless the LOAD correction is executed. If the ratio is 1000 times or less, it is recommended to execute the LOAD correction.

■ Setting of correction lower and upper limit frequencies

(Common to OPEN / SHORT / LOAD correction)

For the global correction, you can set the lower and upper limit frequencies for correction.

The initial values are 40Hz for the correction lower limit frequency and 2MHz for the correction upper limit frequency.

If the correction is not executed for the unused frequency, the measurement time of correction value can be shortened.

The lower and upper limit frequencies set for the global correction are common to the OPEN, SHORT, and LOAD corrections. The following describes the operation procedure in the OPEN correction menu, and the same procedure can be used for the SHORT and LOAD corrections.

SHIFT + **[OPEN]** >> OPEN correction menu

For the global correction, the lower and upper limit frequencies are displayed.

OFF ON	Correction frequency range	
OPEN Correction:OFF	100Hz - 1.0MHz	Current setting
4) LowFREQ 5) UppFREQ	<PREV	Options (second page)

LowFREQ >> Correction lower limit frequency setting menu

Lower Frequency = 100Hz	Current setting
1mHz to 100kHz Upper >= Lower*2	Available ranges

Set the lowest measurement frequency to be used.

The lower and upper limit frequencies can be set with two significant digits.

If the upper limit < the lower limit × 2, the upper limit is automatically set to the lower limit × 2.

If a setting is made or the EXIT operation is performed, one-previous menu comes back.

UppFREQ >> Correction upper limit frequency setting menu

Upper Frequency = 1.0MHz	Current setting
2kHz to 5.5MHz Lower <= Upper/2	Available ranges

Set the highest measurement frequency to be used.

If the lower limit > the upper limit / 2, the lower limit is automatically set to the upper limit / 2 (truncated).

In the global correction, the correction value is measured at the direct correction points required to execute the correction in the range between the specified lower and upper limit frequencies. At other direct correction points, the correction value is retained without being updated. If the frequency range is extended, measure the correction value again. Otherwise, the interpolated correction value may be incorrect.

■ Setting spot OPEN correction

To execute the correction with only the current frequency, enable the spot correction.

In the spot correction, compared to the global correction, the measurement time of correction value is shorter, and no interpolation error occurs. The correction of only DC resistance is not supported.

The spot OPEN correction is set as follows.

SHIFT + [OPEN] >> OPEN correction menu

When the spot correction is enabled, "SPOT" is displayed.

Correction frequency range

OPEN Correction:OFF	SPOT	Current setting
0) OFF 1) ON 2) Measure 3) SPOT	>NEXT	Options

SPOT >> Spot OPEN correction menu

SPOT Correction:OFF	Format:Cp-G	@OPEN	Current setting
0) OFF 1) ON 2) Format 3) Entry			Options

OFF Disables the spot correction.

At the correction value measurement, global correction values are measured.

At the DUT measurement, the global correction value is used.

ON Enables the spot correction.

At the correction value measurement, the spot correction value at the current measurement frequency is measured.

At the DUT measurement, the spot OPEN correction value is used only when the measurement frequency is same as the spot OPEN correction frequency. Otherwise the global correction value is used.

Format Displays the format setting menu for spot OPEN correction value.

Entry Displays the spot OPEN correction value input menu.

If a setting is made or the EXIT operation is performed, one-previous menu comes back.

Whether the spot correction is enabled or disabled is common to the OPEN, SHORT, and LOAD corrections. It can also be set in the spot SHORT correction menu.

If the measurement frequency is changed when the spot correction is enabled, the OPEN, SHORT, and LOAD corrections are all disabled automatically. When you want to execute the spot correction with a new frequency, measure the correction value again.

The spot correction is disabled when recalling either the settings or the correction value.

The spot correction will not be disabled in the following cases.

- When both the setting and the correction value are recalled (Press **SHIFT** + [RECALL] and select **Both**).
- When the frequency is changed during the multi-correction.

■ Setting numeric values/reading of spot OPEN correction value

You can set the spot OPEN correction value at the current measurement frequency with a numeric value or can read the value to fine tune it.

In the spot OPEN correction menu, first specify the format and then set the value.

SHIFT + **[OPEN]**, **[3]** key operations >> Spot OPEN correction menu

SPOT Correction: OFF Format: Cp-G @OPEN
0) OFF 1) ON 2) Format 3) Entry

Format >> Format setting menu for spot OPEN correction value

Format:Cp-G @OPEN
0)G-B 1)Cp-G

Current setting
Options

G Stray conductance (unit: S)
 B Stray susceptance (unit: S)
 Cp Stray capacitance
 (parallel equivalent circuit, unit: F)

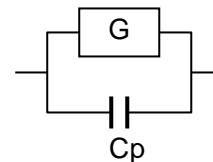
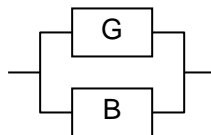

If a setting is made or the EXIT operation is performed, one-previous menu comes back.

Entry >> Spot OPEN correction value input menu

Example:Correction value for the Cp-G format

Co-OPEN=Cp: +123.456pF G:+1.23456μS
±(0.0000p to 999999M) Z>1kΩ 1.00000kHz

Current value
Available ranges

Spot OPEN correction frequency

Frequency when the correction value is measured or set, If disabled, "---"

Set the measured value in the open state measured with all of the OPEN, SHORT, and LOAD corrections disabled. Initially, the cursor exists on the previous value. When the previous value is input and entered with the **[ENTR]** key, the cursor moves to the next value, indicating that the next value can be input. The cursor can be moved between previous and next values by pressing the **[BS]** | **[PREV]** or **[EXP]** | **[NEXT]** key. If either one of the values is set, the measurement frequency at that time is recorded as the spot OPEN correction frequency.

Perform the EXIT operation to return to one-previous menu.

If the spot OPEN correction value is set, the OPEN correction is disabled. To use the set correction value, enable both the spot correction and the OPEN correction.

Though the warning message will be displayed for the input of correction value of impedance $\leq 1\text{k}\Omega$, it is set as it is as the spot OPEN correction value.

If the spot OPEN correction value is zero, the measured value remains as it was before the correction even when the correction is executed.

3.5.6.8 SHORT Correction

Executing the SHORT correction can make the impedance zero when the measurement terminals are shorted.

The SHORT correction values can be measured by shorting the measurement terminals, or can be set with numeric values.

With the measurement terminals short, press the **SHIFT** + **[SHORT]** keys to display the SHORT correction menu, and select Measure, so that the impedance when the measurement terminals are shorted can be corrected to zero.

To set the spot SHORT correction value at the current measurement frequency with a numeric value, set the correction value in the spot SHORT correction menu and finally select ON.

The operation of SHORT correction is executed with the SHORT correction menu.

SHIFT + **[SHORT]**

Press the **SHIFT** + **[SHORT]** keys to display the SHORT correction menu.

OFF ON	Lower limit - Upper limit or SPOT	
SHORT Correction: OFF	100Hz - 1.0MHz	Current setting
0) OFF 1) ON 2) Measure 3) SPOT	>NEXT	Options (first page)
4) LowFREQ 5) UppFREQ	<PREV	Options (second page)

- OFF** Disables the SHORT correction and returns to the measurement screen. SHORT correction value is held internally.
- ON** Enables the SHORT correction and returns to the measurement screen.
- Measure** Measures the SHORT correction value.
Upon completion, enables the SHORT correction and returns to the measurement screen.
- SPOT** Displays the spot SHORT correction menu.
- LowFREQ** Displays the lower limit frequency setting menu for the global correction.
- UppFREQ** Displays the upper limit frequency setting menu for the global correction.

Perform the EXIT operation to return to the measurement screen.

The lower and upper limit frequencies set for the global correction are common to the OPEN, SHORT, and LOAD corrections.

Lower limit frequency setting menu }
Upper limit frequency setting menu } ← “3.5.6.7 OPEN Correction”

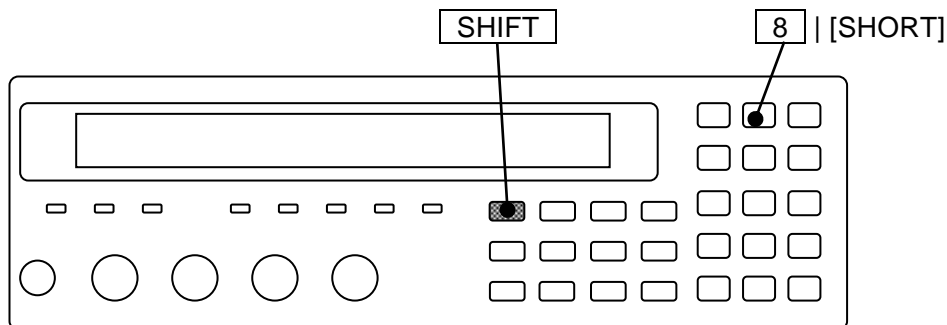

■ Measurement of SHORT correction value

First, short the measurement terminals.

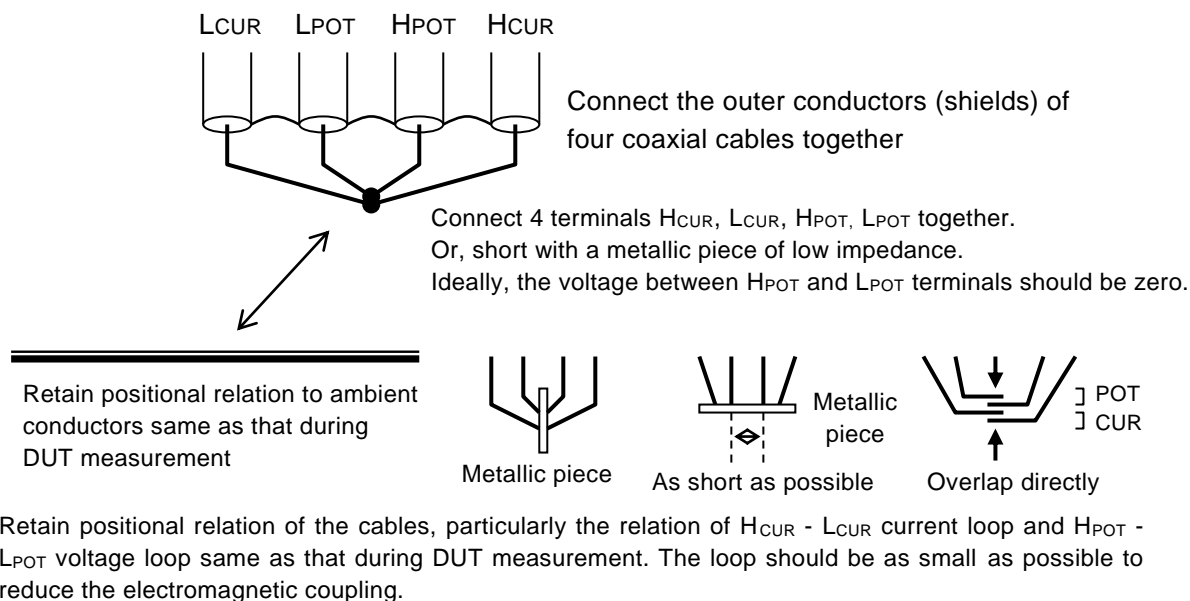

Figure 3-9 Terminal processing at SHORT correction

To measure the SHORT correction value, press the **SHIFT** + **[SHORT]** keys to display the SHORT correction menu, and select Measure with a numeric key.

During the measurement of SHORT correction value, the following message is displayed.

```
SHORT Measurement (<900Ω)
Running          9)ABORT
```

The measurement of SHORT correction value can be aborted by pressing the **9** key.

Upon completion of SHORT correction value measurement, the SHORT correction is enabled, and the following completion message is displayed for a short time, and then the measurement screen comes back.

```
Completed Correction ON
```

However, when measured value $\geq 900\Omega$, the following warning message is displayed.

```
Warning: Out of range
```

Same warning message is also displayed when the measurement failed by any reason. Even if this warning message is displayed, the ZM2376 use the obtained measured values as SHORT correction values. However, the previous SHORT correction values are held for the frequencies at which the measurement failed.

This warning will disappear when any key is operated or after several seconds have passed.

Perform the EXIT operation to return to one-previous menu.

■ Setting spot SHORT correction

To execute the correction with only the current frequency, enable the spot correction.

The spot SHORT correction is set as follows.

SHIFT + **[SHORT]** >> SHORT correction menu

When the spot correction is enabled, "SPOT" is displayed.

Correction frequency range

SHORT Correction: OFF	SPOT	Current setting
0) OFF 1) ON 2) Measure 3) SPOT	>NEXT	Options

SPOT >> Spot SHORT correction menu

SPOT Correction: OFF	Format: Ls-Rs	@SHORT	Current setting
0) OFF 1) ON 2) Format 3) Entry			Options

OFF Disables the spot correction.

At the correction value measurement, global correction values are measured.

At the DUT measurement, the global correction value is used.

ON Enables the spot correction.

At the correction value measurement, the spot correction value at the current measurement frequency is measured.

At the DUT measurement, the spot SHORT correction value is used only when the measurement frequency is same as the spot SHORT correction frequency.

Otherwise the global correction value is used.

Format Displays the format setting menu for spot SHORT correction value.

Entry Displays the spot SHORT correction value input menu.

If a setting is made or the EXIT operation is performed, one-previous menu comes back.

Whether the spot correction is enabled or disabled is common to the OPEN, SHORT, and LOAD corrections. It can also be set in the spot OPEN correction menu.

If the measurement frequency is changed when the spot correction is enabled, the OPEN, SHORT, and LOAD corrections are all disabled automatically. When you want to execute the spot correction with a new frequency, measure the correction value again.

■ Setting numeric values/reading of spot SHORT correction value

You can set the spot SHORT correction value at the current measurement frequency with a numeric value or can read the value to fine tune it.

In the spot SHORT correction menu, first specify the format and then set the value.

SHIFT + **[SHORT]**, **[3]** key operations >> Spot SHORT correction menu

SPOT Correction: OFF	Format:Ls-Rs	@SHORT
0) OFF	1) ON	2) Format
		3) Entry

Format >> Format setting menu for spot SHORT correction value

Format: Ls-Rs	@SHORT
0) Rs-X	1) Ls-Rs

Current setting

Options

Rs Residual resistance (unit: Ω)

X Residual reactance (unit: Ω)

Ls Residual inductance (unit: H)

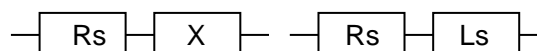

If a setting is made or the EXIT operation is performed, one-previous menu comes back.

Entry >> Spot SHORT correction value input menu

Example: Correction value for the Rs-X format

Co-SHORT=Rs: +123.456mΩ	X : +123.456mΩ
±(0.0000p to 999999M)	Z<900Ω
	1.00000kHz

Current value

Available ranges

Spot SHORT correction frequency

Frequency when the correction value is measured or set

If disabled, "---"

Set the measured value in the short state measured with all of the OPEN, SHORT, and LOAD corrections disabled. Initially, the cursor exists on the previous value. When the previous value is input and entered with the **ENTR** key, the cursor moves to the next value, indicating that the next value can be input. The cursor can be moved between previous and next values by pressing the **BS** | **[PREV]** or **EXP** | **[NEXT]** key. If either one of the values is set, the measurement frequency at that time is recorded as the spot SHORT correction frequency.

Perform the EXIT operation to return to one-previous menu.

If the spot SHORT correction value is set, the SHORT correction is disabled. To use the set correction value, enable both the spot correction and the SHORT correction.

Though the warning message will be displayed for the input of correction value of impedance $\geq 900\Omega$, it is set as it is as the spot SHORT correction value.

If the spot SHORT correction value is zero, the measured value remains as it was before the correction even when the correction is executed.

3.5.6.9 LOAD Correction

The LOAD correction corrects the measurement error caused by the connection circuit network between the measurement terminals and DUT, based on a standard with a known value. To execute more accurate correction, use a standard with an impedance as close to that of DUT as possible. The LOAD correction is always executed together with the OPEN and SHORT corrections. Assuming that the circuit is a linear 2-terminal-pair circuit network, the error caused by the connection circuit network can be removed by executing the OPEN, SHORT, and LOAD corrections. The LOAD correction also has the effect of reducing a small error which occurs under certain conditions of frequency, signal level, measurement range, and so on. However, if the expected model differs from the actual model, the error may be rather increased. The OPEN correction value, the SHORT correction value, and the LOAD correction value can be measured as often as needed in an arbitrary order. It is also possible to change the LOAD standard value later.

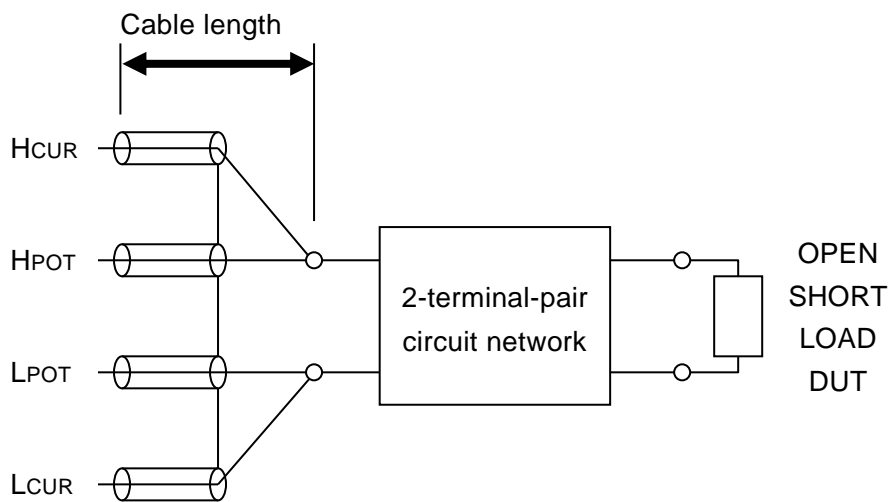

Figure 3-10 Connection circuit network for LOAD correction

Typical LOAD correction procedures are described below.

■ Spot LOAD correction procedure 1 (When the value of the standard is known)

If you only need to execute the correction at a specific frequency and the correct value of the standard at that frequency is known in advance, perform the following steps to execute the LOAD correction.

- Enables the spot correction.
- Disables the OPEN correction and the SHORT correction.
- Set the exact value of the standard as the LOAD standard value.
 - ☞ **SHIFT** + [LOAD] >> SPOT >> Format setting, STD setting
 - >> EXIT operation
- Connect the standard at the end of the actual connection circuit network and measure the LOAD correction value.
 - ☞ **Measure**
- The LOAD correction is automatically enabled.
- Execute the OPEN correction and the SHORT correction at the end of the actual connection circuit network.

■ Spot LOAD correction procedure 2 (When the value of the standard is unknown)

If you only need to execute the correction at a specific frequency but the correct value of the standard cannot be obtained, perform the following steps to execute the LOAD correction.

- Enables the spot correction.
- Disables the LOAD correction.
- Execute the OPEN correction and the SHORT correction with a smallest additional error, and then measure the LOAD standard value with the standard.
 - ☞ **SHIFT** + [LOAD] >> STD-Meas

For example, directly connect the standard to the measurement terminals and execute the measurement. You may use a direct-coupled type test fixture (4-terminal connection type) attached to a part with stable characteristics as the standard.
- Disables the OPEN correction and the SHORT correction.
- Connect the standard at the end of the actual connection circuit network and measure the LOAD correction value.
 - ☞ **Measure**
- The LOAD correction is automatically enabled.
- Execute the OPEN correction and the SHORT correction again at the end of the actual connection circuit network.

If the correction is performed correctly, almost the same value is obtained as the direct connection even when the measurement is executed at the end of the connection circuit network.

■ Global LOAD correction procedure (When the value of the standard is not known)

To execute the correction in the range between the specified lower and upper limit frequencies, perform the following steps to execute the LOAD correction.

- Disables the spot correction. Also, disables the LOAD correction.
- Execute the OPEN correction and the SHORT correction with a smallest additional error, and then measure the LOAD standard value with the standard.
- Disables the OPEN correction and the SHORT correction.
- Connect the standard at the end of the actual connection circuit network and measure the LOAD correction value.
- The LOAD correction is automatically enabled.
- Execute the OPEN correction and the SHORT correction again at the end of the actual connection circuit network.

■ LOAD correction menu

The operation of LOAD correction is executed with the LOAD correction menu.

SHIFT + [**LOAD**]

Press the **SHIFT** + [**LOAD**] keys to display the LOAD correction menu.

OFF ON	Lower limit - Upper limit or SPOT	
LOAD Correction: OFF 100Hz - 1.0MHz		Current setting
0) OFF 1) ON 2) Measure 3) SPOT >NEXT		Options (first page)
4) LowFREQ 5) UppFREQ 6) STD-Meas <PREV		Options (second page)

- OFF** Disables the LOAD correction and returns to the measurement screen.
LOAD correction value is held internally.
- ON** Enables the LOAD correction and returns to the measurement screen.
The OPEN correction and SHORT correction are also enabled.
- Measure** Measures the LOAD correction value.
Before measurement, connect the standard with a known value at the end of the actual connection circuit network.
- SPOT** Displays the spot LOAD correction menu.
- LowFREQ** Displays the lower limit frequency setting menu for the global correction.
- UppFREQ** Displays the upper limit frequency setting menu for the global correction.
- STD-Meas** Measures the LOAD standard value.
Before measurement, connect the standard under high measurement accuracy conditions.

If a setting is made or the EXIT operation is performed, the measurement screen comes back.

The lower and upper limit frequencies set for the global correction are common to the OPEN, SHORT, and LOAD corrections.

Lower limit frequency setting menu }
Upper limit frequency setting menu } ☞ “3.5.6.7 OPEN Correction”

The LOAD correction of DC resistance R_{dc} is not supported.

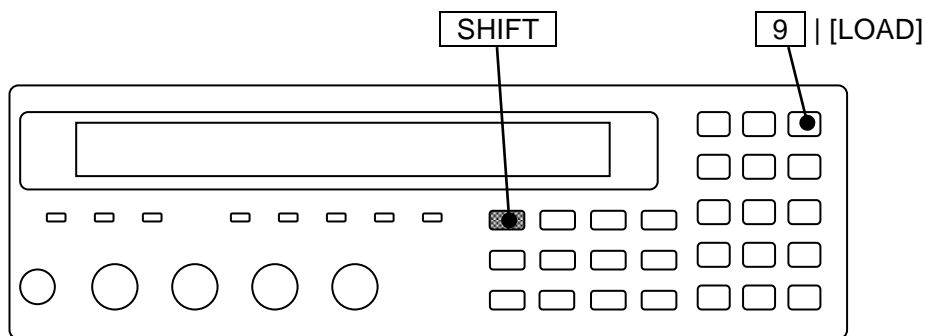

■ Setting spot LOAD correction

To execute the correction with only the current frequency, enable the spot correction.

The spot LOAD correction is set as follows.

SHIFT + **[LOAD]** >> LOAD correction menu

When the spot correction is enabled, "SPOT" is displayed.

Correction frequency range

LOAD Correction: OFF	SPOT	Current setting
0) OFF 1) ON 2) Measure 3) SPOT	>NEXT	Options

SPOT >> Spot LOAD correction menu

SPOT Correction: OFF	Format: Cp-D	@LOAD	Current setting
0) OFF 1) ON 2) Format 3) STD 4) Entry			Options

OFF Disables the spot correction.

At the correction value measurement, global correction values are measured.

At the standard value measurement, global standard values are measured.

At the DUT measurement, the global correction value and the global standard value are used.

ON Enables the spot correction.

At the correction value measurement, the spot correction value at the current measurement frequency is measured.

At the standard value measurement, the spot standard value at the current measurement frequency is measured.

At the DUT measurement, the spot correction value and the spot standard value are used only when the measurement frequency is same as the spot LOAD correction frequency. Otherwise the global correction value and the global standard value are used.

Format Displays the format setting menu for LOAD correction.

STD Displays the spot LOAD standard value input menu.

Entry Displays the spot LOAD correction value input menu.

If a setting is made or the EXIT operation is performed, one-previous menu comes back.

Whether the spot correction is enabled or disabled is common to the OPEN, SHORT, and LOAD corrections.

If the measurement frequency is changed when the spot correction is enabled, the OPEN, SHORT, and LOAD corrections are all disabled automatically. When you want to execute the spot correction with a new frequency, measure the correction value again. When recalling from the setting memory, the OPEN, SHORT, and LOAD corrections are not disabled even if the frequency is changed due to the operation, and the saved settings are restored. Even if the frequency is automatically changed by

the multi-measurement, the OPEN, SHORT, and LOAD corrections are not disabled, and the previous setting of enable/disable is held.

Format >> Format setting menu for LOAD correction

LOAD Standard format: Cp-D	Current setting
0) Cp-D 1) Cs-D 2) Rp-Cp 3) Rs-Ls >NEXT	Options (first page)
4) Rs-X 5) Z-θ <PREV	Options (second page)

Select the format to use when setting the spot LOAD correction value or the spot LOAD standard value with numeric values or displaying them.

If a setting is made or the EXIT operation is performed, one-previous menu comes back.

STD >> Spot LOAD standard value input menu

Example: Standard value for the Cp-D format

LOAD STD= Cp: +1.23456μF D: +234.56m	Current value
±(0.0000p to 999999M) 1.00000kHz	Available ranges

Spot LOAD correction frequency

Frequency when the correction or standard value is set or measured

If disabled, "---"

Enter the calibration value (exact value) of the standard.

Initially, the cursor exists on the previous value. When the previous value is input and entered with the **ENTR** key, the cursor moves to the next value, indicating that the next value can be input.

The cursor can be moved between previous and next values by pressing the **BS** | **[PREV]** or

EXP | **[NEXT]** key.

If a setting is made or the EXIT operation is performed, one-previous menu comes back.

Entry >> Spot LOAD correction value input menu

Correction value for the Cp-D format (example)

Co-LOAD=Cp: +1.02345μF	D: +123.456m	Current value
$\pm(0.0001p$ to 999999M)	1.00000kHz	Available ranges

Spot LOAD correction frequency

Set the value of the standard measured with all of the OPEN, SHORT, and LOAD corrections disabled. Initially, the cursor exists on the previous value. When the previous value is input and entered with the **ENTR** key, the cursor moves to the next value, indicating that the next value can be input. The cursor can be moved between previous and next values by pressing the **BS** | **[PREV]** or **EXP** | **[NEXT]** key. If you specify an extreme value which ZM2376 cannot calculate, an error occurs, and it cannot be set.

Perform the EXIT operation to return to one-previous menu.

If the spot LOAD correction value is set, the LOAD correction is disabled. To use the set correction value, enable both the spot correction and the LOAD correction.

■ Setting LOAD standard value with numeric values (Spot correction)

To use a known calibration value of a standard for the spot LOAD correction, specify the format and then set the standard value in the spot LOAD correction menu.

SHIFT + **[LOAD]** >> LOAD correction menu

LOAD Correction: OFF	100Hz - 1.0MHz
0) OFF 1) ON 2) Measure 3) SPOT	>NEXT

SPOT >> Spot LOAD correction menu

SPOT Correction: OFF	Format: Cp-D	@LOAD
0) OFF 1) ON 2) Format 3) STD 4) Entry		

Format >> Format setting menu for LOAD correction

LOAD Standard format: Cp-D
0) Cp-D 1) Cs-D 2) Rp-Cp 3) Rs-Ls >NEXT

STD >> Spot LOAD standard value input menu

LOAD STD= Cp: +1.23456μF	D: +234.56m
$\pm(0.0000p$ to 999999M)	1.00000kHz

■ Setting numeric values/Reading of LOAD correction value (Spot correction)

To use the pre-measured value of a standard as the spot LOAD correction value, specify the format and then set the correction value in the spot LOAD correction menu.

It is also possible to read the correction value to fine tune it.

SHIFT + **[LOAD]** >> LOAD correction menu

LOAD Correction: OFF	100Hz - 1.0MHz
0) OFF 1) ON 2) Measure 3) SPOT	>NEXT

SPOT >> Spot LOAD correction menu

SPOT Correction: OFF	Format: Cp-D	@LOAD
0) OFF 1) ON 2) Format 3) STD 4) Entry		

Format >> Format setting menu for LOAD correction

LOAD Standard format: Cp-D
0) Cp-D 1) Cs-D 2) Rp-Cp 3) Rs-Ls >NEXT

Entry >> Spot LOAD correction value input menu

CO-LOAD= Cp: +1.02345μF	D: +123.456m
$\pm(0.0001p$ to 999999M)	1.00000kHz

If the entered value differs by 20% or more from the standard value, the warning message is displayed as in the case of measuring the correction value.

■ Measuring LOAD standard value

The LOAD standard value can be measured similarly to the normal DUT measurement.

- Setting of measurement conditions

As a reference value is measured, the measurement accuracy should be as high as possible, and the measurement variation should be small. Set the measurement signal level to 1V and the measurement speed to SLOW or VSLO. Also, the measurement range, output impedance, trigger delay time, and others need to be set properly.

- Preparations for connecting the standard

Remove the connection circuit network between ZM2376 for the LOAD correction and DUT so as to connect the standard and ZM2376 directly with a cable length of 0m. An additional error should be much smaller than that of the connection circuit network for correction.

- Disables OPEN correction and SHORT correction.

- Connection of standard for LOAD correction.

Use a 4-terminal connection as much as possible. Otherwise, use a test fixture of 2-terminal connection in an impedance range where the contact resistance has less impact.

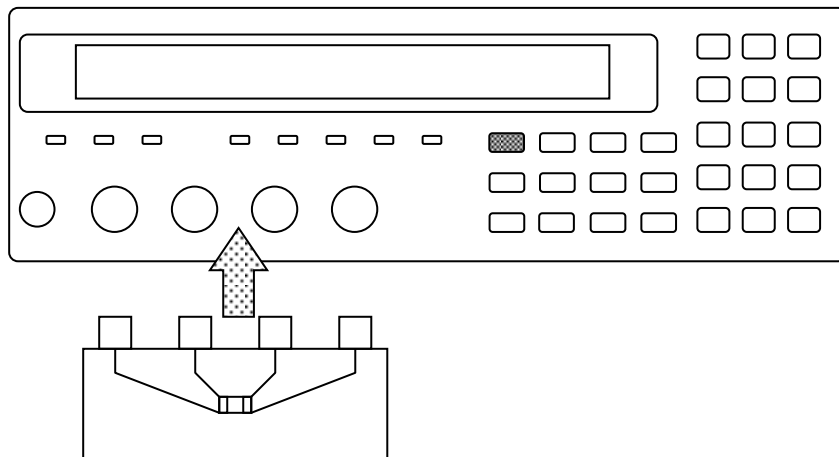

Figure 3-11 Measurement of LOAD standard value

When a test fixture is used to connect the standard (part) and the LCR meter, an exact LOAD standard value can be obtained only in lower frequencies where the additional error due to the test fixture can be ignored. In higher frequencies, the test fixture itself generates an additional error which needs the LOAD correction.

- Disables the OPEN correction and the SHORT correction.
- Measurement of LOAD standard value
Select STD-Meas in the LOAD correction menu.

SHIFT + **[LOAD]** >> LOAD correction menu >> **6** key

LOAD Correction: OFF		100Hz - 1.0MHz	
0) OFF	1) ON	2) Measure	3) SPOT
>NEXT			

Options (first page)

4) LowFREQ	5) UppFREQ	6) STD-Meas	<PREV
-------------------	-------------------	--------------------	-----------------

Options (second page)

During the measurement of LOAD standard value, the following message is displayed.

LOAD Standard Measurement	
Running	9) ABORT

The measurement of LOAD standard value can be aborted by pressing the **9** key.

When the LOAD standard value measurement is completed properly, the following completion message is displayed for a short time, and then the LOAD correction menu (first page) comes back.

Completed

If the measurement cannot be executed properly, the previous LOAD standard value is retained, and the following warning message is displayed.

Warning: Out of range

This warning will disappear when any key is operated or after several seconds have passed.

■ Measuring LOAD correction value

• Setting of measurement conditions

The LOAD correction value may vary depending of the measurement conditions such as measurement range and signal level. Thus, in principle, the LOAD correction value should be measured under the same measurement conditions as when measuring DUT. When the measurement condition is changed, it is recommended to execute the LOAD correction again. Examples of measurement conditions:

Measurement frequency, measurement signal level, measurement range, measurement speed, averaging count, triggered drive, trigger delay time, cable length, and DC bias.

If the signal level is small, the correction value may vary due to noise. If the variation is problem, increase the signal level or reduce the measurement speed to restrict it.

• Preparations of connection circuit network

Connect the same connection circuit network as when actually measuring DUT.

• Disables the OPEN correction and the SHORT correction.

• Connection of standard for LOAD correction.

Attach the standard for LOAD correction at the end of the connection circuit network for correction.

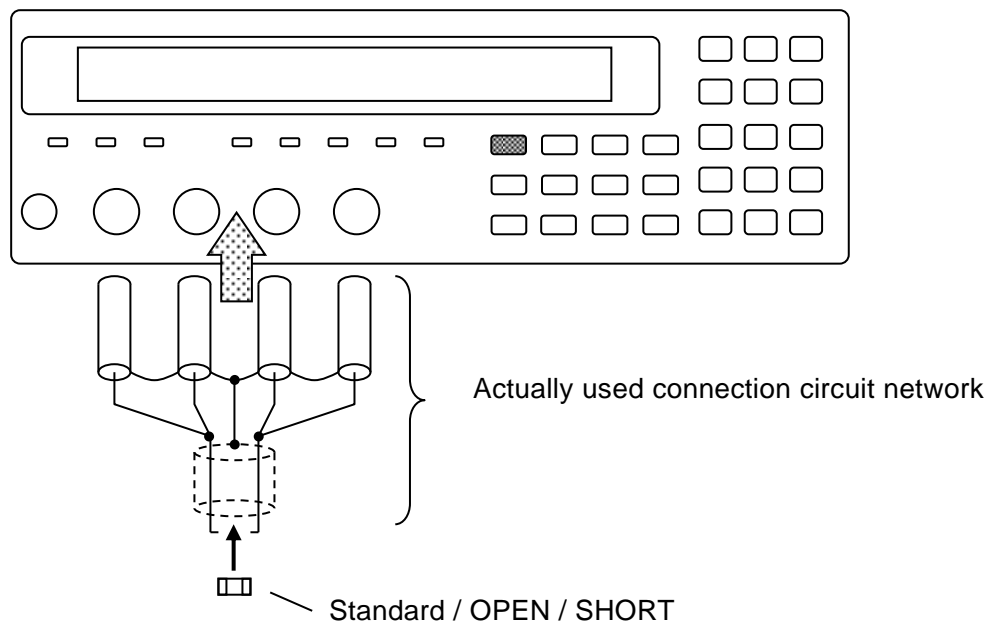

Figure 3-12 Measurement of LOAD correction value

To measure LOAD correction value, select Measure with the LOAD correction menu.

SHIFT + **[LOAD]** >> LOAD correction menu >> **2** key

LOAD Correction: OFF		100Hz - 1.0MHz	
0) OFF	1) ON	2) Measure	3) SPOT >NEXT

During the measurement of LOAD correction value, the following message is displayed.

LOAD Measurement	+/-20%
Running	9) ABORT

The measurement of LOAD correction value can be aborted by pressing the **9** key.

Upon successful completion of LOAD correction value measurement, the LOAD correction is enabled, and the following completion message is displayed for a moment, and then the measurement screen comes back.

Completed	Correction ON
------------------	----------------------

When the standard for LOAD correction is measured and the measured value different more than 20% from the set standard value is obtained, the following warning message is displayed.

Warning: Out of range

This warning will disappear when any key is operated or after several seconds have passed.

When the LOAD correction value cannot be obtained by any reason, the previous LOAD correction value is retained, and the same warning message as the above is displayed. When the warning is displayed, it is recommended to measure the standard for LOAD correction to check for failures, as in the case of usual DUT measurement. Even if the obtained LOAD correction value is out of the range of "standard value $\pm 20\%$ ", the LOAD correction is executed based on the standard value and the obtained correction value.

3.5.6.10 Cable Length Correction

The cable length correction corrects an additional error due to the connection cable between ZM2376 and DUT. ZM2376 uses coaxial cables of impedance 50Ω (cable capacitance = about 105pF/m) and the length of four cables must be same. If the cables have different characteristics, the correction cannot be performed correctly.

The cable length correction is operated with the cable length correction menu.

SHIFT + [**CABLE**]

Press the **SHIFT** + [**CABLE**] keys to display the Cable Length correction menu.

CABLE Length: 0m

0) 0m 1) 1m 2) 2m 3) 4m 4) 4m

Current setting

Options

Select the cable length with a numeric key according to the actual cable length.

4m can be selected with either **3** key or **4** key.

If a selection is made or the EXIT operation is performed, the measurement screen comes back.

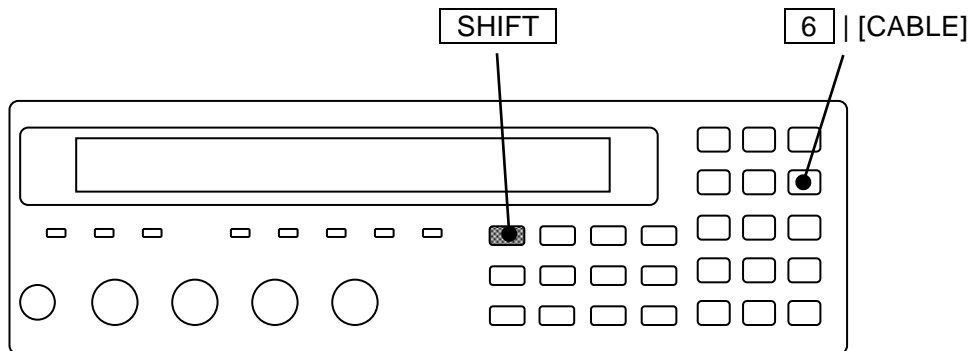

4. ADVANCED OPERATIONS

4.1 Measuring with Specific Voltage or Current (ALC)	4-2
4.2 Restricting the Variation of Measured Value (Averaging) ...	4-6
4.3 Displaying the Deviation from the Reference Value	4-7
4.4 Sorting the Part (Comparator)	4-10
4.5 Connecting to the Part handler (Handler Interface).....	4-21
4.6 Measuring with More Than One Condition (Multi-measurement)	4-30
4.7 Changing the Contents Displayed on the Second Line of Measurement Screen (Auxiliary Display).....	4-37
4.8 Saving/Recalling the Setting and Correction Value into the Memory	4-39
4.9 Setting the Contact Check	4-41
4.10 Applying the DC Bias Voltage	4-44
4.11 Applying the DC Bias Current	4-51
4.12 Disabling the Key-Operation of Panel	4-54
4.13 Changing the Settling Wait Time During Automatic Adjustment	4-55
4.14 Initializing of All Settings.....	4-56
4.15 Self-Diagnosis	4-59
4.16 Checking the Version.....	4-60
4.17 Remote Control	4-61
4.18 Switching the Operation Mode (alternative command) ...	4-62

4.1 Measuring with Constant Voltage or Current (ALC)

Enable the ALC function when the DUT is to be driven with constant voltage or constant current.

ALC: Automatic Level Control

CV: Constant Voltage

CC: Constant Current

Set or check the voltage or current value in advance when specifying the CV or CC. Otherwise, an unexpected large signal may be given to the DUT.

SHIFT + **[ALC]**

SHIFT + **[ALC]** keys to display the ALC setting menu.

Measurement signal level		
ALC:CV Source 1.2574V 0)OFF 1)CV 2)CC 3)Current		Current setting Options

- OFF Disables the ALC function (CV and CC).
- CV Enables the constant voltage function. CC is disabled.
(Voltage ↻ Measurement signal level setting menu)
- CC Enables the constant current function. CV is disabled.
(Current ↻ Current setting menu)
- Current Displays the current setting menu.

If a setting is made or the EXIT operation is performed, the measurement screen comes back.

When CV or CC is enabled, the automatically adjusted measurement signal level at the time when this menu is activated (voltage with the H_{CUR} terminal opened) is displayed at the bottom right. The measurement error depends on this signal level. Note that the measurement error can increase at a low signal level.

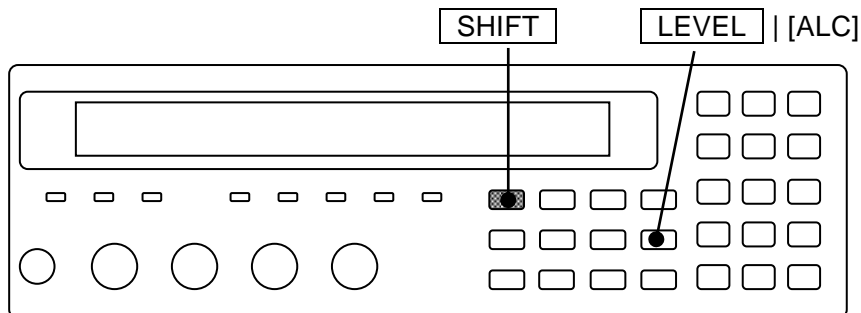

When ALC function is enabled, “c” is displayed before the measurement signal level.

• • • • • • • •	1.00000M	Measurement frequency Hz
• • • • • • • •	c1.00 V <small>ww</small>	Voltage Vrms
• • • • • • • •	c1.00mA <small>ww</small>	Current Arms

⚠ CAUTION

With the constant voltage function enabled, if the DUT is removed after small impedance was measured, the maximum 5Vrms signal may be output.

With the constant current function enabled, if the measurement terminals are opened, the maximum 5Vrms signal may be output.

Current: The current setting menu is as follows.

Current: 1.00mA	Current setting
0.0010mA to 200mA	Available value ranges

The setting resolution is 3 digits (0.1μA when < 10μA).

If a setting is made or the EXIT operation is performed, one-previous menu comes back.

When the ALC function (CV or CC) is enabled, ZM2376 repeats the measurement while adjusting the measurement signal level until the following values are obtained.

CV: Voltage monitored value is the set value $\pm 1\%$ of set value.

CC: Current monitored value is the set value $\pm (1\% \text{ of set value} + 0.02\% \text{ of max. drive / detection current in measurement range})$

Accordingly, the measurement will take time.

When the measurement range is automatic selection, first the measurement range is selected and determined. Then, the measurement signal level is changed in a range of 10mVrms to 5Vrms to adjust to the specified voltage or current. It cannot be adjusted to a value that exceeds the maximum current or voltage which can be detected with the measurement range.

There are the following other restrictions.

- Due to the characteristic variations of ZM2376, the voltage or current may not be adjusted to settable maximum voltage or maximum current.
- The upper limit of the adjustable range of the measurement signal level is restricted to 1.2V in the following conditions.

Rd: Minimum output impedance

Rd = 25Ω-100 CV is enabled, and the signal level $\leq 1.05\text{Vrms}$

Rd = 6Ω-100-f1k CV is enabled, and the signal level $\leq 1.05\text{Vrms}$

CC is enabled, and the current setting $\geq 40\text{mA rms}$

- When the DC bias output is on, the DC bias voltage takes precedence, and the adjustable range of the measurement signal level is restricted as follows.

Measurement signal level $< 5 - (\text{DC bias voltage setting value [V]} \times 0.7071 [\text{Vrms}])$

When the auto DC balance function is enabled, use the following value instead of the DC bias setting value.

DC bias voltage setting value[V] + 0.25[V] (up to 5[V])

- With a DC bias currency (leak current), the adjustable range decreases.
- When the voltage-current characteristic of DUT is extremely nonlinear or the value changes in short term, the specified voltage or current cannot be obtained, and an error occurs (measurement value ALC Err) even though the measurement signal level is adjusted repeatedly.

4.1 Measuring with Constant Voltage or Current (ALC)

When you measure a high-dielectric type ceramic capacitor that has nonlinear characteristic, it is recommended to use up to about $10\mu\text{F}$ at 1kHz and about $100\mu\text{F}$ at 120Hz . The measured value may change due to signal distortion, when the voltage drop caused by the output impedance increases.

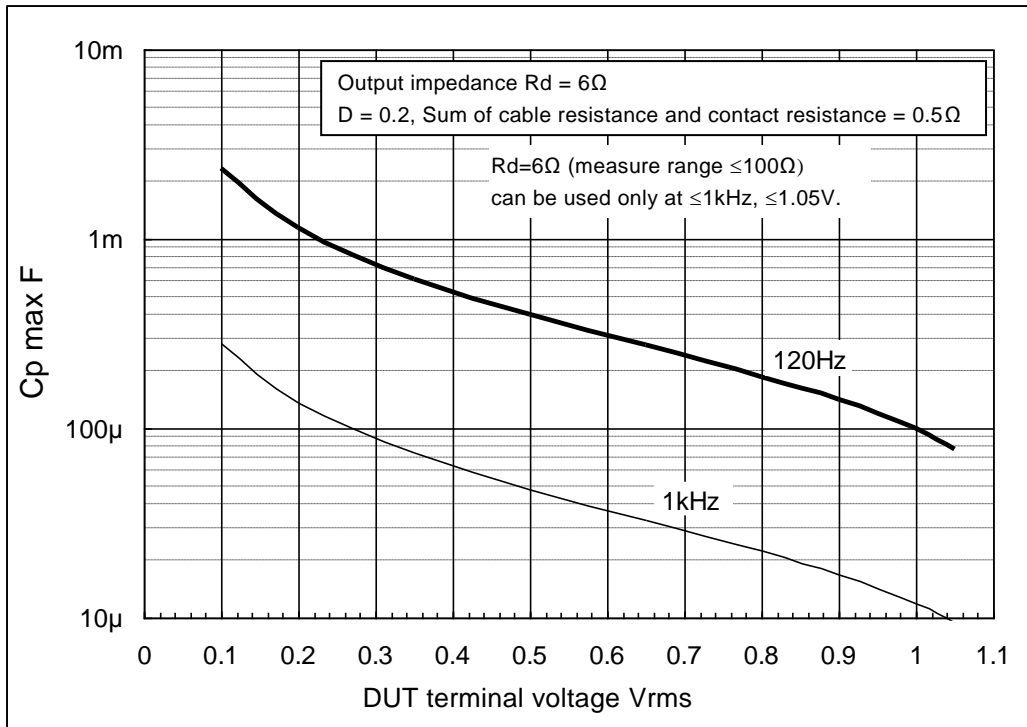

Figure 4-1 Maximum capacitance measurable at constant voltage (supplementary value)

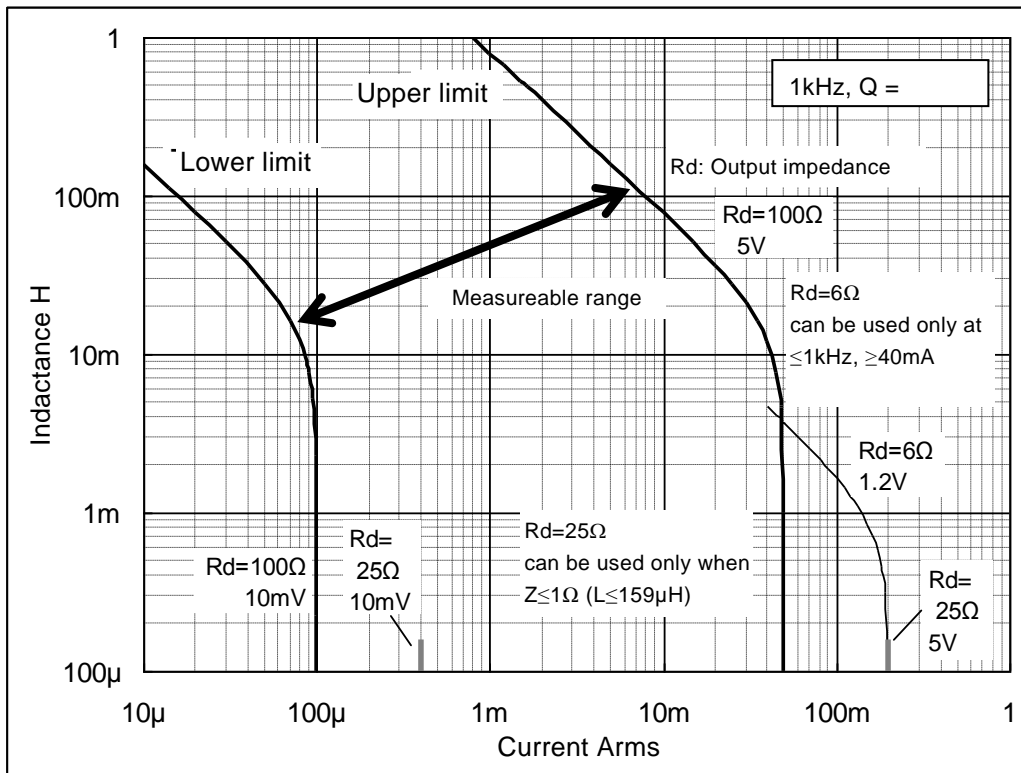

Figure 4-2 Inductance range measurable at constant voltage (supplementary value)

4.2 Restricting the Variation of Measured Value (Averaging)

When measured values vary due to the noise, it is able to restrict the variation by the averaging function.

SHIFT + **AVERAGE**

Press the **SHIFT** + **AVERAGE** keys to display the averaging count setting menu.

Averaging times = 256, ON	Current setting
1 to 256	Available value ranges

Enter the averaging count with the numeric key, and press the **ENTR** key.

If a setting is made or the EXIT operation is performed, the measurement screen comes back.

If the averaging count is set to “1”, the averaging function is disabled (OFF).

If the averaging count is set to “2 to 256”, the averaging function is enabled (ON).

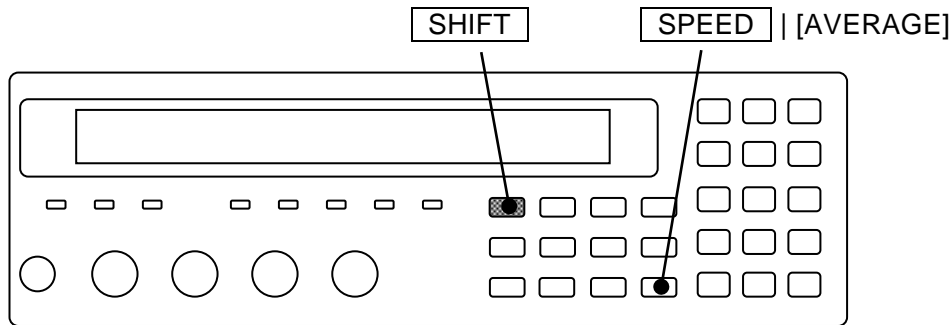

The current averaging count is displayed on the second line in measurement screen.

A100kΩ FAST 256 Int OpShLd1m
SPEED/AVERAGE

Averaging count: 1 ~ 256

When the averaging function is enabled, the signal acquisition time becomes the multiple number of the averaging count. To sensitively adjust the measurement speed in consideration of the balance with the variation or fluctuation of measured values, speed up the measurement speed and adjust it by the averaging count.

Even if the measurement speed is RAP or FAST, increase the averaging count, so that the measurement accuracy achieved when measurement speed is MED can be used when the signal acquisition time of MED is exceeding.

4.3 Displaying the Deviation from the Reference Value

It is able to display the deviation or deviation% from the reference value of measured values.
 To display the deviation or deviation%, previously specify the given primary and secondary parameters. Also, set the reference value for obtaining the deviation.

■ Displaying the deviation of primary parameter

SHIFT + [**ΔPri**]

SHIFT + [**ΔPri**] keys to display the Displaying the deviation of primary parameter menu.

Display format		Reference value for deviation display		
Deviation Pri:ABS		REF:+1.23456μF		Current setting
0)ABS	1)DEV	2)DEV%	3)REF	Options
ABS	Displays the measured value as is. (default value)			
DEV	Displays the deviation from reference value. Deviation = Measured value – Reference value			
DEV%	Displays the deviation % from the reference value. Deviation % = ((Measured value – Reference value) / Reference value) × 100			
REF	Display the reference value setting menu of primary parameter.			

Select one of ABS, DEV or DEV% as the display format with the numeric key.

To display the deviation or deviation%, previously set the reference value.

If a setting is made or the EXIT operation is performed, the measurement screen comes back.

REF: The reference value setting menu of the primary parameter is as follows.

Pri Reference:+1.23456μF	Current setting
±(0.0000p to 999999M)	Available value ranges

Enter the numeric value and use the **ENTR** key or the exponential part input **EXP** + [**μ**] keys for instance. If a setting is made or the EXIT operation is performed, one-previous menu comes back.

When the deviation or deviation% is selected, the “Δ” displayed in front of measured value of primary parameter.

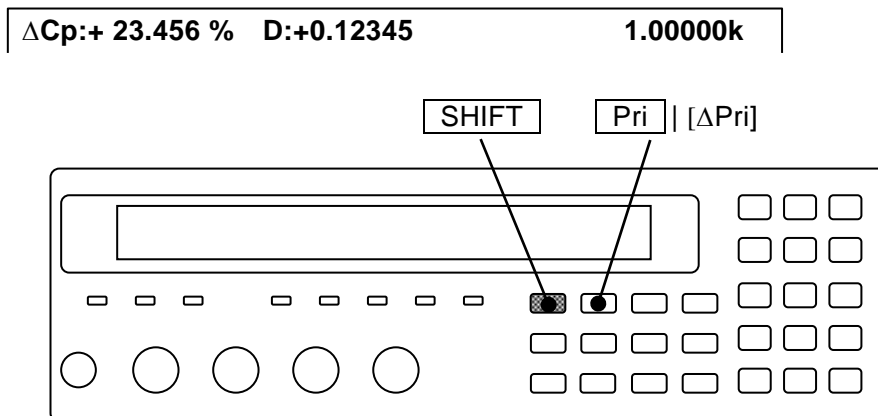

■ Displaying the deviation of secondary parameter

SHIFT + [Δ Sec]

SHIFT + [Δ Sec] keys to display the Displaying the deviation of secondary parameter menu.

Display format		Reference value for deviation display		
Deviation Sec:ABS		REF:+1.23456		Current setting
0)ABS	1)DEV	2)DEV%	3)REF	Options

ABS Displays the measured value as is. (Initial value)

DEV Displays the deviation from reference value.

Deviation = Measured value – Reference value

DEV% Displays the deviation % from the reference value.

Deviation % = ((Measured value – Reference value) / Reference value) × 100

REF Display the reference value setting menu of secondary parameter.

Select one of ABS, DEV or DEV% as the display format with the numeric key.

To display the deviation or deviation%, previously set the reference value.

If a setting is made or the EXIT operation is performed, the measurement screen comes back.

REF: The reference value setting menu of the secondary parameter is as follows.

Sec Reference:+1.23456	Current setting
±(0.0000p to 999999M)	Available value ranges

Enter the numeric value and use the **ENTR** key or the exponential part input **EXP** + [μ] keys for instance. If a setting is made or the EXIT operation is performed, one-previous menu comes back.

When the deviation or deviation% is selected, the “ Δ ” displayed in front of measured value of secondary parameter.

Cp:+12.3456μF ΔD :+0.12345	1.00000k
--	-----------------

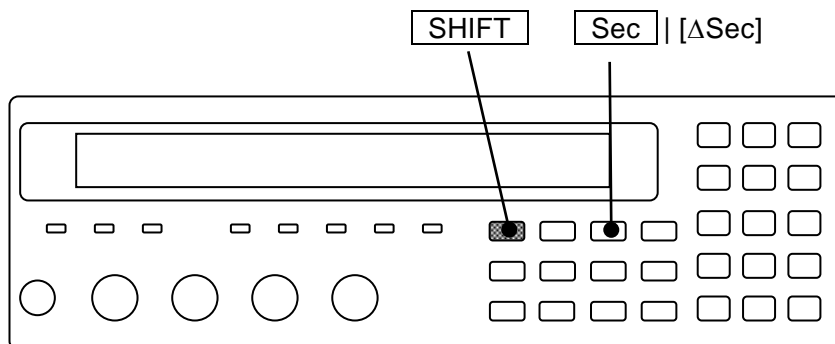

The displaying ranges for deviation% both for primary and secondary parameters are shown as follows:

Deviation% $\pm(0.000 \text{ to } 999.999)$, Fixed decimal place

The unit of reference value depends on the parameter (ex. $Z \rightarrow \Omega$, $\theta \rightarrow ^\circ$).

When the parameter is changed, the unit to be displayed is also changed (ex. C, 2.2mF \rightarrow L, 2.2mH).

When the primary or secondary parameter to be displayed is changed, the display is changed from the one of deviation and deviation% into the other of original measured value as is for both primary and secondary parameters. To display the deviation or deviation%, previously set the given primary and secondary parameters. Also confirm that “ Δ ” is displayed in front of measured value.

The display format for measured value and the comparison format for comparator are common. Also the reference value for obtaining the deviation is common for both display and comparator. For both primary and secondary parameters, even if either display or comparator is set up, the same display format or comparison format or reference value is obtained.

4.4 Sorting the Part (Comparator)

For ZM2376, up to 14 bins for primary parameter and one set range for secondary parameter can be set to sort the comparison results.

■ Limit comparison

The remote control allows the use of limit comparison function wherein sorting is done while upper/lower limit (one set) of primary parameter and upper/lower limit (one set) of secondary parameter are being set. The limit comparison function is not made into effect through the panel.

Once the limit comparison function is made into effect, independent of the setting for Bin sorting, comparison can be done only for one set (common to BIN1 for Bin sorting) of upper/lower limit values of primary parameter and one set (common to secondary parameter for Bin sorting) of upper/lower limit values of secondary parameter. In this case, the comparison for Bin 2 to BIN14 is not conducted.

For detail, see the explanation for the following commands stated in “ZM2376 Instruction Manual (Remote Control)”.

:CALCulate:COMParator[:STATe] Command

:CALCulate1:LIMit Subsystem Command

:CALCulate2:LIMit Subsystem Command

When you use alternative commands, see the explanation for the following command stated in “ZM2376 Instruction Manual (Alternative Commands)”.

:COMParator Subsystem Command

■ Multi-measurement

In the multi-measurement function, which measures with more than one condition, the comparator and handler interface operate in a slightly different way.

Details •••  “4.6 Measuring with More Than One Condition (Multi-measurement)”

■ Output of comparator result

The comparator result are displayed on the front panel and also output from the Handler interface of rear panel. The relation between measured values of primary/secondary parameters, setting of upper/lower limit values and comparator result is as follows.

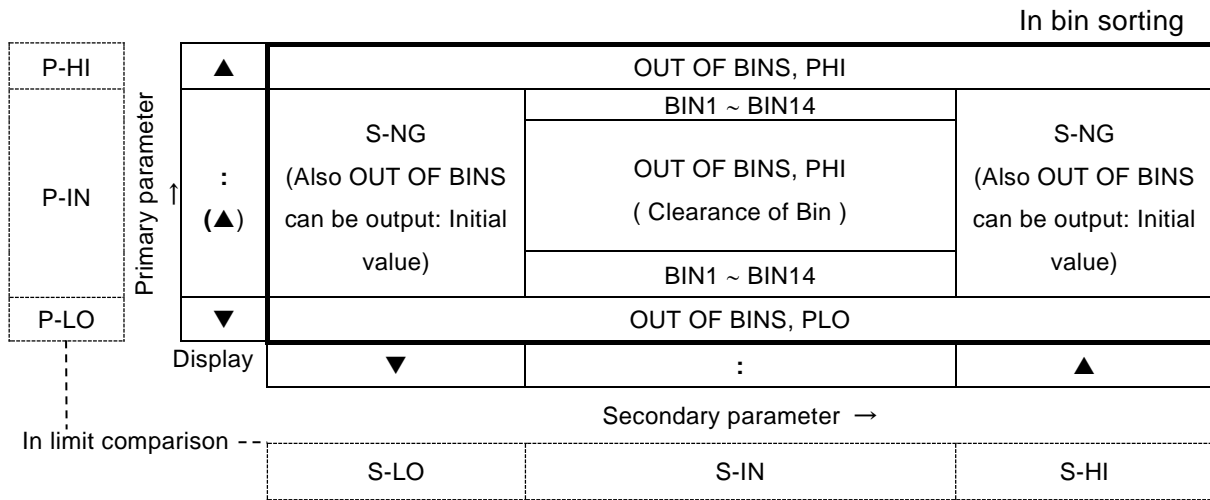

Figure 4-3 Output of comparator result

Signal name ☞ “4.5 Connecting to the Part Handler (Handler Interface)”

The limit comparison also conducts the following comparison. The parameter, which does not conduct comparison, should be regarded as pass one.

- IN Both primary parameter and secondary parameter are passed
 - OUT OF BINS Either or both of primary and secondary parameters is failed (initial value)
 - S-NG Primary parameter is acceptable but secondary parameter is failed.
- However, when the correct value cannot be obtained due to an error, it can be classified as P-HI, S-HI.

■ Displaying the measured value when comparator function is enabled

When comparator function is enabled, the COMPTR lamp on the left of front panel lights up. The measured values are displayed as follows when comparator function is enabled.

<p>▲ The primary parameter is larger than any upper limits or is between Bins.</p> <p>: The primary parameter is within one of Bins or comparison of primary parameter is not conducted.</p> <p>▼ The primary parameter is less than any lower limits.</p>	<p>ERR</p> <p>NC</p> <p>LoC: Low C</p> <p>OUT: OUT OF BINS</p> <p>SNG: S-NG</p>	<p>1~14: Bin No.</p> <p>IN</p>
<p>Comparison result</p>		
<p>Cp:+12.3456μF D:+0.12345 12 1.00000k</p> <p>• • • • • • • •</p>		
<p>▲ The secondary parameter is larger than the upper limit.</p> <p>: The secondary parameter is within the upper/lower limit range or comparison for secondary parameter is not conducted.</p> <p>▼ The secondary parameter is less than lower limit.</p>		

The upper or lower limit values of comparator can be displayed on the lower line.

For details •••  “4.7 Changing the Contents Displayed on the Second Line (Auxiliary Display)”

■ Setting the comparator

The comparator function is set with the comparator setting menu.

SHIFT + [**COMPRTR**]

Press the **SHIFT** + [COMPRTR] keys to display the comparator setting menu.

At limit comparison L/U

Comparator function ON/OFF

Comparison format of primary parameter

Comparator:OFF		ABS		Current setting
0)OFF	1)ON	2)DEV	>NEXT	Options (first page)
3)CLEAR	4)LIMIT	<PREV		Options (second page)

- OFF Disables the comparator function (Bin sorting). (Default value)
- ON Enables the comparator function (Bin sorting).
- DEV Displays the primary parameter deviation comparison menu for comparator.
- CLEAR Displays the comparator initializing menu.
- LIMIT Displays the comparator upper/lower limit setting menu.
- L/U Appears when primary or secondary parameter limit comparison function is enables. The limit comparison function cannot made enabled through the panel. Turning on/off of comparator function disables the limit comparison function of primary/secondary parameters.

If a setting is made or the EXIT operation is performed, the measurement screen comes back.

COMPRTR lamp

When the comparator function is enabled, the **COMPRTR** lamp on front panel lights up.
It also lights up when the limit comparison function is enabled.

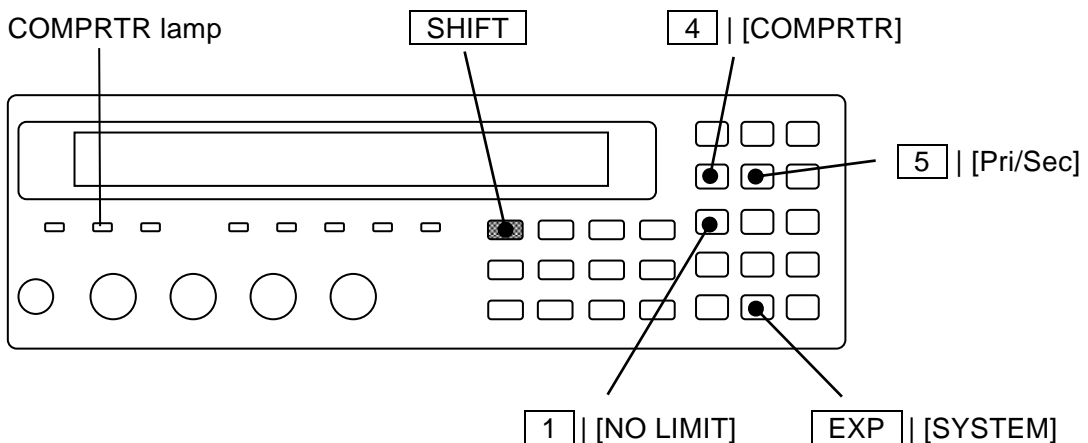

■ **Sorting the primary and secondary parameters with the deviation**

When the primary and secondary parameters are display format of deviation or deviation%, they are sorted by the values of deviation or deviation%.

The comparison format of primary parameter can be set in the comparator setting menu. Since the comparison format (=Display format) and the reference value for obtaining a deviation are common to both display and comparator, they may be set for either display or comparator.

Since it is impossible to set the comparison format of secondary parameter in the comparator setting menu, alternatively use the setting for display format.

Select the DEV with the comparator setting menu, the primary parameter deviation comparison menu for the comparator is displayed.

DEV: The primary parameter deviation comparison menu is as follows:

Comparison format		Reference value for deviation comparison		Current setting Options
0)ABS	1)DEV	2)DEV%	3)REF	
ABS	Conducts the comparison according to the original measured values. (Default value)			} Comparison format
DEV	Conducts the comparison according to the deviation from the reference values.			
DEV%	Conducts the comparison according to the deviation% value from the reference values.			
REF	Displays the primary parameter reference value setting menu for the comparison of deviation.			

Select one of ABS, DEV or DEV% as the comparison format by the numeric key.

To display the deviation or deviation%, previously set the reference value.

If a setting is made or the EXIT operation is performed, one-previous menu comes back.

REF: The deviation comparison of primary parameter reference value setting menu is as follows.

DEV Reference:+1.23456μF ±(0.0000p to 999999M)	Current setting Available value ranges
---	---

Enter the numeric value and the exponential part input **EXP** + **[μ]** keys for instance, decides by the **ENTER** key.

If a setting is made or the EXIT operation is performed, one-previous menu comes back.

■ The display format for the lower/upper limit values and reference values, and unit

The lower limit value, upper limit value and reference values are construed according to the type of measurement parameter or the display format.

For example, “F” is used as the unit of lower/upper limit value when displaying/sorting the capacitance (C) by the absolute value or deviation, meanwhile “%” is used as the unit when displaying/sorting the capacitance by the deviation%.

The following table shows an example when the measurement parameters are set to inductance (L), lower limit value=1, upper limit value=2, and reference value=3.

Table 4-1 Display format of measured value and interpretation of setting value (example of L)

Display format	Lower limit value (=1)	Upper limit value (=2)	Ref. value (=3)
ABS	1H	2H	3H
DEV	Deviation is 1H (Equivalent to 4H for original measured value)	Deviation is 2H (Equivalent to 5H for original measured value)	3H
DEV%	Deviation is +1% (Equivalent to 3.03H for original measured value)	Deviation is +2% (Equivalent to 3.06H for original measured value)	3H

■ Initializing the setting of comparator

To newly set the upper/lower limit value of comparator, it will be convenient to initialize the setting at first.

To initialize the upper/lower limit value, select the CLEAR in the comparator setting menu, and the following comparator initializing menu is displayed.

Comparator CLEAR 1)Execute	Options
Done	Completion message

Perform the EXIT operation to return to one-previous menu.

Press the 1 key to execute the initialization, and the completion message will be displayed for a short time, and then one-previous menu will come back.

Table 4-2 Initialization contents of comparator

Item	Initial value	Item	Initial value
Comparator function (Bin sorting)	OFF	Limit comparison	OFF
Sorting for BIN1	ON	All upper limit values (Value, ON/OFF)	0,OFF (No Limit)
Sorting for BIN2 to BIN14	OFF	All lower limit values (Value, ON/OFF)	0,OFF (No Limit)
Comparison of secondary parameter	ON	-----	-

The display format and comparison format are not initialized.

■ Setting the upper/lower limit value of comparator

To sort the parts, set the upper/lower limit values of primary/secondary parameters.

Select the LIMIT with the comparator setting menu, and the comparator upper/lower limit value setting menu (shown below) is displayed.

Examples of primary parameters (C):

When the comparison format is either ABS or DEV while the cursor is at either upper or lower limit:

<u>Bin</u>	<u>Enable/disable</u>	<u>Lower limit value</u>	<u>Upper limit value</u>	
<BIN1	ON	Lo:+1.23456μF	Hi:+1.23456μF>	Current setting
±(0.0000p to 999999M)				Available value ranges

Examples of secondary parameters (D):

When the cursor is at either lower or upper limit:

<u>Enable/disable</u>	<u>Lower limit value</u>	<u>Upper limit value</u>	
< Sec OFF	Lo:+10.0000μ	Hi:+100.000m >	Current setting
±(0.0000p to 999999M)			Available value ranges

Move the cursor to the point of parameter you need to set (mentioned later) and set the value.

The unit depends on each parameter.

Perform the EXIT operation to return to one-previous menu.

■ Sorting DUTs into bins by the measured values of primary parameter

To sort DUTs into plural bins, set the upper/lower limit values for each bin for sorting.

The DUT is sorted in order from the smaller number of bin. Therefore, if the range of each bin is overlapped, the DUT is sorted into the bin of the smallest number. If the DUT does not fall in any bin range, it is sorted as "OUT OF BINS".

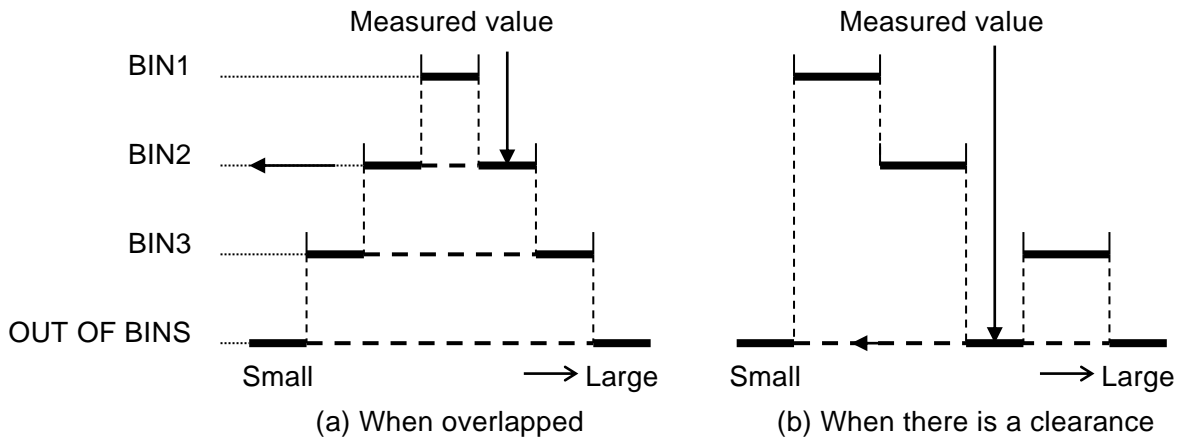

Figure 4-4 Range setting and comparison when sorting into bins

■ Moving the cursor in the comparator upper/lower limit value setting menu

The cursor is placed at the point of parameter to be set in comparator upper/lower limit value setting menu. The initial cursor position is at lower limit value of BIN1.

The cursor can be moved by pressing the **[BS]** | [PREV] key or **[EXP]** | [NEXT] key. It moves not only between enable and disable of range comparison or between lower and upper limit values but more the between Bins or between primary parameter and secondary parameter.

Pressing the **[EXP]** | [NEXT] key causes the cursor to be moved as below.

- (Secondary parameter upper limit) → (BIN1 enabled → lower limit → upper limit)
- (BIN2 enabled → upper limit → lower limit)
- ...
- (BIN14 enabled → upper limit → lower limit)
- (Secondary parameter enabled → lower limit → upper limit)
- (BIN1 enabled)

Pressing the **[BS]** | [PREV] key causes the cursor to be moved in the reversed order.

[SHIFT] + [Pri/Sec]

With the comparator upper/lower limit value setting menu, pressing the **[SHIFT]** + [Pri/Sec] keys causes the cursor to be moved between primary and secondary parameter.

When switched from primary parameter (BIN) into secondary parameter, the cursor moves to the lower limit value of secondary parameter.

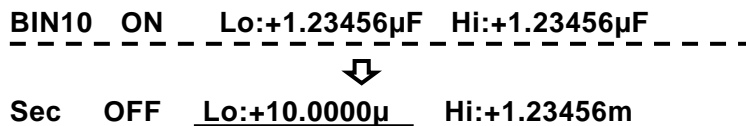

When switched from secondary parameter into primary parameter (BIN), the cursor moves to the lower limit value of BIN1.

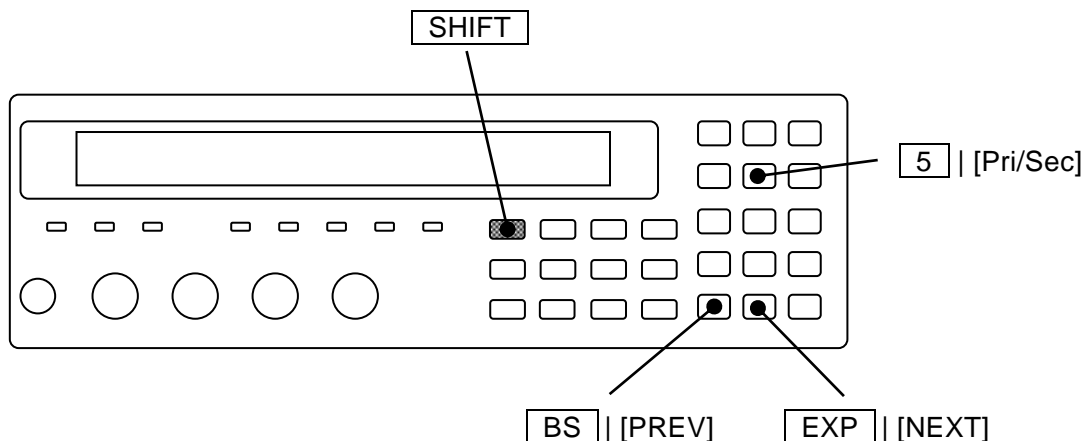
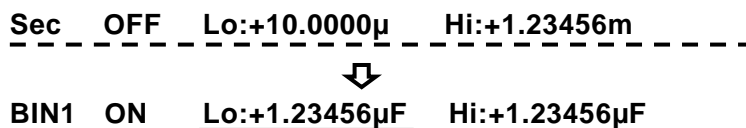

■ Enabling/disabling the range comparison

To make comparison using the comparator, set not only the upper/lower limit value but also “ON or OFF” for the comparison.

If the cursor is at the position of ON/OFF, it is able to set “ON or OFF” for the comparison of primary parameter’s Bin or secondary parameter where the cursor is placed.

Example of range comparison: When the cursor is at ON/OFF position

<BIN11	OFF	Lo:+1.23456μF	Hi:+1.23456μF>	Current setting
0)OFF	1)ON			Options

ON Enables the range comparison for one set of upper/lower limit values

OFF Disables the range comparison for one set of upper/lower limit values

When the comparison of secondary parameter is disabled, the comparison for secondary parameter is not conducted but only the comparison for each Bin of primary parameter can be done (S-LO/S-IN/S-HI and S-NG are not output).

When “OFF” is set for specific Bin of primary parameter, the comparison for LO/IN/HI for that Bin is not conducted and the DUT is not sorted into that Bin. When such setting is made that the comparison for all Bins (1 to 14) of primary parameter is not conducted, the DUT is always sorted into “OUT OF BINS”.

Note that, even if range comparison is set to “Enable(ON)”, it cannot be sorted for the given Bin in case of lower limit value \geq upper limit value. Substantially the comparison for upper/lower limit value is not conducted.

- Disabling only either side of lower or upper limit

SHIFT + [**NO LIMIT**]

With the comparator upper/lower limit setting menu, pressing the **SHIFT** + [**NO LIMIT**] keys causes the comparison of the lower or upper limit value on cursor to be disabled and the comparison is not conducted.

<BIN2 ON Lo:+1.23456 μ F Hi: No limit>

Once both of lower and upper limit values for the Bin (primary parameter) are disabled, it becomes the same state as is the case when the range comparison of Bin is disabled.

Once both of lower and upper limit values for the secondary parameter are disabled, it becomes the same state as is the case when the range comparison of secondary parameter is disabled.

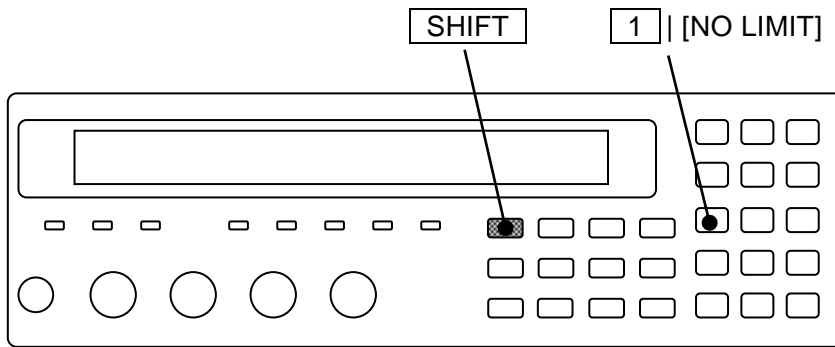

■ Sounding the beep sound depending on the comparator result

It is able to sound the beep sound according to the comparator result.

The beep sound can be set in the system setting menu.

SHIFT + [**SYSTEM**]

Press the **SHIFT** + [SYSTEM] keys to display the system setting menu.



Press the **1** key to select the BEEPER, and the beeper setting menu is displayed.

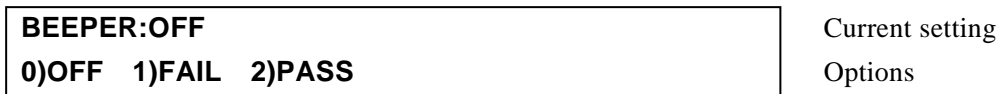

OFF Disables the beeper (Beep sound stops).

FAIL When the comparator result is failed (other than BIN1 to BIN14), sounds the beeper.

PASS When the comparator result is passed (BIN1 to BIN14), sounds the beeper.

In case that the limit comparison is enabled: it should be regarded as “PASS” when comparison result is IN or be regarded as “FAIL” in other cases.

After setting, the results are displayed for a short time and return to one-previous menu.

Perform the EXIT operation to return to one-previous menu.

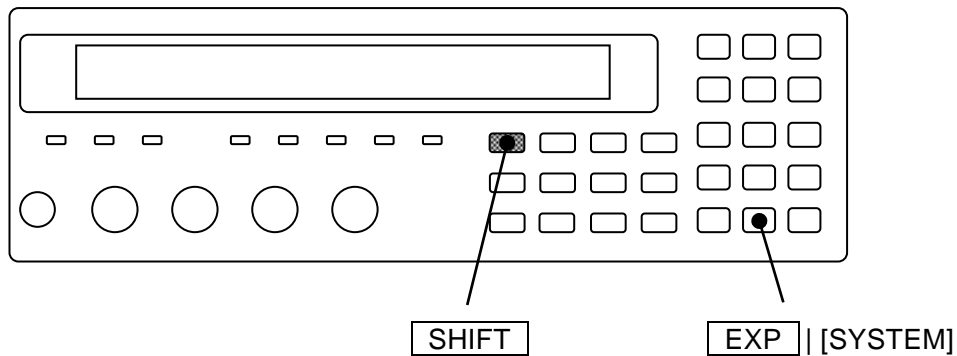

4.5 Connecting to the Part handler (Handler Interface)

For the ZM2376, the comparator result can be output into the handler interface of rear panel. Connecting to the part handler allows auto part sorting system to be configured.

Table 4-3 Handler interface signal layout

Pin No.	I/O	Signal name	Pin No.	I/O	Signal name
1	IN	TRIG, /TRIG	26	IN	/RCL0
2	IN	/RCL1	27	IN	/RCL2
3	IN	/RCL3	28	IN	/RCL4
4	IN	/RCL5	29	IN	/RCL6
5	IN	/RCL-VALID	30	OUT	/BIN1, /P-HI
6	OUT	/BIN2, /P-IN	31	OUT	/BIN3, /P-LO
7	OUT	/BIN4, /S-HI	32	OUT	/BIN5, /S-IN
8	OUT	/BIN6, /S-LO	33	OUT	/BIN7, /IN
9	OUT	/BIN8	34	OUT	/BIN9
10	OUT	(/BIN10)	35	OUT	(/BIN11)
11	OUT	(/BIN12), /NC	36	OUT	(/BIN13), /PHI
12	OUT	(/BIN14), /PLO	37	OUT	/OUT OF BINS
13	OUT	/INDEX	38	OUT	/EOM
14	OUT	/ERR	39	OUT	/S-NG
15	IN	/KEY_LOCK	40	- - -	(reserved)
16~20	IN	EXT DCV	41~45	OUT	INT DCV
21~25	IN	EXT COM	46~50	OUT	INT COM

- The “/” at the top of signal name shows the negative logic where “low level” specifies “1”.
- The “()” shows the signal when number of Bin is expanded (/NC, /PLO and /PHI are not output).

Extending the Bin number

•••  “**■** Extending the Bin number of primary parameter”

- **reversed character** shows the output signal in case of limit comparison. /BIN1 to /BIN14, /PHI and /PLO are not output in case of limit comparison.

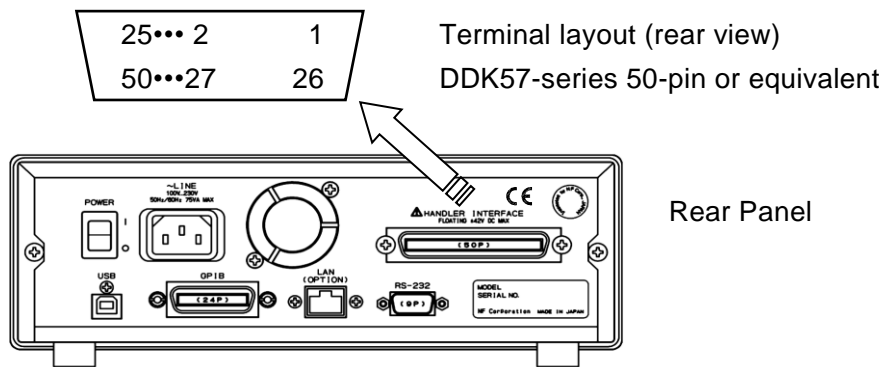

4.5 Connecting to the Part handler (Handler Interface)

Table 4–4 Functions of handler interface signal

Pin No.	I/O	Signal name	Description
1	IN	TRIG, /TRIG	External trigger signal (rising edge). Can be switched into falling edge.
26	IN	/RCL0(LSB)	Setting/correction value memory selection signal (Binary) When /RCL-VALID is 1 (low level) and trigger source is external (Ext): once the external trigger signal of Pin No.1 is received, the memory specified by this signal allows the setting and correction value to be recalled and measurement is conducted under those conditions. Recall of memory number out of the range may result in an error.
2	IN	/RCL1	
27	IN	/RCL2	
3	IN	/RCL3	
28	IN	/RCL4	
4	IN	/RCL5	Not in use. Do not connect anything.
29	IN	/RCL6(MSB)	Not in use. Do not connect anything.
5	IN	/RCL-VALID	It shows that the memory selection signal is valid.
30	OUT	/BIN1, /P-HI	<p>/BIN1 to /BIN14: Bin sorting signal /BIN10 to /BIN14 are output when Bin expansion is enabled besides the limit comparison is disabled.</p> <p>/NC: Contact failure or Low C /PHI: primary parameter upper limit over signal /PLO: primary parameter lower limit under signal /NC, /PHI and /PLO are output only when Bin expansion is disabled (default value).</p> <p>/P-HI, /P-IN, /P-LO: Primary parameter comparison signal</p> <p>/S-HI, /S-IN, /S-LO: Secondary parameter comparison signal</p> <p>/IN: Primary/secondary total pass comparison signal</p> <p>When limit comparison is enabled, Bin sorting signals of "/BIN1 to/BIN14" are output in place of /PHI and /PLO.</p> <p>Also for the limit comparison, /NC, /ERR, /OUT OF BINS (invert of /IN) and /S-NG (/S-HI or /S-LO) are output.</p>
6	OUT	/BIN2, /P-IN	
31	OUT	/BIN3, /P-LO	
7	OUT	/BIN4, /S-HI	
32	OUT	/BIN5, /S-IN	
8	OUT	/BIN6, /S-LO	
33	OUT	/BIN7, /IN	
9	OUT	/BIN8	
34	OUT	/BIN9	
10	OUT	--- /BIN10	
35	OUT	--- /BIN11	
11	OUT	/NC, /BIN12	
36	OUT	/PHI, /BIN13	
12	OUT	/PLO, /BIN14	
37	OUT	/OUT OF BINS	Fail comparison signal
13	OUT	/INDEX	Signal acquisition end signal. Once it becomes "1" (low level), it is possible to switch into next DUT.
38	OUT	/EOM	End of measurement signal. Once it becomes "1"(low level), the comparison result become valid and it is possible to read.
14	OUT	/ERR	Measurement error signal. It shows excessive voltage or current, contact failure (NC), ALC failure or other errors.
39	OUT	/S-NG	Secondary parameter fail comparison signal
15	IN	/KEY_LOCK	Key lock signal. Once it becomes "1"(low level), it disables all key-operations of panel. It cannot be canceled through the panel or remote control.
40	---	(reserved)	Not in use. Do not connect anything.
16 ~20	IN	EXT DCV	External DC power input (+5V to +24V)
21 ~25	IN	EXT COM	External DC power input (common) Each signal of handler interface is isolated from the case and operates with the external DC power.
41 ~45	OUT	INT DCV	Internal DC power output (+5V)
46 ~50	OUT	INT COM	Internal DC power output (common) It is connected to the enclosure. To operate the Handler interface with the Internal DC power source, make connection between EXT COM and INT COM and also between EXT DCV and INT DCV.

- /BIN1 to /BIN14, /OUT OF BINS, /S-NG, /PLO and /PHI are not output when /ERR is output.

In case of limit comparison, it is justified as “/P-HI and /S-HI” when /ERR is output.

■ Electrical characteristics of handler interface

External power	Rated voltage +5V to +24V, Operation range +4.5V to +26.4V Max power consumption 45mA(5V) / 100mA(12V) / 180mA(24V)
Internal power	+5V typ, 70mA max, Common is grounded to the case
Isolation	42Vpk.(Each signal, Common) vs. case When Internal DC power output terminal is connected with External DC power input, isolation is not provided.

Output characteristics

Output low level	0.5V max (Power voltage 5V, Sink current 6mA) 1.2 V max (Power voltage 12V, Sink current 8mA) 2.4 V max (Power voltage 24V, Sink current 10mA)
Output high level	5 to 24V (Depend on power voltage)

Input characteristics (Trigger excluded)

Input low level	(Power voltage - 4.1V) max
Input high level	(Power voltage - 1.1V) min

Input characteristics (Trigger)

Input low level	(Power voltage × 0.3) max
Input high level	(Power voltage × 0.7) min

⚠ WARNING

Do not apply the voltage more than 42Vpk onto the signals or common of handler interface versus case. Otherwise, you may feel an electric shock.

⚠ CAUTION

Do not apply the voltage more than 42Vpk onto the signals or common of handler interface versus case. Otherwise, the ZM2376 may be damaged.

■ Handler interface I/O equivalent circuit

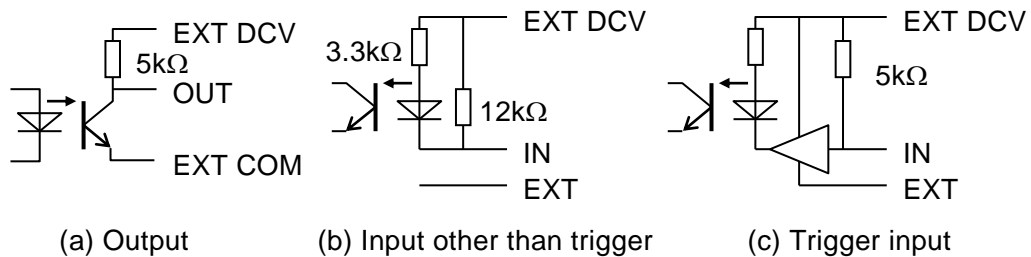

Figure 4–5 Equivalent circuit of handler interface

■ Handler interface operation timing

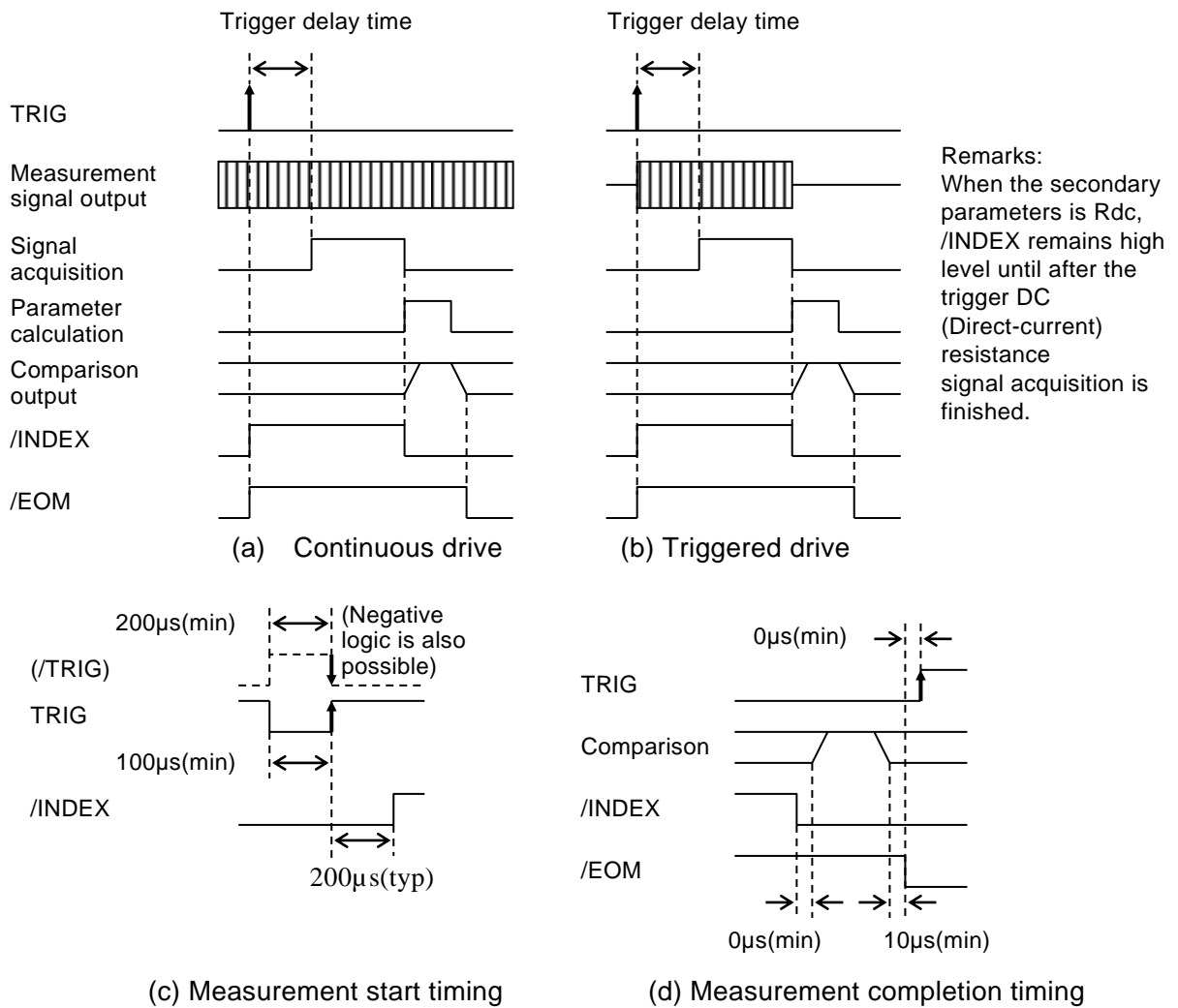

Figure 4-6 Handler interface operation timing

■ Cable length of handler interface

It should be preferably within 5m, or should not exceed 15m maximum. Use the shielded cable to avoid noise emission and contamination.

■ Relation between enabled/disabled of comparator and handler interface signal

When the comparator is disabled, handler interface output is as below:

- Comparison signal (Terminal corresponding to /BIN1 to /BIN14, /OUT OF BINS, /S-NG, or /ERR): Fixed to high level (not output).
- /EOM, /INDEX: Fixed to low level (always output).

The output immediately after power turned on is the same as above as well. Also, the same state is established by the initializing operation with the initialize menu or system setting menu or by the *RST command.

Regardless of enabled/disabled of comparator, input of handler interface is always enabled.

- Input: TRIG, /KEY_LOCK, /RCL0~/RCL6, /RCL-VALID

■ Adjusting the function of handler interface

SHIFT + [**HANDLER**]

Press the **SHIFT** + [HANDLER] keys to display the handler interface setting menu.

Handler			
0)OUT OF BINS	1)BIN10-14		>NEXT
2)TRIG Polarity	3)RCL		< >
4)TEST			<PREV

Options (first page)
Options (second page)
Options (third page)

- OUT OF BINS OUT OF BINS Output setting menu
- BIN10-14 Bin extension menu
- TRIG Polarity Polarity setting menu of trigger input signal
- RCL Setting menu of memory selection signal
- TEST Handler interface test menu

Use each function after selecting the sub menu.

Perform the EXIT operation without selecting anything and the measurement screen will come back.

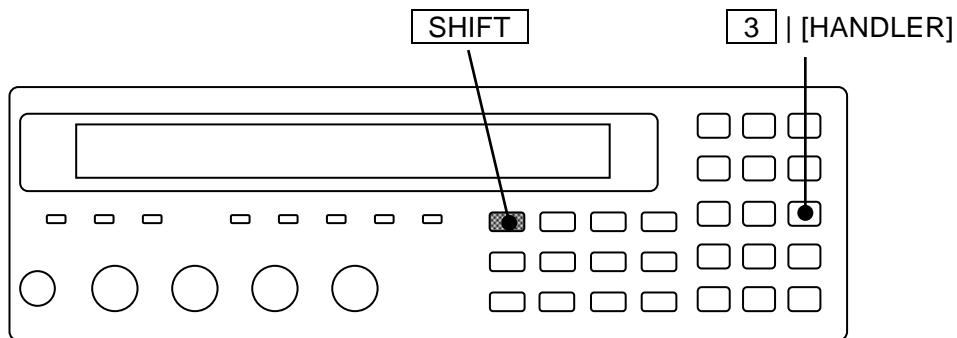

■ Setting "OUT OF BINS" output in case of S-NG

You can select whether or not S-NG (outside the range of secondary parameter) should be regarded as auxiliary BIN (AUX BIN) independent from OUT OF BINS. It is the same for limit comparison as well.

“OUT OF BINS” output setting menu is as follows:

OUT OF BINS: Include S-NG	Current setting
0)Include 1)Exclude	Options

- Include** In case of S-NG, “OUT OF BINS” signal is output in parallel. (Default value)
“Outside the range of primary parameter” and “Outside the range of secondary parameter” are not distinguished and classified as “OUT OF BINS”.
- Exclude** In case of S-NG, “OUT OF BINS” signal is not output.
When primary parameter is within the range but secondary parameter is outside the range, it should be classified as the independent AUX Bin (S-NG) instead of “OUT OF BINS”.

Select either by the numeric key.

If a setting is made or the EXIT operation is performed, one-previous menu comes back.

■ **Extending the Bin number of primary parameter**

The initial value of class number of primary parameter is “9”, but can be expanded to “14”.

Bin extension setting menu is as follows:

BIN10-14 Output: OFF 0)OFF=PHI,PLO 1)ON=BIN10-14	Current setting Options
---	----------------------------

- OFF The signals of BIN10 to BIN14 are not output (max 9-class).
 When the primary parameter is outside the range, PHI or PLO signal is output.
- ON The signals of BIN10 to BIN14 are output (max 14-class).
 Even if the primary parameter is outside the range, both PHI and PLO signal are not output.

If a setting is made or the EXIT operation is performed, one-previous menu comes back.

When signals of BIN10 to BIN14 are not output, BIN10 to BIN14 are not sorted regardless of other settings.

■ **Setting the trigger polarity**

You can select which of rising edge and falling edge of trigger signal is used to start measurement.

Polarity setting menu of trigger input signal is as follows:

TRIG Polarity:Negative 0)Negative 1)Positive	Current setting Options
---	----------------------------

- Negative Falling edge (H→L) of trigger signal is used to trigger.
- Positive Rising edge (L→H) of trigger signal is used to trigger. (Initial value)

If a setting is made or the EXIT operation is performed, one-previous menu comes back.

The Trigger polarity cannot be selected in Remote control. Also, it cannot be initialized with the *RST command or the initialize menu by the SHIFT + [INIT] key operation.

■ Setting the functions of memory selection signal

You can select the item for restoring from the setting/correction value memory specified by the input signal to the handler interface specified with /RCL0.../RCL6.

Memory selection signal setting menu is as follows:

Handler Recall Function:Setting	Current setting
0)SPOT 1)Partial >NEXT	Options (first page)
2)Setting 3)Correction 4)Both <PREV	Options (second page)

- SPOT Recalls only the spot correction value (OPEN/SHORT/LOAD). The global correction value and the setting are not recalled. (Initial value)
- Partial Recalls main settings and the spot correction value.
- Setting Recalls all settings.
- Correction Recalls all correction values. (global correction value and spot correction value).
- Both Recalls all settings and correction values.

If a setting is made or the EXIT operation is performed, one-previous menu comes back.

Recalling the less parameter, the quicker they can be changed.

To switch the correction value per channel when more than one DUT are measured by switching them with a scanner (multi-channel correction), SPOT is suitable.

When the frequency and signal level are also changed per DUT, Partial is suitable. The following settings are recalled in Partial.

- Measurement frequency
- Measurement signal level (voltage value, CV, and CC)
- Internal DC bias voltage
- Measurement range (including Auto and Rdc range)
- Trigger delay time
- Measurement speed
- Measurement parameters (type and equivalent circuit of primary parameter, and type of secondary parameter)
- Comparator function
 - Lower and upper limit of the primary parameter for limit comparison (= Lower and upper limit of BIN 1)
 - Lower and upper limit of the secondary parameter for limit comparison

When the frequency is recalled with Partial, enabled/disabled of the OPEN/SHORT/LOAD correction is retained.

Save setting values and correction values to recall in the setting/correction value memory in advance. When you try to recall them from the memory with no data saved, an error occurs.

For multi-channel correction, ZM2376 supports up to 32 channels. For channels more than 32, you can read and save the spot correction value of each channel with remote control, and then write it

back at measurement of the channel.

■ Checking the operation of handler interface

You can check the operation through outputting the given signal into handler interface or monitoring the input signal.

Handler interface test menu is as follows:

OFF ON ER	Output	Input	
TEST:OFF	Bbb Ee Mm	TRGt RCLsss VLDv LOCK	Signal monitor
0)OFF	1)ON	2)ER	Output control
	3)BIN	4)ERR	
		5)EOM	

- OFF Disables the test mode and performs usual operation. (Default value)
- ON Enables the test mode.
- ER Outputs a test signal instead of a usual signal.
Changes only /ERR to the test mode.
/ERR can be used as a general-purpose port.
However, the normal error status is not output.

The following operations work only when the test mode is enabled.

- BIN The comparison output is made into the low level one at a time.
For details, refer to “Dummy output signal” below.
- ERR Inverts /ERR.
- EOM Outputs dummy /INDEX and /EOM signals.
For details, refer to “Dummy output signal” below.

Perform the EXIT operation to return to the measurement screen.

When ON is selected, the output signal is initialized to the state when the comparator is disabled. The test signal is operated with BIN/ERR/EOM on the menu. ZM2376 ignores the input signal and operates as if nothing is connected to the handler interface. Lock by /KEY_LOCK signal is also released.

When ER is selected, only /ERR is initialized to the state when the comparator is disabled. /ERR signal is operated with ERR in the above menu. Operation of BIN and EOM are unavailable. Input signals and output signals except /ERR operate usually.

It is recommended to change the test mode while the comparator and limit comparison are disabled. When the test mode is switched from ON or ER to OFF while the comparator is enabled (the normal operation), each output returns to normal. When switched from ON to ER, the output except /ERR returns to normal in the same way.

When the test mode is set to OFF while the comparator is disabled, the output returns to normal at that time. When switched from ON to ER, the output except /ERR returns to normal at that time.

Input signal monitor

Numeric values appear while the status of Input signal line is being regarded as the negative logic input.

Signal name	Display name	Status	Descriptions of status
/TRIG	TRG	t	When Trigger polarity = Negative 0 : High level, 1 : Low level When Trigger polarity = Positive 0 : Low level, 1 : High level
/RCL0../RCL6	RCL	sss	0 .. 127 : /RCL6(MSB)../RCL0(LSB) Displays 7 bits of negative logic as 3 digits of decimal.
/RCL-VALID	VLD	v	0 : High level, 1 : Low level
/KEY_LOCK	LOC	k	0 : High level, 1 : Low level

Dummy output signal

You can control the output using numeric keys as follows.

Key	Operation	Output signal monitor
1)ON	Initializes all outputs to the status when the comparator is disabled.	B00 E0 M1
3)BIN	The comparison output is made into the low level one at a time. All are high level → /OUT OF BINS → /BIN1..→..→.. /BIN14 → /S-NG..→..All are high level	Bbb bb = 00 : OUT OF BINS, bb = 14 : BIN14, bb = 15 : S-NG, bb = 16 : All are high level
4)ERR	Inverts /ERR.	Ee e = 0 : High level e = 1 : Low level
5)EOM	Changes /INDEX and /EOM as shown in the figure below.	Mm (status of EOM) m = 0 : High level m = 1 : Low level

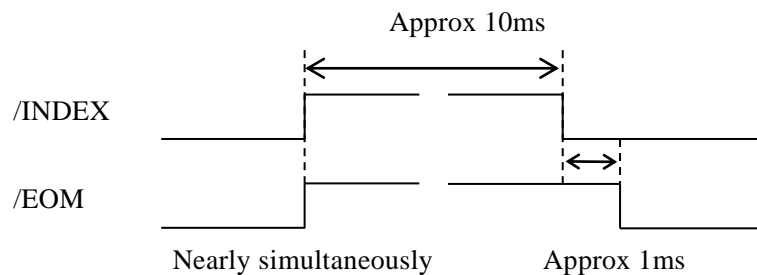
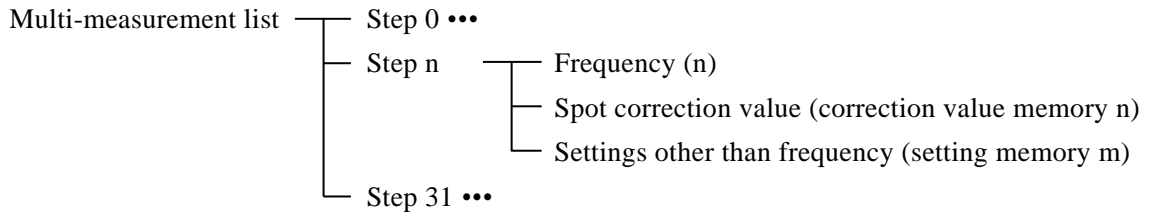

Figure 4-7 Dummy output timing

4.6 Measuring with More Than One Condition (Multi-measurement)

The multi-measurement function allows you to measure one DUT with more than one condition for comprehensive pass/fault comparison or sent these measured values to the measured data buffer collectively. When the multi-measurement is performed, register a measurement condition in each step of the multi-measurement list. Parameters other than the frequency should be saved in the setting/correction value memory.



In the multi-measurement step n, the measurement is performed at the frequency (n) which is registered in the list. Also, each spot correction value of OPEN/SHORT/LOAD is recalled from the correction value memory n. Other settings than the frequency (ex. signal level, upper and lower limits of pass/fail comparison) are recalled from a given setting memory m associated in the list.

■ Setting multi-measurement functions

SHIFT + **[LIST]**

SHIFT + **[LIST]** keys to display the multi-measurement menu.

Operation Mode

LIST:OFF	Current setting
0)OFF 1)SEQUENCE 2)STEP 3)Entry	Options

OFF	Disables the multi-measurement and returns to the normal measurement (initial value).
SEQUENCE	Enables the multi-measurement in sequence mode. Measures in all steps in the order of the list once triggered.
STEP	Enables the multi-measurement in step mode. Measure step-by-step at each trigger. It is useful to read the measurement value at each step.
Entry	Displays the multi-measurement list input menu.

If a setting is made or the EXIT operation is performed, the measurement screen comes back.

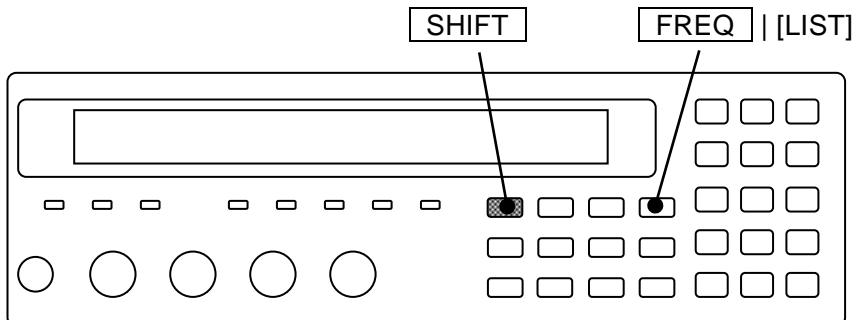

Set the frequency on the multi-measurement list input menu.

To set (/check) parameters other than the frequency, you need to save them to the setting memory (/recall from the setting memory).

Entry: Multi-measurement list input menu is as follows.

Step number	Measurement frequency	Setting memory	
LIST 31	FREQ:1.23456kHz	Memory: 31	Current setting
			Available ranges
	1mHz to 5.50000MHz	(-1/0:OFF-->)	Frequency
	0 to 31	(-1:OFF-->)	Setting memory

Initially, the cursor is placed on the measurement frequency.

Register measurement frequencies starting from step 0. Steps with a registered frequency are enabled. When you want to change measurement conditions other than the frequency in each step, register the number of the setting memory where they are registered.

The cursor can be moved between two parameters or across steps by pressing **[BS]** | **[PREV]** key or **[EXP]** | **[NEXT]** key. When an invalid step exists, the cursor cannot move to steps beyond it and cycles within valid steps.

Following shows examples of cursor movement when the **[EXP]** | **[NEXT]** key is pressed.

(STEP 0: frequency → memory) → (STEP 1: frequency → memory)
 → ... →
 → (STEP x : **OFF** → memory) → (STEP 0: frequency → memory)

(When all steps are valid)

(STEP 31: frequency → memory) → (STEP 0: frequency → memory)

Currently available range is displayed in the second line.

Perform the EXIT operation to return to one-previous menu.

When zero or a negative value is specified for the frequency, steps beyond it are disabled, and these measurement are not performed. For an invalid step, the frequency is displayed as OFF. When the step 0 is invalid, a trigger cannot cause the measurement, and an error occurs (error number -211, Trigger ignored).

When a negative value is specified for the setting memory number, recall is disabled in all steps following the current step. When the recall is disabled, the memory number is displays as OFF, and the previous settings are held in the step. When it is set to OFF, the content of the setting memory is held. When the setting memory numbers are OFF (initial value) in all steps, only the frequency is switched. When the setting memory number is specified to 0 to 31, the setting is recalled before the

measurement in the step.

■ Selectable parameters in multi-measurement

In multi-measurement, only some main settings are recalled from the setting memory.

The following settings are recalled in multi-measurement.

Signal level (voltage value, constant current value, CV, and CC)

Internal DC bias voltage

Measurement range (including Auto and Rdc range)

Trigger delay time

Measurement speed

Measurement parameters (type and equivalent circuit of primary parameter, and type of secondary parameter)

Comparator function

Lower and upper limit of the primary parameter for limit comparison (= Lower and upper limit of BIN 1)

Lower and upper limit of the secondary parameter for limit comparison

When a setting memory with no data is specified, the previous setting is held.

■ OPEN/SHORT/LOAD correction in multi-measurement

When the multi-measurement is enabled, the correction value is measured and the correction is performed at DUT measurement as follows.

• When the spot correction is disabled

The global correction value (or standard value) is measured, and the correction is performed using it.

• When the spot correction is enabled

When the correction value is measured, the frequency, main settings, and spot correction value (and standard value) are recalled for each step that is registered in the multi-measurement list, and the new spot correction value (or standard value) is measured to be saved in the correction value memory corresponding to the step. The global correction value (and standard value) on the correction value memory is held as the previous value.

When the DUT is measured, the spot correction value (and standard value) is recalled from the correction value memory corresponding to each step. The global correction value (and standard value) is not recalled. When no valid spot correction value is saved in the correction value memory, the current global correction value (and standard value) is used for correction.

Unlike usual measurement, the OPEN/SHORT/LOAD correction is not disabled in each step even when the frequency changes.

■ Operation of comparator in multi-measurement

When the multi-measurement is enabled, the limit comparison function of the primary and secondary parameters is also enabled automatically. When the multi-measurement is disabled, the limit comparison function of the primary and secondary parameters is also disabled. The limit comparison determines pass/fail based on the upper/lower limit value pair of the primary parameter (common to BIN1 for Bin sorting) and the upper/lower limit value pair of the secondary parameter.

Limit comparison ••• ☞ “4.4 Sorting the Part (Comparator)”, “4.5 Connecting to the Part handler (Handler Interface)”, and separate manual “ZM2376 Instruction Manual (Remote Control)” :CALCulate:COMPARator[:STATE] Command

In the multi-measurement, the limit comparison is performed on the upper/lower limit values of the primary parameter (BIN1) and the upper/lower limit values of the secondary parameter for each step. Once the measurement has finished on every enabled step registered in the multi-measurement list, total comparison is conducted.

• Panel display

The comparison result of primary and secondary parameters is displayed for each step.

When the measurement is finished on all the steps, the total comparison result is updated.

Primary parameter comparison result ▲ : ▼ (each step)

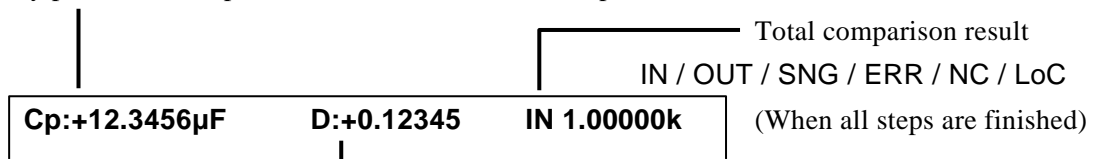

Comparison result of each step

- ▲ The measured value is larger than the upper limit or any error occurs.
- :
- ▼ The measured value is less than the lower limit value.

Total comparison result (in order of priority)

- ERR A measurement error such as signal overload or ALC error occurs.
- NC A contact failure occurs.
- LoC A Low C error occurs.
- OUT Any of primary or secondary parameters failed.
- SNG Primary parameters are all acceptable, but secondary parameters are failed.
With the initial setting, OUT is displayed instead of SNG. When you set to suppress the /OUT OF BINS output in case of the /S-NG output, SNG is displayed as a priority.
- IN All measured values are passed.

- Handler interface output

The following signals are output from the handler interface in the multi-measurement.

When the measurement is finished on all the steps, the total comparison signal (/IN, /OUT OF BIN, /S-NG, /NC, /ERR) is updated. The total comparison signal is not updated in midway steps.

Table 4-5 Handler interface output in the multi-measurement

Pin No.	Signal name	Description
30	/P-HI	Primary parameter comparison signal (updated in each step)
6	/P-IN	
31	/P-LO	
7	/S-HI	Secondary parameter comparison signal (updated in each step)
32	/S-IN	
8	/S-LO	
33	/IN	Total pass comparison signal Indicates that all measurement is normal, and all measurement values in the primary and secondary parameters are passed. In the last step, the total comparison signal is updated simultaneously with the primary and secondary parameter comparison signals.
35	/EOS (/BIN11)	Sequence completion signal Output simultaneously with the total comparison signal after the measurement is finished in all steps. In the multi-measurement, the limit comparison function is enabled, and the /BIN11 signal for bin sorting is not used. The /EOS signal is output instead.
11	/NC	Total contact failure signal In the process of multi-measurement, a contact failure or Low C failure occurs.
37	/OUT OF BINS	Total fail comparison signal Invert signal of /IN. You can set to suppress the /OUT OF BINS output at the /S-NG output. ••  OUT OF BINS Output setting menu
13	/INDEX	Signal acquisition end signal In the sequence mode, this signal is output when the signal acquisition ends in all steps and the DUT can be replaced. In the step mode, it is output when the signal acquisition ends in each step.
38	/EOM	End of measurement signal In the sequence mode, this signal is output when the measurement ends in all steps and the total comparison signal is updated. In the step mode, it is output when the comparison signal is updated in each step.
14	/ERR	Total measurement error signal Any error occurs in the process of multi-measurement.
39	/S-NG	Total secondary parameter fail comparison signal All measurement is normal, primary parameters are passed, but any of secondary parameters is failed.

The other output signals are fixed to the high level.

Input signal is always enabled with or without multi-measurement.

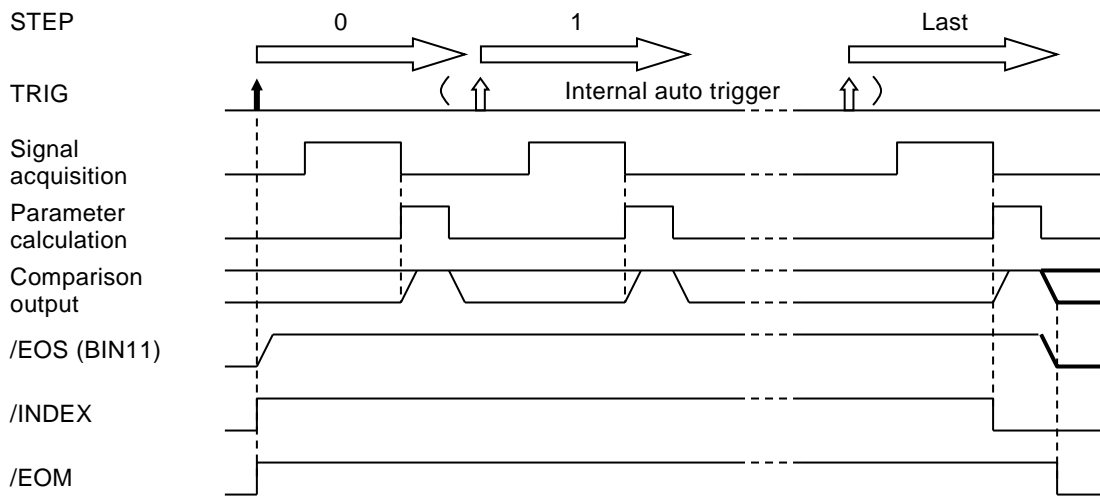

a) Sequence mode

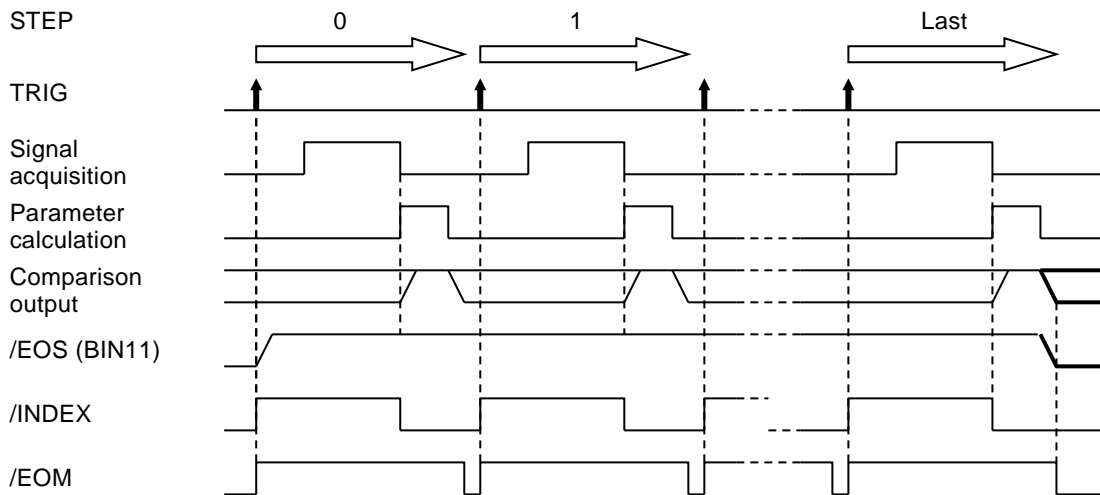

b) Step mode

Figure 4-8 Handler interface operation timing in the multi-measurement

In the step mode, the DUT can be changed per step. For example, you can measure components of a composite part with conditions suitable for each of them in sequence.

- Remarks

- 1) Triggered drive

When the triggered drive is enabled, the drive signal is output only while the /INDEX signal is H (high level).

- 2) Trigger delay time

In each step, the signal acquisition starts at the trigger delay time after the setting and correction value are recalled.

- 3) Contact check

The contact check and low capacitance check are performed in each step.

4.7 Changing the Contents Displayed on the Second Line (Auxiliary Display)

Normally the specified setting information is displayed on the second line (Auxiliary display) of measurement screen.

It is possible to change those contents into other setting information or voltage/current monitor values.

AUX DISP

Press the **AUX DISP** key to display the auxiliary display selection menu.

Aux Display:Status					Current setting
0)Status	1)Pri-Limit	2)Sec-Limit	>NEXT		Options (first page)
3)P-S REF	4)I-V	5)Z-θ	6)List	<PREV	Options (second page)

Status	Measurement condition (initial value)	A100kΩ FAST100 Int OpShLd1m . . .	ex.
Pri- Limit	Lower and upper limit values of primary parameter (specified Bin)	10:+970.000nF to +1.03000μF . . .	ex.
	The Bin number input menu is displayed. Specify the Bin number there.		
Sec-Limit	Lower and upper limit values of secondary parameter	Sec+0.00000 to +12.0000m . . .	ex.
	Even if Pri-Limit and Sec-Limit are selected, the status appears when comparator and limit comparison are disabled.		
P-S REF	Reference value for primary/secondary parameter deviation display	REF:P+1.00000μF S+100.000m . . .	ex.
	Even if P-S REF is selected, the status appears when the deviation display and deviation comparison are disabled.		
I-V	Current/voltage monitor value	Im:+123.456mA Vm:+1002.34mV . . .	ex.
Z-θ	Impedance measured value	Z:+123.456kΩ θ:+ 1.567° . . .	ex.

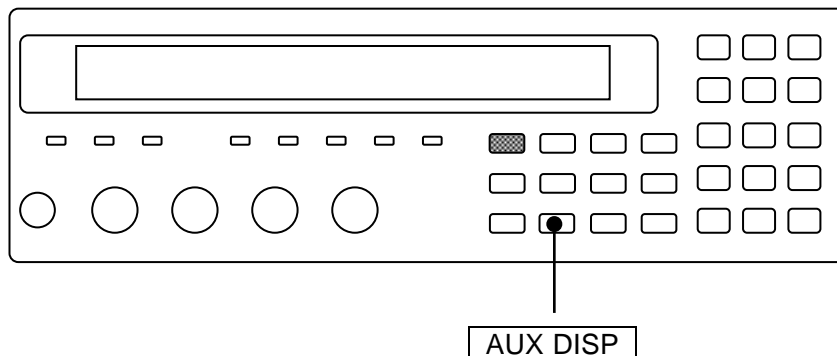

List Steps during multi-measurement

Step: 12	• • •
-----------------	-------

ex.

Even if List is selected, the status appears when the multi-measurement is disabled.

If a setting is made or the EXIT operation is performed, the measurement screen comes back.

Bin number input menu is as follows.

BIN No:14
1 to 14

Current setting
Available value ranges

To display the upper/lower limit values of primary parameter, set the Bin number.

Perform the EXIT operation to return to one-previous menu.

After setting, measurement screen comes back.

4.8 Saving/Recalling the Setting and Correction Value

ZM2376 saves/recalls the setting and correction value up to 32-set.

■ Saving the setting and correction value into the memory

SHIFT + [**SAVE**]

Press the **SHIFT** + [SAVE] keys to display the setting/correction value memory saving setting menu.

SAVE : Setting	Current settable
0 to 31 .)Correction -)Both	Available ranges

Enter the item to be saved and the memory number, and press the **ENTR** key, to carry out saving (overwriting).

After saving, the following confirmation message appears for a short time and measurement screen comes back.

Save -> 9	Example
---------------------	---------

■ Recalling the setting and correction value saved in memory

SHIFT + [**RECALL**]

Press the **SHIFT** + [RECALL] keys to display the setting/correction value memory recall setting menu.

RECALL : Setting	Current settable
0 to 31 .)Correction -)Both	Available ranges

Enter the item to be recalled and the memory number, and press the **ENTR** key, to carry out recalling.

After recalling, the following confirmation message appears for a short time and measurement screen comes back.

Recall <- 9	Example
-----------------------	---------

It is invalid to recall the setting/correction value memory, which is not being saved.

Recall <- EMPTY

The item for Save/Recall is setting (only setting) at first. Therefore, if you enter the memory number and press the **ENTR** key, only the setting can be saved or recalled.

You can temporarily change the item to Correction (only correction value) or Both by entering the decimal point **.** or negative sign **-**.

RECALL : Correction

Correction value only

Perform EXIT operation without performing saving or calling, and the measurement screen will come back.

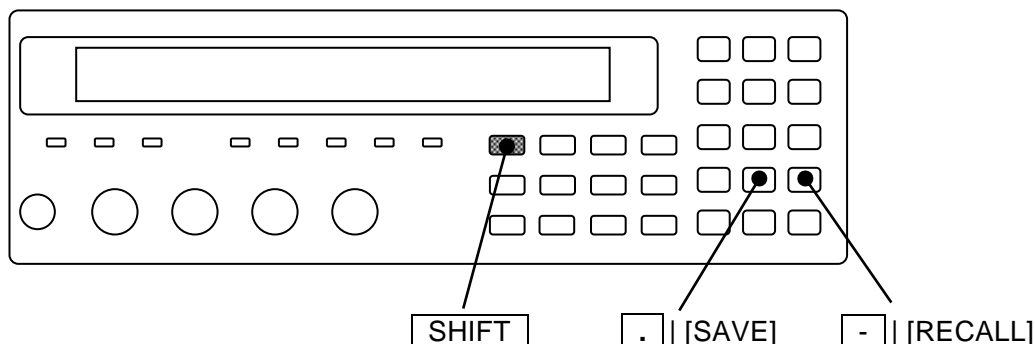

Examples of specifying

Setting (Setting only)

ex.) **2** **1**

Input the numeric value only

Correction (Correction value only)

ex.) **.** **2** **1**

Input the decimal point before numeric value

Both (Both setting and correction value)

ex.) **-** **2** **1**

Input the negative sign before numeric value.

Before entering the **ENTR** key, you can change the item for Save/Recall by entering the decimal point **.** or negative sign **-**. For example, press the **.** key to change the item to Correction, and then press the **-** key to change it to Both. Meanwhile, when the item is Correction, press the **.** key to change the item back to Setting.

After performing Save/ Recall, the item for Save/ Recall turns back to the setting.

The load standard value is treated as a set with the corresponding load correction value.

■ Initializing the setting/correction value memory

The contents of setting/correction value memory cannot be initialized by the **SHIFT** + **[INIT]** and **1** key.

It is possible to initialize the setting/correction value memory by the operation of “Fully initialization” in system setting menu. However, the setting of interface is also initialized.

Fully initialization ⇨ “4.14 Initializing of All Settings”.

4.9 Setting the Contact Check

ZM2376 provides the contact check function which can check the contact condition with DUT. To avoid a wrong measurement due to contact failure, set the contact check to “enabled”.

ZM2376 also provides the low capacitance check function to detect an abnormal low capacitance caused by a contact failure, independently of the contact check function described above.

The contact check and low capacitance check provided by ZM2376 do not give an additional error to measured values. An additional time to the measurement can be ignored.

SHIFT + **[CONTACT]**

Press the **SHIFT** + **[CONTACT]** keys to display the contact check setting menu.

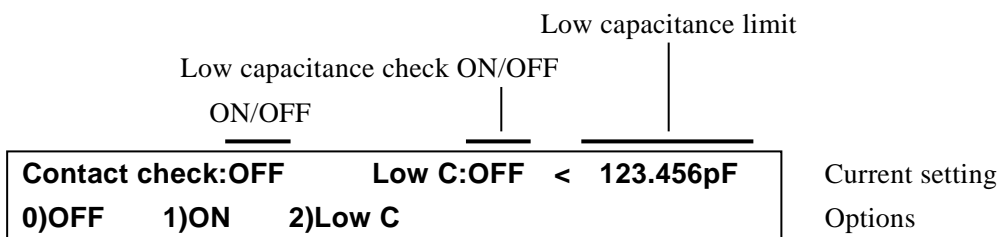

- OFF Disables the contact check (initial value).
- ON Enables the contact check.
- Low C Display the low capacitance check setting menu.

If a setting is made or the EXIT operation is performed, the measurement screen comes back.

CONTACT CHECK lamp

When the contact check or low capacitance check is enabled, CONTACT CHECK lamp lights up.

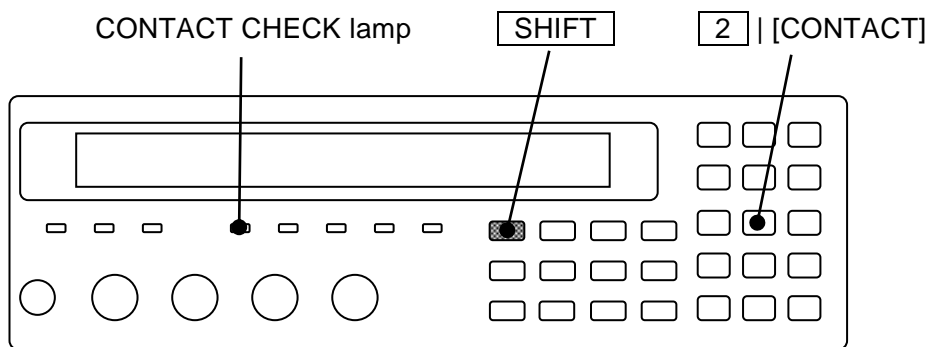

When the measured value is NC, refer to the following document for corrective actions:

- ☞ NC section in “5.1.4 Measured Value Display in Case of Error”

■ Operational outline of contact check

The contact check of ZM2376 is a simple type which detects mainly a contact failure of H_{CUR} terminal in 4-terminal connection.

The contact check of ZM2376 can be used in the following ranges.

- Measurement frequency 1mHz ~ 1MHz
- Measurement signal level 100mV ~ 5V
- Cable length 0m, 1m, 2m

The contact check should be disabled outside this range.

When a contact failure is detected:

- Panel display
The measured value is displayed as NC.
- Comparator
Failed.
(OUT OF BINS for Bin sorting, or P-HI and S-HI for limit comparison)
- Handler interface
/NC signal is at low level when the comparator function is enabled.
- Measured value output in the remote control
The measured value is becomes as error value 9.9E+37.
The measurement status is becomes as 2, which indicates a contact failure.

ZM2376 checks the relation between drive signal and measured values of voltage, current and impedance of DUT when obtaining the measured results of AC impedance. If there is incoherence, it is regarded as contact failure (NC).

In the DC resistance R_{dc} measurement, a contact failure cannot be detected.

In 2-terminal connection, the contact check does not work. Use the low capacitance check.

■ Detecting abnormal low capacitance

When a low capacitance is measured due to a contact failure, it is regarded as Low C (abnormal low capacitance) in ZM2376. Exactly, it is regarded as Low C when an impedance higher than the impedance corresponding to the specified capacitance is detected.

Low C: Low capacitance check setting menu is as follows.

ON/OFF	Low capacitance limit	
Low C check:OFF	Cth:123.456pF	Current setting Options
0)OFF 1)ON 2)Cth		

- OFF Disables the low capacitance check (initial value).
- ON Enables the low capacitance check.
- Cth Displays the low capacitance limit setting menu.

If a setting is made or the EXIT operation is performed, the measurement screen comes back.

Cth: Low capacitance limit setting menu is as follows.

C threshold: 12.3456 pF	Current setting Available value ranges
0.0000p to 999.999n	

Set the upper limit value of capacitance that should be regarded as abnormal.
When it is set to zero (initial value), the low capacitance check is not conducted even if it is enabled.

If a setting is made or the EXIT operation is performed, one-previous menu comes back.

If the low capacitance check acquires a measured value of impedance higher than 100 times of the upper limit of the recommended range for the measurement range (except the highest measurement range used in the current measurement frequency), it is regarded as Low C regardless of the low capacitance limit.

When it is regarded as Low C:

- Panel display

LoC status is displayed whether or not the comparator function is enabled/disabled.

Cp:+0.23456pF	D:+0.12345	LoC	1.0000k
----------------------	-------------------	------------	----------------

- Comparator

The comparison is conducted as usual on the assumption that the measured value can be obtained.

- Handler interface

/NC signal is at low level when the comparator function is enabled.

- Measured value output in the remote control

The measured value is output as usual. It is never an error value.

The measurement status is displayed as 2, which indicates a contact failure.

4.10 Applying the DC Bias Voltage

ZM2376 allows the measurement where DC bias voltage up to 5V is applied on polar capacitance, PN junction of semiconductor and etc. It is also possible to compensate the electromotive force of battery to measure the impedance. It cannot be ON when the secondary parameter is DC resistance Rdc.

BIAS

Press the **BIAS** key to display the DC bias setting menu.

Output status	Auto mode	Bias voltage	
DC BIAS: OFF	AUTO	1.500V	Current setting
0)OFF 1)ON	2)AUTO 3)TRACK	4)DC Volt	Options

- OFF** Turns off (0V) the DC bias output.
The set value of DC bias voltage is retained inside.
The auto DC balance and auto DC cancel functions are disabled.
- ON** Turns on (preset voltage) the DC bias output.
The auto DC balance and auto DC cancel functions are disabled.
- AUTO** Turns on the DC bias output and enables the auto DC balance function and the auto DC cancel function.
This function is mainly used to measure the impedance of the battery.
The measurement range is restricted to 100Ω or less.
- TRACK** Turns on the DC bias output and enables the auto DC cancel function. The auto DC balance function is disabled.
This function is mainly used to measure DUT with a leak current.
- DC Volt** Display the DC bias voltage input menu.

Press the ON/OFF or perform EXIT operation, and the measurement screen comes back.

BIAS ON lamp

The BIAS ON lamp of front panel lights up during DC bias output ON.

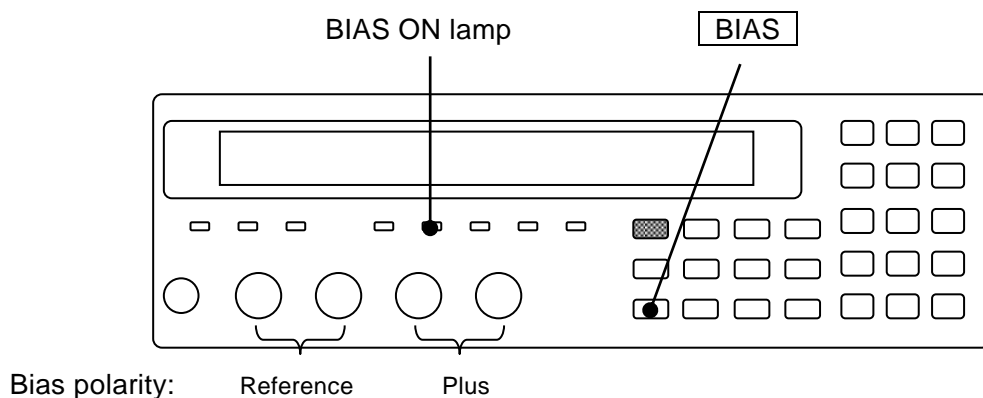

DC volt: DC bias voltage input menu is as follows

BIAS Voltage: 0.000V
0.000V to 5.000V

Current setting
Available ranges

It is possible to set at 1mV in resolution. Enter the numeric value, and press the **ENTR** key.
If a setting is made or the EXIT operation is performed, one-previous menu comes back.

The set value of current DC Bias voltage appears on the second line of measurement screen.

• • • • •	1.500	1.00 V
	BIAS	Vdc

■ Restriction between signal level and bias voltage

The peak voltage that can be output by ZM2376 is approx 7.07V.

It is impossible to set when the total of the peak value of AC measurement signal and DC bias voltage exceeds the above voltage.

If you intend to set the measurement signal level or DC bias voltage beyond the above limit, it will be set as the permissible maximum value at that moment. When the measurement signal level is 5Vrms, the bias voltage is restricted to 0V. When the DC bias voltage is 5V, the measurement signal level is restricted to approx 1.4Vrms.

■ Restriction on charge-discharging current due to DC bias

The peak current that can be output from the H_{CUR} terminal by ZM2376 is approx 280mA.

When the total of the peak value of AC measurement signal and the charge-discharging current or leak current of the DC bias exceeds this current substantially, it causes overload and cannot be measured correctly.

When the bias voltage is changed substantially while the output impedance is low, a high charge-discharging current flows. When the measurement signal level exceeds the peak current, the bias voltage decreases.

■ Settling time for DC bias voltage

The charge-discharging current at early stage of discharge/charge can be suppressed up to approx 1.4-time that of the max sensing current I_p [Arms] that can be absorbed by the current sensing section in each measurement range. Therefore, the settling time T_s [s], which is determined by the above current value, capacitance C (F) of DUT and change V_c [V] in Bias voltage, is needed until it can be within the limited current range.

$$T_s \cong C \times V_c / (I_p \times 1.4)$$

Max sensing current that can be absorbed by the current sensing section

☞ “Table 3-3 Max. current, max. voltage and output impedance in each measurement range”

However, the measurement range (max sensing current) changes depending of the measurement frequency.

When the charge-discharging current exceeds this value, since the current beyond the value runs

through the protection circuit of L_{CUR}/L_{POT} terminal, it is possible that the actual settling time can be less than T_S .

When the current enters the limited current range during charging/discharging, it will converge for the settling time $T_{stl}[s]$, which is determined by the output impedance $R_d[\Omega]$ and capacitance $C[F]$ of DUT.

$$T_{stl}[s] \cong 7.13 \times C \times R_d .$$

■ **Actions when there is a leak current or it takes time for charge/discharging**

When the leak current is large due to a low insulation resistance of DUT, when the charging current runs for a long time due to the dielectrics absorbing, or when charging takes a long time due to a large capacitance, the measurement may be impossible by the following reasons:

- DC cancel becomes insufficient due to a leak current and output impedance to cause the voltage sensing section to saturate.
- The peak value of the signal current exceeds the permissible range of measurement range.
- Auto selection of measurement range does not work properly.

Even in these situations, the measurement may be possible as follows.

- **Hold the measurement range to the range accepting measurement range.**
Try changing the measurement range once.
However, it is afraid that the measurement accuracy may go down while exceeding the recommended measurement range.
- **Increase the measurement signal level**
Permissible range of the voltage and current measurement increases.
- **In the DC bias setting menu, select TRACK**
Since DC cancel amount is adjusted following variation of the bias voltage actually applied to the DUT, the voltage sensing section becomes less likely to saturate when measuring low impedance. However, the current sensing section may saturate due to a leak current. When the current sensing section saturates, adjust with the measurement range and measurement signal level as described above.

ZM2376 fine adjusts the DC cancel amount at the voltage sensing section in the range of the DC bias voltage $\pm 0.25V$ when the auto DC cancel function is enabled. However, it takes time to adjust. When the auto DC cancel function is disabled, the cancel amount is equal to the set value of the bias voltage.

■ Measure the battery internal impedance

It is possible to directly measure the impedance of a battery with electromotive force 5V or lower in the following procedure. However it assumes a chemical battery that can be charged in some degree.

- Set the signal level in the following recommended range.

When the output impedance is 100Ω 100mVrms to 5Vrms

When the output impedance is 25Ω 200mVrms to 5Vrms

When the output impedance is 6Ω 501mVrms to 1.2Vrms

(this may be limited by other settings)

Considering the electromotive force, the upper limit is $(5 - \text{max value of electromotive force[Vdc]} / 1.414)$ [Vrms].

Outside the above ranges, the auto DC balance function may not work properly.

To use the whole range of DC bias voltage, this should be 1.46Vrms or less.

- Measure the electromotive force of the battery with a separately prepared DC voltmeter.
- Set the DC bias voltage of ZM2376 to the measured electromotive force.
- Connect the battery to ZM2376 with an adequate jig.

By matching the DC bias voltage and electromotive force exactly, you can prevent the current sensing section from saturating with the DC current or the voltage sensing section from saturating with the unbalanced voltage.

If it is difficult to match them exactly, the following setting makes the measurement easier.

- In the DC bias setting menu, select AUTO.

ZM2376 fine adjusts the DC bias voltage in the range of the set value $\pm 0.25V$ so that the DC current at the L_{CUR} terminal is approx zero when the auto DC balance function is enabled. However, the measurement range is restricted to 100Ω or less. Therefore, the upper limit of impedance for correct measurement is approx $2k\Omega$. Also, it takes time to operate the auto DC balance, and it accompanies some charging/discharging.

WARNING

- Be sure to match the DC bias voltage with the actual electromotive force of a battery.
Do not use the nominal value or estimated value. Measure the actual voltage.
- Do not connect in reversed polarity.
Be sure to check the polarity before connecting a battery.

If the above precautions are not observed, the battery may burst or cause fire due to overcharge or over discharge.

⚠ WARNING

- If an error message "DC Bias unbalance" is displayed
Remove the battery immediately and check the polarity and electromotive force.
-

⚠ CAUTION

This message is displayed instead of the measured value when the auto balance failed. When the measurement failed, check the polarity and electromotive force of the battery. When leaving the actual electromotive force and the DC bias voltage differ significantly, a large current may continue flowing to deteriorate ZM2376 and the battery.

As with the battery, a charged EDLC (Electric double layer capacitor) with big capacity can be measured.

When the internal resistance is significantly high, the auto DC balance may not work properly. In this case, disable the auto DC balance function and adjust the DC bias voltage manually.

When many batteries are measured with a higher measurement speed, disable the auto DC balance function and match the DC bias voltage and electromotive force as exactly as possible. If an exact match is difficult, take the following actions.

- Increase the measurement signal level.
This increases the margin to the unbalanced voltage.
However, the available max electromotive force (= DC bias voltage) is restricted.
- Make the output impedance 25Ω or more.
This can decrease the charge-discharging current compared to 6Ω.
Note that the variation may become large when measuring low impedance.
- Fix to a measurement range for a larger current.
However, the measurement accuracy becomes lower.
- Enables the auto DC cancel function.
It makes low impedance easier to measure.
Although the measurement becomes slow, it can save time for the auto DC balance.

For a battery whose electromotive force exceeds 5V, measure it in the same way as “Figure 4-9 Example of external voltage bias circuit”. Usually, DC blocking capacitors C1 and C2 are charged from the battery, external voltage source is not needed. If you do not want to take off the load current from the battery or you want to save charge-/discharging time, charge C1 and C2 to the electromotive force of the battery by an external voltage source in advance. You can reduce the load of the battery by removing the external voltage source or increasing the resistance value R1 for

charge-/discharging.

■ Applying the high DC bias voltage

To apply the high bias voltage beyond 5V onto the DUT, external voltage source is required. In this case, insert the capacitance in series between H_{CUR} terminal and H_{POT} terminal so that the DC voltage and current may not run through the LCR meter.

Set the DC bias output of ZM2376 to OFF.

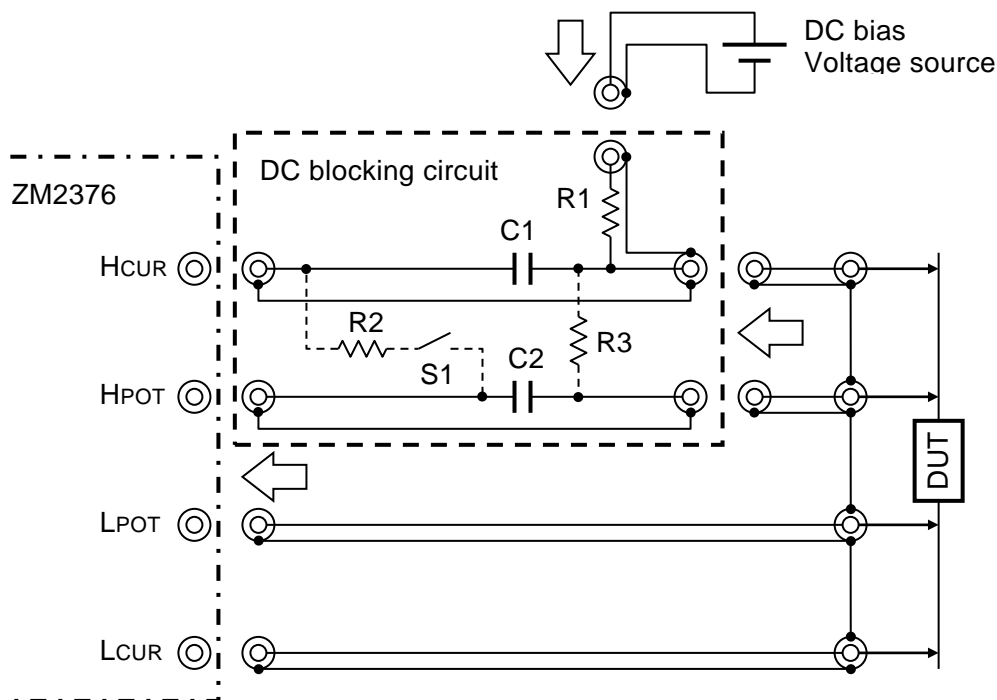

Element value: Example when frequency is 100Hz or more and minimum output impedance is 25 Ω .

C1 = 200 μ F (Bipolar electrolytic capacitor)

C2 = 2.2 μ F (Film capacitor)

R1 = 1k Ω (R2=1k Ω , R3=1M Ω)

Figure 4-9 Example of external voltage bias circuit

- C1 When the minimum output impedance is 100 Ω or the measurement is not performed at low frequency, the charge-/discharging time can be shortened by decreasing C1. When the measurement is performed at lower frequency or you want to decrease the measurement error at low impedance, increase C1.
- C2 As with C1, select an optimum value depending on the frequency and so on. An additional error of the phase increases at lower frequency. To reduce this error, increase C2. However, it takes a longer settling time of the signal.
- R1 R1 provides the charge-discharging current. R1 should be set to the value excessively higher than the parallel value between the output impedance of LCR meter and the impedance of DUT. Otherwise, the signal level applied to the DUT decreases, thereby resulting in a large measurement error. In case of measurement of a large capacitance

whose impedance is lower than output impedance of the LCR meter, the charge-/discharging time of DUT can be shortened by decreasing R1.

- S1, R2 When you greatly change the bias voltage while the DUT is being connected: if the switch S1 is closed temporarily, the charge-/discharging time of C2 can be shortened. When charge-/discharging almost finishes, open S1 to avoid an additional error caused by R2 and wait settling of the signal before the measurement.
- R3 If you need the C2 to be remained in charged state while the DUT is not being mounted, provide R3.

At a low or high frequency, an additional error that cannot be correct with OPEN and SHORT correction is often distinguishable. In these situations, perform the LOAD correction if necessary. By setting the bias voltage to 0 V and measuring a resistor of approx 100Ω with a good frequency response, you can check an approx additional error.

If a change occurs in the bias voltage, the charge-discharging current of the DUT runs through the L_{CUR} terminal of the LCR meter, and the current sensing circuit of the LCR meter temporarily saturates to disable the measurement. Also, the change of the bias voltage is applied to the H_{POT} terminal through C2, and the voltage sensing circuit of the LCR meter temporarily saturates to disable the measurement.

WARNING

Use the bias voltage within the following range:

$$(|\text{Bias voltage[V]}| + 1.41 \times \text{Measurement signal level[Vrms]}) < 42[\text{V}]$$

Otherwise, it may cause an electric shock.

4.11 Applying the DC Bias Current

To flow the DC bias current in the inductor for measurement, you need a choke coil to reduce an influence of the external power supply connected with DUT in parallel in addition to a DC blocking circuit for applying the bias voltage and an external power to provide the bias current. Typical measurement system is as follows.

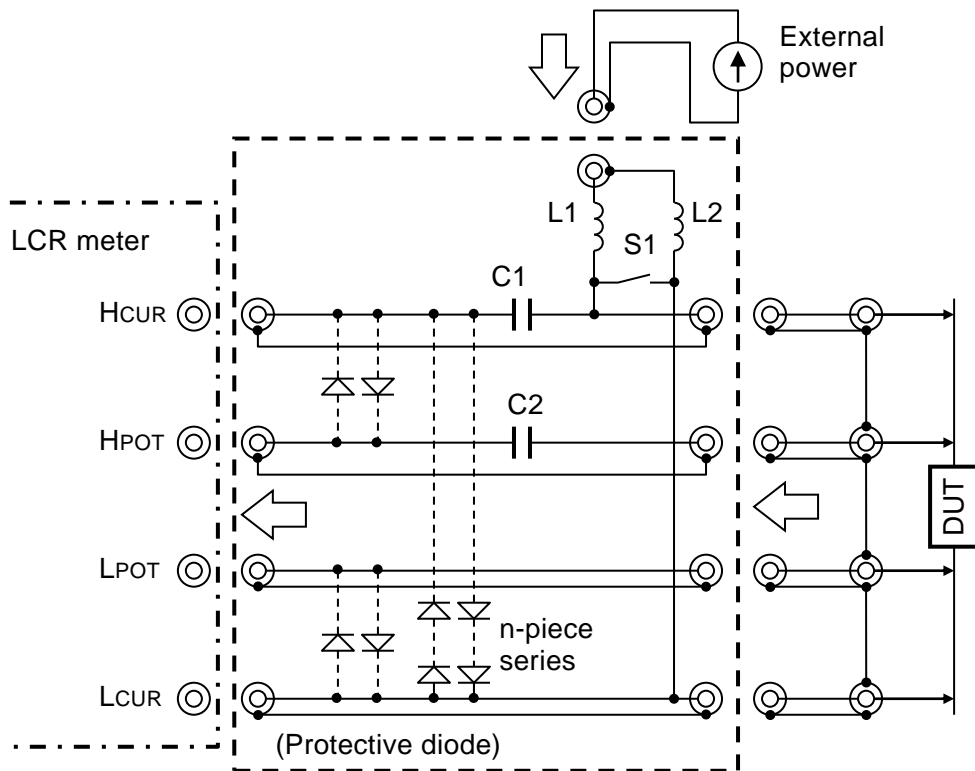

Element value: Example when the measurement frequency is 1kHz or more.

C1=20 μ F (Film capacitor)

C2 = 1 μ F (Film capacitor)

Figure 4-10 Example of external current bias circuit

Usually, since the OPEN correction cannot be performed to remove an influence caused by the bias current source, set the impedance of the choke coil L1 + L2 excessively larger than the impedance of the DUT to reduce the measurement error.

The external power must be isolated from the ground. When the stray capacitance to grounding is large, the measurement error may increase or the LCR meter may be unstable to disable the measurement.

It is safe to lower the bias current to zero slowly and close the switch S1 before connecting/disconnecting the DUT. The LCR meter may be damaged due to a high voltage caused by the disconnected DUT. Set the protective diode. The rectifier diode, which has a surge current susceptibility for preventing from damaging due to the bias current and also has a small reverse leak

current, is suitable. When the signal voltage at the DUT end is $1V_{rms}$ max, the number of series between H and L should be approx 8 pieces. Keep the forward voltage not to conduct the diode by the measure signal

 **WARNING**

The bias current should be increased/decreased little by little. If it is changed rapidly, a high voltage may be generated, thereby causing an electric shock or damaging the LCR meter.

To connect/disconnect the DUT, the bias voltage should be set to zero first. The DUT should be connected firmly by tightening with screws or soldering. Once the inductor is disconnected while the bias current is running, a high voltage may be generated, thereby causing an electric shock or damaging the LCR meter.

If the temperature of DUT can be increased during measurement, do not touch it until the temperature excessively drops after measurement. If high voltage or current is applied on the DUT for a long time, high temperature may cause a burn.

 **CAUTION**

The bias current should be increased/decreased little by little. If it is changed rapidly, a high voltage may be generated, thereby causing an electric shock or damaging the LCR meter.

To connect/disconnect the DUT, the bias voltage should be set to zero first. The DUT should be connected firmly by tightening with screws or soldering. Once the inductor is disconnected while the bias current is running, a high voltage may be generated, thereby causing an electric shock or damaging the LCR meter.

If the temperature of DUT can be increased during measurement, do not touch it until the temperature excessively drops after measurement. If high voltage or current is applied on the DUT for a long time, high temperature may cause DUT/ circumference can be burn out.

Usually, a constant voltage/current power supply (CVCC) is used for an external power. Set the output voltage to minimum necessary value so that it is safe even if the output terminal is released. When the power supply operates unstably, you can adjust the response characteristics of the power supply or insert a register in series to stabilize it.

When an external power is connected, measured values may vary by noise mixing like ripple current. Also, the capacitance to grounding may increase (the impedance to grounding decreases), and the measurement error increases or the operation is unstable to disable the measurement. In these

situations, consider the following measures.

- Use an external power with low noise.
- Connect a bypass capacitor between power supply terminals to absorb the ripple current.
- Separate the ripple frequency of the external power and the measured frequency.
- Insert a choke coil to the LOW side to restrict noise mixing and decrease of the impedance to grounding. When the common mode noise is high, it may be improved by reversing the polarity of the power.
- Fix to a measurement range not prone to cause a measurement error.
- Increase the measurement signal level of the LCR meter or decrease the output impedance.
- Decrease the measurement speed and also use averaging.

4.12 Disabling the Key-Operation of Panel

The key-operation of panel can be disabled.

■ Disabling/enabling the key-operation through the front panel

SHIFT + [**KEY LOCK**]

Press the **SHIFT** + [**KEY LOCK**] keys allows alternately switching between disabling (lock) and enabling (unlock) for key-operation.

However, even if key-operation is disabled, only the following functions are effective:

- Enabling function for the key-operation with the **SHIFT** + [**KEY LOCK**] keys.
- Restoring function from Remote into Local (panel operation) with the **LOCAL** key.

KEY LOCK lamp

The KEY LOCK lamp of front panel lights up while the key-operation is being disabling.

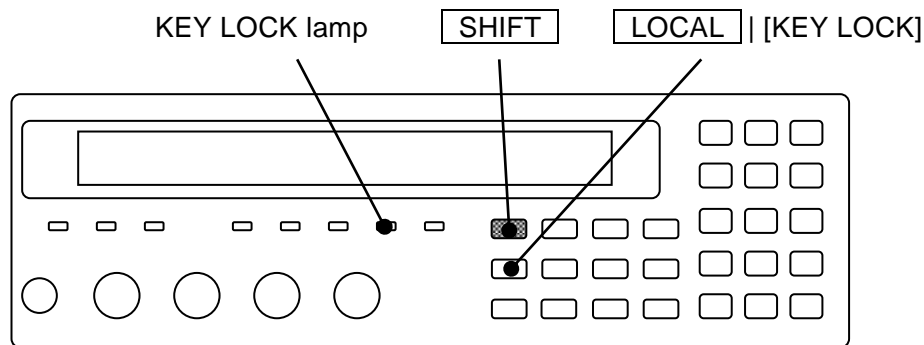

■ Disabling the key-operation through the Handler interface

If /KEY_LOCK signal of handler interface is set to “1” (low level), the key-operation of panel can be disabled for that period. The /KEY_LOCK signal is disabling all key-operation. Also in this case, the KEY LOCK lamp lights up.

Locking by the /KEY_LOCK signal cannot be canceled by the panel operation or remote control interface. Only when the /KEY_LOCK signal is set to “0” (high level), it can be canceled.

4.13 Changing the Settling Wait Time During Automatic Adjustment

Auto adjustment operations like the auto range selection perform more than one measurement by changing the setting during adjustment. Settling wait time for the next measurement after the setting is changed is set to 20ms (default value). It does not need to be changed.

Under actual operating conditions, you can change it, for example, if you want to shorten the time for auto adjustment as the settlement is quick or if you want to make the settling wait time longer because auto adjust do not operate correctly by a longer settlement.

SHIFT + [**SYSTEM**]

Press the **SHIFT** + [SYSTEM] keys to display the system setting menu.

SYSTEM setting		
0)INTERFACE 1)BEEPER	>NEXT	Options (first page)
2)INITIALIZE ALL 3)SETTLING	<>	Options (second page)
4)SELF TEST 5)VERSION	<PREV	Options (third page)

Press the **3** key to select the SETTLING, and the settling wait time setting menu is displayed.

SETTLING : 20ms	Current setting
1ms to 99ms	Available value ranges

Enter the numeric value and use the **ENTR** key or the exponential part input **EXP** + [m] keys.

If a setting is made or the EXIT operation is performed, one-previous menu comes back.

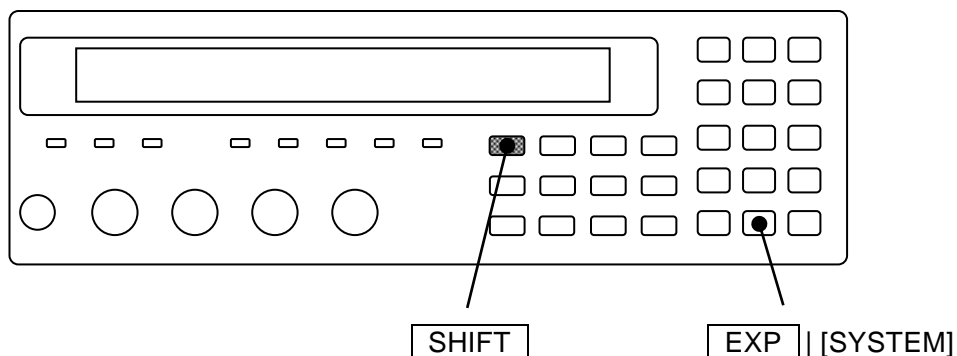

4.14 Initializing of All Settings

ZM2376 can be initialized in some levels.

- Initializing the current setting while the contents of setting/correction value memory are being left over

SHIFT + [INIT]

Press the **SHIFT** + [INIT] keys to display the initializing menu.

INITIALIZE	
1)Execute	Options
Done	Completion message

Press the **1** key and select the Execute, and the current setting and correction value return to the initial values.

After execution, the completion message appears for a short time and measurement screen comes back.

The following setting cannot be initialized but retained:

- 1) Contents of setting/correction value memory
- 2) Frequency and setting memory specified in the multi-measurement list
- 3) Setting of interface (GPIB, RS-232, USB, and LAN)
- 4) Trigger polarity of handler interface

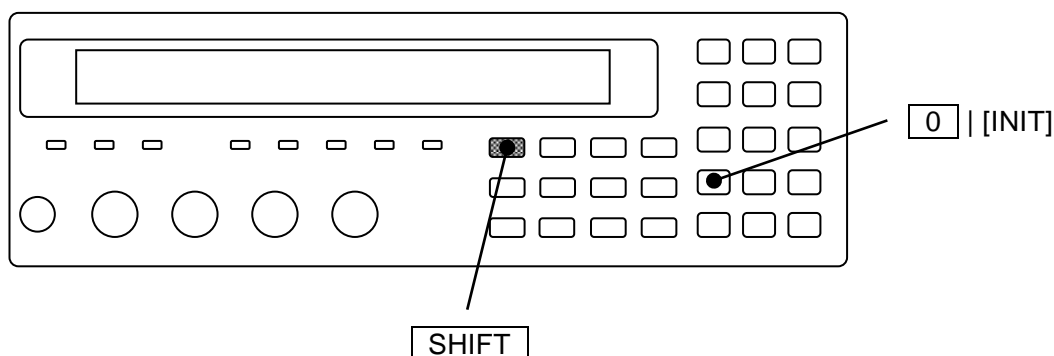

■ Fully initialization: Initializes of all settings

Fully initialization is conducted in system setting menu.

SHIFT + [**SYSTEM**]

Press the **SHIFT** + [SYSTEM] keys to display the system setting menu.

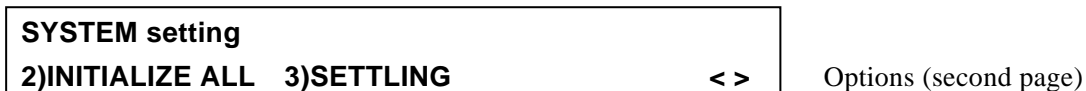

Press the **2** key to select the INITIALIZE ALL, and the following fully initialization setting menu is displayed.

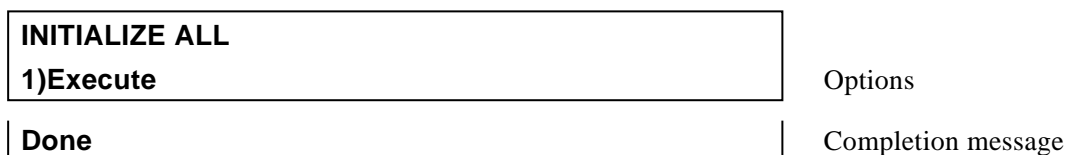

Perform the EXIT operation to return to one-previous menu.

If **1** key is pressed, following settings will return to factory default settings.

- 1) Current setting and correction value
- 2) Contents of setting/correction value memory
- 3) Contents of multi-measurement list
- 4) Setting of interface (GPIB, RS-232, USB, and LAN)
- 5) Trigger polarity of handler interface

After execution, the completion message appears for a short time and measurement screen comes back.

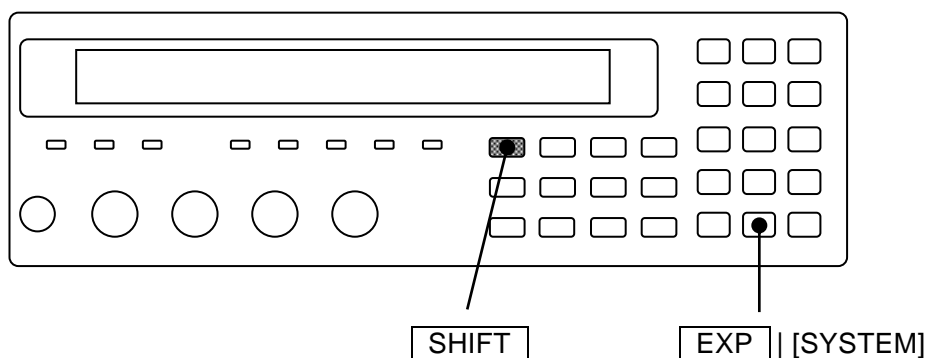

In the remote control, it is possible to initialize only 1), 2), and 3) described above.

••• the separate manual “ZM2376 Instruction Manual (Remote Control)” :SYSTem:RST command

■ Initializing the operation mode

ZM2376 provides more than one operation mode.

The operation mode cannot be initialized by the above two initializing operations.

To initialize the operation mode, set the operation mode to the default value. Set the operation mode in the following orders.

- | | | | | | |
|--------------|----------|---------------|---------------|----------|--|
| SHIFT | + | SYSTEM | key operation | → | Displays the system setting menu |
| - | 2 | 3 | 0 | 0 | → Displays the operation mode setting menu |
| 0 | key | | | | → Selects the Mode 0 (Default value) |

If the operation mode is set, same initial state as when fully initialization is executed in that mode is established. Initial setting may differ in each operation mode.

For details •••  "4.18 Switching the Operation Mode (alternative command)"

■ Completely restoring to the setting before shipment

To completely restore the factory default settings, set the operation mode to Mode 0 (default value).

Operation method •••  "Initializing the operation mode" above

4.15 Self-Diagnosis

The self-diagnosis function for analog measurement circuit is built in the ZM2376.

This function automatically runs at power-on, besides you can use it at your option.

SHIFT + [**SYSTEM**]

Press the **SHIFT** + [**SYSTEM**] keys to display the system setting menu.

SYSTEM setting 4)SELF TEST 5)VERSION < >	Options (third page)
SELF TEST 123456h Running	Maintenance data Running message
Passed	Pass message
Hardware failed	Error message example

Press the **4** key to start the self-diagnosis, and display the “Running” message.

The self-diagnosis function finishes after several seconds, and if there is no error, the “Passed” message appears for a short time and the measurement screen comes back. It is impossible to interrupt this diagnosis function.

The maintenance data on the top right shows the total time operated.

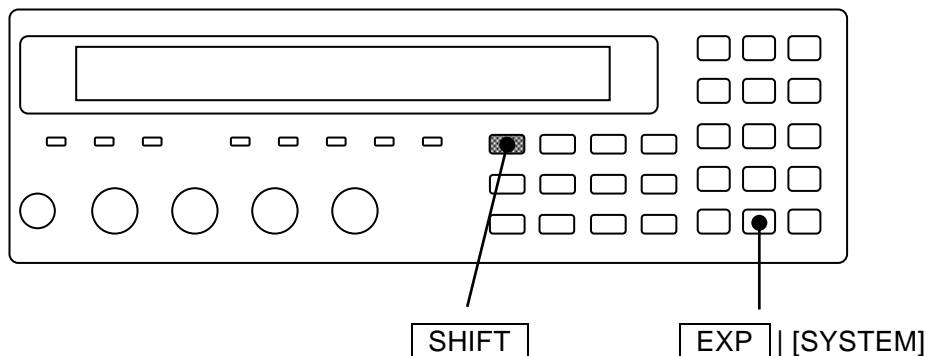

If there is an error, the following error message is displayed.

- Hardware failed Error of general measurement circuit
- Oscillator failed Error of drive signal source
- Analyzer failed Error of voltage/current measurement section
- HF failed Error of high-frequency internal impedance bridge

The serious error of measurement circuit can be detected by the self-diagnosis function. Slight error cannot be found. To enhance the reliability of measurement, we recommend you to make a periodical inspection such as starting inspection. The measurement of the DUT whose correct value was already identified enables even the slight error to be detected. To make a critical measurement, it is preferable to check before and after the measurement.

4.16 Checking the Version

The version number of ZM2376 firmware (built-in control software) is displayed after power-on. You can also check it in the system setting menu.

SHIFT + [**SYSTEM**]

Press the **SHIFT** + [SYSTEM] keys to display the system setting menu.



Press the **5** key to select VERSION to display the version of ZM2376.

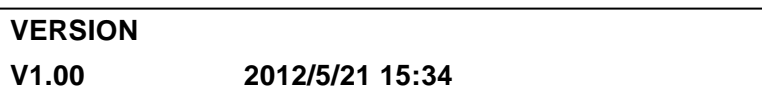

Version Last adjustment date and time (display only, and cannot be set)

This is an example indicating the display format. The displayed content is different from that of actual product.

Perform the EXIT operation to return to one-previous menu.

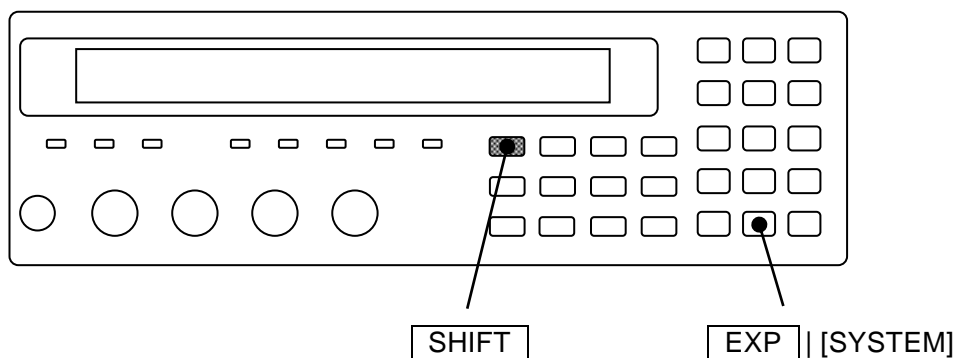

4.17 Remote Control

ZM2376 can be remotely controlled by USB or RS-232 and GPIB.

LAN is available optionally.

For more information, refer to the separate manual “ZM2376 Instruction Manual (Remote Control)”.

The separate manual is included in the attached CD-ROM.

The setting of remote control interface is made from the system setting menu.

SHIFT + [**SYSTEM**]

Press the **SHIFT** + [SYSTEM] keys to display the system setting menu.



Select INTERFACE with the **0** key to display the remote control interface setting menu.

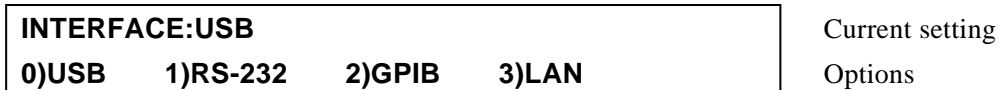

USB Selects USB (initial value) and displays the USB confirmation screen.

RS-232 Selects RS-232 and displays the RS-232 setting menu.

GPIB Selects GPIB and displays the GPIB address setting menu.

LAN Selects LAN and displays the LAN setting menu.

When the option is not furnished, this option is not displayed.

Select either one with a numeric key.

Perform the EXIT operation to return to one-previous menu.

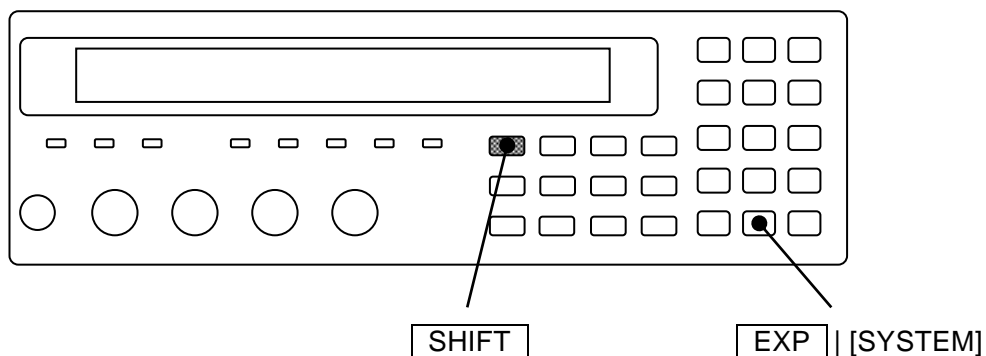

4.18 Switching the Operation Mode (alternative command)

ZM2376 can change the remote control commands by switching the operation mode.

1) Operation mode 0: Standard operation mode

Use the standard command for remote control.

The factory default setting is the operation mode 0.

The operating method and functions in the operation mode 0 are described in Chapters 3, 4, 5, and the separate manual “ZM2376 Instruction Manual (Remote Control)”.

2) Operation mode 1: Alternative command mode

Use the alternative command for remote control instead of the standard command

Use the operation mode 1 when the alternative command is easier to use for you.

The alternative command is described in the separate manual “ZM2376 Instruction Manual (Alternative Command)”.

The panel operation is the same as the operation mode 0.

The separate manual is included in the attached CD-ROM.

■ Switching of operation mode

The operation mode is switched with the system settings menu.

SHIFT + [**SYSTEM**]

Press the **SHIFT** + [SYSTEM] keys to display the system setting menu.

SYSTEM settings 0)INTERFACE 1)BEEPER	>NEXT	Options (first page)
---	-----------------	----------------------

Press the **-** **2** **3** **0** **0** keys in this order to display the operation mode setting menu as shown below. (This option is not displayed in the system menu.)

Operation mode:0 0)Mode 0 1)Mode 1	Current setting
	Options

If a setting is made or the EXIT operation is performed, the measurement screen comes back.

When the operation mode is set, the initialization equivalent to “INITIALIZE ALL” in each operation mode is executed.

When the operation mode 0 is selected, all settings are reset to the factory default. The operation mode cannot be initialized by any method other than the selection of operation mode 0.

In the operation mode 1, the underline cursor is displayed at the end of second line of the display.

Operation mode 0	<table border="1"><tr><td>• • • • • • •</td><td>1.00000k</td></tr><tr><td>• • • • • • •</td><td>1.00 V</td></tr></table>	• • • • • • •	1.00000k	• • • • • • •	1.00 V
• • • • • • •	1.00000k				
• • • • • • •	1.00 V				
Operation mode 1	<table border="1"><tr><td>• • • • • • •</td><td>1.00000k</td></tr><tr><td>• • • • • • •</td><td>1.00 <u>V</u></td></tr></table> ← Underline	• • • • • • •	1.00000k	• • • • • • •	1.00 <u>V</u>
• • • • • • •	1.00000k				
• • • • • • •	1.00 <u>V</u>				

5. TROUBLESHOOTING

5.1 Error Message	5-2
5.1.1 Errors at Power ON.....	5-3
5.1.2 Errors at Panel Operation.....	5-4
5.1.3 Errors During Measurement	5-5
5.1.4 Measured Value Display in Case of Error.....	5-6
5.2 When the Device Appears to be a Problem	5-7

5.1 Error Message

An error in the self-diagnosis at power-on or a failure in the panel operation or remote control causes an error message to be displayed.

This section describes the content, cause, and corrective action of main error messages.

The error messages related to the remote control are described in the separate manual “ZM2376 Instruction Manual (Remote Control)”.

When the repair is required, please contact NF Corporation or one of our representatives.

When you request the repair of ZM2376, please let us know the content of an error message if it is displayed. An error message not listed in this instruction manual may be displayed due to a malfunction caused by strong external noise.

Before an error message, internal status at the time when an error occurred may be displayed. When making an inquiry to NF Corporation, giving us the internal status along with the error message will be helpful to solve the problem.

<u>Warning Level:n</u>	<u>Code xxxxxxxx</u>	<u>Error Message</u>
Internal status		Usual message

A special message not listed here may be displayed, for instance, when the firmware is updated. If other documents are supplied, also refer to such documents.

5.1.1 Errors at Power ON

At power-on, the self-diagnosis is conducted and if an error is found, an error message as listed below is displayed on the initial screen.

Error Message	Content and Cause	Corrective action
ROM ERROR	Internal memory (ROM) error	Turn off the power once, and turn it on again. If the error occurs again, the device is defective, requiring the repair. If either of these errors is detected, the error message is kept displayed, and the device cannot proceed to usual operation.
RAM ERROR	Internal memory (RAM) error	
Calibration memory lost	Calibration data has been lost	
Hardware failed	Error of general measurement circuit	
Oscillator failed	Drive signal source (H _{CUR} terminal) failure	
Analyzer failed	Error of voltage/current measurement section	
HF failed	Error of high-frequency internal impedance bridge	
Previous setting lost	Settings or correction values have been lost. An error is found in the setting memory, correction value memory, or resume memory. •Defective memory •Temporary failure due to power off, etc. during data processing	Re-set the lost data. If data loss is detected, the memory is initialized and the device proceeds to usual operation. This error message can be reset by pressing any key. If this error message is displayed every time when the power is turned on, the device is defective, requiring the repair.
Configuration memory lost	System settings such as GPIB address have been lost. •Defective memory •Temporary failure due to power off, etc. during data processing	

5.1.2 Errors at Panel Operation

Main errors due to the panel operation are as listed below.

Error Message	Content and Cause	Corrective action
Settings conflict	Specified settings could not be made due to the restriction by other settings.	Use within restricted conditions. Or, change the settings that restrict others.
BIAS Over	DC bias voltage setting was limited so that it does not exceed the maximum output voltage (about 7Vpeak) because measurement signal level is large.	Reduce the signal level when large DC bias voltage is required.
LEVEL Over	Measurement signal level setting was limited so that it does not exceed the maximum output voltage (about 7Vpeak) because DC bias voltage is output.	Reduce the DC bias voltage setting or turn off the DC bias output when large measurement signal level is required.
Memory error	Contents of setting/correction value memory are lost.	Re-save the contents.

Since there are other error messages and warning messages not listed here, see the description of respective operations.

5.1.3 Errors During Measurement

Main error messages displayed during measurement or during measurement of correction values are as listed below.

Error Message	Content and Cause	Corrective action
Trigger ignored	•When trigger source is INT (internal), an attempt to apply other trigger was made and thus that trigger was ignored.	Set the trigger source correctly according to actual trigger signal.
	•Though the device does not wait for trigger, an attempt to apply the trigger was made and thus that trigger was ignored. Possible causes will be as follows: 1) During the measurement, the trigger is not accepted. 2) If *RST command is executed, continuous initiation is disabled, and thus the trigger immediately after that is not accepted.	For the operation from the panel, press the SHIFT + [INIT] keys and then the 1 key to execute initialization. For the operation from remote control, 1) Send :ABORT command to abort the measurement once. 2) Send :INIT:CONT ON command or :INIT command to place the device in trigger waiting state.
	•The device is in overheating state, and thus the trigger was ignored.	Allow time until internal temperature lowers sufficiently, and reset the error.
Correction meas failed	OPEN, SHORT, LOAD correction values could not be measured.	Perform usual measurement to check the condition where measurement failed, and then remove a problem.
Timeout error	•As the measurement impossible state lasts for a long time, the measurement was terminated forcibly. Main cause is large external noise or electrostatic discharge.	Install device or cables that generate large noise away from the LCR meter. Beware of charged device or human body so as not to discharge to the LCR meter during measurement.
Over Temperature (Tripped)	•Overheat was detected. The drive signal level becomes zero, disabling new measurement. Main causes will be as follows: 1) The impedance below 1Ω was measured for a long time at a place of high ambient temperature. 2) Cooling fan is defective.	Remove a cause of overheat, and then allow time until internal temperature lowers sufficiently, and reset the error. 1) Restrain the internal temperature by lowering the ambient temperature or executing intermittent measurement by triggered drive. 2) Please ask NF Corporation or one of our representatives for repair.
Over Temperature (Removed)	•Though overheat was detected, the temperature has already lowered at which the device can operate.	Press the ENTR [EXIT] key to reset this message and the device will be recovered to usual operation.

Other error message may be displayed according to the situations.

For warning messages displayed due to various operations, see the description of each operation.

5.1.4 Measured Value Display in Case of Error

If an error occurred in the impedance measurement, the measured values, including primary parameter, secondary parameter, voltage monitored value, current monitored value, and the impedance on the second line of the measurement screen are displayed as follows.

Display of measured value	Content and Cause	Corrective action
NC (No Contact)	<ol style="list-style-type: none"> 1) A contact failure was detected in the contact check. 2) A contact failure was detected in the low capacitance check. <p>When the contact check is enabled, the measured value may become NC due to the following causes:</p> <ol style="list-style-type: none"> 3) The damaged drive signal source (H_{CUR}) generates an abnormally small measurement signal. 4) The voltage detector or current detector is faulty. 	<p>For the cases of 1) and 2), check the connection cables and contact conditions to ensure stable connections. To avoid false detection, use the contact check in the specified range.</p> <p>For the case of 1), the measured value read by the remote control is the error value 9.9E+37.</p> <p>For the cases of 3) and 4), disable the contact check and the low capacitance check, and then use the voltage/current monitor function to check the signal level. Confirm that the measured value is not NC by using another test fixture to ensure a normal contact. If you find any failure, repair it.</p>
ERR (ERRor)	<p>Measurement error: Correct measured value cannot be obtained due to any error such as detection of voltage or current out of measurable range.</p> <p>Main causes will be as follows:</p> <ol style="list-style-type: none"> 1) Improper measurement range. 2) Noise mixed in. 3) Contact failure 	<ol style="list-style-type: none"> 1) Switch to proper measurement range. 2) Use electrostatic shield to prevent peripheral noise from mixing in. 3) Clean the contacts. <p>The measured value read by the remote control is the error value 9.9E+37.</p>
ALC Err (ALC Error)	<p>ALC error: Though ALC is enabled, the voltage or current monitored value cannot be adjusted within the specified range.</p> <p>Main causes will be as follows:</p> <ol style="list-style-type: none"> 1) Out of adjustable range. 2) Since the DUT has strong nonlinear voltage-current characteristics, the built-in algorithm failed to adjust. 3) Since the DUT parameter value varies, repetitive adjustment failed to obtain the specified value. 	<ol style="list-style-type: none"> 1) No corrective action available. Use the device on the measurement signal level in a range of 10mVrms to 5Vrms. 2) Adjust manually the measurement signal level so that the monitored value becomes the specified value. 3) Adopt the measured value successfully obtained by the measurement. <p>The measured value read by the remote control is the error value 9.9E+37.</p> <p>The voltage and current measured values are displayed even if out of specified range.</p>
CORR Err (CORRection Error)	<p>Correction error: Since the OPEN correction value and SHORT correction value are too close or reversed, any of OPEN, SHORT, and LOAD corrections cannot be executed.</p>	<p>Measure or set the correction value in a range where the OPEN correction value is two times larger than the SHORT correction value.</p> <p>The measured value read by the remote control is the error value 9.9E+37.</p>
OVF (OVerFlow)	<p>Overflow: Measured value exceeds the display range.</p>	<p>Switch to proper measurement range. Measured value may be displayed by changing the type of parameters.</p> <p>In the remote control, the measured value is output within the specified range of remote control, regardless of the display.</p>

5.2 When the Device Appears to be a Problem

When the device appears to be a problem, check the following table to see if a corrective action is given. When the problem persists or the device cannot be recovered though a corrective action was taken, please contact NF Corporation or one of our representatives.

Table 5-1 When the device appears to be a problem 1/4

Content	Possible cause	Corrective action
The power does not turn on	The power cord is not connected correctly. The power supply out of rated range is used.	Insert the power cord tightly. Check the voltage of power outlet with a multimeter.
Panel operation dose not work	The key lock is turned on.	When KEY LOCK lamp is lighting, press the [SHIFT] + [KEY LOCK] keys to cancel the key lock.
	/KEY_LOCK signal of handler interface is active (Low).	Make the /KEY_LOCK signal inactive (High). No other resetting method is available.
	The device is in remote state.	When REMOTE lamp is lighting, press the [LOCAL] key to return to the local state. If the local lockout is set with USB or GPIB, the device cannot return to the local from the panel operation. Return the device to local from the controller, or disconnect the USB cable or GPIB cable.
	Keys are deteriorated.	Please ask NF Corporation or one of our representatives for repair.
Trigger is not applied	By *RST command :INIT:CONT OFF setting is retained. In this case, the trigger is not applied even if trigger source is INT (internal).	Try to perform the following operations: •Initiate the trigger system with :INIT:CONT ON or :INIT command. •Press the [SHIFT] + [INIT] keys and then the [1] key to execute initialization. •Turn off and on the power.
	Trigger source setting is incorrect.	Check the trigger source setting. For example, to apply the trigger by remote control (USB, RS-232, GPIB, LAN), set the trigger source to BUS. At this time, manual trigger is ineffective.
Device does not operate as described in the Instruction Manual / Remote control commands do not function as expected	Settings are not initialized.	In general, the operations are described, provided that the settings have been initialized. Retry after initialization by pressing the [SHIFT] + [INIT] keys and then the [1] key.
	Operation mode is incorrect.	Set the operation mode correctly by referring to “4.18 Switching the Operation Mode”. The underline cursor is displayed at the bottom right of display in other than standard operation mode.

5.2 When the Device Appears to be a Problem

Table 5-1 When the device appears to be a problem 2/4

Content	Possible cause	Corrective action
Large variations of measured value	Measurement speed is too fast.	Reduce the measurement speed within allowable range. If the averaging function is used together, more precise speed can be set.
	Signal level is too small.	Increase the signal level.
	Measurement started before the signal settles.	Make the trigger delay time longer. Start the measurement after the contact becomes stable and the signal settled.
	The current cables and voltage cables interfere with each other (measured value varies when the cables move).	Twist the current cable to current cable and the voltage cable to voltage cable respectively to reduce the mutual interference.
	Noise mixes in.	<p><Electrostatic induction> When high impedance is measured, electrostatic-shield the L-side signal wires appropriately. Exposed signal wires cause the device to be affected by peripheral potential variations. Also, ground the case and peripheral conductors.</p> <p><Electromagnetic induction> Route the connection cables so that a large loop is not formed.</p> <p><Common impedance coupling> Do not ground outer conductor of connection cables. If grounded, noise current or a signal of adjacent LCR meter will flow in, affecting the measurement.</p>
	Signals interfere between multiple LCR meters.	With the triggered drive enabled, adjust the trigger timing so that the measurement signals of respective meters do not overlap temporally.
	Two-terminal connection is made.	Make four-terminal connection. If low impedance is measured with two-terminal connection, contact resistance will have strong effect. Do not connect between H _{CUR} and H _{POT} or between L _{CUR} and L _{POT} in the middle of wiring.
	Contact to DUT is unstable.	Clean the contacts. Turn on the contact check to check for abnormality. The contact resistance can be checked with resistance value between H _{CUR} and H _{POT} or between L _{CUR} and L _{POT} . The influence of contact resistance can be checked by replacing a contact point with known series resistance.
Measurement signal becomes small due to damage of measurement signal source or defective connection cables.	Check the magnitude of signal with a voltage monitor or current monitor. If discharge is made to measurement terminals, the measurement signal source, voltage detector, or current detector may be damaged. Check the cables for disconnection, or the inner and outer conductors for short-circuit.	

5.2 When the Device Appears to be a Problem

Table 5-1 When the device appears to be a problem 3/4

Content	Possible cause	Corrective action
Measured value differs largely from the expected value, measurement is impossible, or correction values cannot be measured	Wrong correction values are set.	Try to turn off OPEN, SHORT, and LOAD correction. Check the frequency range for correction. Re-measure or re-set correction values.
	Measurement conditions are incorrect.	Set the frequency and signal level to the specified values. Measured value may vary largely with the measurement conditions depending on the DUT.
	Improper measurement range is held.	Switch to a proper measurement range, or enable the auto selection of measurement range.
	The shield-to-shield connection of connection cables is not made.	For four connection cables, connect their outer conductor (shields) together. Otherwise, a return path of measurement current is not formed, causing a measurement failure.
	Connection cables to DUT or contacts are defective.	Check the cables for continuity, or the inner and outer conductors for short-circuit, or the contacts for contamination. If a contact failure of the L _{CUR} terminal occurs, the bridge may be unbalanced to cause an error display.
	The L side of DUT is grounded. Or, DUT is grounded with low impedance.	Do not connect the DUT's terminal to the ground. It can be checked with a multimeter. ZM2376 cannot measure the grounded DUT. This is also true for the measurement of correction values.
	Internal impedance bridge is unstable (too large capacitance between L terminal of DUT and ground).	Including the capacitance of four connection cables, reduce the capacitance between L terminal of DUT and ground. Check the capacitance to ground (capacitance to shield), which may be very large for a large DUT or DUT having complex construction.
	Noise mixes in. Exposed signal lines (particularly L side) are near to a portion where potential variations are extreme.	When measuring high impedance such as OPEN correction, electrostatic-shield the signal lines or ensures adequate distance from noise sources. Ground the case and peripheral conductors. When the signal level is small or the frequency is high, the device is likely to be interfered.

5.2 When the Device Appears to be a Problem

Table 5-1 When the device appears to be a problem 4/4

Content	Possible cause	Corrective action
Measurement is slow	Refreshing of display is slow. Or, same measured value is obtained repeatedly, and thus the measured value does not change.	No corrective action available. When the measurement speed is fast, the device thins out and displays the measured results so that the measured values can be read appropriately. The measurement itself is executed at the specified speed.
	Averaging is executed.	Check the setting of averaging count, and set it to 1 if the averaging is not necessary.
	Long delay time is set.	Check the trigger delay time, and set it to minimum necessary value. When the trigger source is internal, set it to initial value (8ms) or zero.
	The measurement range is switched by the range automatic selection function. The measurement range is not determined due to a noise or contact failure.	When many DUTs having almost same value are measured, set the measurement range to HOLD. The settling wait time with the automatic selection enabled can be adjusted depending on the situation.

6. MAINTENANCE

6.1 Preface	6-2
6.2 Daily Maintenance	6-3
6.3 Storage, Repacking, and Transportation	6-3
6.4 Checking Version Number	6-3
6.5 Checking Isolation	6-4
6.6 Performance Testing	6-4
6.6.1 Measurement Frequency Accuracy	6-5
6.6.2 Measurement Signal Level Accuracy	6-5
6.6.3 Voltage Monitor Accuracy	6-6
6.6.4 DC Bias Voltage Accuracy	6-7
6.6.5 AC Impedance Measurement Accuracy	6-8
6.6.6 DC Resistance Measurement Accuracy	6-13
6.7 Calibration	6-15

6.1 Preface

The following maintenance is essential for using the device under the best condition.

- Operation Inspection: Check if the device operates properly.
- Performance Testing: Check if the device respects the rated values.
- Adjustment, calibration: If the rated values are not satisfying, NF Corporation will make the necessary adjustment or calibration to restore performance.
- Damage repairs: When performance cannot be restored by the adjustment or calibration, NF Corporation will identify the cause and location of the damage and will execute repairs.

This instruction manual describes how to easily proceed with a performance testing.

For more accurate inspections, adjustments, calibration or repairs, contact NF Corporation or one of our representatives.

The following measurement instrument and standard are needed for the performance test.

- Frequency counter: Accuracy: within $\pm 10 \times 10^{-6}$
Reciprocal type, with noise rejection filter
- AC voltmeter: RMS value display
Accuracy: $\pm 0.5\%$ (1kHz)
Input resistor: approx. $1M\Omega$ or more
- DC voltmeter: Accuracy: $\pm (0.5\% + 0.3mV)$ (10V range)
Input resistance: approx. $10M\Omega$ or more
- Multimeter: Should be able to make a diode test for measuring the voltage at approximately 1mA in test current
- Standard capacitor: 1pF, 10pF, 100pF, 1nF, 10nF, 100nF, 1 μ F
- Standard resistor: 10m Ω , 100m Ω , 1 Ω , 10 Ω , 100 Ω , 1k Ω , 10k Ω , 100k Ω , 1M Ω , 10M Ω
The standard capacitor and the standard resistor should be calibrated under the actual test conditions.
- Others: OPEN standard, SHORT standard

6.2 Daily Maintenance

When the housing/panel surface needs cleaning, wipe with a soft cloth. To remove persistent contamination, wipe with a soft cloth soaked with neutral detergent and wrung out. Do not use any organic solvents like thinner or benzene, or any chemical cleaning cloth, as they may cause the surface finish to deteriorate, tarnish, or come off.

6.3 Storage, Repacking, and Transportation

Keep ZM2376 in a location that fills the installation requirements.

☞ Installation conditions ☞ “2.2.2 Installation Conditions”

When repacking is necessary, for transportation for example, use a case that is of sufficient size and strength, use filling that can withstand the weight of the instrument and make sure the instrument is sufficiently protected.

During transportation, handle the instrument, taking care not to apply strong shocks to the instrument.

6.4 Checking Version Number

The version number of ZM2376 firmware is displayed after power-on.

☞ “3.2.2 Displays and Indications at Power “ON” ”

During in use, the version can be checked in the system setting menu.

☞ “4.16 Checking the Version”

It is also possible to read out the version by means of *IDN? (Query).

☞ ZM2376 Instruction Manual (Remote Control) “5.3.1 Common Commands”

NF Corporation may offer a new improved version without notice. Please check our Web site and update if necessary.

☞ <http://www.nfcorp.co.jp/>

When turning the power on, also check the displayed test pattern (full dot display pattern) and all lamps being lit.

6.5 Checking Isolation

Remove all power cord, cable and etc of ZM2376 to separate it from others.

Fix the measurement range of multimeter to the range, which can be measured by the specified test current.

Set the multimeter to diode test mode (test current 1mA), and measure between the outer conductor of each BNC connector on front panel of ZM2376 and the ground terminal (case) at bottom left.

Make sure that the voltage is within the range stated below. When out of this range, it might be possibly damaged.

- H_{CUR} vs. Case 0.4 to 0.8V (approx. 0.6V, the typical value at room temperature)
- H_{POT} vs. Case 0.3 to 0.7V (approx. 0.5V, the typical value at room temperature)
- L_{POT} vs. Case 0.3 to 0.7V (approx. 0.5V, the typical value at room temperature)
- L_{CUR} vs. Case 0 to 0.1V (approx. 0mV)

6.6 Performance Testing

Performance testing is conducted as part of preventive maintenance to prevent performance degradation of ZM2376. Besides, conduct it if needed after acceptance inspection, periodic inspection or repair.

If the result of a performance testing does not meet the specifications, calibration or repair is required. Contact NF Corporation or one of our representatives.

The performance testing should be conducted in the following conditions.

- Power supply voltage: 100 to 230V \pm 10% (250V or less)
- Ambient temperature: 23 \pm 5°C
- Ambient humidity: 20 to 70%RH, non-condensing
- Warm-up: 30 min or more
- Operation mode 0: Should be set at first by referring to “4.18 Switching the Operation Mode (alternative command)”. If you do not use the remote control, the operation mode needs not to be set.

Take the following precautions when you conduct a performance testing.

- The setting contents for each test item contains the descriptions of items which should be further changed after initializing the setting.

Initialization of settings  “3.5.4 Initialization” SHIFT + [INIT] and 1 key operations

6.6.1 Measurement Frequency Accuracy

Connection: Connect the HCUR terminal and the frequency counter input with a coaxial cable.

Setting: After the initialization ([SHIFT] + [INIT], and [1] key operations), set the measurement frequency 1kHz (initial value) and measurement signal level 1Vrms (initial value).

Measurement: Measure the frequency with the frequency counter.

Evaluation: If the values on the counter are within the following range, it is normal.
Set value $\pm 100\text{ppm}$ (0.999900 to 1.000100kHz)

Remarks: For the measurement of 1kHz, a reciprocal type counter equipped with a noise rejection filter is suitable. If an unsuitable counter is used, it will cause a wrong trigger or an insufficient resolution, resulting in an incorrect measurement. In such a case, set the measurement frequency to 1MHz and execute the measurement with gate time of 1s.

6.6.2 Measurement Signal Level Accuracy

Connection: Connect the HCUR terminal and the input terminal of AC voltmeter with a coaxial cable. The cable length should be approx. 1m or less.

Setting: After initializing the setting, set the measurement frequency and measurement signal level according to the contents in table stated below.

Measurement: Measure the output voltage with the AC voltmeter.

Evaluation: If the values indicated on AC voltmeter are within the specification range in table, it is normal.

Measurement signal level	Measurement frequency 1kHz (initial value)
	Values indicated on AC voltmeter Specification: $\pm (8\% + 5 \text{ mVrms})$
0.1Vrms	87m to 113mVrms
1Vrms	0.915 to 1.085Vrms
5Vrms	4.595 to 5.405Vrms

6.6.3 Voltage Monitor Accuracy

Connection: H_{CUR} and H_{POT} terminals together → AC voltmeter input (- terminal)
 L_{CUR} and L_{POT} terminals together → AC voltmeter input (+ terminal)
 For the connection, use a kelvin clip test leads (2325AL, etc.).

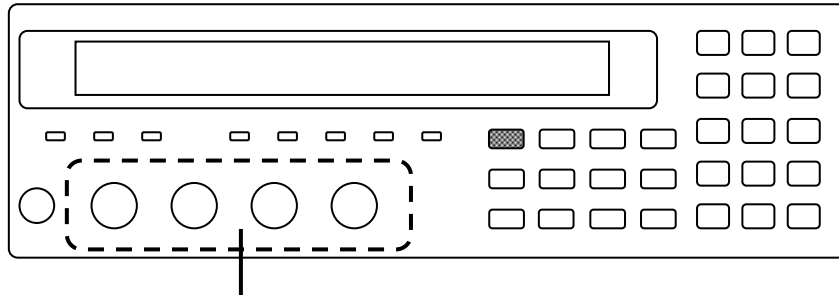

Kelvin clip test leads, etc. H terminal → + terminal AC voltmeter
 L terminal → - terminal

If a multimeter powered by AC source is used, a large capacitance to earth is connected to the L-side terminal, so the LCR meter gets unstable and correct measurement may not be done. Therefore, we recommend you to connect +/- inversely.

Setting: After initializing the setting, set the measurement frequency and measurement signal level according to the contents in table stated below.
 Press the **AUX DISP** key to display the auxiliary display selection menu, and select the current / voltage monitored value (I-V).

Measurement: Measure the output voltage under each condition with the AC voltmeter.

Evaluation: If the values of voltage monitor are within the specification range in table for the specified values of voltmeter, it is normal.

Measurement signal level	Measurement frequency 1kHz (initial value)		
	Values indicated on AC voltmeter Specification: ±(2% + 2mVrms)		
0.1Vrms	Monitor	mVrms	Specification: ± 4.0mVrms Difference: mVrms
	Voltmeter	mVrms	
1Vrms	Monitor	Vrms	Specification: ± 0.022Vrms Difference: Vrms
	Voltmeter	Vrms	
5Vrms	Monitor	Vrms	Specification: ± 0.102Vrms Difference: Vrms
	Voltmeter	Vrms	

6.6.4 DC Bias Voltage Accuracy

Connection: H_{CUR} and H_{POT} terminals together → AC voltmeter input (- terminal)
 L_{CUR} and L_{POT} terminals together → AC voltmeter input (+ terminal)
 For the connection, use a kelvin clip test leads (2325AL, etc.).
 To use the coaxial cable, connect 4 shields all together.

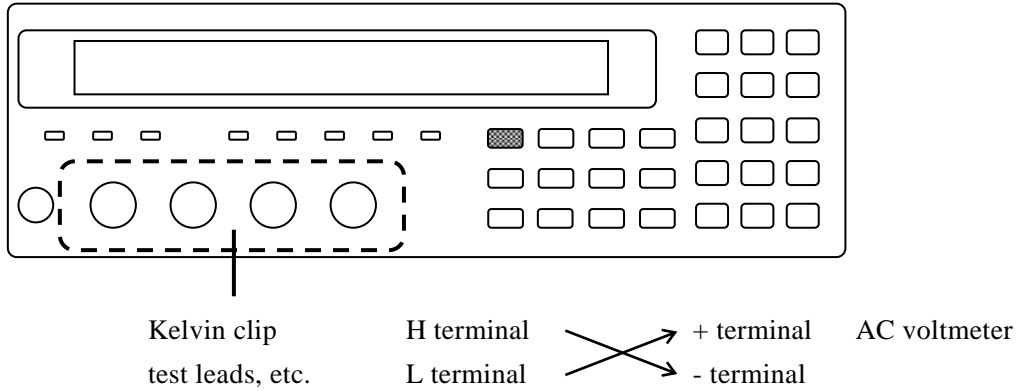

Setting: After initializing the setting, set the measurement frequency to 1kHz (initial value) and the measurement signal level to 0.1Vrms.

Press the **BIAS** key to display the DC Bias setting menu, and turn on the DC Bias. Set the DC Bias voltage according to the contents in table stated below in order of precedence.

Measurement: Measure the DC Bias voltage with the DC voltmeter which is fixed at 10V range. As the AC voltage is superimposed, correct measurement may not be performed if the automatic range is enabled on the voltmeter.

Evaluation: If the values on DC voltmeter are within the specification range of table, it is normal.

		Values indicated on DC voltmeter Specification: ± (2% + 5mV)
DC bias voltage	0.000 V	-0.0050 V to +0.0050 V
	1.000 V	-1.0250 V to -0.9750 V
	2.500 V	-2.555 V to -2.445 V
	5.000 V	-5.105 V to -4.895 V

CAUTION: The polarity is inversed due to the connection.

6.6.5 AC Impedance Measurement Accuracy

Described here is the easy checking method. For the correct test, request NF Corporation to make test.

Standard: To make correct test, prepare a 4-terminal-pair standard with approximately 1/3 or less in calibration accuracy against the accuracy of ZM2376. Described here is an example of test where easy-to-available standard is used.

When the frequency is low (for example, 120Hz), you can use a resistor whose calibration value of impedance is not provided at each frequency for a simple test, by considering its impedance equal to the DC resistance. For the range of 10Ω to 100kΩ having good frequency response, you can obtain the impedance at 100kHz or less for a simple test in the following procedure.

- Calibration value Rdc of DC resistance
- From the equivalent series inductance Ls[H] at 1MHz or the equivalent parallel capacitance Cp[F], calculate the complex impedance \dot{Z} by:

$$\dot{Z} = R_{dc} + j \omega L_s \quad \text{or} \quad \dot{Z} = 1 / (1/R_{dc} + j (\omega C_p))$$

$$|\dot{Z}| = \sqrt{R_{dc}^2 + (\omega L_s)^2} \quad \text{or} \quad |\dot{Z}| = R_{dc} / \sqrt{R_{dc}^2 + (\omega C_p)^2 + 1}$$

$$\theta = \tan^{-1}(\omega L_s / R_{dc}) \quad \text{or} \quad \theta = -\tan^{-1}(\omega C_p R_{dc})$$

where angular frequency $\omega = 2\pi f$, f is frequency[Hz]

When a calibrated general resistor is connected via test fixture to be used as the standard, the test should be only intended for quick operation check, since additional errors occur due to the test fixture or due to surrounding environment differences from the calibration.

Connection: Connect the standard to the measurement terminal of ZM2376.

Setting: After initializing the setting, setting as shown below.

Measurement frequency = 120Hz, 1kHz, 10kHz, 100kHz, 1MHz, 5MHz

Measurement signal level = 1V (initial value)

Measurement speed = SLOW, Averaging count = 1 (initial value)

Cable length correction = 0m (initial value)

Measurement range = Fix it to the specified range.

Auto selection may not allow the specified measurement range. Accordingly, be sure to fix it to the specified measurement range.

Measurement: First, measures the OPEN correction and SHORT correction.

Thereafter, measure the standard according to the contents in table shown below.

Evaluation: If the measurement values are within the range stated below, it is approximately correct.

Calibration value of standard \pm (Calibration accuracy of standard + Accuracy specification of ZM2376)

6.6 Performance Testing

The specification values in the following table are calculated based on the fact that calibration value of standard is equal to the nominal value, and are rounded to 2-digit in significant digit.

Measurement frequency 120Hz, Measurement signal level 1 Vrms, Cable length 0m

Measurement range	Standard (nominal value)	Calibration value of standard A		Measured value B		Difference $100 \times (B-A)/A$	Specification
						B-A	
1M Ω	1000pF	C	F	C	F	C %	C \pm 0.35 %
		D		D		D	D \pm 0.0035
100k Ω	0.01 μ F	C	F	C	F	C %	C \pm 0.011 %
		D		D		D	D \pm 0.00011
10k Ω	0.1 μ F	C	F	C	F	C %	C \pm 0.10 %
		D		D		D	D \pm 0.0010
1k Ω	1 μ F	C	F	C	F	C %	C \pm 0.10 %
		D		D		D	D \pm 0.0010
100 Ω	100 Ω	Z	Ω	Z	Ω	Z %	Z \pm 0.14 %
		θ	$^{\circ}$	θ	$^{\circ}$	θ $^{\circ}$	θ \pm 0.080 $^{\circ}$
10 Ω	10 Ω	Z	Ω	Z	Ω	Z %	Z \pm 0.18 %
		θ	$^{\circ}$	θ	$^{\circ}$	θ $^{\circ}$	θ \pm 0.10 $^{\circ}$
1 Ω	1 Ω	Z	Ω	Z	Ω	Z %	Z \pm 0.27 %
		θ	$^{\circ}$	θ	$^{\circ}$	θ $^{\circ}$	θ \pm 0.16 $^{\circ}$
100m Ω	100m Ω	Z	Ω	Z	Ω	Z %	Z \pm 0.80 %
		θ	$^{\circ}$	θ	$^{\circ}$	θ $^{\circ}$	θ \pm 0.46 $^{\circ}$

Measurement frequency 1kHz, Measurement signal level 1 Vrms, Cable length 0m

Measurement range	Standard (nominal value)	Calibration value of standard A		Measured value B		Difference $100 \times (B-A)/A$	Specification
						B-A	
1M Ω	100pF	C	F	C	F	C %	C \pm 0.44 %
		D		D		D	D \pm 0.0044
100k Ω	1000pF	C	F	C	F	C %	C \pm 0.12 %
		D		D		D	D \pm 0.0012
10k Ω	0.01 μ F	C	F	C	F	C %	C \pm 0.11 %
		D		D		D	D \pm 0.0011
1k Ω	0.1 μ F	C	F	C	F	C %	C \pm 0.098 %
		D		D		D	D \pm 0.0010
100 Ω	1 μ F	C	F	C	F	C %	C \pm 0.098 %
		D		D		D	D \pm 0.0010
10 Ω	10 Ω	Z	Ω	Z	Ω	Z %	Z \pm 0.16 %
		θ	$^{\circ}$	θ	$^{\circ}$	θ $^{\circ}$	θ \pm 0.093 $^{\circ}$
1 Ω	1 Ω	Z	Ω	Z	Ω	Z %	Z \pm 0.25 %
		θ	$^{\circ}$	θ	$^{\circ}$	θ $^{\circ}$	θ \pm 0.14 $^{\circ}$

6.6 Performance Testing

Measurement frequency 10kHz, Measurement signal level 1 Vrms, Cable length 0m

Measurement range	Standard (nominal value)	Calibration value of standard A		Measured value B		Difference 100×(B-A)/A	Specification
						B-A	
1MΩ	10pF	C	F	C	F	C %	C ± 0.86 %
		D		D		D	D ± 0.0086
100kΩ	100pF	C	F	C	F	C %	C ± 0.16 %
		D		D		D	D ± 0.0016
10kΩ	1000pF	C	F	C	F	C %	C ± 0.11 %
		D		D		D	D ± 0.0011
1kΩ	0.01μF	C	F	C	F	C %	C ± 0.098 %
		D		D		D	D ± 0.0010
100Ω	0.1μF	C	F	C	F	C %	C ± 0.11 %
		D		D		D	D ± 0.0011
10Ω	10Ω	Z	Ω	Z	Ω	Z %	Z ± 0.20 %
		θ	°	θ	°	θ °	θ ± 0.12 °

Measurement frequency 100kHz, Measurement signal level 1 Vrms, Cable length 0m

Measurement range	Standard (nominal value)	Calibration value of standard A		Measured value B		Difference 100×(B-A)/A	Specification
						B-A	
100kΩ	100kΩ	Z	Ω	Z	Ω	Z %	Z ± 0.33 %
		θ	°	θ	°	θ °	θ ± 0.19 °
10kΩ	10kΩ	Z	Ω	Z	Ω	Z %	Z ± 0.15 %
		θ	°	θ	°	θ °	θ ± 0.083 °
1kΩ	1kΩ	Z	Ω	Z	Ω	Z %	Z ± 0.14 %
		θ	°	θ	°	θ °	θ ± 0.081 °
100kΩ	10pF	C	F	C	F	C %	C ± 0.41 %
		D		D		D	D ± 0.0041
10kΩ	100pF	C	F	C	F	C %	C ± 0.17 %
		D		D		D	D ± 0.0017
1kΩ	1000pF	C	F	C	F	C %	C ± 0.16 %
		D		D		D	D ± 0.0016
100Ω	0.01μF	C	F	C	F	C %	C ± 0.11 %
		D		D		D	D ± 0.0011
10Ω	10Ω	Z	Ω	Z	Ω	Z %	Z ± 0.23 %
		θ	°	θ	°	θ °	θ ± 0.13 °

For the 1kΩ, 10kΩ, and 100kΩ ranges, either a standard resistor or a standard capacitor should be used for the test.

6.6 Performance Testing

Measurement frequency 1MHz, Measurement signal level 1Vrms, Cable length 0m

Measurement range	Standard (nominal value)	Calibration value of standard A		Measured value B		Difference $100 \times (B-A)/A$	Specification
						B-A	
1k Ω	100pF	C	F	C	F	C %	C \pm 0.41 %
		D		D		D	D \pm 0.0041
100 Ω	1000pF	C	F	C	F	C %	C \pm 0.22 %
		D		D		D	D \pm 0.0022
100k Ω	100k Ω	Z	Ω	Z	Ω	Z %	Z \pm 2.9 %
		θ	$^{\circ}$	θ	$^{\circ}$	θ $^{\circ}$	$\theta \pm 1.7^{\circ}$
10k Ω	10k Ω	Z	Ω	Z	Ω	Z %	Z \pm 1.0 %
		θ	$^{\circ}$	θ	$^{\circ}$	θ $^{\circ}$	$\theta \pm 0.57^{\circ}$
1k Ω	1k Ω	Z	Ω	Z	Ω	Z %	Z \pm 0.37 %
		θ	$^{\circ}$	θ	$^{\circ}$	θ $^{\circ}$	$\theta \pm 0.21^{\circ}$
100 Ω	100 Ω	Z	Ω	Z	Ω	Z %	Z \pm 0.20 %
		θ	$^{\circ}$	θ	$^{\circ}$	θ $^{\circ}$	$\theta \pm 0.11^{\circ}$
10 Ω	10 Ω	Z	Ω	Z	Ω	Z %	Z \pm 0.37 %
		θ	$^{\circ}$	θ	$^{\circ}$	θ $^{\circ}$	$\theta \pm 0.21^{\circ}$

For the 100 Ω and 1k Ω ranges, either a standard resistor or a standard capacitor should be used for the test.

Measurement frequency 5MHz, Measurement signal level 1Vrms, Cable length 0m

Measurement range	Standard (nominal value)	Calibration value of standard A		Measured value B		Difference $100 \times (B-A)/A$	Specification
						B-A	
1k Ω	1k Ω	Z	Ω	Z	Ω	Z %	Z \pm 1.8 %
		θ	$^{\circ}$	θ	$^{\circ}$	θ $^{\circ}$	$\theta \pm 1.0^{\circ}$
100 Ω	100 Ω	Z	Ω	Z	Ω	Z %	Z \pm 1.6 %
		θ	$^{\circ}$	θ	$^{\circ}$	θ $^{\circ}$	$\theta \pm 0.91^{\circ}$
10 Ω	10 Ω	Z	Ω	Z	Ω	Z %	Z \pm 2.3 %
		θ	$^{\circ}$	θ	$^{\circ}$	θ $^{\circ}$	$\theta \pm 1.3^{\circ}$

6.6 Performance Testing

Measurement signal level 0.1Vrms, Measurement frequency 1kHz, Cable length 0m

Measurement range	Standard (nominal value)	Calibration value of standard A		Measured value B		Difference $100 \times (B-A)/A$	Specification
						B-A	
100k Ω	1000pF	C	F	C	F	C %	C \pm 0.43 %
		D		D		D	D \pm 0.0043

Measurement signal level 0.1Vrms, Measurement frequency 1MHz, Cable length 0m

Measurement range	Standard (nominal value)	Calibration value of standard A		Measured value B		Difference $100 \times (B-A)/A$	Specification
						B-A	
1k Ω	100pF	C	F	C	F	C %	C \pm 1.7 %
		D		D		D	D \pm 0.017

Measurement signal level 5Vrms, Measurement frequency 1kHz, Cable length 0m

Measurement range	Standard (nominal value)	Calibration value of standard A		Measured value B		Difference $100 \times (B-A)/A$	Specification
						B-A	
100k Ω	1000pF	C	F	C	F	C %	C \pm 0.22 %
		D		D		D	D \pm 0.0022

Measurement signal level 5Vrms, Measurement frequency 1MHz, Cable length 0m

Measurement range	Standard (nominal value)	Calibration value of standard A		Measured value B		Difference $100 \times (B-A)/A$	Specification
						B-A	
1k Ω	100pF	C	F	C	F	C %	C \pm 1.9 %
		D		D		D	D \pm 0.019

6.6.6 DC Resistance Measurement Accuracy

- Standard:** To make correct test, prepare a 4-terminal-pair standard with approximately 1/3 or less in calibration accuracy against the accuracy of ZM2376. For the measurement of low resistance, a 4-terminal connection is required to avoid an effect from contact resistance.
- Connection:** Connect the standard resistor to the measurement terminal of ZM2376.
- Setting:** After initializing the setting, setting as shown below.
 Primary parameter = Z
 Secondary parameter = Rdc
 Measurement speed = SLOW, Averaging count = 1 (initial value)
 Measurement range of DC resistance = Auto selection (initial value, it cannot be fixed by manual)
- Measurement:** First, measures the OPEN correction and SHORT correction.
 Thereafter, measure the standard resistance according to the contents in table shown below.
 Directly connect the standard with the measurement terminal of LCR meter (cable length= 0m).
- Evaluation:** If the measurement values are within the range stated below, it is approximately correct.
 Calibration value of standard \pm (Calibration accuracy of standard + Accuracy specification of ZM2376)

Measurement range of DC resistance	Standard resistor (nominal value)	Calibration value of standard resistor A	Measured value B	Difference 100x(B - A)/ A	Specification (According to measurement range)
1M Ω	10M Ω	Ω	Ω	%	$\pm 2.2\%$
1M Ω 100k Ω	1M Ω	Ω	Ω	%	$\pm 0.40\%$ $\pm 0.41\%$
100k Ω 10k Ω	100k Ω	Ω	Ω	%	$\pm 0.095\%$ $\pm 0.37\%$
10k Ω 1k Ω	10k Ω	Ω	Ω	%	$\pm 0.091\%$ $\pm 0.36\%$
1k Ω 100 Ω	1k Ω	Ω	Ω	%	$\pm 0.090\%$ $\pm 0.40\%$
100 Ω	100 Ω	Ω	Ω	%	$\pm 0.13\%$
100 Ω 10 Ω	10 Ω	Ω	Ω	%	$\pm 0.44\%$ $\pm 0.17\%$
10 Ω 1 Ω	1 Ω	Ω	Ω	%	$\pm 0.50\%$ $\pm 0.27\%$
1 Ω 100m Ω	100m Ω	Ω	Ω	%	$\pm 0.90\%$ $\pm 0.90\%$
100m Ω	10m Ω	Ω	Ω	%	$\pm 6.3\%$

Supplement: When it is possible to fix the measurement range of DC resistance with the remote control, fix it to the measurement range with high measurement accuracy. Since it is impossible to fix by manual, press the **SHIFT** + **[RANGE]** keys to display the Measurement range setting menu, check the measurement range of DC resistance, and then check the measurement accuracy at that measurement range.

6.7 Calibration

If the performance test does not satisfy the specification, NF Corporation will make the necessary adjustment or calibration to recover the performance. If necessary, contact NF Corporation or one of our representatives.

You will be liable for the costs of adjustment and calibration outside the warranty period.

7. SPECIFICATION

7.1 Specification	7-2
7.2 External Dimensions.....	7-16

Supplementary value: These values show the guideline data for reference and do not guarantee the performance.

7.1 Specification

■ Measurement parameters

- Primary parameters $|Z|$, $|Y|$, L, C, R, G
For equivalent circuit of L, C, and R, Parallel / Series / Auto Selection are selectable.
- Secondary parameters Q, D, θ , X, B, R_s , R_p , G, L_p , R_{dc} (direct-current resistance)
- Auto parameter selection Primary parameters (including equivalent circuit) and secondary parameters can be selected automatically.

■ Measured value display range

- $|Z|$ 0.000m Ω to 999.999M Ω
- R (R_s , R_p , R_{dc}), X 0 Ω , $\pm(0.001\text{m}\Omega$ to 999.999M Ω)
- $|Y|$ 0.00nS to 9.99999kS
- G, B 0 S, $\pm(0.01\text{nS}$ to 9.99999kS)
- C (C_p , C_s) 0 F, $\pm(0.00001\text{pF}$ to 99.9999kF)
- L (L_s , L_p) 0 H, $\pm(0.00001\text{nH}$ to 9.99999GH)
- Q, D 0, $\pm(0.00001$ to 99999.9)
- θ $\pm 180.000^\circ$

Actual measurement and display ranges of respective parameters are restricted by the measurement range or frequency.

■ Measurement conditions

- Measurement frequency 1mHz to 5.5MHz, Resolution 6 digits (1mHz when < 100Hz),
Accuracy $\pm 0.01\%$
- Measurement signal
 - Level Setting range 10mV to 5V, Resolution 3 digits (1mV when < 100mV)
 - Level accuracy $\pm (8\% + 5\text{mV}) \leq 1\text{MHz}$ (typical value when < 1Hz)
 $\pm (10\% + 5\text{mV}) > 1\text{MHz}$
RMS values at open output.
- ALC Constant voltage drive / Constant current drive / Disabled
 - Voltage setting range 10mV to 5V, Resolution 3 digits (1mV when < 100mV)
 - Current setting range 1 μA to 200mA, Resolution 3 digits (0.1 μA when < 10 μA)
 - The constant control range will be narrower than the above specifications depending on the product dispersion or DUT's impedance.
 - The current range is restricted depending on the measurement range.
- Output impedance 6 Ω / 25 Ω / 100 Ω (supplementary value).
The minimum output impedance can be selected from the above three values. However, it is limited by the measurement range, the signal level, and the frequency.
- Internal DC bias Setting range 0V to +5V, Resolution 1mV,
Accuracy $\pm (2\% + 5\text{mV})$ [Level $\leq 2\text{V}$]
 $\pm (2\% + 10\text{mV})$ [Level $> 2\text{V}$]
at signal frequency of 1 MHz or less, $23 \pm 10^\circ\text{C}$ (Environmental temperature), and open output.
It can be turned on / off.
- Trigger source

INT	Internal (automatic continuous trigger)
MAN	Manual
EXT	Handler interface
BUS	Remote control
- Trigger delay time Setting range 0s to 999.9999s, Resolution 0.0001s
(Time after input of trigger until start of signal acquisition)
- Triggered drive Drive only at measurement / Continuous drive selectable
(Measurement signal can be output only during the time from trigger to completion of signal acquisition)

- Measurement speed RAPid / FAST / MEDium / SLOW / VerySLOW

Typical measurement time

(Typical value. Time from input of trigger to output of measurement end signal EOM)

Measurement frequency	RAP	FAST	MED	SLOW	VSLO
120Hz	10ms	10ms	26ms	126ms	501ms
1kHz	2ms	5ms	25ms	121ms	501ms
10kHz	2ms	5ms	25ms	121ms	501ms
100kHz	2ms	5ms	25ms	121ms	501ms
1MHz	2ms	5ms	25ms	121ms	501ms

Conditions: Measurement range hold, Trigger delay time = 0,

Averaging count = 1, Secondary parameter \neq Rdc.

Signal acquisition time is the value subtracted by about 1ms from the above value.

DUT can be replaced immediately after the completion of signal acquisition.

After replacement of DUT, the signal settling time is required additionally.

It should be an appropriate trigger delay time and not zero.

Additional time when measuring direct-current resistance Rdc (supplementary value)

	RAP	FAST	MED	SLOW	VSLO
(DC)	150ms	150ms	150ms	218ms	616ms

Conditions: DC resistance measurement range fixed, Trigger delay time = 0,

Averaging count = 1.

• Measurement range

Measurement range	Recommended range	Measureable range	Output impedance
1M Ω	1M Ω to 11M Ω	$\geq 900\text{k}\Omega$	100 Ω
100k Ω	100k Ω to 1.1M Ω	$\geq 90\text{k}\Omega$	100 Ω
10k Ω	10k Ω to 110k Ω	$\geq 9\text{k}\Omega$	100 Ω
1k Ω	1k Ω to 11k Ω	$\geq 0.9\text{k}\Omega$	100 Ω
100 Ω	9 Ω to 1.1k Ω	No limitation	100 Ω (*1)
10 Ω	0.9 Ω to 10 Ω	$\leq 11\Omega$	100 Ω (*1)
1 Ω	90m Ω to 1 Ω	$\leq 1.1\Omega$	25 Ω / 6 Ω
100m Ω	9m Ω to 100m Ω	$\leq 110\text{m}\Omega$	25 Ω / 6 Ω

Measureable range: Approximate range in which measurement and display are possible (supplementary value).

- *1 For the 10 Ω and 100 Ω ranges, the output impedance may become 25 Ω or 6 Ω depending on the minimum output impedance setting. In this case, the recommended range and the measureable range for the 10 Ω and 100 Ω ranges change as follows:

Measurement range	Recommended range	Measureable range
100 Ω	100 Ω to 1.1k Ω	$\geq 90\Omega$
10 Ω	0.9 Ω to 110 Ω	Not limited

Recommended range: Recommended operating range for high accuracy measurement.

Limitations: When frequency > 20kHz, the 1M Ω range cannot be used.

When frequency > 1MHz, the measureable range is limited to between 1 Ω and 10k Ω ranges.

When frequency > 2MHz, the measureable range is limited to between 10 Ω and 1k Ω ranges.

The output impedance may be restricted depending on the frequency and signal level.

When cable length = 4m and frequency > 200kHz, the measureable range is limited to between 10 Ω and 10k Ω ranges.

• Measurement range selection Auto / Manual

■ Measurement accuracy

- Basic accuracy 0.08%
- Impedance measurement accuracy

Zr: Measurement range (100mΩ to 1MΩ)

Zx: Measured value of impedance magnitude |Z|

With the above definitions, the impedance measurement accuracy is obtained as follows:

Accuracy of impedance magnitude |Z| ±Az[%]

$$Az = (A + B \times U + Kz + Ky) \times K_T + (Kv + K_B) \times U \text{ (Level } \leq 1V)$$

$$Az = (A + B \times U + Kz + Ky) \times K_T + Kv + K_B \times U \text{ (Level } > 1V)$$

Accuracy of phase angle θ of impedance ±Pz[°]

$$Pz = 0.573 \times Az$$

The measurement accuracy when Az exceeds 10[%] is a supplementary value. Excluding the highest and the lowest ranges available for each frequency, the measurement accuracy for the measured value smaller than half the lower limit of each recommended measurement range or larger than twice the upper limit is a typical value.

Each parameter value in the expression is listed below.

- **U**: Ratio coefficient

Zx	U
> 100Ω	Zx / Zr (however, 1 when Zx / Zr < 1)
≤ 100Ω	Zr / Zx (however, 1 when Zr / Zx < 1)

If the measureable range for the 10Ω range becomes unlimited depending on the minimum output impedance setting, the following values should be used.

Zx	U
> 10Ω	Zx / Zr (however, 1 when Zx / Zr < 1)
≤ 10Ω	Zr / Zx (however, 1 when Zr / Zx < 1)

7.1 Specification

- **A** (upper row): Basic coefficient[%]
- **B** (lower row): Proportional coefficient[%]

For the measurement speeds, MED, SLOW, and VSLO, the coefficient is as shown in the table below.

For the measurement speeds, RAP and FAST, the coefficient is 1.1 times of the value shown below.

Measurement range Zr	Measurement frequency Hz						
	0 (DC)	999.999 ↑ 1m	1k	20k ↑ 1.00001k	50k ↑ 20.0001k	100k ↑ 50.0001k	200k ↑ 100.001k
1MΩ	0.20 0.15	0.15 0.10	0.12 0.15	0.30 0.30	---	---	---
100kΩ	0.06 0.03	0.06 0.03	0.06 0.03	0.06 0.06	0.08 0.08	0.20 0.08	0.20 0.08
10kΩ	0.06 0.03	0.06 0.03	0.06 0.03	0.06 0.03	0.07 0.03	0.10 0.04	0.15 0.04
1kΩ	0.06 0.03	0.06 0.03	0.05 0.03	0.05 0.03	0.06 0.03	0.10 0.04	0.12 0.04
100Ω	0.09 0.03	0.12 0.02	0.05 0.03	0.06 0.03	0.06 0.03	0.06 0.03	0.12 0.03
10Ω	0.08 0.04	0.12 0.06	0.10 0.06	0.12 0.08	0.12 0.08	0.12 0.10	0.12 0.10
1Ω	0.20 0.05	0.20 0.05	0.20 0.03	0.30 0.08	0.30 0.08	0.30 0.08	0.30 0.08
100mΩ	0.30 0.40	0.30 0.30	0.20 0.20	0.30 0.40	0.30 0.40	0.40 0.40	0.40 0.40

Measurement range Zr	Measurement frequency Hz					
	500k ↑ 200.001k	1M ↑ 500.001k	2M ↑ 1.00001M	3M ↑ 2.00001M	4M ↑ 3.00001M	5.5M ↑ 4.00001M
1MΩ	---	---	---	---	---	---
100kΩ	0.30 0.10	1.00 0.30	---	---	---	---
10kΩ	0.20 0.05	0.80 0.10	1.50 0.80	1.50 1.00	1.50 1.20	2.00 2.00
1kΩ	0.15 0.05	0.30 0.06	0.50 0.20	0.60 0.30	0.60 0.30	1.50 0.30
100Ω	0.14 0.03	0.15 0.04	0.30 0.05	0.40 0.08	0.40 0.08	1.50 0.08
10Ω	0.12 0.20	0.12 0.20	0.12 0.60	0.12 0.80	0.15 0.80	0.20 2.00
1Ω	0.30 0.50	0.30 0.50	0.60 0.60	---	---	---
100mΩ	0.50 1.00	0.50 1.00	---	---	---	---

The measurement accuracy is not guaranteed for "---".

The basic coefficient A of the 100Ω range is increased 1.5 times, when the output impedance is 25Ω or 6Ω below 1MHz.

• **Kc:** Cable length coefficient

Frequency range	Kc [%]
DC, Frequency \leq 1kHz	$0.01 \times (\text{Cable length[m]})$
1kHz < Frequency \leq 100kHz	$0.2 \times (\text{Cable length[m]})$
100kHz < Frequency \leq 1MHz	$0.5 \times (\text{Cable length[m]})^2$
1MHz < Frequency	$20 \times (\text{Cable length[m]})^2$

Restriction on measurement frequency and signal level depending on cable length

Cable length	Applicable frequency range	Applicable signal level
0m	All ranges including DC	All range
1m	DC, Frequency \leq 2MHz	All range
2m	DC, Frequency \leq 2MHz	All range
4m	DC, Frequency \leq 1MHz	All range for DC and frequency \leq 500kHz \leq 2V for frequency > 500kHz

The measurement accuracy is not guaranteed for frequencies and signal levels out of these ranges.

• **Kz:** Residual impedance coefficient

Frequency range	Kz [%]
DC, Frequency \leq 20kHz	$(0.02 + Kc) / Zx[\Omega]$
20kHz < Frequency \leq 100kHz	$(0.05 + Kc) / Zx[\Omega]$
100kHz < Frequency	$(0.5 + Kc) / Zx[\Omega]$

• **Ky:** Residual admittance coefficient

When the cable length is 0m, the coefficient is as shown in the table below.

When an extension cable (1m, 2m, or 4m) is used on the frequency of more 20kHz, the coefficient is 10 times of the value shown below.

Frequency range	Ky [%]
DC, Frequency \leq 50kHz	$Zx[\Omega] / (2 \times 10^7)$
50kHz < Frequency \leq 500kHz	$Zx[\Omega] \times (\text{Frequency[kHz]})^2 / (2 \times 10^{10})$
500kHz < Frequency	$Zx[\Omega] / (1 \times 10^5)$

7.1 Specification

• **Kv**: Signal level coefficient

For the DC resistance R_{dc} , $V = 0$.

The measurement accuracy is not guaranteed for signal levels $< 100\text{mV}$.

The measurement accuracy is not guaranteed for frequency $> 2\text{MHz}$, range = $10\text{k}\Omega$, and signal level $> 2\text{V}$.

For other measurement parameters, the coefficient is as shown in the table below.

Frequency $\leq 120\text{Hz}$

Measurement range Z_r	Signal level[Vrms]					
	200m ↑ 100m	500m ↑ 201m	999m ↑ 501m	1	2 ↑ 1.01	5 ↑ 2.01
1M Ω	0.40	0.10	0.10	0	0.10	0.15
100k Ω	0.10	0.02	0.02	0	0.03	0.10
10k Ω	0.10	0.02	0.02	0	0.03	0.10
1k Ω	0.10	0.01	0.01	0	0.03	0.10
100 Ω	0.10	0.03	0.03	0	0.03	0.15
10 Ω	0.20	0.03	0.01	0	0.04	0.04
1 Ω	0.40	0.10	0.02	0	0.03	0.03
100m Ω	3.5	0.80	0.50	0	0.03	0.03

120Hz $<$ Frequency $\leq 100\text{kHz}$

Measurement range Z_r	Signal level[Vrms]					
	200m ↑ 100m	500m ↑ 201m	999m ↑ 501m	1	2 ↑ 1.01	5 ↑ 2.01
1M Ω	0.40	0.10	0.10	0	0.10	0.20
100k Ω	0.20	0.05	0.05	0	0.02	0.10
10k Ω	0.10	0.02	0.02	0	0.03	0.20
1k Ω	0.10	0.02	0.02	0	0.03	0.20
100 Ω	0.15	0.05	0.05	0	0.10	0.20
10 Ω	0.15	0.05	0.05	0	0.10	0.10
1 Ω	0.10	0.01	0.01	0	0.01	0.01
100m Ω	1.5	0.20	0.10	0	0.01	0.01

100kHz $<$ Frequency

Measurement range Z_r	Signal level[Vrms]					
	200m ↑ 100m	500m ↑ 201m	999m ↑ 501m	1	2 ↑ 1.01	5 ↑ 2.01
100k Ω	4.00	1.00	0.10	0	0.10	0.15
10k Ω	4.00	1.00	0.10	0	0.10	0.15
1k Ω	0.80	0.10	0.10	0	0.30	1.5
100 Ω	0.20	0.05	0.05	0	0.50	3.0
10 Ω	0.20	0.05	0.05	0	0.10	1.0
1 Ω	0.10	0.01	0.01	0	0.01	0.20
100m Ω	1.5	0.20	0.10	0	0.01	0.01

• **KT:** Temperature-dependent coefficient

Ambient temperature (T °C)	KT	
	Frequency ≤ 20kHz	Frequency > 20kHz
0 to +18	$1 + 0.1 \times (18-T)$	$1 + 0.15 \times (18-T)$
+18 to +28	1	1
+28 to +40	$1 + 0.1 \times (T-28)$	$1 + 0.15 \times (T-28)$

• **KB:** DC bias coefficient

For the DC resistance R_{dc} , $K_B = 0$ [%].

When the internal DC bias is disabled, $K_B = 0$ [%].

When the internal DC bias is enabled, K_B [%] is as shown in the table below.

Measurement range Z_r	Frequency Hz					
	0 (DC)	120 ↑ 1m	20k ↑ 120.001	100k ↑ 20.0001k	1M ↑ 100.001k	5.5M ↑ 1.00001M
1MΩ	0	0.02	0.02	---	---	---
100kΩ	0	0.01	0.01	0.01	0.01	---
10kΩ	0	0.01	0.01	0.01	0.01	0.20
1kΩ	0	0.01	0.01	0.01	0.01	0.20
100Ω	0	0.01	0.01	0.01	0.01	0.30
10Ω	0	0.05	0.05	0.05	0.20	0.50
1Ω	0	---	0.20	0.20	0.50	0.50
100mΩ	0	---	---	---	---	---

The measurement accuracy is not guaranteed for "---".

• Other conditions

Warm-up	30 min or more
Zero correction	Execute OPEN correction and SHORT correction.
Cable Length Correction	Execute according to the connection cable length.
Calibration cycle	1 year

• Measurement accuracy of measurement parameters except Z and θ

From the measurement accuracy of impedance, obtain as follows.

Here, Q_x is a measured value of Q, D_x is a measured value of D, and θ_x is a measured value of θ . θ_x used for accuracy calculation may be obtained from $(90^\circ - \tan^{-1}|1/Q_x|)$ or $(90^\circ - \tan^{-1}|D_x|)$.

Parameter	Measurement accuracy
Y	$\pm Az$ [%]
L_p, L_s, X	$\pm Az$ [%] ($ Q_x \geq 10$), $\pm Az / \sin\theta_x$ [%] ($ Q_x < 10$)
C_p, C_s, B	$\pm Az$ [%] ($ D_x \leq 0.1$), $\pm Az / \sin\theta_x$ [%] ($ D_x > 0.1$)
R_p, R_s, G	$\pm Az$ [%] ($ Q_x \leq 0.1$), $\pm Az / \cos\theta_x$ [%] ($ Q_x > 0.1$)
Rdc	$\pm Az$ [%]
Q	$\pm Q_x^2 \times Pe / (1 - Q_x \times Pe)$ ($ Q_x \geq 10, Q_x \times Pe \leq 0.1$) Here, the phase angle error $Pe[\text{rad}] = 0.01 \times Az[\%]$. It differs from $Pz[^\circ]$. Measurement accuracy of Q is absolute value. It is not a % value.
D	$\pm(0.01 \times Az)$ ($ D_x \leq 0.1$) Measurement accuracy of D is absolute value. It is not a % value.

In general, a range of each measurement parameter (maximum value and minimum value) can be calculated based on an error circle of the impedance.

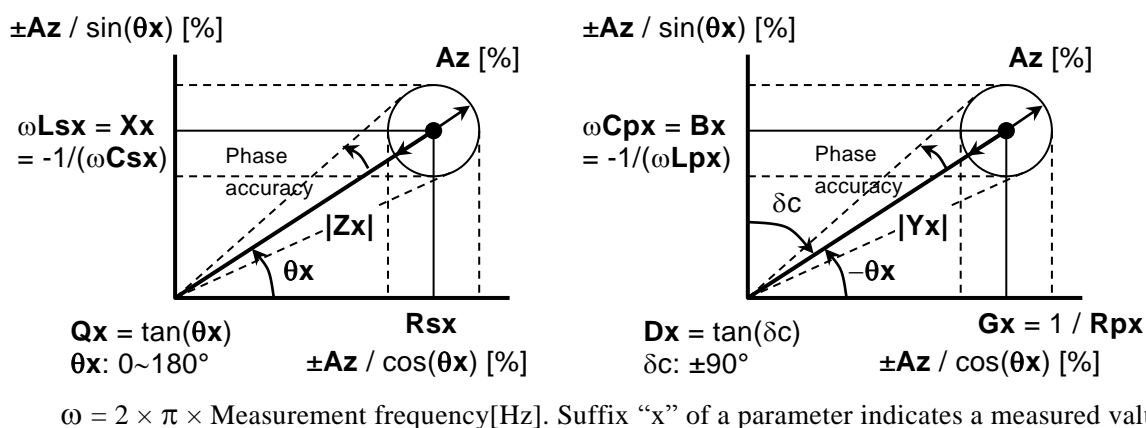

Figure 7-1 Range of error

7.1 Specification

Pure L[H] and C[F] can be converted into $|Z|[\Omega]$ by the following expression:

$$|Z|[\Omega] = 2 \times \pi \times \text{Frequency}[\text{Hz}] \times L[\text{H}]$$

$$|Z|[\Omega] = 1 / (2 \times \pi \times \text{Frequency}[\text{Hz}] \times C[\text{F}])$$

Approximate value can be read from the following graph.

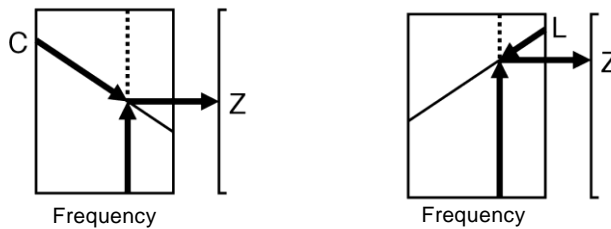
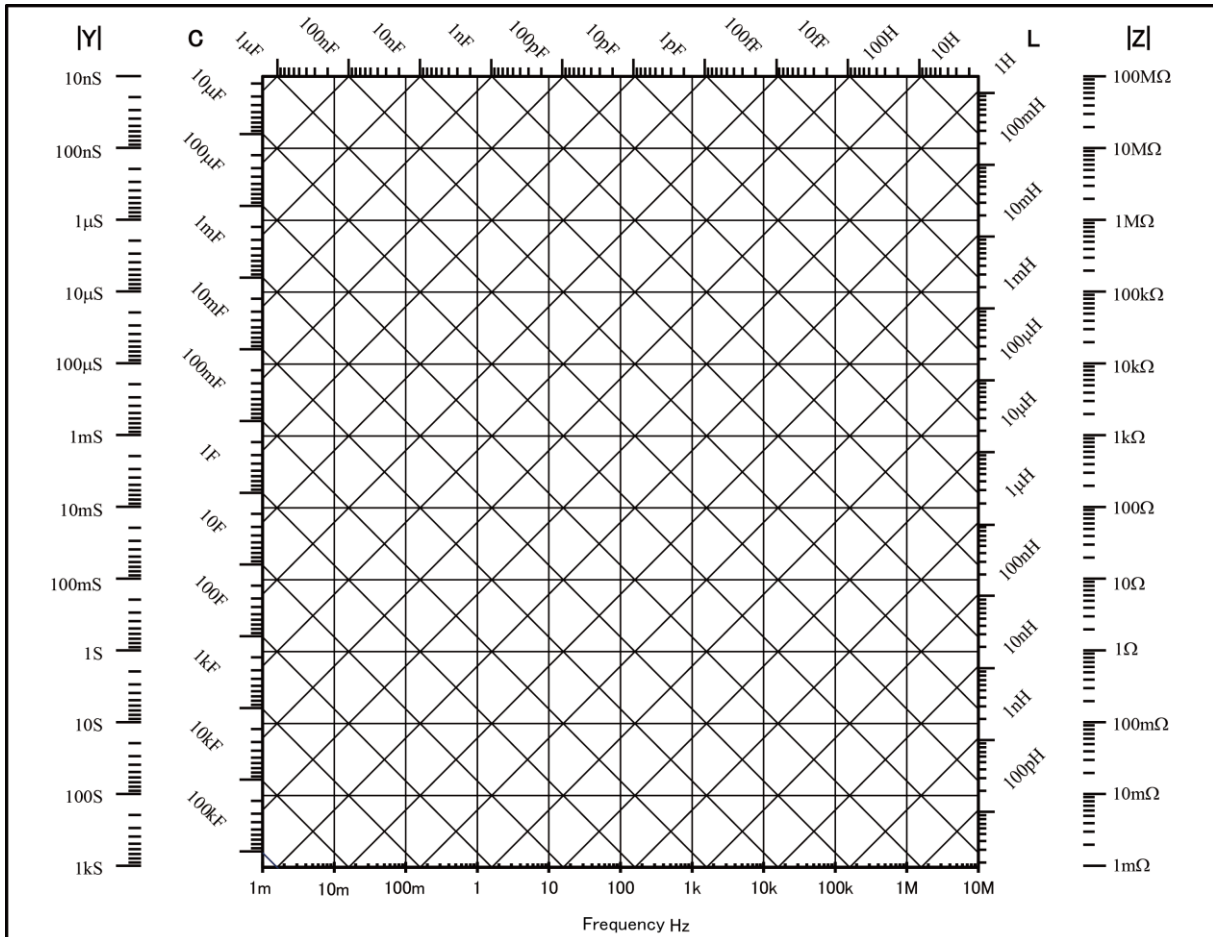

Figure 7-2 LC - Z conversion graph

■ Other measurement related functions

- Zero correction OPEN correction and SHORT correction provided. Both can be turned on or off.
- LOAD correction Provided. It can be turned on or off.
- Cable length correction 0m / 1m / 2m / 4m
- Contact check Provided.
Based on detection of an abnormally low capacitance or abnormal voltage/current.
- Averaging 1 to 256 times
- Deviation measurement Primary parameters: Deviation and deviation % from reference value can be displayed.
Secondary parameters: Deviation and deviation % from reference value can be displayed.
- Comparator Primary parameters: Max. 14 bins
Original measured value / Deviation / Deviation % can be sorted.
Secondary parameters: Upper limit and lower limit comparison
Original measured value / Deviation / Deviation % can be sorted.
Beeper: Sounds according to comparison result
(Pass / Fail / Off)
- Handler interface Signal isolation: All I/O signals are optically isolated
(withstand voltage $\pm 42\text{V}$)
Input signal: Trigger, Key lock, Settings/correction value memory designation.
High speed recalling with only spot correction value is possible.
Output signal: Comparison result BIN1 to BIN11, NC / BIN12, PHI / BIN13, PLO / BIN14, OUT OF BINS, S-NG, ERR, INDEX, EOM (when BIN10 - BIN14 are used, NC, PHI, and PLO cannot be used).
Rated power voltage: External +5V to +24V, Internal +5V (non-isolated)
- Multi-measurement Execute measurement and limit comparison under multiple conditions for the total comparison.
Maximum number of steps: 32
Selectable measurement conditions: Measurement frequency, measurement signal level, internal DC bias voltage, measurement parameters, etc.

-
- Monitor display
 - Voltage: Voltage value applied to the DUT
 - Voltage Monitor Accuracy
 - $\pm(2\%+2\text{mVrms})$ from 10Hz to 50kHz
 - $\pm(3.5\%+2\text{mVrms})$ over 50kHz to 100kHz
 - $\pm(5\%+5\text{mVrms})$ over 100kHz to 1MHz
 - $\pm(10\%+10\text{mVrms})$ over 1MHz to 5.5MHz
 - Current: Current value flowing in the DUT
 - Current monitor accuracy (supplementary value)
 - Voltage monitor accuracy + Measurement accuracy of impedance Z
 - Discharge protection
 - 4J or less when voltage is below 250V, or 0.5J or less when below 1kV.
 - (All are supplementary values)
 - For voltage V[V], the energy stored in capacitance C[F] is $(1/2) \times C \times V^2$ [J].
 - Remote control interface
 - USB
 - USBTMC, USB 1.1 Full-speed
 - RS-232
 - Data rate
 - 4800 / 9600 / 19200 / 38400 / 57600 / 115200 / 230400bps
 - For the data rate exceeding 19200bps, communication may fail depending on the characteristics of cable or controller.
 - Flow control
 - None, Software (X-ON/X-OFF), Hardware (RTS/CTS)
 - GPIB
 - Conforms to IEEE 488.1 and IEEE 488.2 Standards
 - LAN (optional)
 - 10BASE-T / 100BASE-TX, RJ-45 connector

■ General specifications

- Power Supply
 - Voltage: AC 100V to 230V $\pm 10\%$, but 250V or less
 - Frequency: 50Hz/60Hz $\pm 2\text{Hz}$
 - Power consumption: 75VA or less
 - Overvoltage category II
- Environmental conditions
 - Operation
 - Temperature: 0 to $+40^{\circ}\text{C}$
 - Humidity: 5 to 85%RH. Absolute humidity 1 to $25\text{g}/\text{m}^3$, non-condensing
 - Altitude: 2000m or less
 - Storage
 - Temperature: -10 to $+50^{\circ}\text{C}$
 - Humidity: 5 to 95%RH. Absolute humidity 1 to $29\text{g}/\text{m}^3$, non-condensing

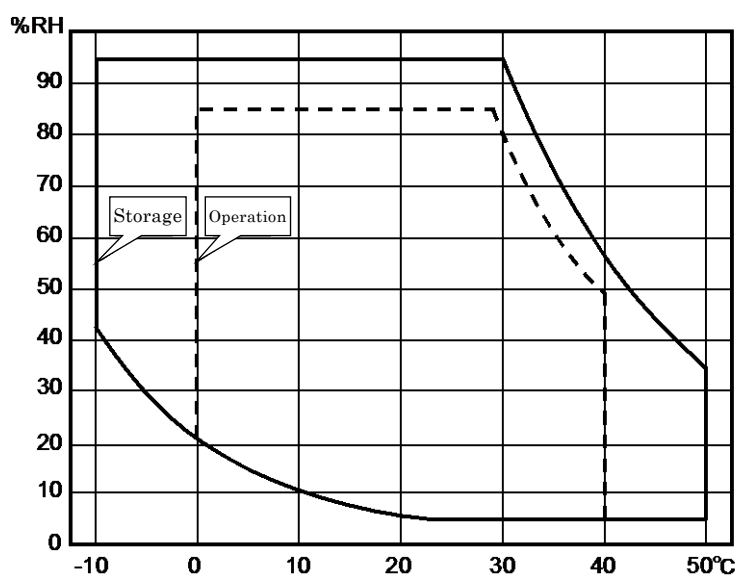

- Pollution degree 2 (indoor use)
- Safety EN 61010-1
EN 61010-2-030
- EMC EN 61326-1 (Group 1, Class A)
EN 61000-3-2
EN 61000-3-3
- RoHS Directive 2011/65/EU
- Warm-up Time 30 minutes
- Settings/correction value memory 32 sets. Settings and correction values can be saved and restore individually or together.
- Resume Last setting and correction value are restore at power-on.
- External dimensions Approx. 260 (W) \times 88 (H) \times 280 (D) mm, not including protuberances
- Weight Approx. 2.4kg (without accessories)

7.2 External Dimensions

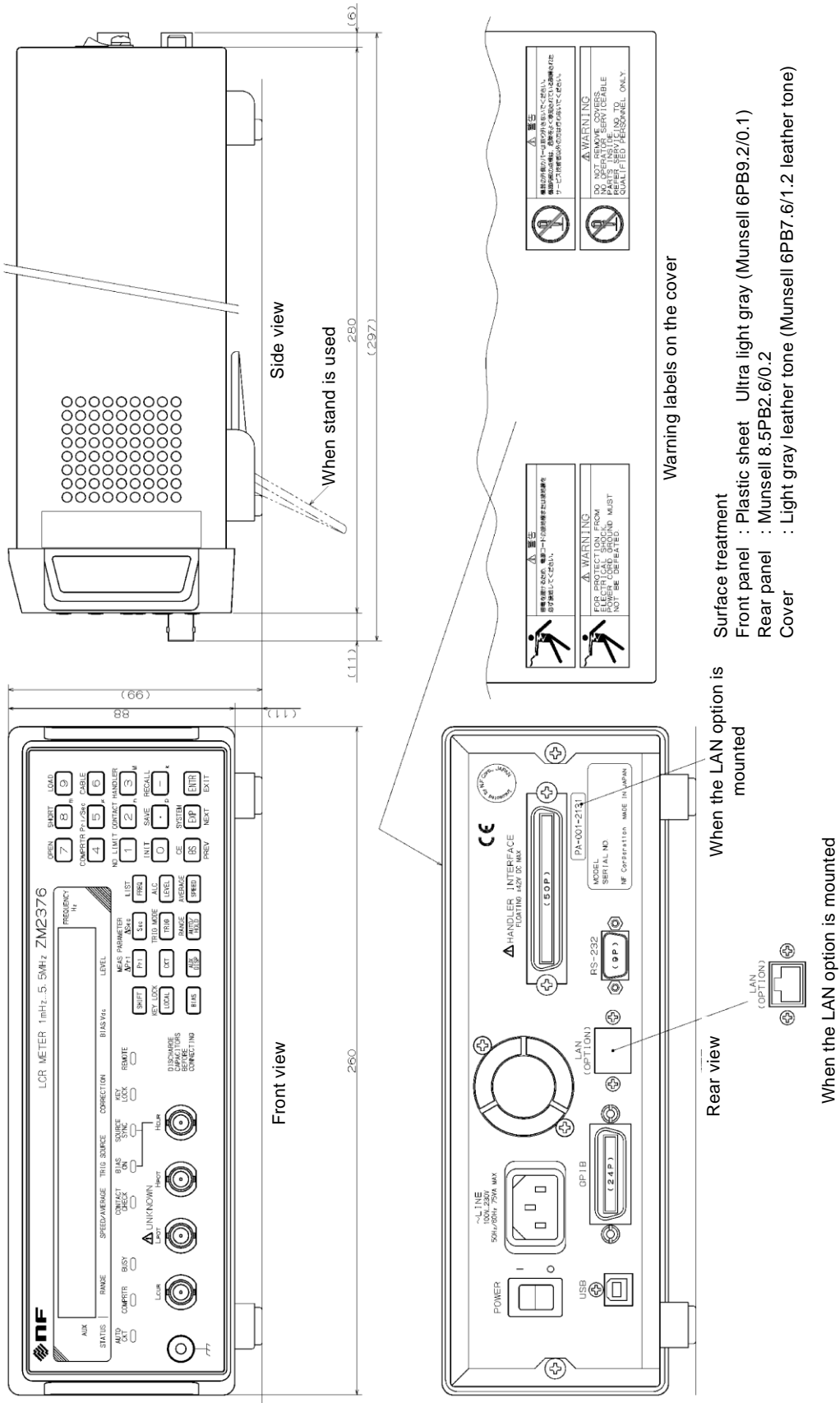

Figure 7-3 ZM2376 external dimensions

WARRANTY

NF Corporation certifies that this product was thoroughly tested and inspected and found to meet its published specifications when it was shipped from our factory.

All **NF** products are warranted against defects in materials and workmanship for a period of one year from the date of shipment. During the warranty period, **NF** will repair the defective product without any charge for the parts and labor. For repair service under warranty, the product must be returned to either **NF** or an agent designated by **NF**. Purchaser shall prepay shipping charge, duties and taxes for the product to either **NF** or the agent from another country, and shipping charge for the return of the product to purchaser shall be paid by **NF** side.

This warranty shall not apply to any defect, failure or damage caused by a) improper use; b) improper or inadequate maintenance and care; or c) modification by purchaser or personnel other than **NF** representatives.

- Failure due to the handling or storage that violates the operating methods or precautions given in the instruction manual
- Failure or damage caused by a fall or shock during transportation or relocation performed by the purchaser
- Modification made to the product by the purchaser
- Failure by external abnormal voltage or influence of external equipment connected to the product
- Failure or damage caused by fire, earthquake, flood, thunder, rebellion, war, and force majeure including other act of providence.
- Replenishment of consumable parts such as magnetic tapes and batteries

REPAIR

When a failure occurred and the product was found to be defective or you have any uncertainty, please get in touch with **NF Corporation** or one of our representatives.

In such a case, let us know the model name (or product name), serial number (SERIAL No. given on the nameplate), and symptom and operating conditions as detail as possible.

Though we will make efforts to reduce the repair period, when five or more years have passed since you purchased the product, it may take time due to, for instance, the out of stock of repair parts.

Also, if the production of repair parts is discontinued, the product is extremely damaged, or the product is modified, we may decline the repair.

NOTES

- Reproduction of the instruction manual, part or whole, is forbidden without prior written permission.
- The contents of the instruction manual are subject to change without notice.
- Information provided in the instruction manual is intended to be accurate and reliable. However, we assume no responsibility for any damage regarding the contents of the instruction manual.

If you have any uncertainty or you found an error or omission, please contact NF Corporation or one of our representatives from which you purchased the product.

ZM2376 Instruction Manual (Basics)

NF Corporation

6-3-20 Tsunashima Higashi, Kohoku-ku, Yokohama
223-8508, JAPAN

Phone: +81-45-545-8128 Fax: +81-45-545-8187

<http://www.nfcorp.co.jp/>

© Copyright 2013 – 2022 **NF Corporation**

