



LOW NOISE AMPLIFIER

SA-250 series

INSTRUCTION MANUAL

DA00087671-001

LOW NOISE AMPLIFIER

SA-250 series
INSTRUCTION MANUAL

———— Preface ————

Thank you for purchasing the “LOW NOISE AMPLIFIER SA-250 series”.

For safe and correct use of this product, please read the “Safety Precautions” section that follows before attempting to use the instrument.

●Marks and symbols

For safe operation by the use and to prevent damage to the instrument, please give attention to the following marks and symbols that are used in this manual.

WARNING

This mark indicates information for preventing the possibility of death or serious personal injury from electrical shock or other hazards or damage to the instrument in the use or handling of this instrument.

CAUTION

This mark indicates information for preventing the possibility of injury to the use or damage to the instrument and the use for handling of this instrument.

●This manual consists of the following chapters.

If using this product for the first time, start from “1. Outline”.

1. Outline

This chapter gives an overview and describes the features and applications of this product and the simple operating principle of the product.

2. Preparation before Use

This chapter describes important preparations to be made before installation and operation.

3. Panel Features and Basic Operations

This chapter explains the basic operations of the panels.

4. Maintenance

This chapter describes a method for simply inspecting operation.

5. Specifications

This chapter gives specifications (functions and performance).

6. Reference Data

This chapter shows the general electrical characteristics of the normal SA-250 series.

————— Safety Precautions —————

To ensure safe use, be sure to observe the following safety precautions.

NF Corporation shall not be held liable for damages that arise from a failure to observe these safety precautions or warnings or cautions in the instruction manual.

- Be sure to observe the information of the instructions manual.

The instruction manual contains information for the safe operation of the product.

Be sure to read the information first before using the product.

All the warnings in the instruction manual are intended for preventing risks that may lead to serious accidents. Ensure to obey them.

- Check the power supply voltage.

This product operates on the power supply voltage indicated in the instruction manual. Prior to connecting the power supply, check that the voltage of the power supply matches the rated power supply of the product.

- If you notice anything strange.

If this product emits smoke, an unusual smell or strange sound, immediately power it off and stop using it.

If such an anomaly occurs, prevent anyone from using this product until it has been repaired, and immediately report the problem to NF Corporation or one of our representatives.

- Do not operate in an explosive atmosphere.

An explosion or other such hazard may result.

- Do not remove the cover.

Never remove the cover.

Even when the inside of this product needs to be inspected, do not touch the inside. All such inspections are to be performed by service technicians designated by NF Corporation.

- Do not modify the product.

Never modify the product. Modification to the product may pose a new risk. We may refuse the repair of a modified product.

- Ensure that water does not get into this product.

Using the product in wet condition may cause electric shock and fire. When water etc. get into the product, immediately power it off, and contact NF Corporation or one of our representatives.

- If lightning occurs, power off and disconnect this product.

A lightning may cause an electric shock, a fire and a failure.

- Safety symbols



Caution, refer to instruction manual.

This notifies the user of potential hazards and indicates that he/she must refer to the instruction manual.



Caution, possibility of electric shock.

This indicates that an electric shock may occur under specific conditions.



Warning

This contains information to avoid risks in equipment handling that could result in loss life or bodily injury.



Caution

This contains information to avoid risks equipment handling that could result in minor or moderate injury to person or damage to property or the equipment.

- Other symbol



This indicates that the terminal or the outer conductor of the connector is connected to the signal ground.

- Disposal of this product

- a) Use the services of an industrial waste disposal contractor for disposal of the entire product.
- b) This product does not include batteries.
- c) This product does not include mercury.

Contents

	Page
Preface.....	i
Safety Precautions.....	ii
1. Outline.....	1-1
1.1 Overview.....	1-2
1.2 Features.....	1-2
1.3 Applications.....	1-3
1.4 Circuit functions.....	1-3
2. Preparation before Use.....	2-1
2.1 Checking before use.....	2-2
2.2 Conditions for installation location.....	2-3
2.3 Power supply.....	2-4
2.3.1 Connecting to low noise DC power supply LP series.....	2-5
2.3.2 Connecting to DC power supply.....	2-6
3. Panel Features and Basic Operations.....	3-1
3.1 Panel component names and functions.....	3-2
3.2 Input / output connection and installation.....	3-4
3.3 Turning on power and warm-up time.....	3-5
4. Maintenance.....	4-1
4.1 Before maintenance.....	4-2
4.2 Dairy maintenance.....	4-2
4.3 Storage, repacking and transportation.....	4-2
4.4 Function test.....	4-3
4.4.1 Consumption Current (with No Signal).....	4-4
4.4.2 Operation check.....	4-4
5. Specifications.....	5-1
5.1 Absolute maximum ratings.....	5-2
5.2 4.2 Electrical characteristics.....	5-2
5.2.1 Input.....	5-2
5.2.2 Output.....	5-2
5.2.3 Amplifier.....	5-2
5.2.4 Power supply.....	5-3
5.2.5 General.....	5-3
5.3 Notes.....	5-3
5.4 External view.....	5-4
5.4.1 SA-250F6.....	5-4
5.4.2 SA-251F6.....	5-4
6. Reference Data.....	6-1
6.1 Reference data.....	6-2
6.2 Voltage gain frequency characteristic.....	6-2

6.3	Voltage gain stability (Temperature)	6-2
6.4	Voltage gain stability (Power supply voltage)	6-3
6.5	Noise figure	6-3
6.6	Equivalent input voltage noise density	6-3
6.7	Equivalent input current noise density	6-4
6.8	PSRR(Power supply rejection ratio)	6-4
6.9	Input VSWR	6-4
6.10	Output VSWR	6-5
6.11	Output 1 dB gain compression point	6-5
6.12	3rd intercept point	6-5
6.13	Pulse response.....	6-6
6.14	Reverse transmission gain frequency characteristics	6-6
WARRANTY		

Figures and Tables

	Page
Figure 1-1 Block diagram.....	1-3
Figure 2-1 Connecting to LP Series power supply.	2-5
Figure 2-2 Connecting to DC Power Supply.....	2-6
Figure 3-1 Front and rear panel views.....	3-3
Figure 4-1 Connection diagram for checking operation	4-4
Figure 4-2 Input voltage waveforms and output voltage waveforms	4-5
Figure 5-1 SA-250F6 external view.	5-4
Figure 5-2 SA-251F6 external view.	5-4
Figure 6-1 Voltage gain frequency characteristic (0.5 V _{p-p} output).	6-2
Figure 6-2 Voltage gain stability (Temperature)	6-2
Figure 6-3 Voltage gain stability (Power supply voltage)	6-3
Figure 6-4 Noise figure.....	6-3
Figure 6-5 Equivalent input voltage noise density.....	6-3
Figure 6-6 Equivalent input current noise density	6-4
Figure 6-7 PSRR.....	6-4
Figure 6-8 Input VSWR.....	6-4
Figure 6-9 Output VSWR.....	6-5
Figure 6-10 1 dB gain compression point.....	6-5
Figure 6-11 3rd intercept point.....	6-5
Figure 6-12 Pulse response (0.2 V _{p-p} , 50 MHz square wave output).....	6-6
Figure 6-13 Pulse response (2 V _{p-p} , 50 MHz square wave output).....	6-6
Figure 6-14 Reverse transmission gain frequency characteristics.....	6-6
Table 2-1 List of contents	2-2

1. Outline

1.1	Overview	1-2
1.2	Features	1-2
1.3	Applications	1-3
1.4	Circuit functions.....	1-3

1.1 Overview

The SA-250 series are low-noise AC amplifiers with a noise figure of 0.9 dB or less.

The voltage gain is 40 dB and the maximum frequency band is 500 MHz, achieving high gain and wideband characteristics.

By applying negative feedback technology, this product, which has both input matching of 50 Ω and low noise characteristics, can be widely used for various applications that require low noise characteristics.

1.2 Features

(1) Low noise

Noise figure:	SA-250F6 0.6 dB
	SA-251F6 0.9 dB

(2) High gain, Wideband

Voltage gain:	40 dB
Frequency band:	SA-250F6 100 Hz to 250 MHz
	SA-251F6 1 kHz to 500 MHz

(3) High stability (Voltage gain)

Temperature dependence:	0.001 dB/°C
Power supply voltage dependence:	0.05 dB/V

(4) Connector with excellent shielding characteristics

Input and output connectors:	SMA connectors
------------------------------	----------------

1.3 Applications

The SA-250 series are high gain, wideband, and low noise. It is widely used for amplification of small signals.

- (1) Preamplifier for the magnetic flux measurement by SQUID sensor, etc.
- (2) Preamplifier for small voltage after voltage conversion of SEM, etc.
- (3) Preamplifier for the sensor such as inertial, pressure, sonic, etc.
- (4) Improvement of noise characteristics for a lock-in amplifier.

1.4 Circuit functions

The SA-250 series are voltage amplifier that amplifies the input voltage with a gain of 40 dB.

The input / output voltage is DC removed by the coupling capacitor. The input impedance is $50\ \Omega$ matched by the equivalent impedance.

The output impedance is $50\ \Omega$.

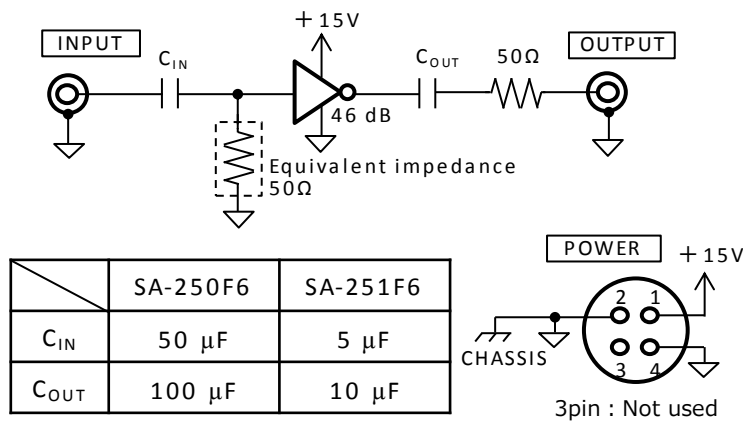

Figure 1-1 Block diagram.

2. Preparation before Use

2.1	Checking before use	2-2
2.2	Conditions for installation location	2-3
2.3	Power supply.....	2-4
2.3.1	Connecting to low noise DC power supply LP series.....	2-5
2.3.2	Connecting to DC power supply.....	2-6

2.1 Checking before use

■ Safety check

Before using this product, read the following section of this manual.

- [Safety Precautions] at the beginning of this instruction manual.
- [2.3 Power supply]

■ Check appearance and accessories

First check for any damage that may have occurred during transportation.

After unpacking the product, refer to “Table 2-1 List of contents” and confirm that all items are present in the quantities listed.

Table 2-1 List of contents

● Main unit	1
● Accessories	
Instruction manual	1
Bottom plate.....	1

* The bottom plate is attached to the main unit by four plastic screws (M3×6 mm).

● Optional Item

Optional items below are separately available. If required, please contact NF or one of our agents.

PA-001-2985: SMA SHORT PLUG

PA-001-2986: SMA-BNC ADAPTER

PA-001-2372: OUTPUT CABLE A (for low noise power supply LP series)

PA-001-3018: POWER SUPPLY CABLE (for DC power supply)

2.2 Conditions for installation location

- The installation location shall meet the following temperature and humidity conditions.

Specifications guaranteed: 18 °C to 28 °C, 5 %RH to 85 %RH

Operating: 0 °C to 40 °C, 5 %RH to 85 %RH

Storage: -10 °C to 50 °C, 5 %RH to 95 %RH

However, do not use the product if condensation is present.

- Use the product indoors at an altitude of up to 2000 m.
- Do not install the product in the following locations:
 - Locations where flammable gases may be present.

There is a risk of explosion. Never install or use the product in such locations.
 - Outdoors, locations exposed to direct sunlight, near fire or heat sources.

The performance may not be satisfied, or a failure may occur.
 - Locations where corrosive gases, water vapor dust, or too humid.

Malfunction or a failure may occur.
 - Near an electromagnetic field source, high-voltage product, or power line.

Noise may increase.
 - Where is a lot of vibration.

Noise may increase, or a malfunction may result.
- For heat dissipation, make sure there is a distance of at least 2 cm between the front panel (the panel on which the model name appears) and surrounding objects.

2.3 Power supply

This product operates under the following power supply conditions.

- Stabilized DC power supply with +15 V \pm 1 V, 100 mA or higher.

Fluctuations in the power supply voltage affect the output signal. That effect is indicated by the PSRR (Power Supply Rejection Ratio) parameter. For example, a PSRR of 60 dB indicates that a power supply fluctuation of 100 mV produces a 0.1 mV fluctuation in the output voltage. The PSRR of this product is 60 dB at 100 kHz, so use of this product with a switching regulator or DC/DC converter that has a large switching noise is not recommended.

For accurate measurement of small signals, use of a DC power supply that has superior stability and noise performance is recommended.

We provide the excellent stability and low noise performance DC power supply LP series. For information on those products, please contact the NF corporation or one of our agents.

 **WARNING**

Do not connect this product to an AC outlet, because doing so is dangerous.

Attention

- Supplying a voltage greater than + 16.5 V will damage this product.
-

2.3.1 Connecting to low noise DC power supply LP series

The OUTPUT CABLE A (PA-001-2372) is available to connect this product to LP series power supply. If you require the cable, please contact NF or one of our agents.

The following figure shows the connection using the OUTPUT CABLE A. The output of LP series power supply is set as ± 15 V.

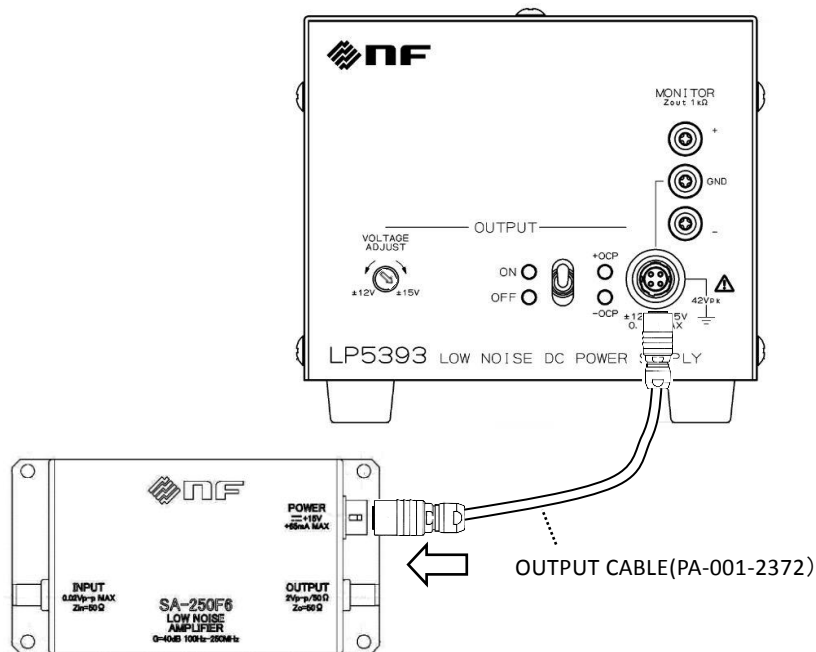

Figure 2-1 Connecting to LP Series power supply.

Attention

- Turn off the output switch of the power supply unit before connecting this product to the power supply unit.
- Do not plug / unplug the output cable A while the power supply is turned on. This product may be damaged.

2.3.2 Connecting to DC power supply

When connecting this product to a stabilized DC power supply, it is convenient to use the PA-001-3018 POWER SUPPLY CABLE that is available for separate purchase. For information on this cable, please contact the NF corporation or one of our agents.

The connection diagram for when the PA-001-3018 POWER SUPPLY CABLE is used is illustrated in the following figure. Set the output voltage of the stabilized DC power supply to +15 V for use with this product. For the connection on the power supply side, the cable has three insulated wires. Strip the insulation from the ends of the wires for connection to the power supply. The power supply output terminals may require that banana plugs, crimped terminals or special connectors be attached to the ends of the wires. Please refer to the instruction manual for the stabilized DC power supply.

Insulated wires

pink : +15 V (AWG24)

black : GND (AWG24)

white : GND (AWG24)

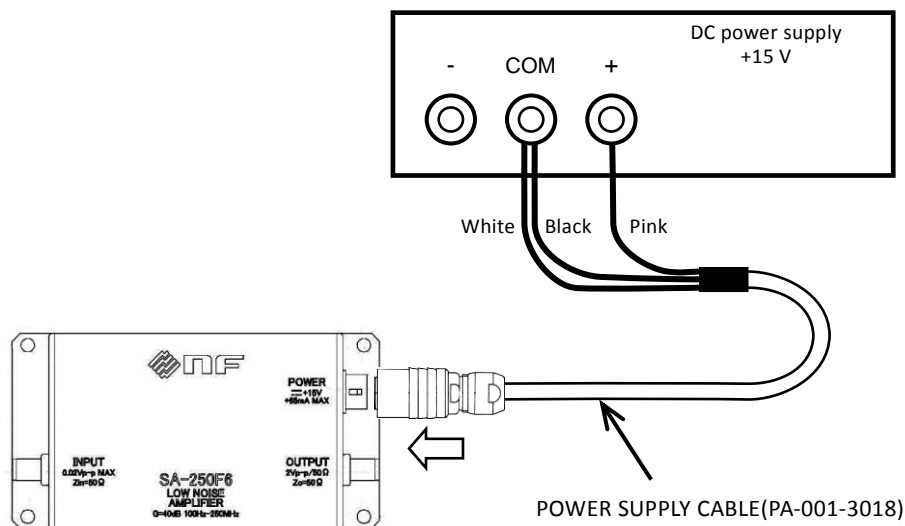

Figure 2-2 Connecting to DC Power Supply.

Attention

- Supplying a voltage greater than + 16.5 V will damage this product.
- Before connecting this product to the power supply, re-check the polarity and voltage of the power supply.
- Do not plug / unplug the power cable while the power supply is turned on. That may result in damage to this product.

3. Panel Features and Basic Operations

3.1	Panel component names and functions	3-2
3.2	Input / output connection and installation.....	3-4
3.3	Turning on power and warm-up time.....	3-5

3.1 Panel component names and functions

See Figure 3-1, Front and rear panel views.

① INPUT

The INPUT is an input connector of this product, and an SMA connector is adopted.
The signal input voltage range is $0.02 V_{p-p}$.

② OUTPUT

The OUTPUT is an output connector of this product, and an SMA connector is adopted.

The output impedance is 50Ω .

The maximum output voltage is $2 V_{p-p}$ (Load: 50Ω).

③ POWER

The POWER is a power input connector of this product, and a HR10-7R-4P(73) is adopted.

Power voltage is + 15 V.

④ Mounting holes

These holes (for M3 screw) are used to mount this product to the chassis, etc. with the bottom plate mounted to it. This product can be mounted to the chassis while they are electrically insulated.

⑤ Holes to mount this product

To remove the bottom plate and mount this product directly to the chassis, etc., use these screw holes (M3) (the length of the screws should be 4 mm or shorter).

Note that if the bottom plate is removed, this product and the object to which this product is mounted are electrically connected. The bottom plate is mounted to this product using 6 mm plastic screws (M3).

3.1 Panel component names and functions

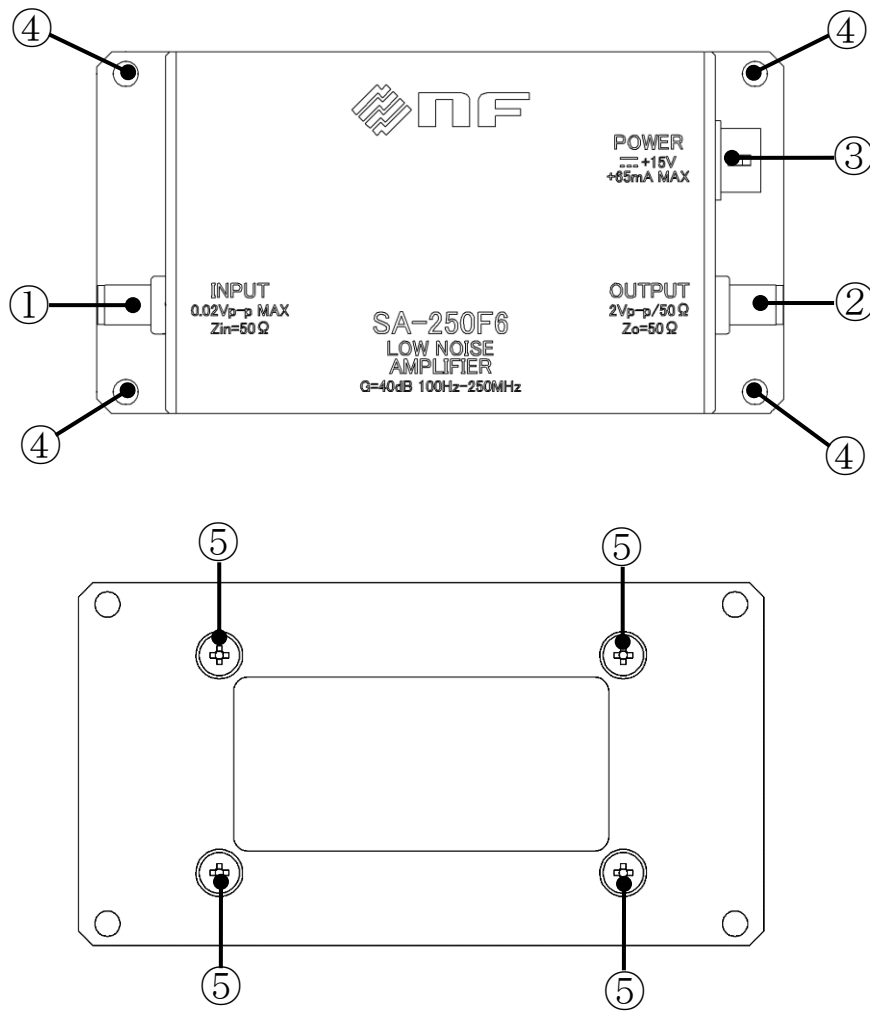

Figure 3-1 Front and rear panel views.

3.2 Input / output connection and installation

The shielding of the input / output cable and the method for connecting and installing the product are important for using this product with the best noise characteristics. Follow the instructions below to connect and install this product.

- Install this product as close as possible to the signal sources such as sensors and make the input cable as short as possible. Even if the product cannot be installed near the sensor or signal source, make the input cable length 2 m or shorter.
- Be sure to use a high-frequency coaxial cable with a characteristic impedance of 50 Ω for input / output connection. Furthermore, install the input cable and output cable as far away from each other as possible (input and output coupling may cause oscillation and instability).
- Longer output cables and power cables are more likely to be affected by external noise and other such factors. The shortest possible cables should be used, but if cable extension is necessary, the cable length should be limited to 2 m.
- Terminate the output with 50 Ω .
- Installing this product with the bottom plate connected to it on conductors, such as metals, insulates the product from the object to which it is connected, so GND loop noise can be reduced.
- If there is a product that includes a transformer, such as a DC power supply, install the sensor and this product as far away as possible from it.
- Install this product in a location where there is as little vibration as possible. For small signal detections, it may be subject to the influence of microphonic noise generated by the vibration of the cable.
- Secure this product in a stable location.

⚠ WARNING

Do not connect this product to an AC outlet, because doing so is dangerous.

Attention

- The signal GND and case have the same electric potential. Caution is required when giving a potential to the case or signal GND because doing so may cause electric shock.
-

3.3 Turning on power and warm-up time

This product exhibits the specified performance immediately after the power is turned on, but if you need highly accurate measurement, allows the device to warm up for at least 10 minutes before use.

4. Maintenance

4.1	Before maintenance	4-2
4.2	Dairy maintenance	4-2
4.3	Storage, repacking and transportation	4-2
4.4	Function test.....	4-3
4.4.1	Consumption Current (with No Signal).....	4-4
4.4.2	Operation check	4-4

4.1 Before maintenance

- This chapter describes the following instructions.
 - Daily maintenance
 - Precautions and storage method when the product is not used for a long period of time
 - Precautions for repacking and transportation
 - Function test that is necessary for periodical inspection, incoming inspection, or function check after repair

If the results of function test are not satisfactory, please contact NF or one of our agents to request calibration or repair.

4.2 Dairy maintenance

- If the panels and cases are dirty
 - Wipe with a soft cloth to clean. To remove stubborn soiling, wipe with a cloth wrung out with neutral detergent.
 - Never use any volatile solvent like thinner, benzene, or a chemical cleaning cloth, as they may cause the surface finish to deteriorate or peel off.

4.3 Storage, repacking and transportation

- Storage when not used for a long period of time
 - Unplug the power supply from this product.
 - Store the product in a location free from falling objects and dust, such as a shelf or rack. If dust may be present, cover the product with a cloth or polyethylene cover.
 - The environmental conditions for storage are -10 to $+50$ °C and 5 to 95 %RH. However, avoid a location where the temperature fluctuates significantly or where the product will be exposed to direct sunlight, and store it in an environment as close to room temperature as possible.
- Repacking and transportation
 - When repacking the product to transport or send it for repairs, pay attention to the following instructions.
 - Wrap the product in a polyethylene bag or sheet.
 - Prepare a cardboard box that can well withstand the weight of the product and is of a large enough size to accommodate it.
 - Fill the cardboard box with a cushioning material so that the six sides of the product can be protected.
 - When making a request for transportation, inform the transport operator that the product is a precision instrument.

4.4 Function test

- The function test is to be executed to confirm failures of this product. This function test is to be executed in the incoming inspection, periodic inspection, and when the function check is required after a repair.

- For the function test, the following instrument devices are required.
 - a) DC power supply
+ 15 V, 100 mA or higher
 - b) Signal generator
200 mV_{p-p} (70.7 mV_{rms}) at 1 MHz sine wave to be output
 - c) Oscilloscope
Frequency band: 100 MHz or higher
 - d) Jigs

BNC coaxial attenuator 20 dB (50 Ω)	×2
SMA to BNC conversion adapter	×2
BNC T type adapter	×1
BNC 50 Ω coaxial terminator	×1
BNC cable (50Ω, 1 m)	×3
Output cable A or DC power cable	×1

- Check the following before the function test.
 - Is the power supply voltage + 15 V within ± 1 V?
 - Is the ambient temperature within 18 to 28 °C, and is the ambient humidity within 5 to 85 %RH?
 - Is there non-condensation?
 - Have 10 minutes or more passed after the power is activated?

4.4.1 Consumption Current (with No Signal)

Check the consumption current if the power supply has a current monitor.

This product is good if the consumption current is as follows when input and output are open.

SA-250F6 45 mA within ± 5 mA

SA-251F6 65 mA within ± 5 mA

4.4.2 Operation check

Make connections as shown in Figure 4-1.

Set the input impedance of the oscilloscope to $1\text{ M}\Omega$.

The signal generator outputs a sine wave with an output voltage of $200\text{ mV}_{\text{p-p}}$ ($70.7\text{ mV}_{\text{rms}}$, Load is $50\ \Omega$) and frequency of 1 MHz . If waveforms like those in Figure 4-2 are displayed on the oscilloscope, this is good.

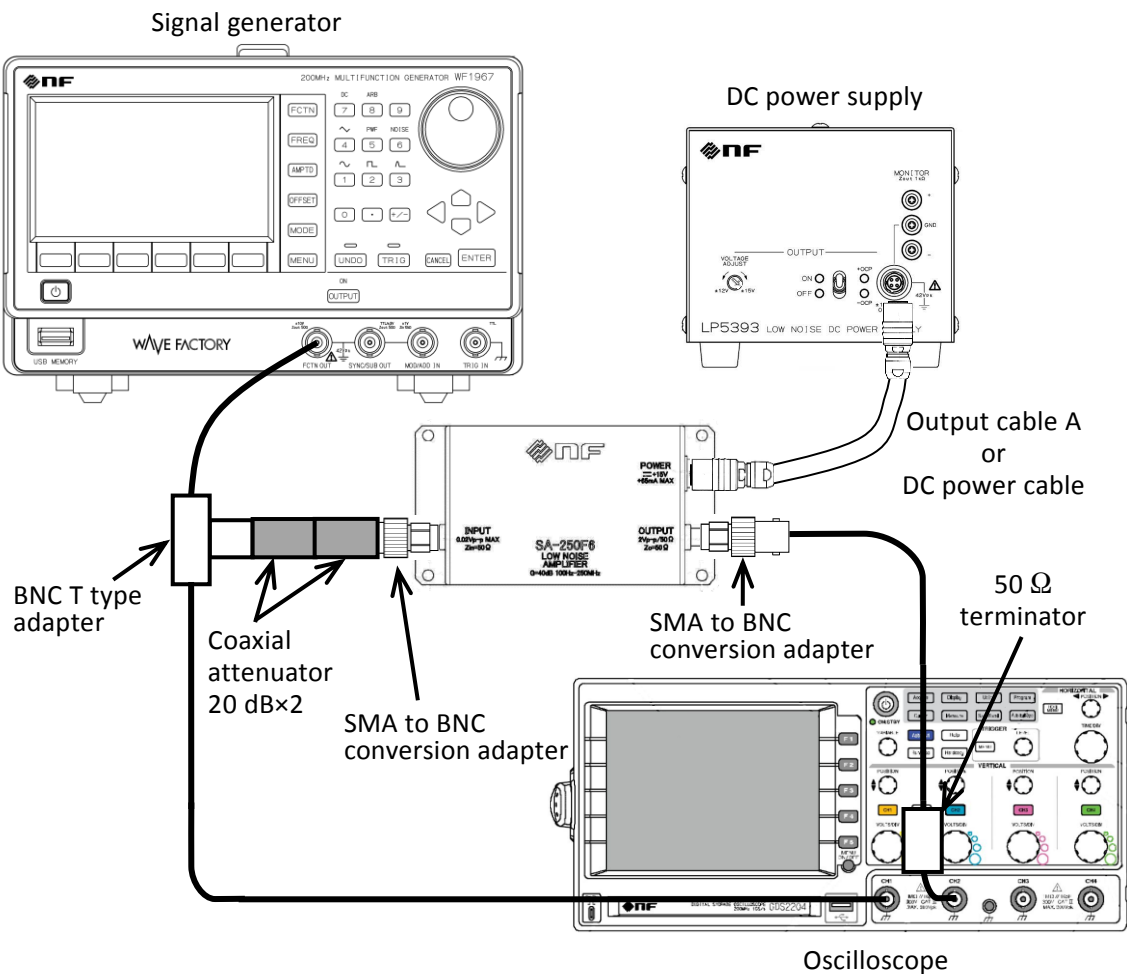

Figure 4-1 Connection diagram for checking operation

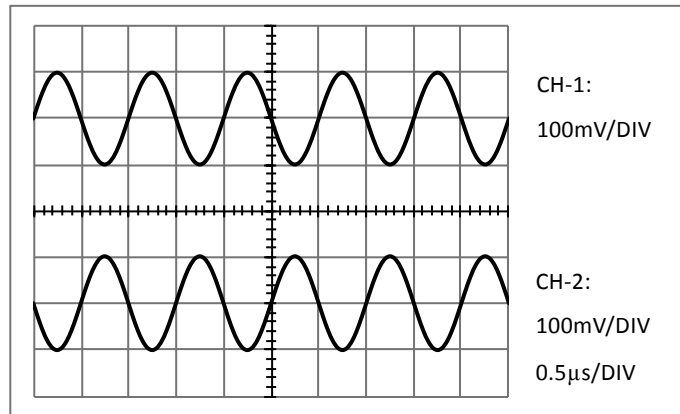

Figure 4-2 Input voltage waveforms and output voltage waveforms

5. Specifications

5.1	Absolute maximum ratings	5-2
5.2	4.2 Electrical characteristics	5-2
5.2.1	Input	5-2
5.2.2	Output.....	5-2
5.2.3	Amplifier	5-2
5.2.4	Power supply.....	5-3
5.2.5	General.....	5-3
5.3	Notes	5-3
5.4	External view	5-4
5.4.1	SA-250F6	5-4
5.4.2	SA-251F6	5-4

Unless otherwise specified, + 15 V (The LP5393: low noise DC power supply, or equivalent is used), load resistance of 50 Ω, and signal source resistance of 50 Ω.

Numerical values that have accuracy ranges indicated (“and above”, “and below”, “within”, etc.) are guaranteed.

The values that do not have accuracy ranges indicated are reference values.

5.1 Absolute maximum ratings

Supply voltage (+ V _s)	+16.5 V
Signal input voltage	± 0.7 V

* If a stress exceeding the above-mentioned absolute maximum rating is applied, permanent damage can be caused to the product.

5.2 4.2 Electrical characteristics

5.2.1 Input

No.	Model	SA-250F6	SA-251F6	Notes
1.1	Input form	AC coupling, unbalanced single-ended input		—
1.2	Input connector	SMA connector		—
1.3	Input impedance	50 Ω		f = 1 MHz
1.4	Signal input voltage range	0.02 V _{p-p} or lower		—
1.5	Input VSWR	1.2 or lower		f = 100 MHz
		2.0	1.6	f = 250 MHz
1.6	Equivalent input noise voltage density	0.25 nV/√Hz		f = 1 MHz, input shorted
1.7	Equivalent input noise current density	5 pA/√Hz	8 pA/√Hz	f = 1 MHz, input opened
1.8	Noise figure	0.6 dB	0.9 dB	f = 10 MHz
		1.0 dB	1.2 dB	f = 250 MHz
			1.8 dB	f = 500 MHz

5.2.2 Output

No.	Model	SA-250F6	SA-251F6	Notes
2.1	Output form	AC coupling, unbalanced single-ended output		—
2.2	Output connector	SMA connector		—
2.3	Maximum output voltage	2.0 V _{p-p}		f = 100 MHz
2.4	Output impedance	50 Ω		f = 1 MHz
2.5	Output VSWR	1.2 or lower		f = 100 MHz
		1.4		f = 250 MHz

5.2.3 Amplifier

No.	Model	SA-250F6	SA-251F6	Notes
3.1	Input / Output phase	Inverted		—
3.2	Voltage gain	40 dB within ± 0.5 dB		f = 1 MHz
3.3	Voltage gain stability	Temperature	0.001 dB/°C	0 °C to 40 °C, f = 1 MHz
		Power supply voltage	0.05 dB/V	+14 V to +16 V, f = 1 MHz
3.4	Voltage gain frequency characteristic	100 Hz to 250 MHz	1 kHz to 500 MHz	Reference frequency of 1 MHz, Within +0.5 dB / -3.0 dB, Output level 0.5 V _{p-p}

5.2.4 Power supply

No.	Model	SA-250F6	SA-251F6	Notes
4.1	Power supply connector	HR10-7R-4P(73), HIROSE Co., Ltd		The matching plug is HR10-7P-4S(73)
4.2	Operating supply voltage range	+15 V within ± 1 V		—
4.3	Consumption current	+ 50 mA	+ 65 mA	No signal
		+ 65 mA or lower	+ 85 mA or lower	Output level $2 V_{pp}$

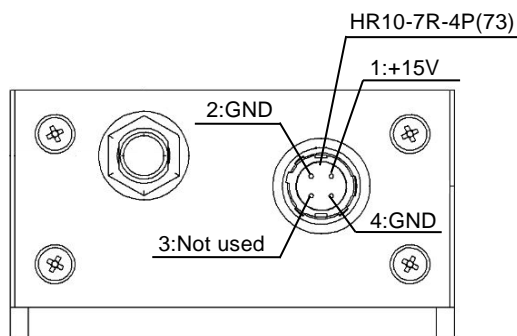

5.2.5 General

No.	Model	SA-250F6	SA-251F6	Notes
5.1	Specified temperature range	23 °C within ± 5 °C		—
5.2	Operating temperature and humidity ranges	0 °C to 40 °C 5 %RH to 85 %RH		Non-condensation
5.3	Storage temperature and humidity ranges	-10 °C to 50 °C 5 %RH to 95 %RH		Non-condensation
5.4	Pollution degree	2		Indoor use
5.5	Altitude	2000 m or lower		—
5.6	External dimensions	76 × 50 × 25 mm		without protrusions and bottom plate
		95 × 50 × 29 mm		without protrusions, with bottom plate
5.7	Weight	Approx. 120 g		without bottom plate
		Approx. 140 g		with bottom plate
5.8	RoHS	Directive 2011/65/EU		—
5.9	EMC	EN61326-1 EN61326-2-1		—

5.3 Notes

- Incorrect voltage polarity of the power supply will damage this product.
- Short circuit of the output terminal is not allowed. Output short circuit or overload drive may damage the internal circuit and deteriorate the performance.
- Use beyond the absolute maximum ratings and operating temperature range may lead to characteristic deterioration or damage on the internal circuit.
- Static electricity may cause characteristic deterioration or damage.

5.4 External view

5.4 External view

5.4.1 SA-250F6

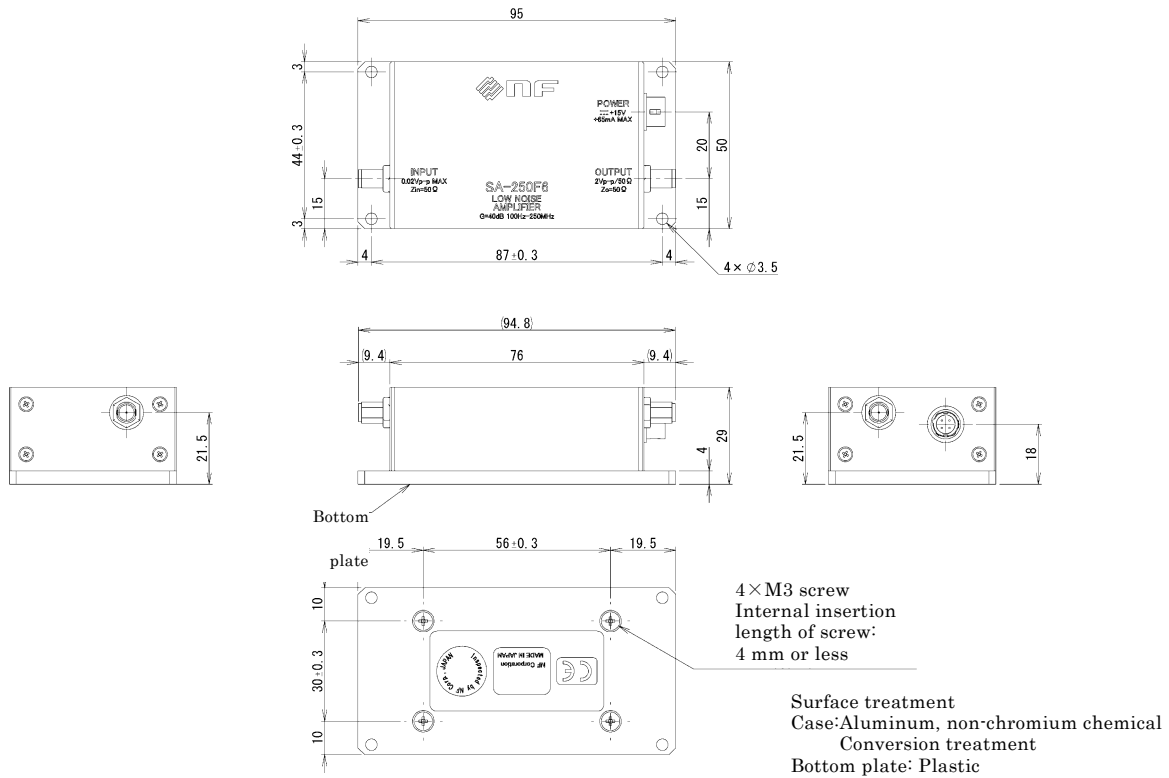

Figure 5-1 SA-250F6 external view.

5.4.2 SA-251F6

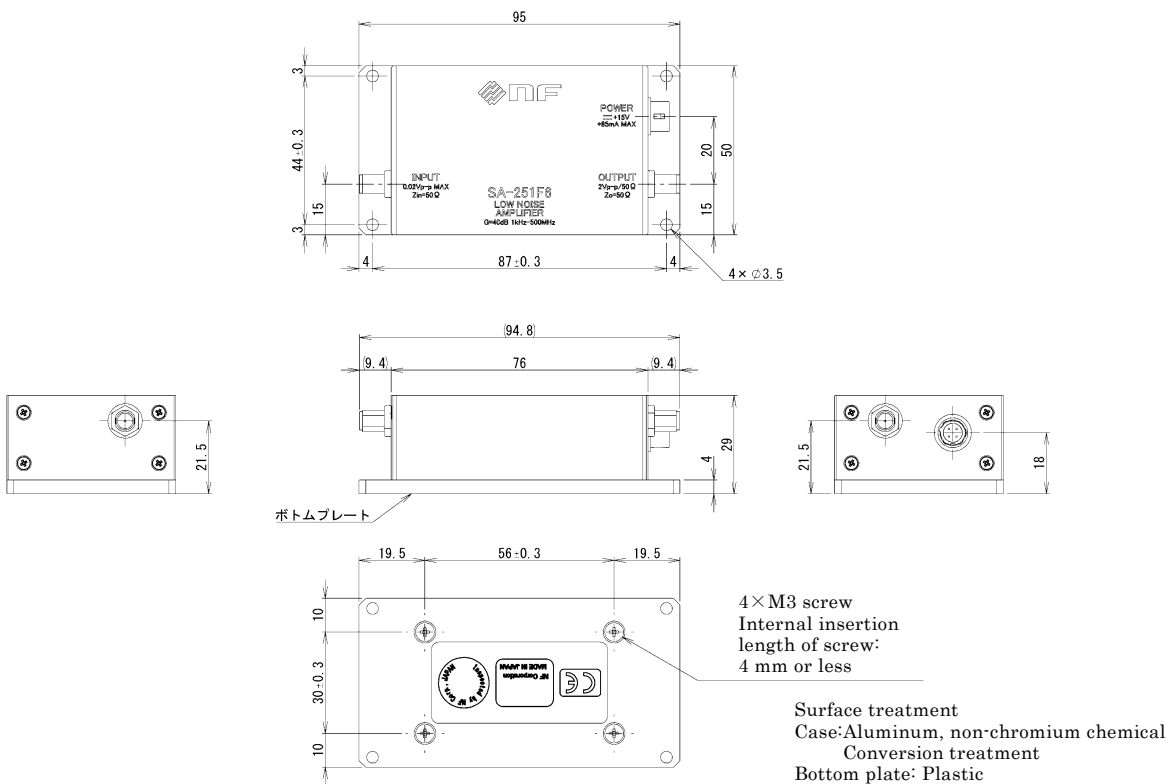

Figure 5-2 SA-251F6 external view.

6. Reference Data

6.1	Reference data.....	6-2
6.2	Voltage gain frequency characteristic	6-2
6.3	Voltage gain stability (Temperature).....	6-2
6.4	Voltage gain stability (Power supply voltage).....	6-3
6.5	Noise figure	6-3
6.6	Equivalent input voltage noise density	6-3
6.7	Equivalent input current noise density	6-4
6.8	PSRR(Power supply rejection ratio).....	6-4
6.9	Input VSWR.....	6-4
6.10	Output VSWR.....	6-5
6.11	Output 1 dB gain compression point	6-5
6.12	3rd intercept point	6-5
6.13	Pulse response.....	6-6
6.14	Reverse transmission gain frequency characteristics	6-6

6.1 Reference data

This chapter shows the reference data of the SA-250 series.

The performance of this product may not achieve the level of these data. However, all products have been strictly tested before shipment to check that they meet the specifications.

Unless otherwise specified, + 15 V (Use LP5393, or equivalent is used), load resistance of 50 Ω , signal source resistance of 50 Ω .

6.2 Voltage gain frequency characteristic

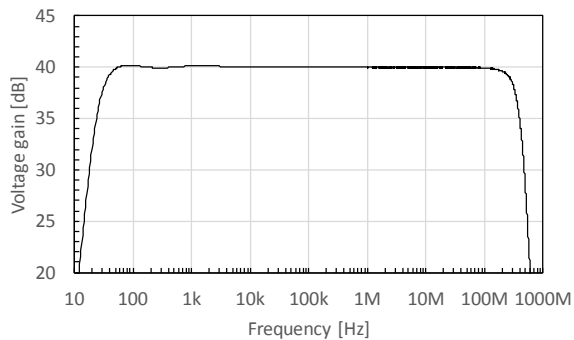

(a) SA-250F6

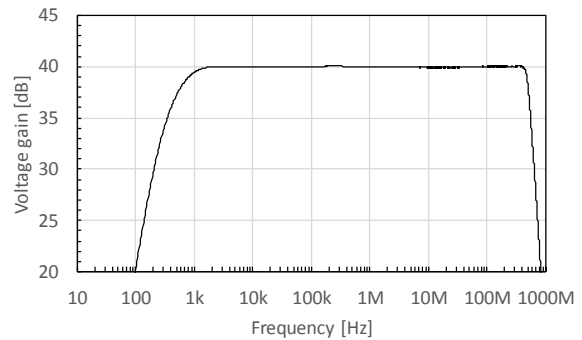

(b) SA-251F6

Figure 6-1 Voltage gain frequency characteristic (0.5 V_{p-p} output).

6.3 Voltage gain stability (Temperature)

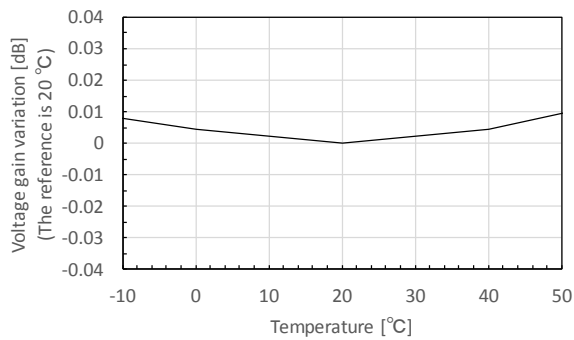

(a) SA-250F6

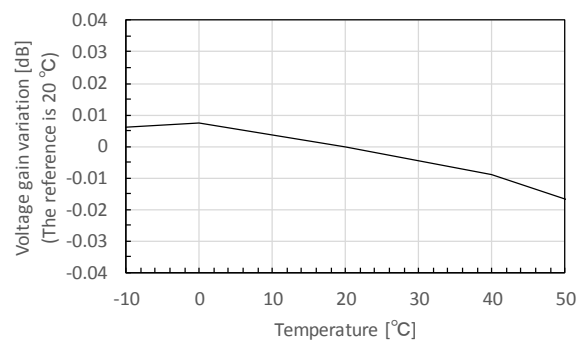

(b) SA-251F6

Figure 6-2 Voltage gain stability (Temperature)

6.4 Voltage gain stability (Power supply voltage)

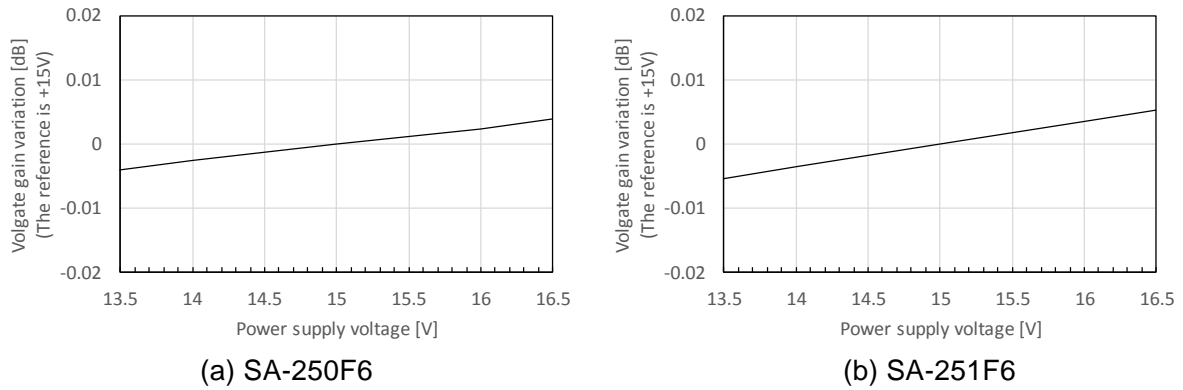

Figure 6-3 Voltage gain stability (Power supply voltage)

6.5 Noise figure

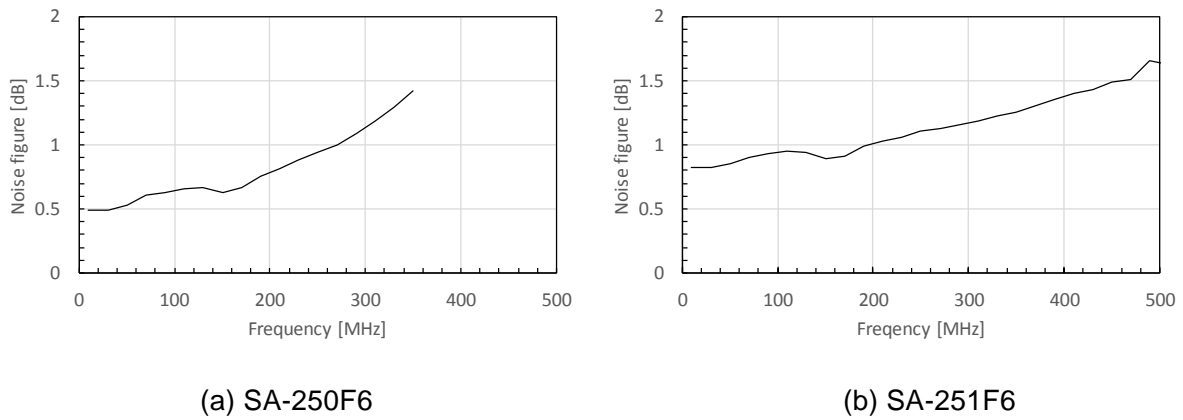

Figure 6-4 Noise figure

6.6 Equivalent input voltage noise density

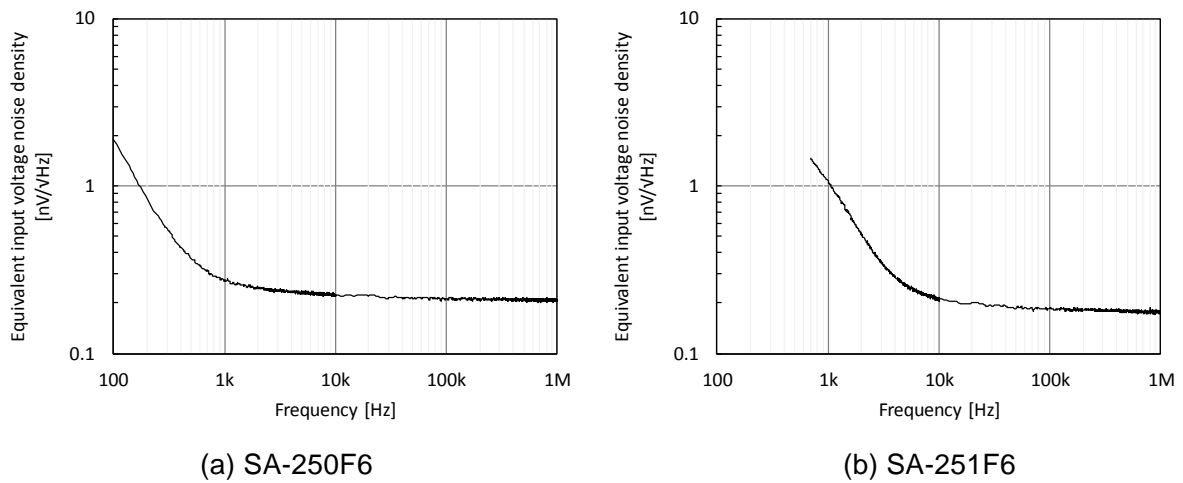
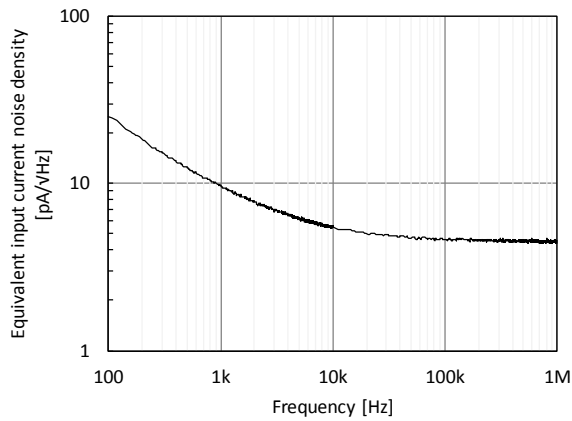
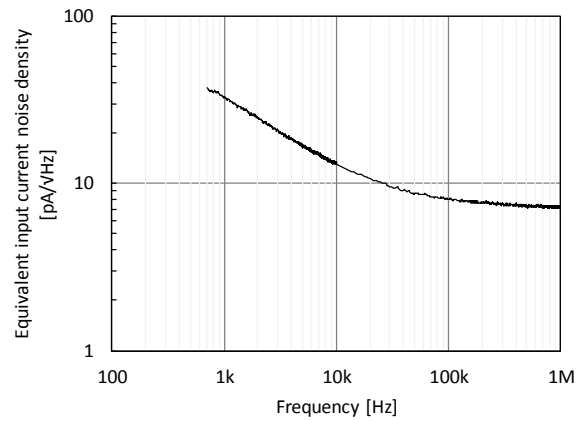

Figure 6-5 Equivalent input voltage noise density

6.7 Equivalent input current noise density



(a) SA-250F6



(b) SA-251F6

Figure 6-6 Equivalent input current noise density

6.8 PSRR(Power supply rejection ratio)

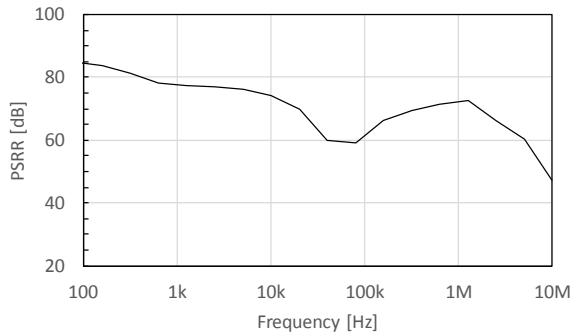

(a) SA-250F6

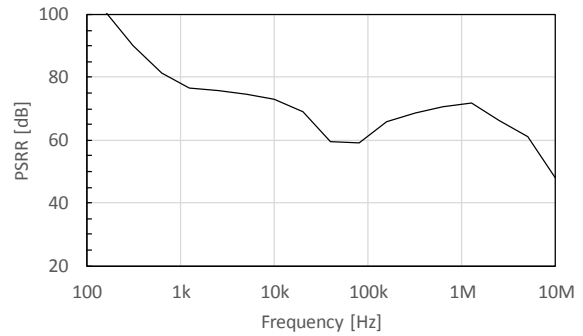

(b) SA-251F6

Figure 6-7 PSRR

6.9 Input VSWR

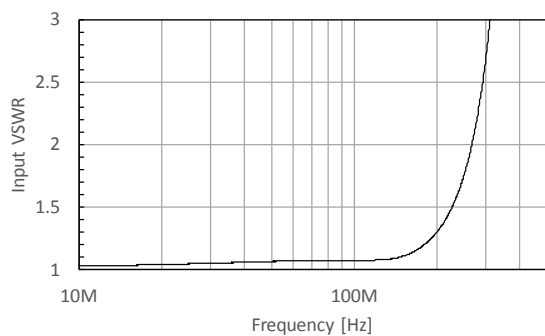

(a) SA-250F6

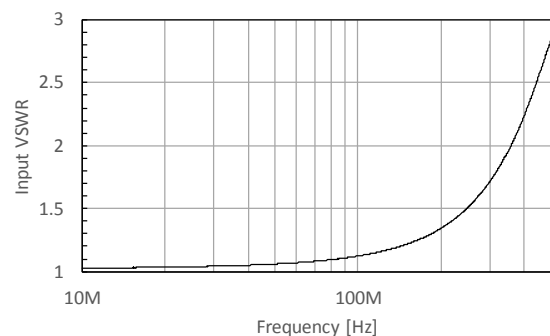

(b) SA-251F6

Figure 6-8 Input VSWR

6.10 Output VSWR

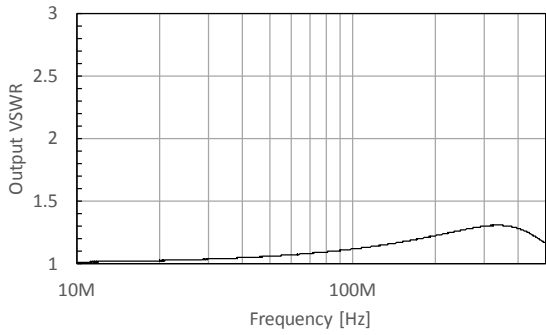

(a) SA-250F6

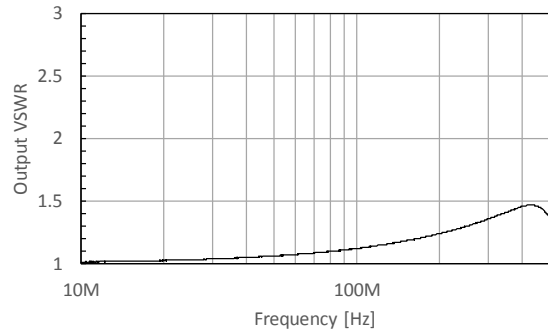

(b) SA-251F6

Figure 6-9 Output VSWR

6.11 Output 1 dB gain compression point

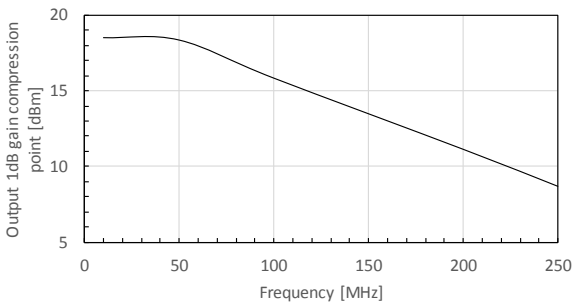

(a) SA-250F6

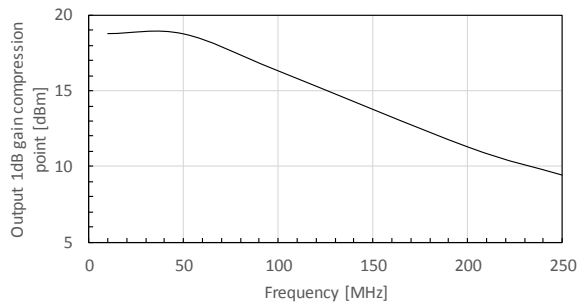

(b) SA-251F6

Figure 6-10 1 dB gain compression point

6.12 3rd intercept point

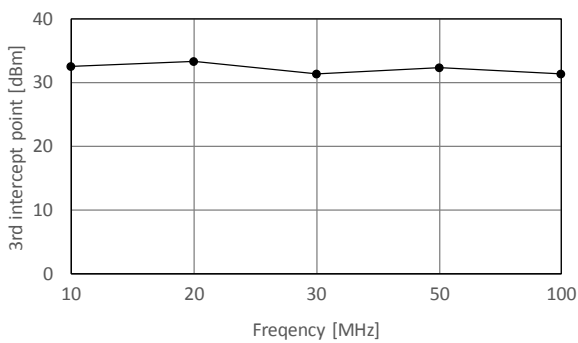

(a) SA-250F6

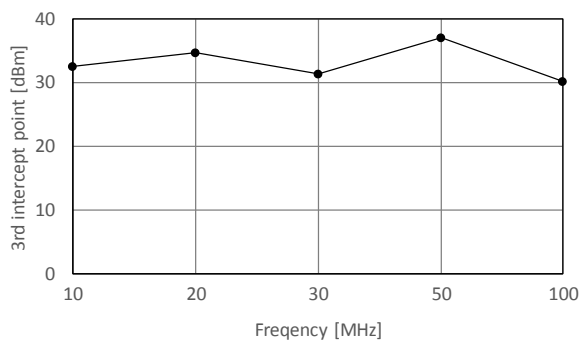

(b) SA-251F6

Figure 6-11 3rd intercept point

6.13 Pulse response

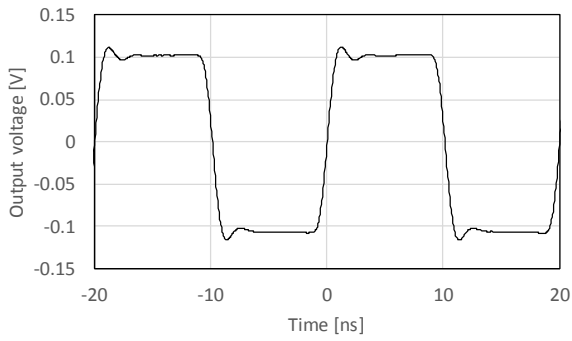

(a) SA-250F6

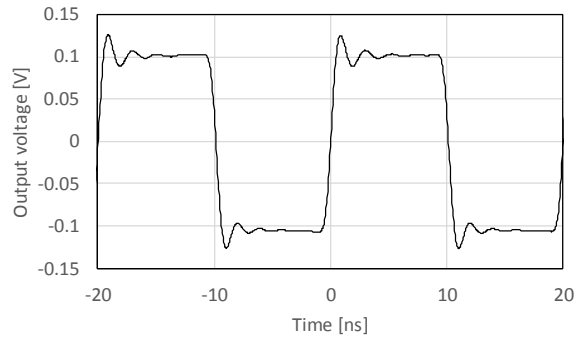

(b) SA-251F6

Figure 6-12 Pulse response (0.2 Vp-p, 50 MHz square wave output)

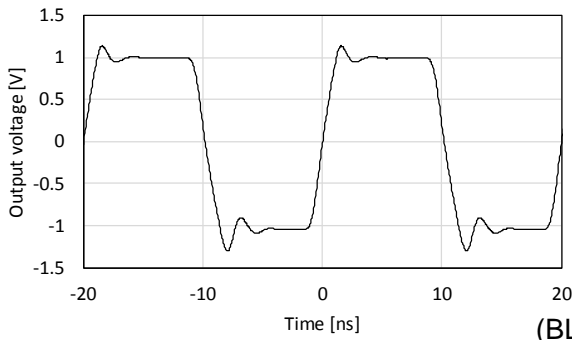

(a) SA-250F6

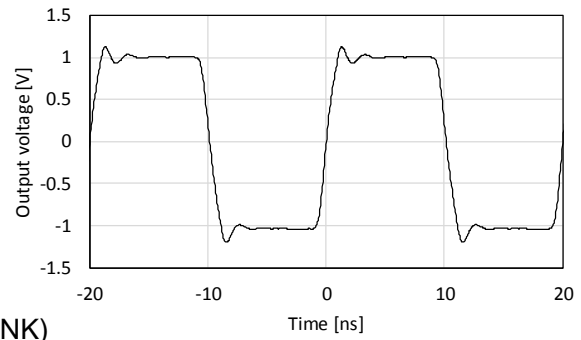

(b) SA-251F6

(BLANK)

Figure 6-13 Pulse response (2 Vp-p, 50 MHz square wave output)

6.14 Reverse transmission gain frequency characteristics

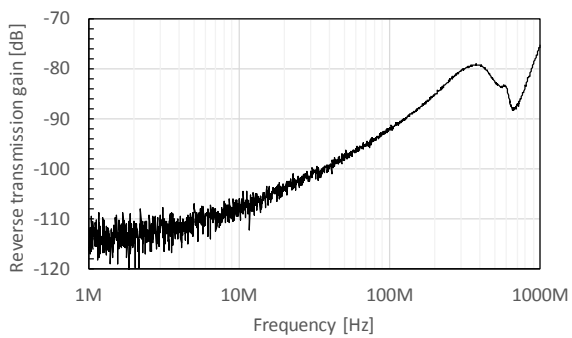

(a) SA-250F6

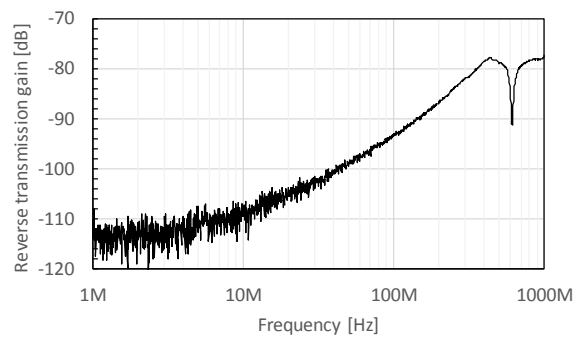

(b) SA-251F6

Figure 6-14 Reverse transmission gain frequency characteristics

WARRANTY

NF Corporation certifies that this product was thoroughly tested and inspected and found to meet its published specifications when it was shipped from our factory. In the unlikely event that you experience an issue during use, please contact our company or agency of our company from which you purchased the product.

All NF products are warranted against defects in materials and workmanship for a period of one year from the date of shipment. During the warranty period, NF will repair the defective product without any charge for the parts and labor.

For repair service under warranty, the product must be returned to either NF or an agent designated by NF. The Purchaser shall prepay all shipping cost, duties and taxes for the product to NF from another country, and NF shall pay shipping charges to return the product to the purchaser.

This warranty shall not apply when corresponding to following particulars.

- A) Failure caused by improper handling or use of the product in a manner that does not conform with the provisions of the Instruction Manual.
- B) Failure or damage caused by transport, dropping, or other handling of the product after purchase.
- C) Failure caused by repair, adjustment, or modification of the product by a company, organization, or individual not approved by NF.
- D) Failure caused by abnormal voltage or the influence of equipment connected to this product.
- E) Failure caused by the influence of supply parts from the customer.
- F) Failure caused by such as corrosion that originate in the use of causticity gas, organic solvent, and chemical.
- G) Failure caused by the insect or small animal that invaded from the outside.
- H) Failure or damage caused by fire, earthquakes, flood damage, lightning, war, or other uncontrollable accident.
- I) Failure caused by the reason that was not able to be foreseen by the science and technology level when shipped from our company.
- J) Replacement and replenishment of consumables such as batteries.

NF Corporation

If there are any misplaced or missing pages, we will replace the manual. Contact the sales representative.

NOTES

- Reproduction of the contents of this manual is forbidden by applicable laws.
- The contents of this manual may be revised without notice.
- Information provided in this manual is intended to be accurate and reliable. However, we assume no responsibility for any damage regarding the contents of this manual.
- We assume no responsibility for influences resulting from the operations in this manual.

Copyright 2021, **NF Corporation**

SA-250 series INSTRUCTION MANUAL

NF Corporation

6-3-20, Tsunashima Higashi, Kohoku-ku, Yokohama
223-8508 JAPAN
Phone +81-45-545-8111 Fax +81-45-545-8191

