



WAVE FACTORY

MULTIFUNCTION GENERATOR

WF1973/WF1974

Instruction Manual (Basics)

DA00016809-004

MULTIFUNCTION GENERATOR

WF1973/WF1974

Instruction Manual (Basics)

Preface

Thank you for purchasing the **WF1973/WF1974 Multifunction Generator**.

To ensure safe and proper use of this electric equipment, please read first **Safety Precautions** on the following pages.

● Caution Symbols Used in This Manual

The following caution symbols are used in this manual. Be sure to observe these caution symbols and their contents to ensure the safety of the user and avoid damage to the equipment.



This mark indicates information for the avoidance of a hazard such as electric shock that may endanger human life or cause injury during handling of the equipment.



This mark indicates information for the avoidance of damage to the equipment during handling.

● This manual has the following chapter organization.

Instruction manuals of the WF1973/WF1974 are divided to two volumes, Basics and Application. Instructions for remote control (GPIB and USB) are provided separately.

If reading this manual for the first time, start from **1. OVERVIEW** of the Basics Instruction Manual.

Basics

1. OVERVIEW

Briefly describes and explains the features and brief operation principles of the WF1973/WF1974.

2. PREPARATIONS BEFORE USE

Describes various cautions regarding preparations to be made before using the WF1973/WF1974, ranging from installation to connection of the power supply.

3. PANELS AND I/O TERMINALS

Describes the functions and operations of the switches and I/O terminals of the panel controls.

4. BASIC OPERATION

Describes how to use basic functions.

5. SAVING AND RECALLING SETTINGS

Describes how to store and retrieve the settings.

6. LIST OF INITIAL SETTINGS

Describes initial settings.

7. SPECIFICATIONS

Lists the specifications (functions and performance) of the WF1973/WF1974.

Application

1. DETAILS OF PARAMETER-VARIABLE WAVEFORMS

Explains the meanings of each parameter of parameter-variable waveforms and waveform examples.

2. CREATING ARBITRARY WAVEFORMS

Explains how to input and edit arbitrary waveforms from the panel control.

3. HANDY USE OF 2-CHANNEL DEVICE (WF1974 ONLY)

Explains how to operate two channels at the same time.

4. SYNCHRONIZING MULTIPLE UNITS

Describes how to configure a multi-phase oscillator by connecting multiple units of this product.

5. USING EXTERNAL FREQUENCY REFERENCE

Describes how to use external frequency reference.

6. USING SEQUENCE OSCILLATION

Describes how to set and operate sequence oscillation.

7. USING USER-DEFINED UNITS

Explains the units that can be optionally set by users.

8. OTHER UTILITY SETTINGS

Explains how to set display and operational details.

9. TROUBLESHOOTING

Explains error messages and how to respond to cases where a failure is suspected.

10. MAINTENANCE

Explains the operational inspection and performance test.

Safety Precautions

To ensure safe use, be sure to observe the following warnings and cautions.

NF Corporation shall not be held liable for damages that arise from a failure to observe these warnings and cautions.

This product is a Class I product (with protective conductor terminal) that conforms to the JIS and IEC insulation standards.

● Be sure to observe the contents of this instruction manual.

This instruction manual contains information for the safe operation and use of this product. Be sure to read this information first before using this product.

All the warnings in the instruction manual must be heeded to prevent hazards that may cause major accidents.

● Be sure to ground the product.

This product uses a line filter and must be grounded to avoid the risk of electric shock.

To prevent electric shock, be sure to safely implement grounding such that ground resistance is 100 Ω or lower.

The WF1973/WF1974 is automatically grounded when the 3-prong power plug is connected to a 3-prong power outlet with a protective grounding contact.

This product does not come with a 3-prong to 2-prong conversion adapter. When using a separately sold 3-prong to 2-prong conversion adapter, be sure to connect the (green) grounding wire of the adapter to the grounding terminal next to the outlet.

● Check the power supply voltage.

This product operates on the power supply voltage shown in **2.3 Grounding and Power Supply Connection** in the Basics Instruction Manual.

Prior to connecting the power supply, check that the voltage of the power supply matches the rated power supply of the product.

● In case of suspected anomaly

If this product emits smoke, an abnormal smell, or abnormal noise, immediately power it off and stop using it.

If such an anomaly occurs, do not use this product until it has been repaired, and immediately report the problem to the location of purchase (either NF Corporation or your distributor).

● Do not use this product when gas is present.

An explosion or other such hazard may result.

● Do not remove the cover.

This product contains high-voltage parts. Absolutely never remove its cover.

Even when the inside of this product needs to be inspected, do not touch the inside. All such inspections are to be performed by service technicians designated by NF Corporation.

● Do not modify this product.

Absolutely never modify this product, as this may cause new hazards and may disqualify this product from repair in case of failure.

● Safety-related symbols

The general definitions of the safety-related symbols used on this product and in the instruction manual are provided below.



Instruction Manual Reference Symbol

This symbol is displayed to alert the user to potential danger and refer him/her to the instruction manual.



Electric Shock Danger Symbol

This symbol indicates locations that present a risk of electric shock under specific conditions.



Warning Symbol

This symbol indicates information for avoiding danger to human life or bodily injury while handling this product.



CAUTION Caution Symbol

This symbol indicates information for preventing damage to the product when handling it.

● Other symbols



This symbol indicates that the external conductor of the connector is connected to the case.



This symbol shows that the external conductor of the connector is insulated from the case.

It shows, however, that the potential difference from the grounding potential is restricted to 42 Vpk or lower for safety. (Since this product is grounded when used, the potential of the case equals the grounding potential.)

● Waste disposal

To help ensure environmental protection, use a professional industrial waste contractor to dispose of this product. A battery is not used for this product.

Contents

Preface	I
Safety Precautions.....	III
Contents	V
Figures and Tables	VIII
1. OVERVIEW	1
1.1 Features.....	1
1.2 Operating Principles	2
2. PREPARATIONS BEFORE USE	4
2.1 Checking Before Use.....	4
2.2 Installation.....	5
2.3 Grounding and Power Supply Connection.....	6
2.4 Calibration.....	7
3. PANELS AND I/O TERMINALS.....	8
3.1 Panel Components and Operations.....	8
3.1.1 Front panel of WF1973	8
3.1.2 Rear panel of WF1973.....	9
3.1.3 Front panel of WF1974	10
3.1.4 Rear panel of WF1974	11
3.2 I/O Terminals	12
3.2.1 Waveform output (FCTN OUT)	12
3.2.2 Sync/sub-output (SYNC/SUB OUT).....	13
3.2.3 External modulation/addition input (MOD/ADD IN)	14
3.2.4 External trigger input (TRIG IN)	14
3.2.5 External 10 MHz frequency reference input (10 MHz REF IN)	15
3.2.6 Frequency reference output (REF OUT).....	16
3.2.7 Multi-I/O (MULTI I/O).....	16
3.3 Cautions on Floating Ground Connection.....	19
4. BASIC OPERATION.....	21
4.1 Power on/off Switching and Restoration of Settings.....	21
4.1.1 Power on/off switching method	21
4.1.2 Restoration of settings at power-on	22
4.2 Screen Configuration and Operation	25
4.2.1 Screen configuration	25
4.2.2 Switching display format with tabs (displaying waveform graph).....	27
4.2.3 Top menu	29
4.3 Basic Settings and Operations	30

4.3.1	Changing the frequency, amplitude, and other values.....	30
4.3.2	Changing the waveform and oscillation mode	33
4.3.3	Manipulating shortcut keys for changing basic parameters	34
4.3.4	Operations of ENTER key, CANCEL key, and UNDO key	35
4.3.5	Changing the display unit.....	36
4.3.6	CH1/CH2 switching key and active channel (WF1974 only).....	38
4.3.7	Actions possible in the Utility screen.....	39
4.3.8	Restoring the initial settings	41
4.3.9	Output on/off	41
4.4	Setting Methods for Main Items	43
4.4.1	Configuration of text display screen in continuous oscillation mode	43
4.4.2	Setting the oscillation mode	43
4.4.3	Setting the waveform	44
4.4.4	Setting the frequency	44
4.4.5	Performing setting with period.....	45
4.4.6	Setting the phase	45
4.4.7	Setting the amplitude	48
4.4.8	Setting DC offset.....	50
4.4.9	Setting the output level with high level/low level	51
4.4.10	Setting the waveform polarity and amplitude range	52
4.4.11	How to use auto range/range hold for the output voltage	54
4.4.12	Setting the load impedance.....	55
4.4.13	Adding external signal.....	57
4.4.14	Setting the square wave duty.....	59
4.4.15	Setting the pulse width and leading/trailing edge time of a pulse wave	61
4.4.16	Setting the ramp wave symmetry.....	64
4.5	Using Parameter-Variable Waveforms	65
4.6	Using Arbitrary Waveforms.....	67
4.7	Modulation Setting and Manipulation.....	69
4.7.1	Modulation types	69
4.7.2	Screen for modulation setting and manipulation	70
4.7.3	Common modulation settings and manipulations	72
4.7.4	Setting FM.....	75
4.7.5	Setting FSK.....	76
4.7.6	Setting PM.....	77
4.7.7	Setting PSK.....	78
4.7.8	Setting AM.....	79
4.7.9	Setting AM (DSB-SC).....	80
4.7.10	Setting DC offset modulation	81
4.7.11	Setting PWM	82
4.8	Sweep Setting and Manipulation	83
4.8.1	Sweep types.....	83
4.8.2	Screen for sweep setting and manipulation	83

4.8.3	Common sweep settings and manipulations.....	86
4.8.4	Setting frequency sweep.....	95
4.8.5	Setting phase sweep.....	97
4.8.6	Setting amplitude sweep.....	99
4.8.7	Setting DC offset sweep.....	101
4.8.8	Setting duty sweep.....	103
4.9	Burst Setting and Manipulation.....	105
4.9.1	Burst oscillation types.....	105
4.9.2	Auto burst.....	106
4.9.3	Trigger burst.....	109
4.9.4	Gate oscillation.....	113
4.9.5	Triggered gate oscillation.....	118
5.	SAVING AND RECALLING SETTINGS.....	122
5.1	Saving Settings.....	122
5.2	Recalling Settings.....	124
6.	LIST OF INITIAL SETTINGS.....	126
7.	SPECIFICATIONS.....	129
7.1	Oscillation Modes.....	129
7.2	Waveforms.....	129
7.2.1	Standard waveforms.....	129
7.2.2	Arbitrary waveforms.....	129
7.3	Frequency, Phase.....	130
7.4	Output Characteristics.....	130
7.4.1	Amplitude.....	130
7.4.2	DC offset.....	130
7.4.3	Load impedance setting.....	131
7.4.4	Waveform output.....	131
7.4.5	Sync/sub output.....	131
7.5	Signal Characteristics.....	131
7.5.1	Sine wave.....	131
7.5.2	Square wave.....	132
7.5.3	Pulse wave.....	132
7.5.4	Ramp wave.....	133
7.5.5	Parameter-variable waveforms.....	133
7.6	Modulated Oscillation Mode.....	136
7.6.1	General.....	136
7.6.2	Modulation conditions.....	137
7.7	Sweep Oscillation Mode.....	138
7.7.1	General.....	138
7.7.2	Sweep conditions.....	139

7.8	Burst Oscillation Mode.....	139
7.9	Triggers.....	140
7.10	Sequence.....	141
7.11	Other I/Os	142
7.12	2-channel ganged operation (WF1974 only)	143
7.13	Synchronous Operation of Multiple Units	144
7.14	User-Defined Units	144
7.15	Other Functions	145
7.16	Options	145
7.17	General Characteristics	145
■	External dimensions (WF1973)	147
■	External dimensions (WF1974)	148
RACK MOUNTING DIMENSIONS		149
■	Inch rack mounting dimensions (for 1 unit).....	149
■	Inch rack mounting dimensions (for 2 units).....	150
■	Millimeter rack mounting dimensions (for 1 unit)	151
■	Millimeter rack mounting dimensions (for 2 units).....	152
Index.....		153
WARRANTY		157

Figures and Tables

Figure 3-1.	Front Panel of WF1973.....	8
Figure 3-2.	Rear Panel of WF1973	9
Figure 3-3.	Front Panel of WF1974.....	10
Figure 3-4.	Rear Panel of WF1974	11
Figure 3-5.	Multi-I/O Connector Pin Assignment.....	17
Figure 3-6.	Cautions on Floating Ground Connection for WF1973.....	20
Figure 3-7.	Cautions on Floating Ground Connection for WF1974.....	20
Table 3-1.	Signals Selectable for Sync/Sub-Output.....	13
Table 3-2.	Multi-I/O Connector Function Allocation.....	18

1. OVERVIEW

1.1 Features

The WF1973 and WF1974 are multifunctional generators based on direct digital synthesizers (DDS).

The WF1973 is a 1-channel generator, while the WF1974 is a two-channel generator.

- Highest frequency: 30 MHz (sine wave), 15 MHz (square wave, pulse)
- Frequency accuracy: $\pm(3 \text{ ppm} + 2 \text{ pHz})$, high resolution of 0.01 μHz . 10 MHz external frequency reference can be used.
- Maximum output voltage: 20 V_{p-p}/open, 10 V_{p-p}/50 Ω
- Large number of standard parameter-variable waveforms: Sine wave, square wave (variable duty), pulse (variable pulse width/duty, leading edge time, trailing edge time), ramp wave (variable symmetry), CF controlled sine wave (variable crest factor), staircase sine wave (variable number of steps), Gaussian pulse (variable σ), Sin(x)/x (variable number of zero crossings), exponential rise/fall (variable time constant), damped oscillation (variable oscillation frequency, damping time constant), pulse surge (variable rising and duration times), trapezoid (variable rise, fall, and upper base width), and so on.
- Large-capacity arbitrary waveform memory: 512 K words max., saving capacity: 128 waveforms/4 M words
- Phase and waveform remain continuous even when frequency is changed or during frequency sweep.
- Square wave, pulse with variable duty and high resolution of 0.0001%
- Pulse with variable leading edge time and trailing edge time
- Various oscillation modes
 - Continuous oscillation
 - Modulation: FM, FSK, PM, PSK, AM, DC offset modulation, PWM
 - Sweep: Frequency, phase, amplitude, DC offset, duty
 - Burst oscillation: Auto burst, trigger burst, gate oscillation, triggered gate oscillation
 - Sequence oscillation: Variable waveform/ frequency/ phase/ amplitude/ DC offset/ square wave duty, constant value/ linear interpolation, jump/ repeat/ hold/ branch
- Sequence function for easy test waveform creation and adjustment
Flexible waveform creation possible through combination with standard parameter-variable waveforms
Frequency, phase, amplitude, etc., can be rapidly changed and swept
- Intuitive user interface through use of high-resolution QVGA TFT color LCD
- Two-channel ganged function with 2 phases, constant frequency difference, constant frequency ratio, and differential output (only WF1974)
- Floated from housing for each channel to reduce effect of ground loop
- Multiple-phase oscillator can be configured by synchronizing multiple units
- USB and GPIB interfaces provided
- Thin and lightweight: Height of approx. 9 cm, weight of approx. 2.1 kg

1.2 Operating Principles

■ WF1973 block diagram

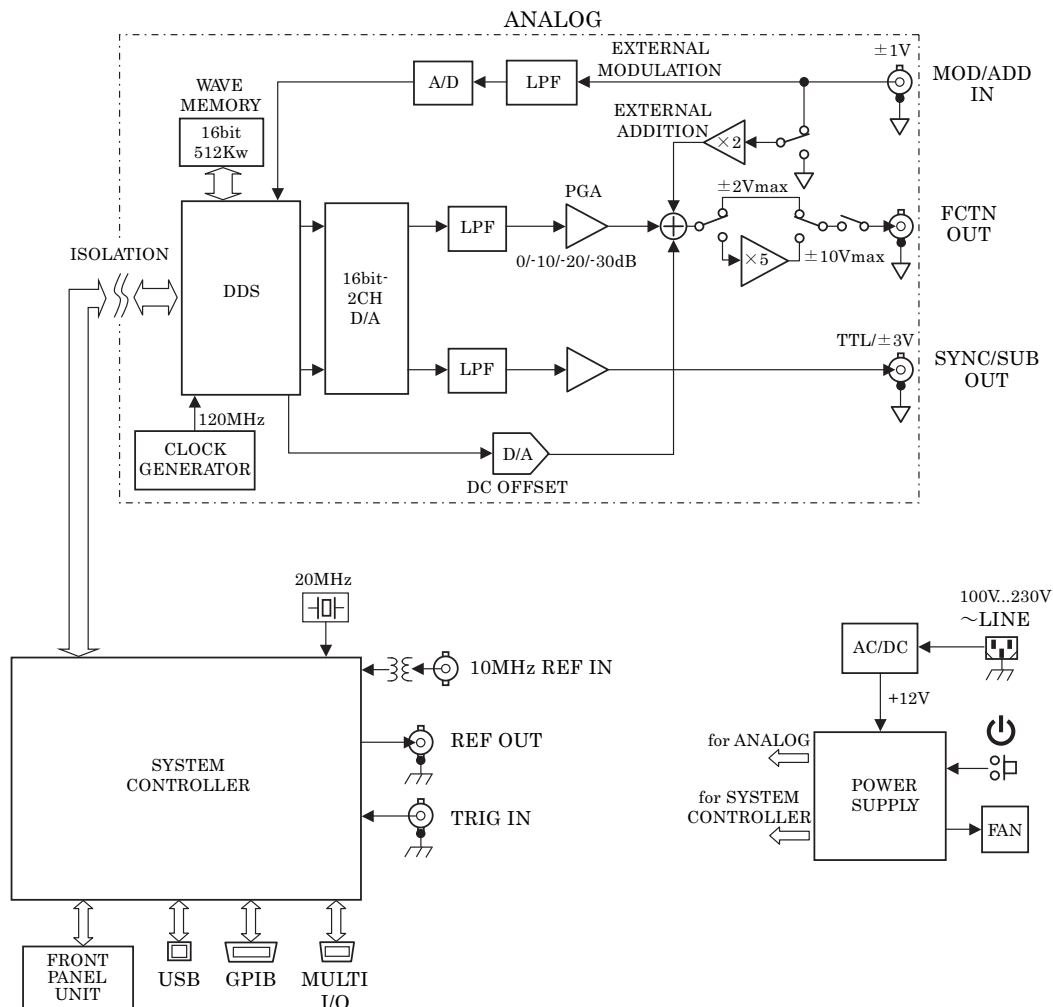

■ Analog block

- The DDS (digital direct synthesizer) uses a 120 MHz clock to generate various types of oscillation and waveforms. Modulation, sweep, burst, and sequence are also processed within the DDS.
- The digital waveforms generated by the DDS are controlled to the specified polarity (normal, inversed) in the amplitude range ($-FS/0$, $\pm FS$, $0/+FS$), and following digital amplitude adjustment, the signal is input into the digital to analog (D/A) converter.
- The waveform converted into an analog signal by the D/A is then smoothed by the lowpass filter (LFP), and the amplitude is controlled in 10 dB steps by the programmable gain amplifier (PGA).
- The external addition signal and DC offset are added to the PGA output. When an output voltage exceeding $\pm 2V$ /open is required, output is done via the $\times 5$ amplifier.
- The maximum output voltage of the product is either 20 Vp-p or 4 Vp-p depending on whether or not the $\times 5$ amplifier is used. Also depending on this, the external addition gain is either $\times 10$ or $\times 2$.
- After passing through the LPF, the external modulation signal undergoes A/D conversion and is then input to the DDS.

WF1974 block diagram

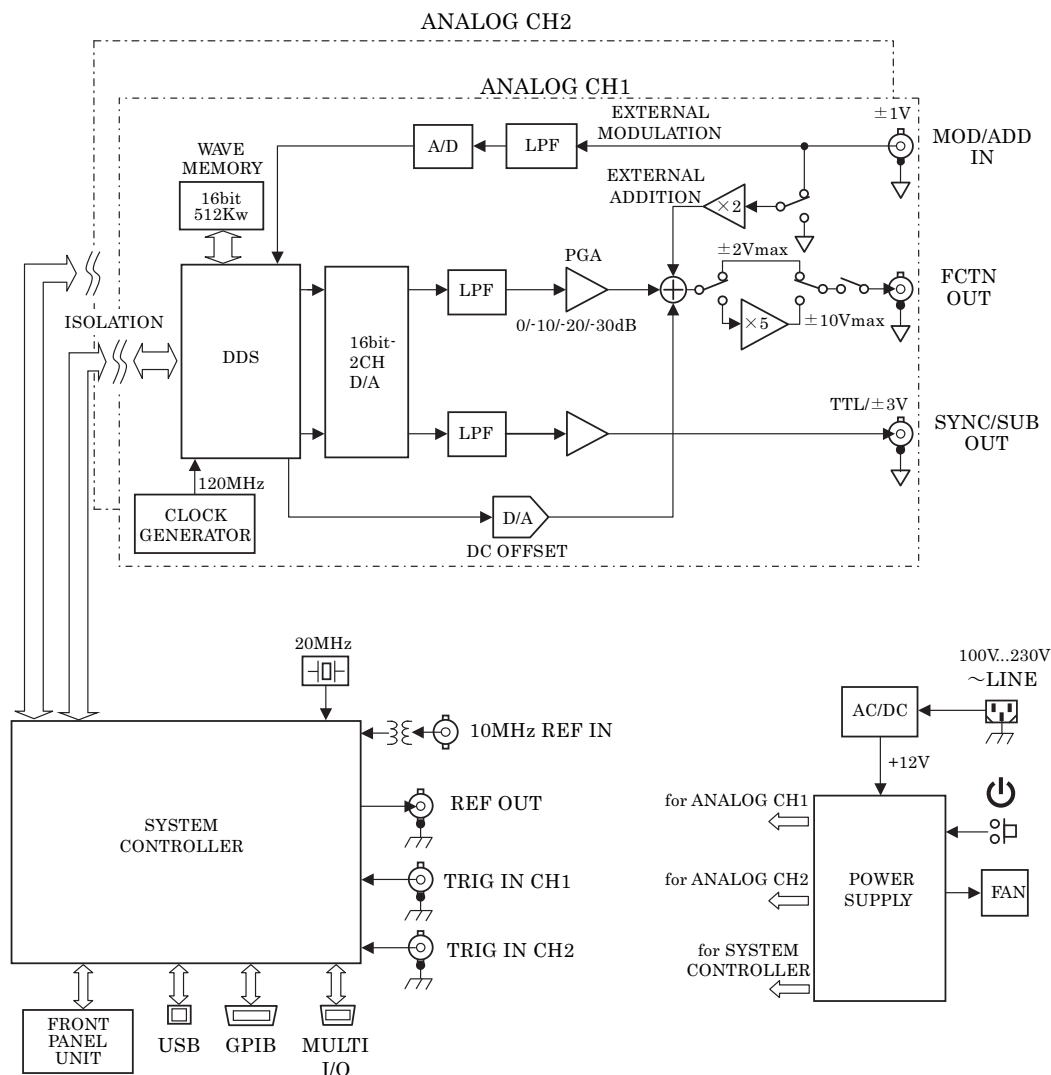

- The analog block is insulated from the system controller block located in the housing potential.
- In the WF1974, the analog block comprises two channels, each individually isolated from the housing potential.

System controller block

- This block performs control of the analog block, including the display, panel key processing, remote control (GPIB, USB) processing, trigger input processing, frequency reference control, DDS control, amplitude, and DC offset.
- A 20 MHz crystal oscillator is used as the basic oscillation of the DDS.
- The signal to synchronize multiple units is sent to REF OUT (frequency reference output), and the inter-channel sync (WF1974 only) is sent to the analog block of each channel.

Power supply block

- The AC/DC directly connected to the power supply input is in a constantly powered state.
- Control of each power supply circuit is done through power switch manipulation.

2. PREPARATIONS BEFORE USE

2.1 Checking Before Use

a) Safety check

To ensure safety in using the WF1973/WF1974, the user should read the following sections of this instruction manual before using the WF1973/WF1974:

- **Safety Precautions** (provided at the beginning of this instruction manual)
- **2.3 Grounding and Power Supply Connection**

b) Appearance and accessories check

If an abnormality (such as a flaw or dent) is found on the outside surface of the corrugated box, carefully check if the product is adversely affected when removing the product from the corrugated box.

After opening the corrugated box, check the items contained in the box.

If an abnormality such as a flaw or dent is found on the product, or an accessory is missing, contact NF Corporation or its representative.

- **Appearance check**

Check that no abnormalities such as a flaw and dent are found on the panel, controls, connectors, and so forth.

- **Configuration and accessory check**

The accessories of this product are listed below. Check that there are no missing items and no flaws are found.

Main unit.....	1
Instruction Manual (Basics).....	1
CD (PDF instruction manuals, application software)	1
PDF instruction manuals:	
Basics, Application, Remote Control,	
Arbitrary Waveform Editing Software, Sequence Editing Software,	
LabVIEW Driver	
Application software:	
Arbitrary Waveform Editing Software, Sequence Editing Software,	
LabVIEW Driver	
Power cord set (2 m, with 3-prong plug).....	1



WARNING

This product contains high-voltage parts. Never remove the cover. All internal inspections of this product are to be performed only by service technicians qualified by NF Corporation.

c) Repacking

When repacking this equipment for transportation, etc., use a shipping carton of sufficient strength and capacity to safely accommodate the equipment and hold its weight.

d) Options

The following options are available and can be purchased separately.

- Multi-I/O cable (PA-001-1318)

This cable is used when using the multi-I/O connector on the rear panel.

A 2 meter multi-core shielded cable is connected to the mini-Dsub 15-pin connector. Since the opposite side is cut off, process that side according to the connection destination.

For the connector's pin assignment and cable differentiation, see p. 18.

- Rack mount adapters

These adapters are for mounting the equipment on a 19-inch IEC, EIA standard rack, or JIS standard rack.

Each type of adapter is available as a 1-unit and 2-unit model (for side-by-side mounting), for a total lineup of 4 models.

2.2 Installation

a) Installation sites

Do not place the equipment with the rear panel facing down, because this may damage the connectors and hinder ventilation.

Place the equipment on a flat surface such as a desk so that the four rubber feet and stands on the bottom side rest on that surface.

b) Installation location conditions

- This product uses a fan for forced-air cooling and features air intake and exhaust vents on the side and rear panels for this purpose. To allow for ample air flow, be sure to maintain a gap of at least 10 cm between the sides and rear of this product and walls or other obstructions.
- Install this product at an altitude of 2000 m or less.
- Install this product in a location that meets the following conditions for temperature and humidity ranges.

Operating conditions: 0 to 40°C, 5 to 85%RH

Storage conditions: -10 to 50°C, 5 to 95%RH

Further, a condensation-free environment must be ensured. For limitations related to absolute humidity, refer to the specifications in this manual.

- Do not install the WF1973/WF1974 in the following locations:
 - Location with flammable gas
An explosion may occur. Never install and use this product in such a location.
 - Outdoors, or location exposed to direct sunlight or near a fire or heat source
The full performance of this product may not be obtained, or failure may occur.
 - Location with corrosive gas, moisture, dust, or high humidity
This product may become corroded or fail.
 - Location near an electromagnetic field source, high-voltage device, or power line
This product may malfunction.
 - Location exposed to excessive vibration
This product may malfunction or fail.

c) Panel and case cleaning

Use a soft cloth to wipe dust from the panel and case. If soiling is severe, moisten the cloth with a neutral detergent and wring it out well.

Do not use volatile substances such as thinners and benzene, or commercial wipes, as these may deform or peel the finish.

d) Rack mounting method

When provided with a rack mount adapter (option), this equipment can be mounted on a 19-inch IEC, EIA standard rack, or JIS standard rack. Either one unit, or two side-by-side units, can be mounted.

First, attach the rack mount adapter to the main unit, and then mount the main unit into the rack. For the rack mount adapter handling method, refer to the manual included with the adapter.

When rack mounting the main unit, observe the following cautions.

- Be sure to install rails in the rack to support the equipment.
- Mounting the equipment into a fully enclosed rack may cause it to fail due to rising temperature.

Be sure to provide sufficient ventilation openings and forcibly cool the inside of the rack with fans.

For external dimensions for rack mounting, refer to:

Inch rack mounting dimensions (for 1 unit) ☞ p. 149

Inch rack mounting dimensions (for 2 units) ☞ p. 150

Millimeter rack mounting dimensions (for 1 unit) ☞ p. 151

Millimeter rack mounting dimensions (for 2 units) ☞ p. 152

2.3 Grounding and Power Supply Connection

a) Grounding

Be sure to ground the equipment.



WARNING

This product uses a line filter. Be sure to ground this product. Otherwise, an electric shock may occur.

To prevent electric shock, be sure to safely implement grounding such that ground resistance is 100 Ω or lower.

When a 3-prong power plug that includes a protective ground contact is connected to a 3-prong power supply outlet, this product is grounded automatically.

This product does not come with a 3-prong to 2-prong conversion adapter. When using a separately sold 3-prong to 2-prong conversion adapter, be sure to connect the grounding wire of the adapter to the grounding terminal next to the outlet.

b) Power supply conditions

Voltage range: 100 V AC to 230 V AC $\pm 10\%$ (250 V or lower)

Frequency range: 50 Hz/60 Hz

Power consumption: WF1973: 50 VA or lower; WF1974: 75 VA or lower

c) Power supply connection procedure

- 1) Check that the commercial power supply voltage to be connected is within the voltage range specified for the equipment.
 - 2) Connect the power cord to the power supply inlet on the rear panel of the equipment.
 - 3) Connect the power cord plug to the 3-prong power supply outlet.
- The withstand voltage of the main unit proper is 1500 Vrms (AC).

⚠ CAUTION The power cord supplied with this equipment is designed to be used for this equipment only. Do not use this power cord for other equipment or purposes.

2.4 Calibration

This equipment should undergo performance testing about once a year as a guideline, although this depends on the usage environment and usage frequency. Moreover, when using this equipment to perform important measurements and tests, the execution of a performance test immediately before is recommended.

Performance testing of this equipment should be performed by a person with general knowledge of test instruments and experienced in their operation.

For details on performance tests, refer to “10. MAINTENANCE” in the Application Instruction Manual.

3. PANELS AND I/O TERMINALS

3.1 Panel Components and Operations

This section describes the names and functions of the various components on the front and rear panels.

3.1.1 Front panel of WF1973

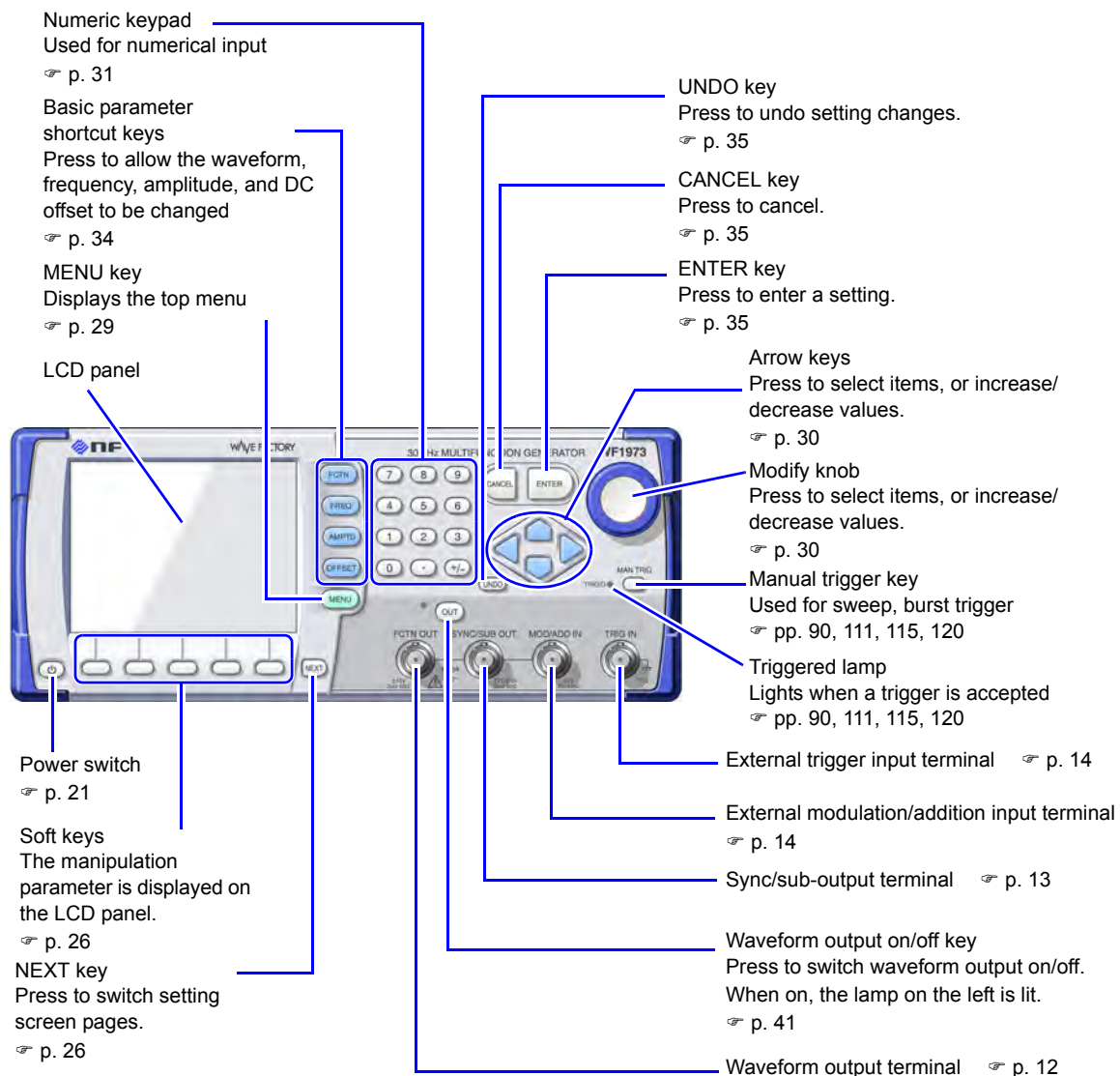

Figure 3-1. Front Panel of WF1973

3.1.2 Rear panel of WF1973

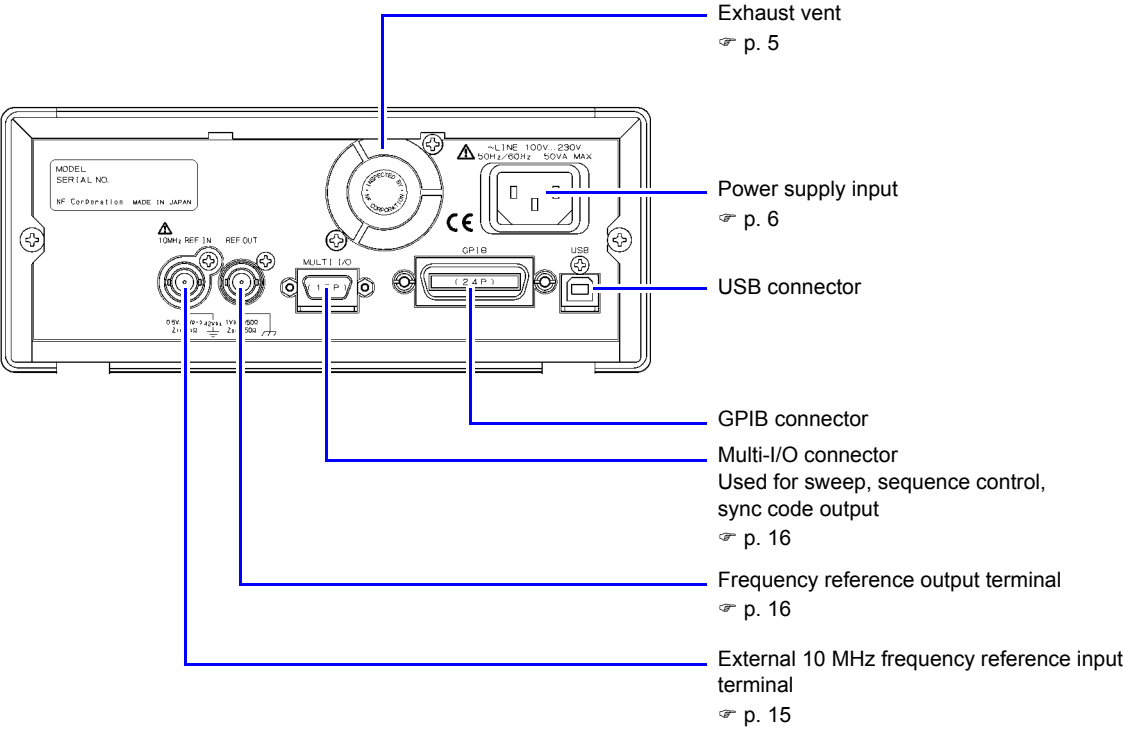

Figure 3-2. Rear Panel of WF1973

3.1.3 Front panel of WF1974

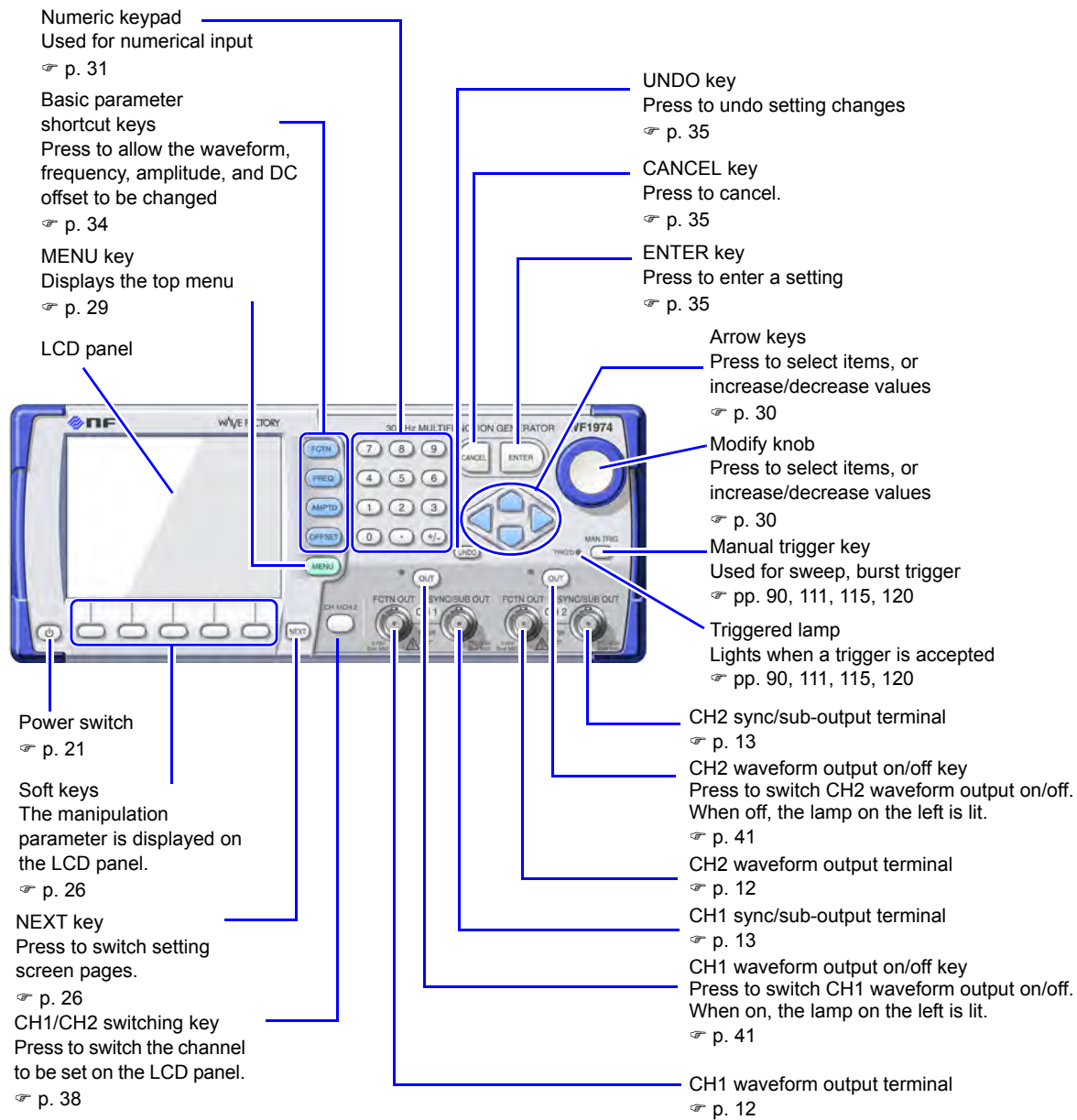

Figure 3-3. Front Panel of WF1974

3.1.4 Rear panel of WF1974

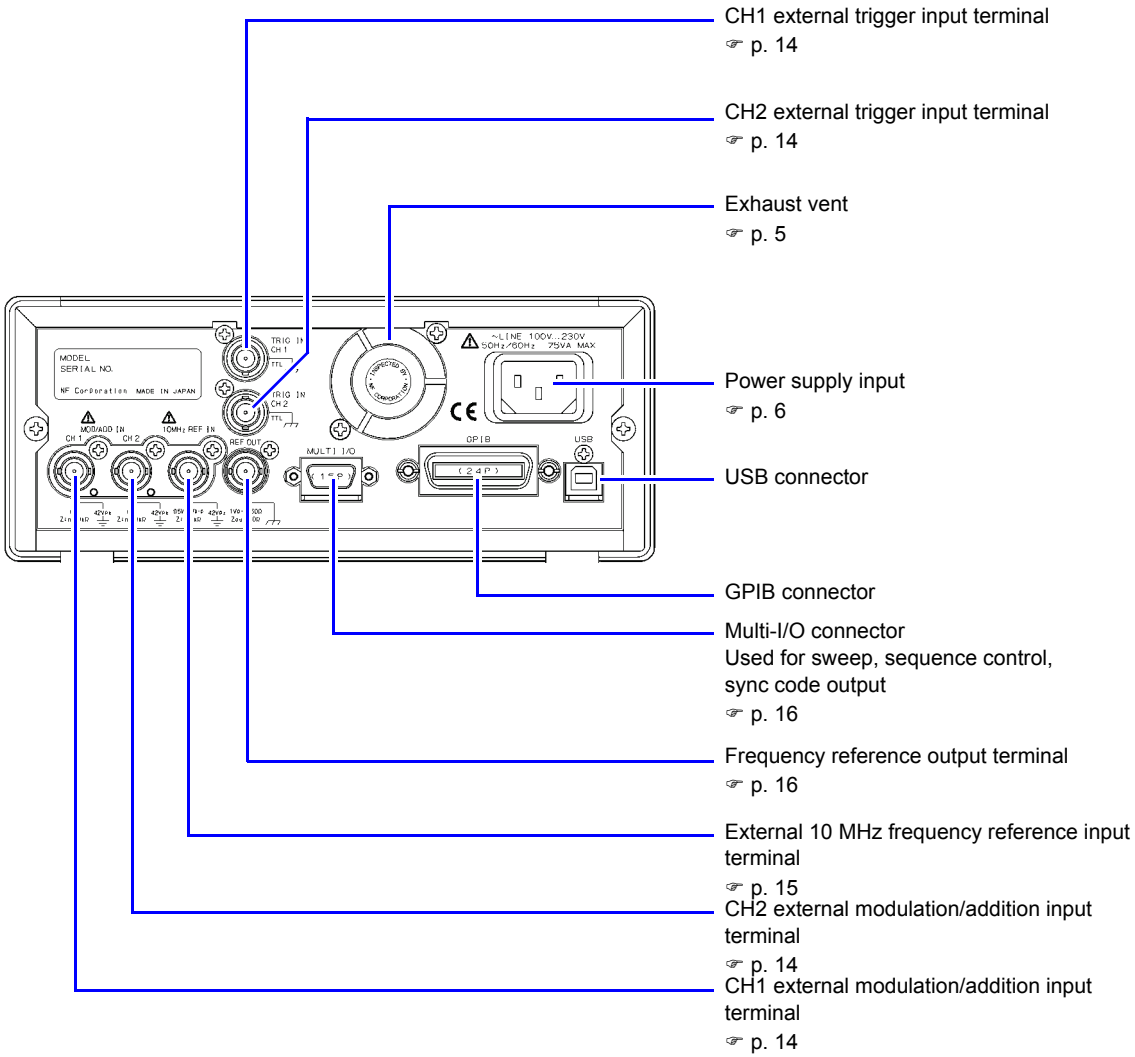

Figure 3-4. Rear Panel of WF1974

3.2 I/O Terminals

⚠ WARNING To prevent electric shocks, do not apply a voltage exceeding 42 Vpk (DC+AC peak) between the ground of the BNC connectors insulated from the housing and the housing.
 Also, do not apply a voltage exceeding 42 Vpk (DC+AC peak) between the grounds of the BNC connector groups insulated from the housing. “BNC connector group”, as used here, refers to multiple BNC connectors that are connected to a common ground.
 If such a voltage were to be applied, the internal voltage limiting elements will try to curb the working voltage, but if the voltage is too large, equipment burnout may result.
 ☞ p. 19

⚠ CAUTION Do not apply a voltage from external to the output terminal, as this may damage the equipment.

⚠ CAUTION Do not apply a voltage exceeding the maximum input level to the input terminal, as this may damage the equipment.

⚠ CAUTION If there is a difference in potential between the ground of a BNC connector insulated from the housing and the housing, do not short circuit the hot side of that BNC connector and the housing, as this may damage the equipment.

⚠ CAUTION If a difference in potential exists between the grounds of the BNC connectors, do not short circuit these BNC connector grounds, as this may damage the equipment.

3.2.1 Waveform output (FCTN OUT)



This is the main output.

■ **Output characteristics**

Output voltage	Maximum ± 10 V/open
Output impedance	50 Ω
Load impedance	0 Ω or higher (short-circuit protection provided)
Signal GND	Insulation from the housing (42 Vpk max.) WF1974: Insulation also between channels (42 Vpk max.)

3.2.2 Sync/sub-output (SYNC/SUB OUT)

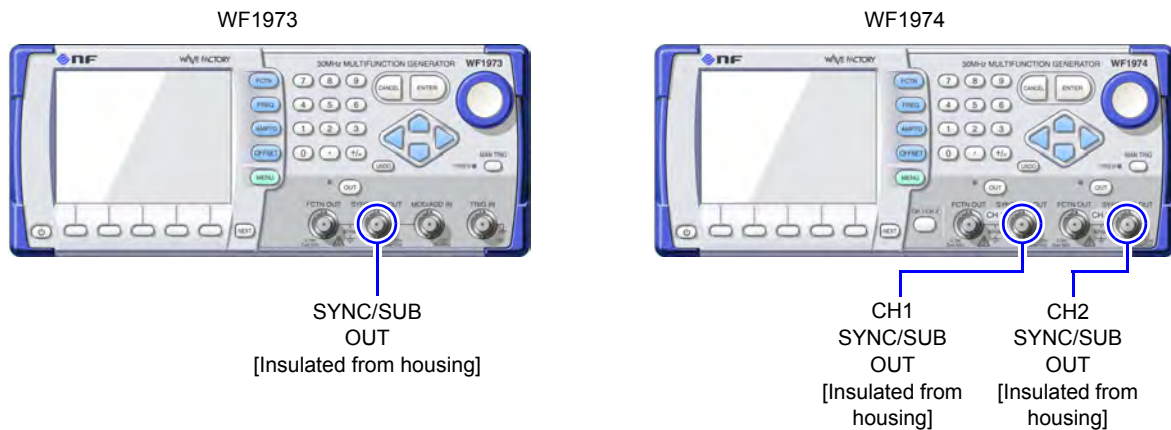

A sync signal is output according to the waveform or oscillation status. This signal can be used as the oscilloscope synchronization signal.

As shown in the following table, the output signal can be selected according to the oscillation mode.

Table 3-1. Signals Selectable for Sync/Sub-Output

Oscillation Mode	Selectable Output Signal
All	50% duty TTL level logic signal that rises at zero phase position of reference phase of waveform output (hereafter, reference phase sync signal). The phase relationship with waveform output can be changed. ☞ p. 45
Modulation mode with internal modulation source ☞ p. 74	<ul style="list-style-type: none"> Reference phase sync signal Internal modulation signal (-3 V to +3 V/open) TTL level logic signal synchronized with internal modulation signal
Sweep oscillation mode ☞ p. 92	<ul style="list-style-type: none"> Reference phase sync signal Sweep X drive signal (0 V to +3 V/open) TTL level logic signal synchronized with sweep, marker signal mixing possible
Burst oscillation mode ☞ pp. 108, 111, 115, 120	<ul style="list-style-type: none"> Reference phase sync signal TTL level logic signal synchronized with burst oscillation
Sequence oscillation mode ☞ “6.2 Basics” in the Application Instruction Manual	<ul style="list-style-type: none"> Reference phase sync signal TTL level logic signal synchronized with sequence step

■ Output characteristics

Output voltage	TTL level (low: 0.4 V or lower; high: 2.7 V or higher), -3 V to +3 V/open, 0 V to +3 V/open
Output impedance	50 Ω
Load impedance	50 Ω or higher recommended
Signal GND	Same potential as same channel waveform output, insulated from housing (42 Vpk max.). WF1974: Insulation also between channels (42 Vpk max.)

3.2.3 External modulation/addition input (MOD/ADD IN)

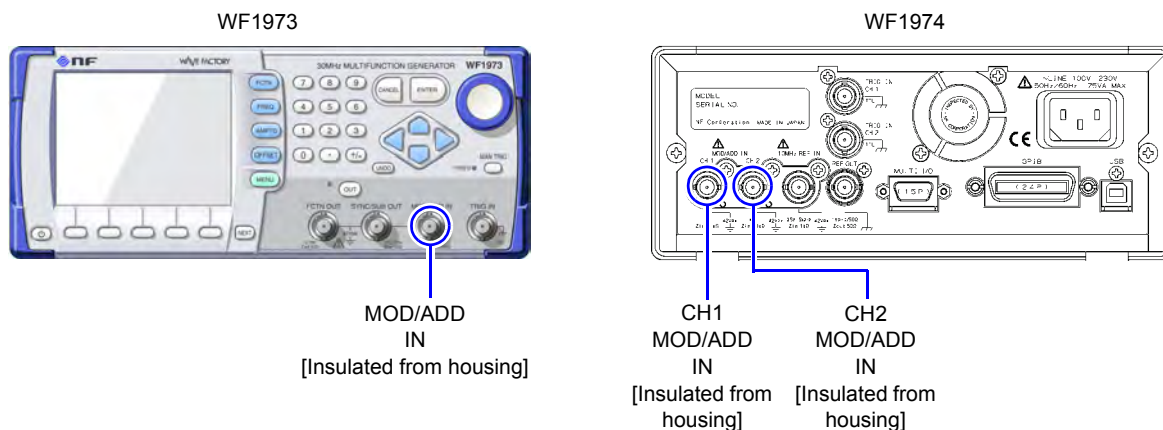

When the modulation source is external, except for FSK and PSK, an external modulation signal is input. In the case of the FSK and PSK, the external trigger input is used as external modulation signal input.

When not used as external modulation signal input, MOD/ADD IN may be used as the external addition signal input. The gain during external addition is either $\times 2$ or $\times 10$.

External modulation input: [p. 73](#).

External addition input: [p. 57](#).

■ Input Specifications

Input voltage	± 1 V full scale
Maximum allowed input	± 2 V
Input impedance	10 k Ω
Input frequency	During modulation: DC to 25 kHz During addition: DC to 10 MHz (-3 dB)
Signal GND	Same potential as same channel waveform output, insulated from housing (42 Vpk max.). WF1974: Insulation also between channels (42 Vpk max.)

3.2.4 External trigger input (TRIG IN)

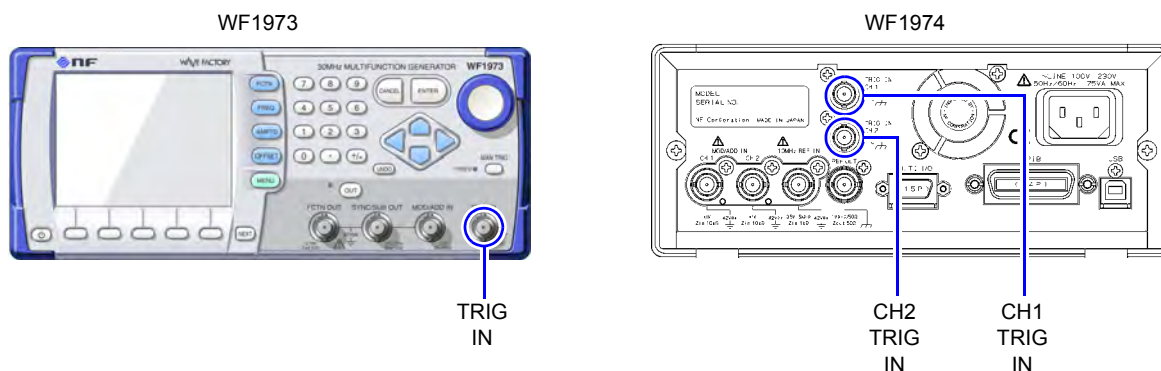

TRIG IN may be used as external trigger input in the following cases. The polarity setting can be changed.

- Single-shot sweep start trigger [p. 90](#).
- Gated single-shot sweep start trigger [p. 90](#).
- Trigger burst oscillation start trigger [p. 111](#).

- Gate of gated oscillation ☞ p. 115.
- Triggered gate oscillation trigger ☞ p. 120.
- Sequence oscillation start trigger ☞ “6.2 Basics” in the Application Instruction Manual
TRIG IN can also be used as the external modulation input for FSK and PSK ☞ p. 73

■ Input Characteristics

Input voltage	TTL level (low: 0.8 V or lower; high: 2.6 V or higher)
Maximum allowed input	-0.5 V to +5.5 V
Input impedance	10 k Ω , pull up to +3.3 V
Signal GND	Same potential as housing

3.2.5 External 10 MHz frequency reference input (10 MHz REF IN)

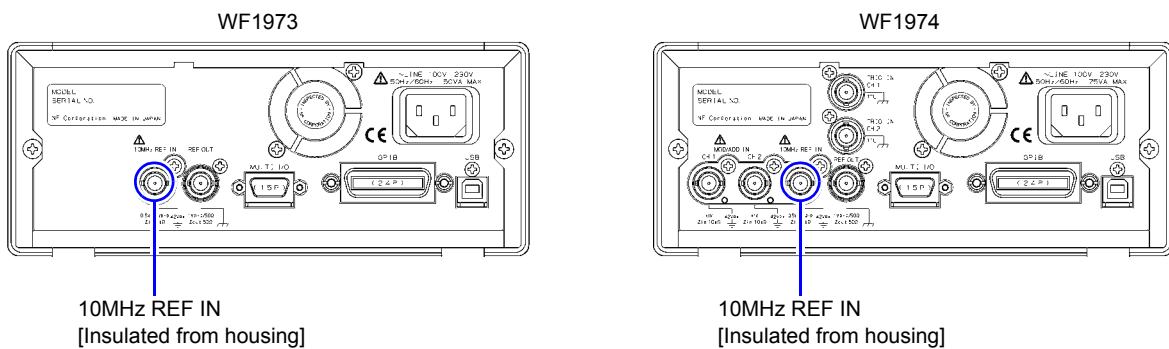

10 MHz REF IN can be used for the following purposes.

- **When frequency accuracy higher than the frequency accuracy specification of the equipment is required, or when the frequency reference of a different signal generator is desired**

Input the 10 MHz reference signal output from an external frequency standard or another signal generator.

Enable external frequency reference setting.

☞ “5. USING EXTERNAL FREQUENCY REFERENCE” in the Application Instruction Manual

- **To unify the frequency and phase for multiple WF1973, WF1974 units**

Connect the frequency reference output of the master unit when multiple units are combined in synchronous connection, or the master WF1973 or WF1974, to the external 10 MHz frequency reference input of the WF1973 or WF1974.

Set the frequency setting of each unit to the same value.

Also enable external frequency reference setting for the slave units and perform phase synchronization with the master unit.

☞ “4. SYNCHRONIZING MULTIPLE UNITS” in the Application Instruction Manual

The frequency accuracies of the connected WF1973 and WF1974 units are all the same as that of the master unit.

An external frequency standard can also be used for the master unit.

■ Input Characteristics

Input voltage	0.5 V _{p-p} to 5 V _{p-p}
Maximum allowed input	10 V _{p-p}
Input impedance	1 k Ω , AC coupled

3. PANELS AND I/O TERMINALS

Input frequency	10 MHz ($\pm 0.5\%$ (± 50 kHz))
Input waveform	Sine or square (50 $\pm 5\%$ duty)
Signal GND	Insulated from housing and each channel waveform output (42 Vpk max.)

3.2.6 Frequency reference output (REF OUT)

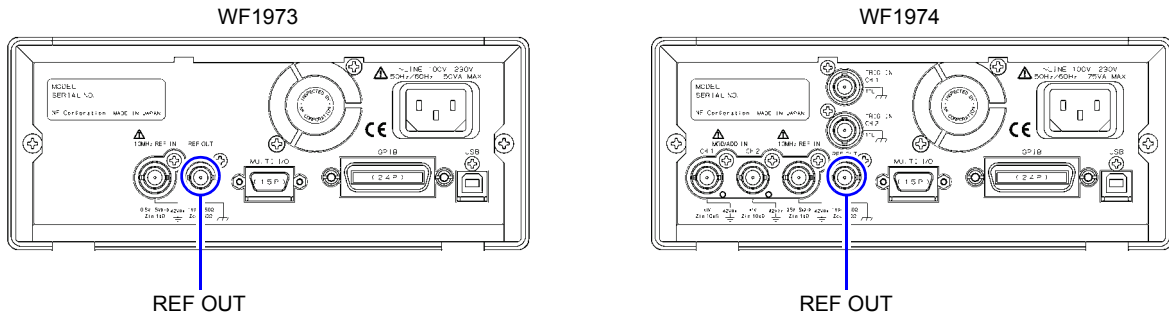

Use REF OUT to unify the frequency and phase for multiple WF1973, WF1974 units. Connect the frequency reference output of the master unit when multiple units are combined in synchronous connection, or the master WF1973 or WF1974, to the external 10 MHz frequency reference input of the WF1973 or WF1974.

☞ “4. SYNCHRONIZING MULTIPLE UNITS” in the Application Instruction Manual

■ Output Characteristics

Output voltage	1 Vp-p / 50 Ω
Output impedance	50 Ω , AC coupled
Output frequency	10 MHz
Output waveform	Square
Signal GND	Same potential as housing

✓ Check

Do not connect any equipment other than the WF1973 and WF1974 not specified by NF Corporation to the frequency reference output. The special signal that is output from this terminal during synchronization may make the operation of such connected equipment unstable.

3.2.7 Multi-I/O (MULTI I/O)

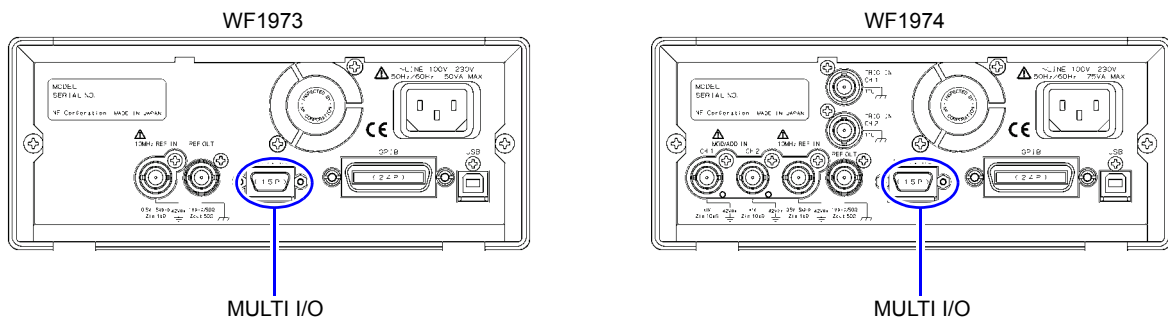

MULTI I/O can be used for sweep control and sequence control. It outputs the step synchronization code for the sequence.

■ Control input for sweep oscillation mode

The following types of control for sweep oscillation can be done with 3-bit logic input.

☞ p. 94

Start	Start the sweep from the start through fall input. ORed with external trigger input.
Stop	Stop the sweep through fall input.
Hold/resume	Hold the sweep through fall input during sweep execution. The sweep is resumed from where it was held through rise input during hold.

■ Control input for sequence oscillation mode

The following types of control for sequence oscillation can be done with 4-bit logic input.

☞ “6.2 Basics” in the Application Instruction Manual

Start or state branch	Start control and state branch control can be selected. During start control, the sequence is started from the beginning through fall input. ORed with external trigger input. During state branch control, the sequence is branched to the specified destination step through low level input upon step completion.
Stop	Stop the sequence through fall input.
Hold/resume	Hold the sequence through fall input during sequence execution. The sequence is resumed from where it was held through rise input during hold.
Event branch	The sequence is branched to the specified destination step through fall input.

In the sequence oscillation mode, the 4-bit step synchronization code specified for each step is output.

✓ Check

When not using control input for multi-I/O connector, it is recommended to disable control input to prevent malfunction due to external noise.

☞ p. 94

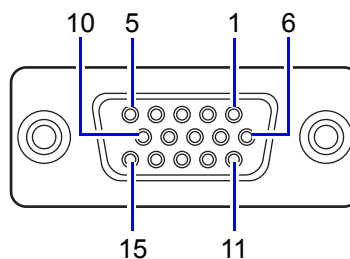

Figure 3-5. Multi-I/O Connector Pin Assignment

Table 3-2. Multi-I/O Connector Function Allocation

Pin No.	I/O	Sweep Oscillation Mode	Sequence Oscillation Mode	Option Cable Color and Marking
1	Output	Not used	Step sync code D0 (LSB)	Light brown Black ■
2	Output	Not used	Step sync code D1	Light brown Red ■
3	Output	Not used	Step sync code D2	Yellow Black ■
4	Output	Not used	Step sync code D3 (MSB)	Yellow Red ■
5	Output	Not used	Not used	Bright green Black ■
6	GND	–	–	Bright green Red ■
7	GND	–	–	Gray Black ■
8	GND	–	–	Gray Red ■
9	Reserved	Leave unconnected	Leave unconnected	White Black ■
10	GND	–	–	White Red ■
11	Input	Not used	Sequence event branch	Light brown Black ■■
12	Input	Sweep hold/resume	Sequence hold/resume	Light brown Red ■■
13	Input	Sweep stop	Sequence stop	Yellow Black ■■
14	Input	Sweep start	Sequence start or state branch	Yellow Red ■■
15	Input	Not used	Not used	Bright green Black ■■
Shell	–	–	–	Bright green Red ■■

Note: +5 V is output for testing purposes during production to pin No. 9. This pin is not designed for use by users. Leave this pin unconnected, as its use may cause the operation of the equipment to become unstable.

■ **I/O characteristics**

Input voltage	TTL level (low: 0.8 V or lower; high: 2.6 V or higher)
Maximum allowed input	–0.5 V to +5.5 V
Input impedance	10 kΩ, pull up to +5 V
Output voltage	TTL level (low: 0.4 V or lower; high: 2.7 V or higher)
Signal GND	Same potential as housing
Connector	Mini D-sub 15-pin

The connection cable is an option. Contact NF Corporation or an NF distributor for details.

3.3 Cautions on Floating Ground Connection

The signal ground of the BNC terminals for waveform output, sync/sub-output, and external modulation/addition input, is shared, but since it is insulated from the housing (ground potential), it can be connected to equipment that have a different potential. Moreover, the potential has no influence even when the equipment is mounted in a rack.

In the WF1974, the above-mentioned BNC terminals are also insulated between channels. Further, the signal ground of the external 10 MHz frequency reference input is also insulated from the housing. Therefore, noise caused by ground-loop is not a problem for connection with a frequency standard. Nor is noise caused by ground-loop a problem in the case of synchronized connection of multiple units of the WF1973 or WF1974.

However, in all cases, the floating voltage should be limited to 42 V_{pk} (DC+AC peak) or lower to prevent electric shocks.

The other signal grounds are all connected to the housing. The housing itself is connected to a protective grounding terminal.

⚠ WARNING To prevent electric shocks, do not apply a voltage exceeding 42 V_{pk} (DC+AC peak) between the ground of the BNC connectors insulated from the housing and the housing.

Also, do not apply a voltage exceeding 42 V_{pk} (DC+AC peak) between the grounds of the BNC connector groups insulated from the housing. "BNC connector group," as used here, refers to multiple BNC connectors that are connected to a common ground.

If such a voltage were to be applied, the internal voltage limiting elements will try to curb the working voltage, but if the voltage is too large, equipment burnout may result.

⚠ CAUTION If there is a difference in potential between the ground of a BNC connector insulated from the housing and the housing, do not short circuit the hot side of that BNC connector and the housing, as this may damage the equipment.

⚠ CAUTION If a difference in potential exists between the grounds of the BNC connectors, do not short circuit these BNC connector grounds, as this may damage the equipment.

■ Cautions on Floating Ground Connection for WF1973

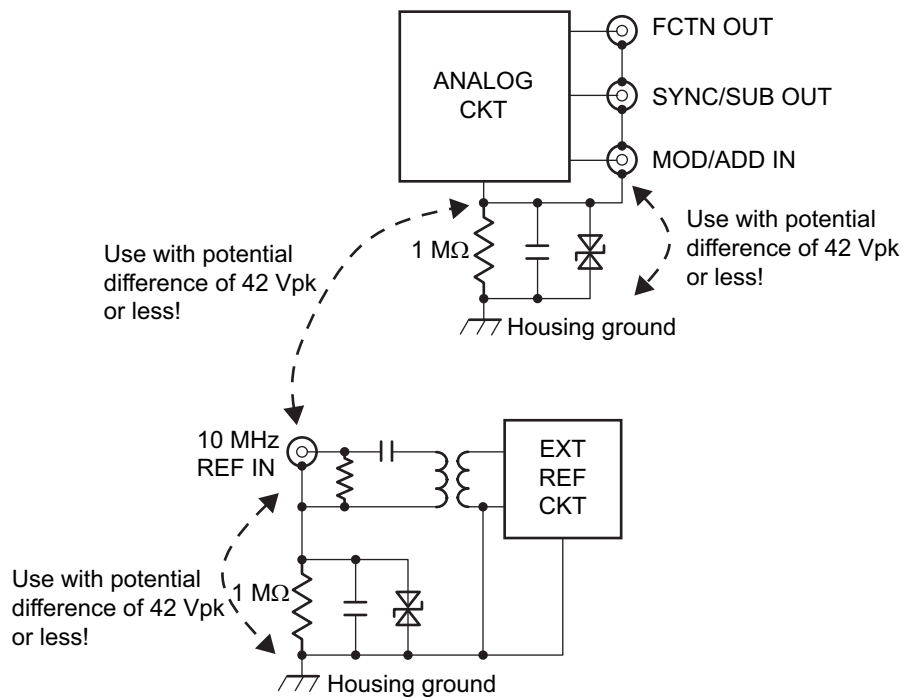

Figure 3-6. Cautions on Floating Ground Connection for WF1973

■ Cautions on Floating Ground Connection for WF1974

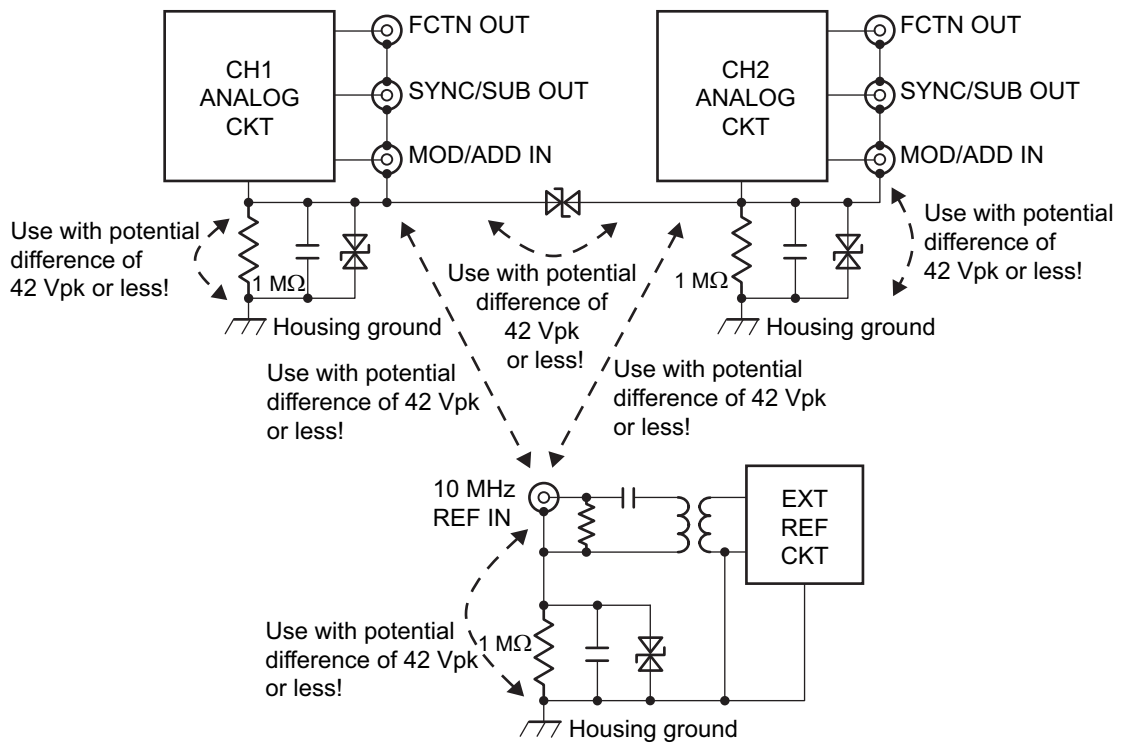

Figure 3-7. Cautions on Floating Ground Connection for WF1974

4. BASIC OPERATION

4.1 Power on/off Switching and Restoration of Settings

4.1.1 Power on/off switching method

■ Power-on procedure

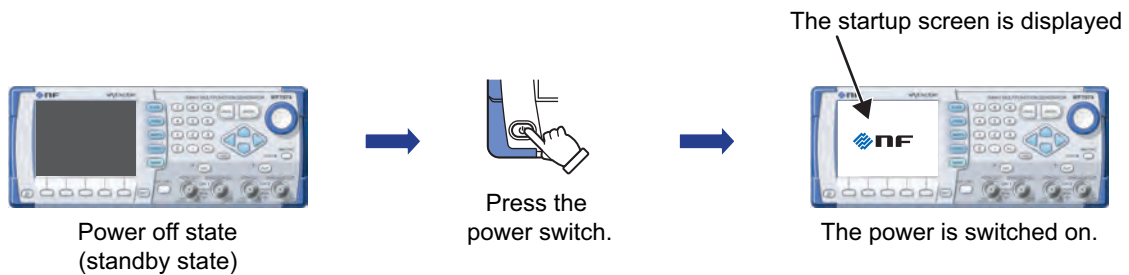

Once the power is switched on, a self-check test is automatically executed and the unit becomes operable.

■ Power-off procedure

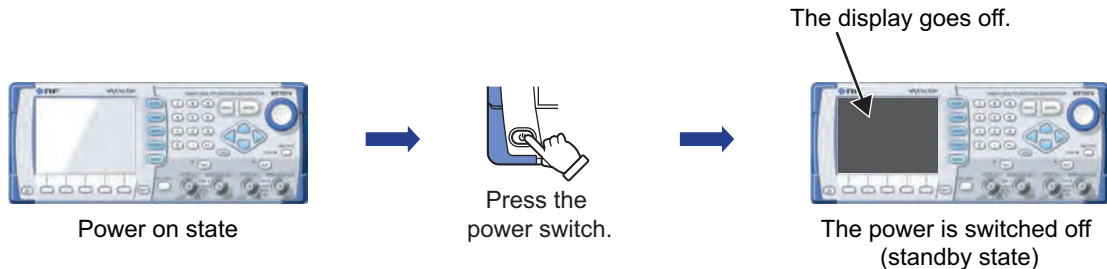

4.1.2 Restoration of settings at power-on

When the power is switched on/off with the power switch, the settings before the previous time the power was switched off are restored when the power is switched on again.

The output on/off settings at power-on can be set on the Utility screen. (p. 41)

However, if the power supply to the equipment is directly cut off while the equipment's power is on, the settings are set to the contents of setting memory 1 when the equipment is powered on again.

a) Restoration of settings when power switch is switched on/off while power supply is connected

The most general case is illustrated below.

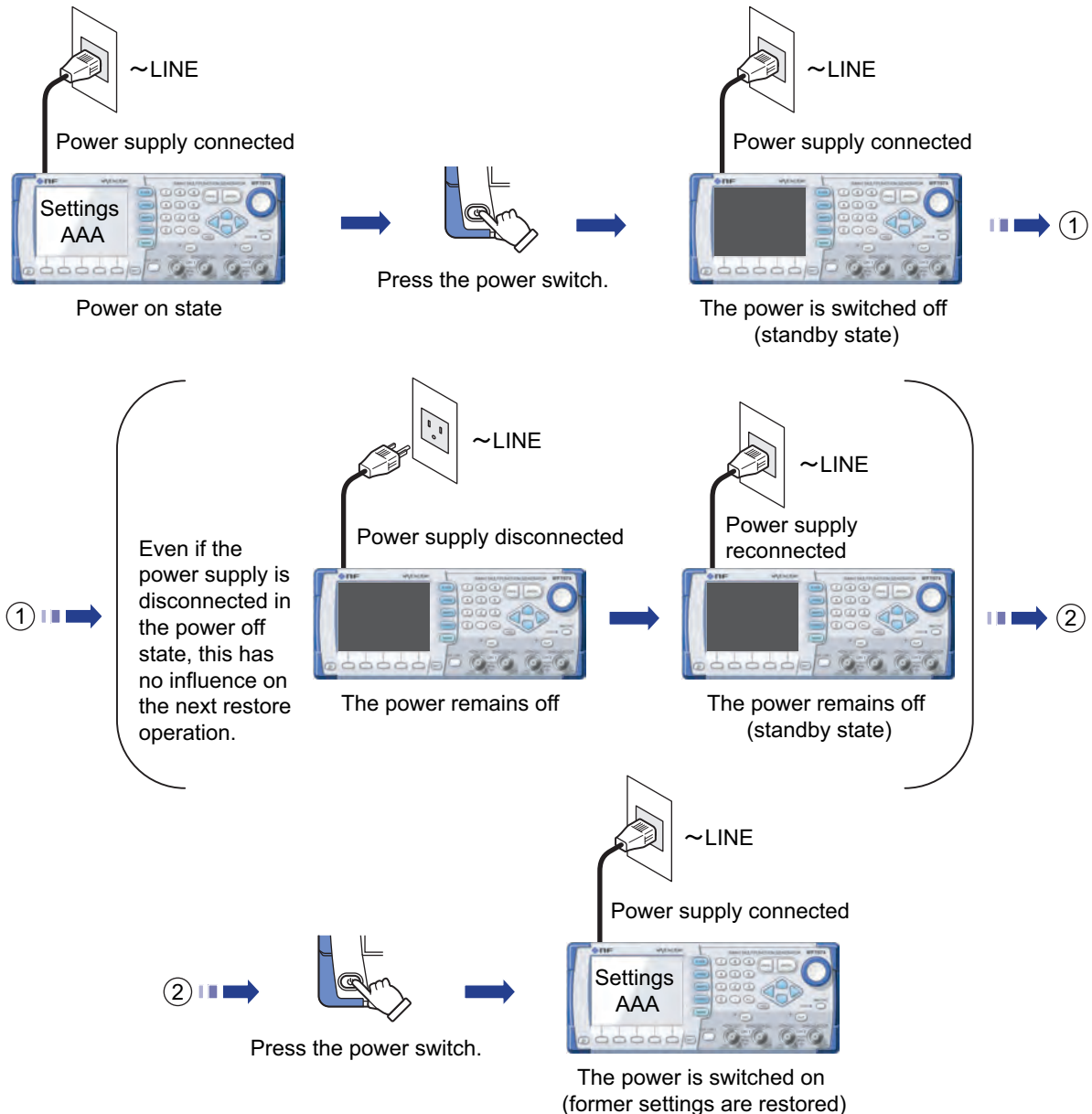

While the equipment power is off, even if the power supply is cut off due to the disconnection of the cord or the shutoff of a connected breaker, this has no influence on the restore operation the next time the equipment is powered on again.

- The settings before the equipment was powered off last are restored.
- The output on/off settings at power-on can be set on the Utility screen.  p. 41

 **Check**

The previous settings can be restored only if the equipment was powered off using the power switch.

b) Restoration of settings during power supply on/off

This applies to switching the power supply on/off at one time for this equipment and other embedded devices when this equipment is mounted in a rack.

When the power supply is cut off while the equipment power is on, the equipment power automatically goes on the next time the power supply is reconnected.

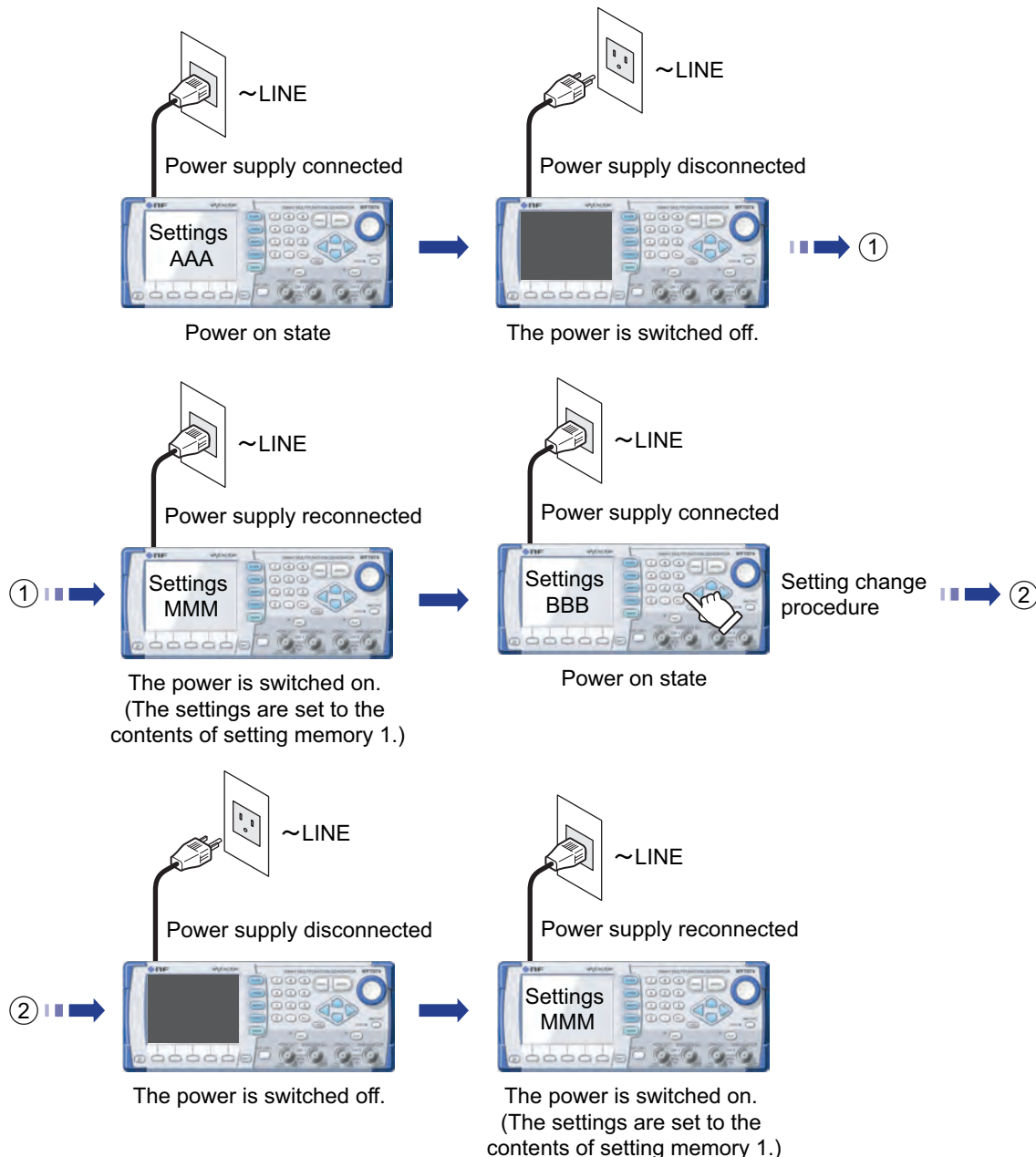

- The settings before the power is switched off cannot be restored.
- The contents of setting memory number 1 are set. ☞ p. 122
- The output on/off settings at power-on can be set on the Utility screen. ☞ p. 41

✓ Check

Since the settings before the power supply is cut off are not restored, specify the contents of setting memory number 1 beforehand if required. ☞ p. 122

4.2 Screen Configuration and Operation

4.2.1 Screen configuration

The screen consists of three areas, as shown in the following figure.

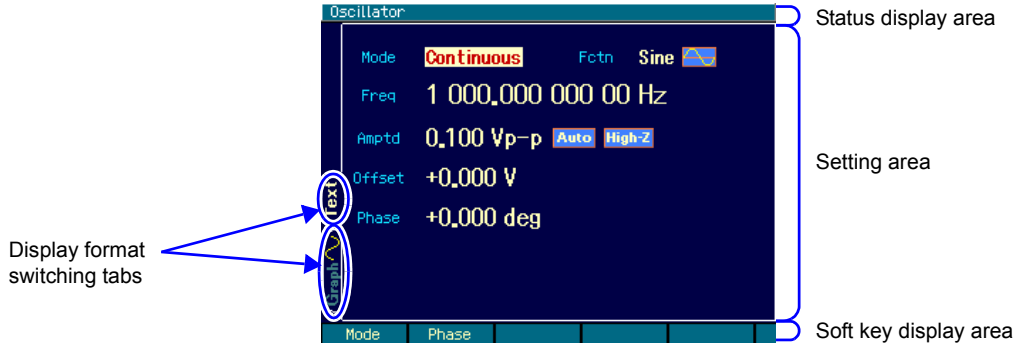

■ Status display area

Displays the status of the equipment.

The following items are displayed.

- Uncalibrated status **UCal**
Displayed when the calibration information of the equipment is lost due to a problem, and the prescribed performance cannot be maintained. Since this is a malfunction, notify NF Corporation or an NF distributor.
- Overheating status **Temp**
Displayed when the internal temperature of the equipment becomes abnormally high. When this status is displayed during use at an ambient temperature of 40°C or lower, this indicates a malfunction, so notify NF Corporation or an NF distributor.
- Remote status **USB**, **GPIB**
Displayed when the equipment is controlled via the USB or GPIB interface.
- External frequency reference status **Ref**
Displays whether a valid signal is input or not, when the external frequency reference is enabled.
- Sequence status/channel mode (WF1974 only)
The status when the sequence oscillation mode is selected is displayed.
In the WF1974, the mode when the channel mode is other than independent (2-phase, constant frequency difference, constant frequency ratio, and differential output).
- 2-channel same value (Both) setting (WF1974 only) **Both**
Displayed when the same setting is done for CH1 and CH2.

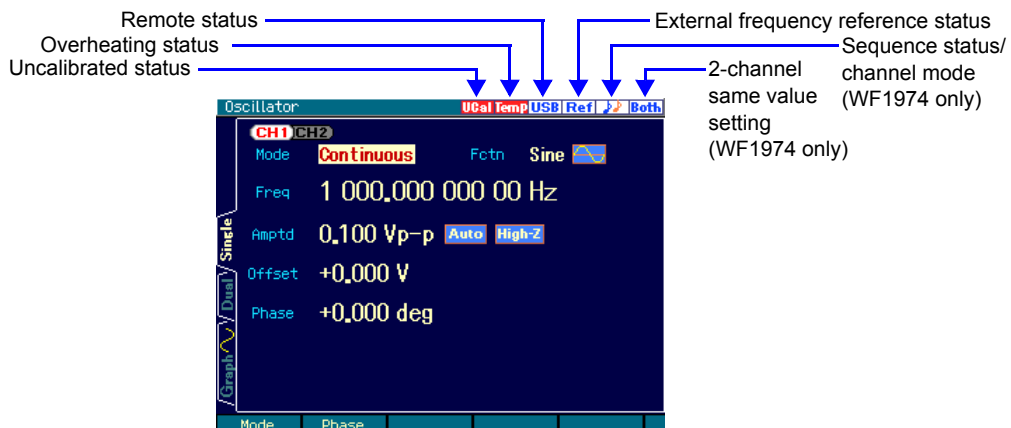

■ **Setting area**

This area is used to display and set the various parameters.

When multiple display formats can be selected, display format switch tabs are displayed on the left side of the screen. ☞ p. 27

Due to the large number of setting parameters in the case of modulation, sweep, and burst oscillation, the setting screen consists of two or three pages. The screen pages can be switched with the NEXT key.

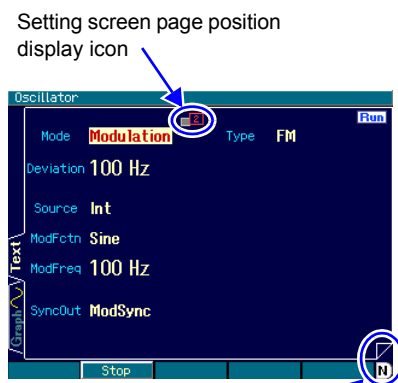
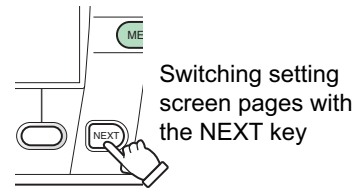

When there are several setting screen pages, an icon indicating which page is displayed appears at the top center of the screen.

In the example on the left, there is a total of two setting screen pages, and the icon indicates that the second page is currently displayed.

■ **Soft key display area**

Displays the functions of the soft keys allocated according to the status.

If five or more soft keys are allocated, “▼ n/m” is displayed over the right-most soft key. This indicates that the set of soft keys belonging to the current setting screen extends of m stages, and that the set corresponding to the nth stage is currently displayed. When the soft key over which “▼ n/m” is displayed is pressed, the next set of soft keys is displayed.

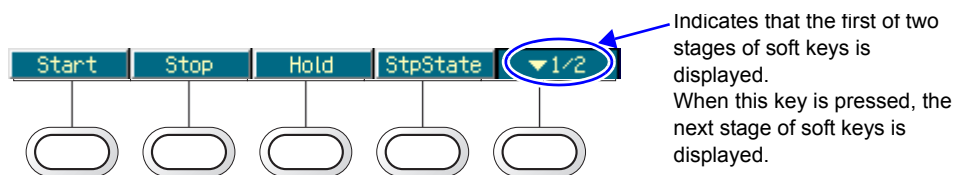

4.2.2 Switching display format with tabs (displaying waveform graph)

When a number of display formats can be selected, a display format switching tab is displayed on the left side of the screen. When the Graph tab is displayed on the screen, settings can be performed while checking the image of the output waveform.

a) Display format types

There are three types of display formats, as follows.

■ Text display [Text] (WF1973) or [Single](WF1974)

Displays the settings of 1 channel in text form.



■ Graph display [Graph]

Displays the settings of one channel in both text and graph form, allowing the image of the output waveform to be checked.

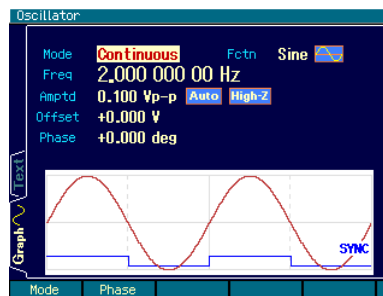

■ 2-channel simultaneous display [Dual] (WF1974 only)

Displays the settings of channel 1 and channel 2 in text form vertically superposed.

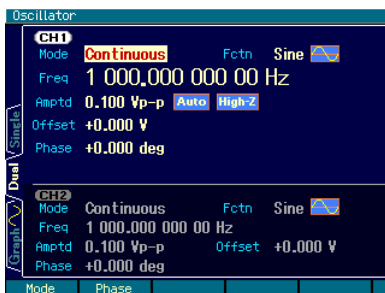

The channel to be set can be switched with the CH1/CH2 key.

b) Switching the display format

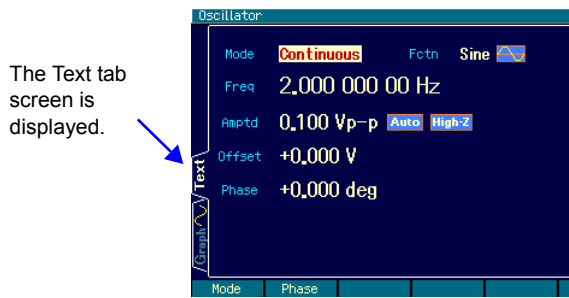

The Text tab screen is displayed.

1. In the example on the left, the Text tab screen is displayed. On this screen, the settings are displayed in text form.

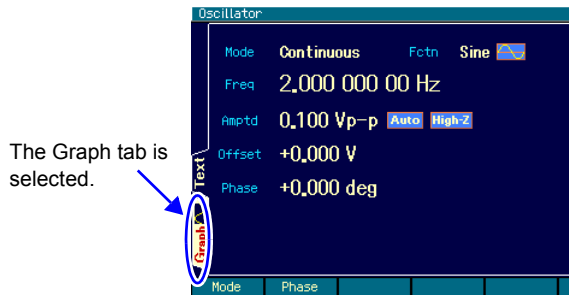

The Graph tab is selected.

2. Select the Graph tab with the arrow keys or the modify knob.

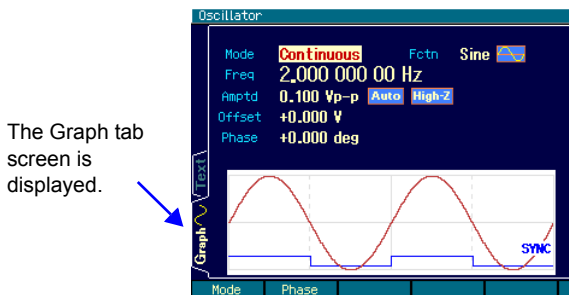
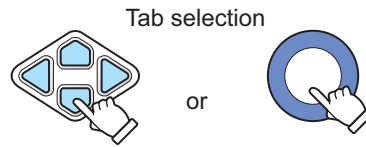

The Graph tab screen is displayed.

3. The Graph tab screen display is switched to by pressing the ENTER key. The settings can be done while checking the image of the output waveform on this screen.



✓ Check

In the WF1974, display can be switched between 1-channel display and 2-channel simultaneous display.

4.2.3 Top menu

Sequence oscillation, arbitrary waveform editing, system settings, saving and recalling settings, and other actions are done by selecting the desired item from the top menu.

a) Displaying the top menu

Press the **MENU** menu key to display the following top menu window.

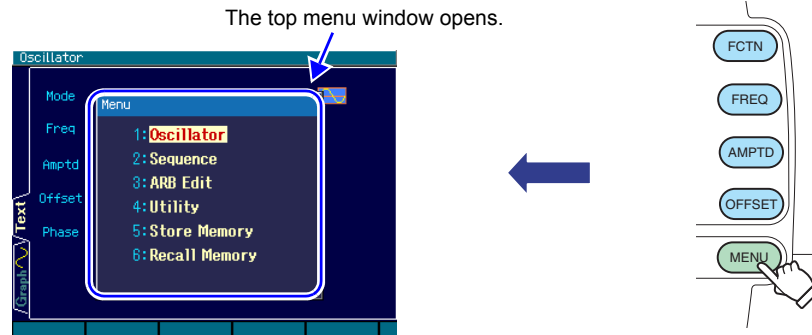

Select the desired menu item using the up/down arrow keys or the modify knob, and then press the **ENTER** ENTER key to display the menu item setting screen.

With the top menu window open, the desired menu item can also be specified by inputting a number using the **0**...**9** numeric keypad.

If the display contents are invisible for the backlight out, press on the **MENU** menu key for a while to light up the backlight forcibly.

b) Actions possible using the top menu items

The menu items are displayed at the top left of each setting screen.

Settings and operations such as those described below can be done with the various menu items.

■ Oscillator

Almost all settings other than arbitrary waveform editing and sequence oscillation can be set and manipulated. When the power is applied, the Oscillator setting screen is always displayed.

■ Sequence

Sequence oscillation setting and manipulation can be done. [☞ “6. USING SEQUENCE OSCILLATION”](#) in the Application Instruction Manual

■ ARB edit

Arbitrary waveform editing can be done. [☞ “2. CREATING ARBITRARY WAVEFORMS”](#) in the Application Instruction Manual

■ Utility

Various settings and manipulations can be done. [☞ p. 39](#)

■ Store memory

The settings can be saved to the setting memory. [☞ p. 122](#)

■ Recall memory

The settings can be called from the setting memory. [☞ p. 124](#)

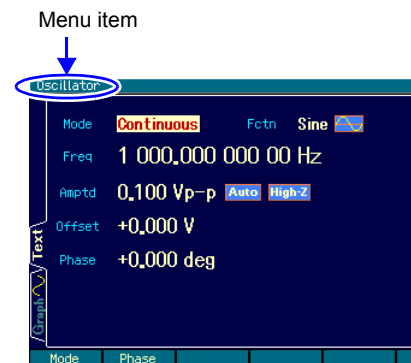

4.3 Basic Settings and Operations

4.3.1 Changing the frequency, amplitude, and other values

a) Changing a value with the up/down arrow keys or the modify knob



The frequency is selected. The current frequency is displayed.

1. Select the desired item with the arrow keys or the modify knob. In the example on the left, the [Freq] frequency field is selected.

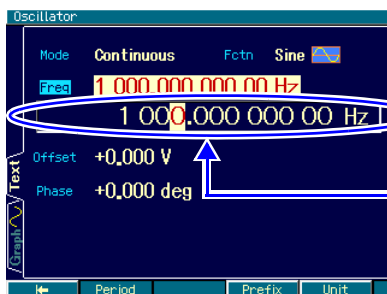
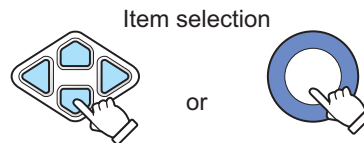

The input field is opened.

2. Press the ENTER key. The input field below the selected item opens and the selected item status changes so that the current value can be changed. In this state, a value can also be input by using the numeric keypad.

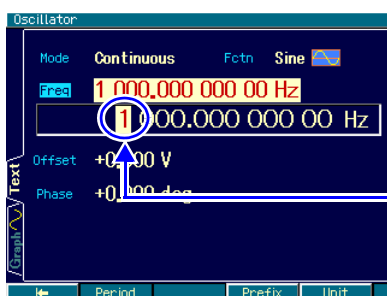

The digit to be changed is the 1 kHz digit.

3. Press the left/right arrow keys to move the cursor to the digit of the value to be changed. In the example on the left, the cursor is moved to the 1 kHz digit.

Cursor movement

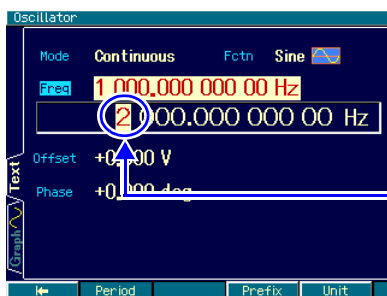

The value of the changed digit is now 2.

4. Increment or decrement the value of the digit to be changed with the up/down arrow keys or the modify knob. In the example on the left, the value is changed to 2 kHz. The change is instantly reflected to the output.

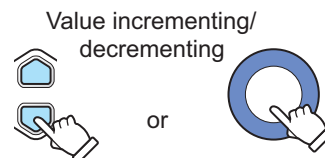

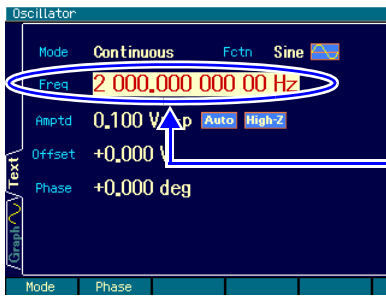

The input field has closed.

5. Press the ENTER key to close the input field.



If the CANCEL key is pressed instead of the ENTER key, the value changed with the modify knob is discarded and the status of step 1 (pre-change setting) is returned to.

b) Changing a value with the 0...9 numeric keypad



The frequency is selected. The current frequency is displayed.

1. Select the desired item with the arrow keys or the modify knob. In the example on the left, the [Freq] (frequency) field is selected.

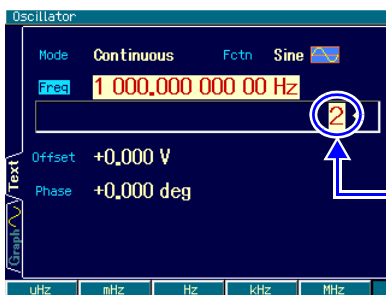
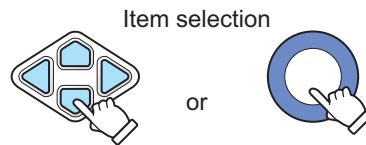

The input field opens and a value is input.

2. Press a key of the numeric keypad. The input field under the selected item opens and the numeric value is input. In the example on the left, "2" is input. During numeric input, the left arrow key serves as the delete key, and the right arrow key as the zero input key.

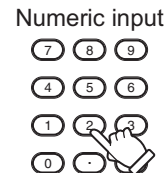

The setting is changed and the input field closes.

3. Press the ENTER key or the unit key (soft key) to set the input value and reflect it to the output. The input field closes. If the ENTER key is pressed, the setting is performed in a unit without the "k" or "m" prefix.

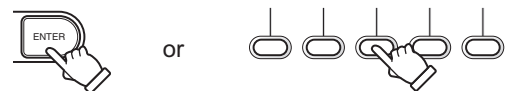

If the CANCEL key is pressed instead of the ENTER key, the input value is discarded and the setting remains unchanged.

✓ Check

During numeric input, the left arrow key serves as the delete key, and the right arrow key as the zero input key.

 **Check**

If a setting item is displayed on a soft key, the input field for that item can be opened by pressing that soft key.

4.3.2 Changing the waveform and oscillation mode

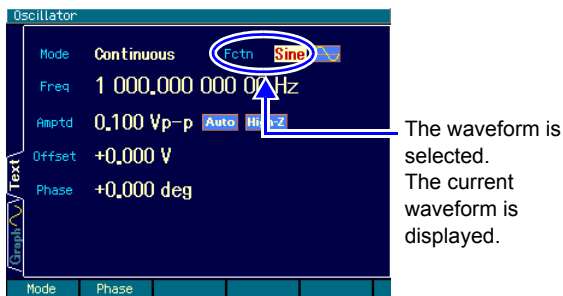

1. Select the desired item with the arrow keys or the modify knob. In the example on the left, the [Fctn] (waveform) field is selected.

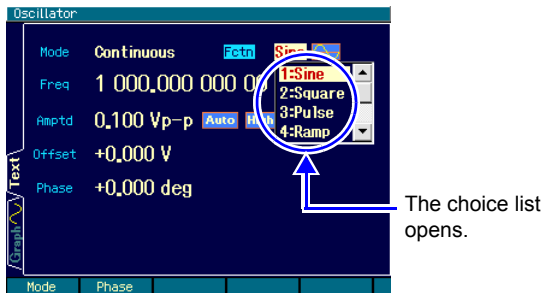
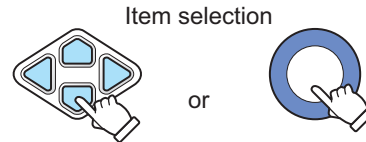

2. Press the ENTER key to open the list of choices.

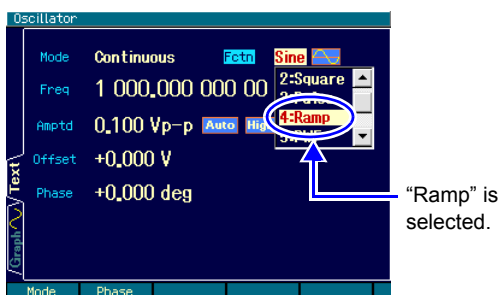

3. Scroll the choice list with the up/down arrow keys or the modify knob. In this state, the desired item can also be selected by inputting a number from the numeric keypad.

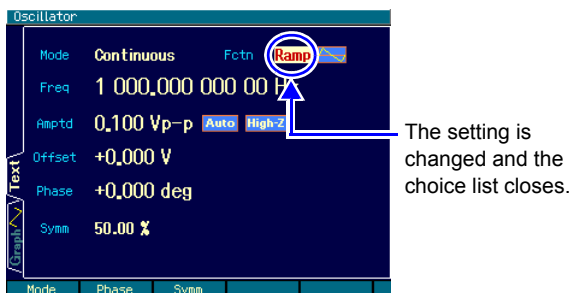
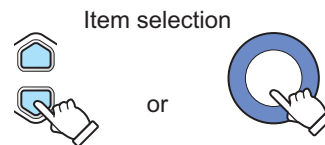

4. Press the ENTER key to set the selected item and reflect it to the output. The list of choices closes.



(If the CANCEL key is pressed instead of the ENTER key, the setting remains unchanged and the status of step 1 is returned to.)

4.3.3 Manipulating shortcut keys for changing basic parameters

The choice list or input field for waveform, frequency, amplitude, and DC offset can be immediately opened with the corresponding basic parameter shortcut key.

■ Waveform

p. 44

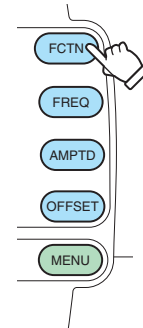
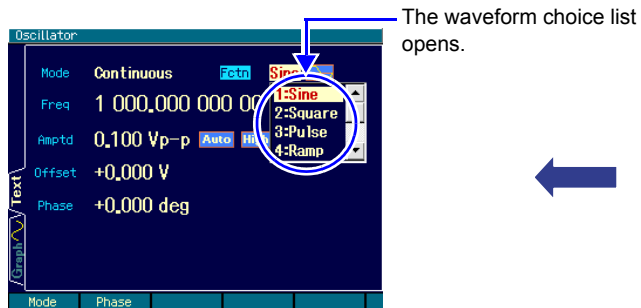

■ Frequency

p. 44

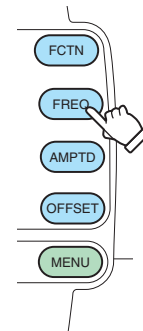
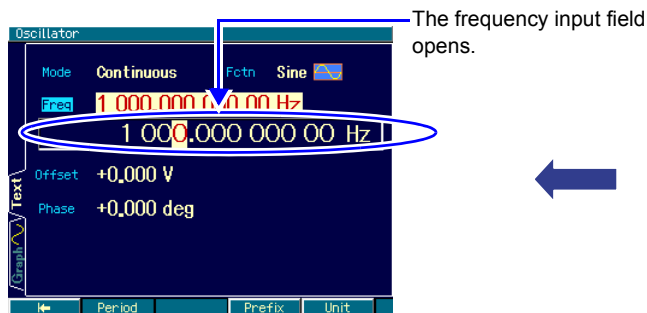

■ Amplitude

p. 48

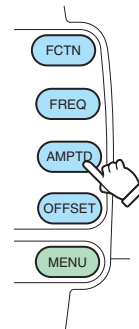
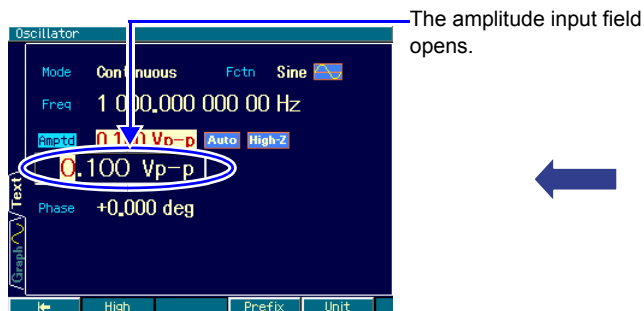

■ DC offset

p. 50

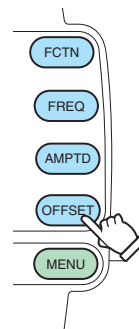
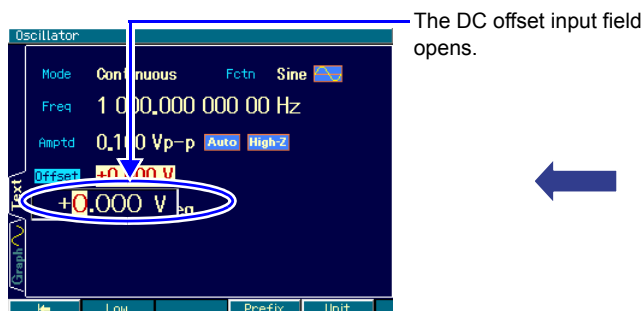

4.3.4 Operations of ENTER key, CANCEL key, and UNDO key

■ ENTER key operation

The ENTER key can be used to perform the following actions.

- Open the input field or choice list for the selected item
- Set the value input from the numeric keypad
- Perform the function of the button displayed on the screen

■ CANCEL key operation

The CANCEL key can be used to perform the following cancellation actions. However, once a setting has been changed, the original setting cannot be returned to (this can be done with the UNDO key described next).

- Close an input field or choice list
- Discard a value input from the numeric keypad
- Return a changed value to the original value with the modify knob
- Close the setting window or dialog box

■ UNDO key operation

The UNDO key can be used to restore the settings changed by using the ENTER key or the modify knob. Changes to settings that have been automatically executed as the result of the user's manipulations can also be restored to the original settings.

When the UNDO key is pressed again immediately following undo manipulation, the settings are restored to their state before undo.

It should be noted, however, that undo does not work for some items.

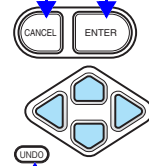

4.3.5 Changing the display unit

a) Changing the prefix (unit prefix: k, m, M, etc.)

Frequency is used as an example below. The amplitude and pulse width can be changed in a similar manner.

1. Select frequency and then press the ENTER key to open the input field.

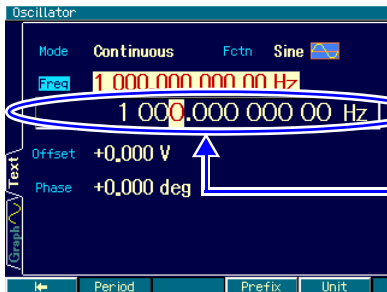

The input field opens.



2. Press the [Prefix] soft key and the cursor will move to before "Hz". The right arrow key can also be used to move the cursor to before "Hz".

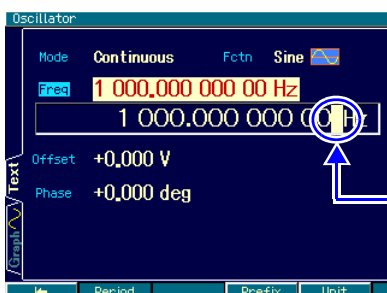

The cursor moves to before "Hz" when [Prefix] is pressed.



3. Change the unit to MHz, kHz, Hz, mHz, or uHz with the up/down arrow keys or the modify knob. Even when the display unit and decimal point position are changed, the value of the setting itself remains unchanged.

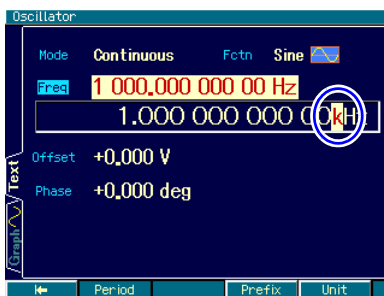
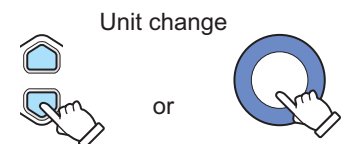

kHz display

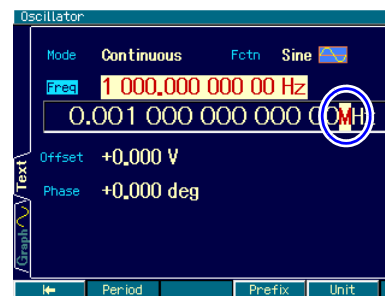

MHz display

b) Changing Vp-p, Vrms, user-defined unit, etc.

Amplitude is used as an example below. The frequency and pulse width can be changed in a similar manner.

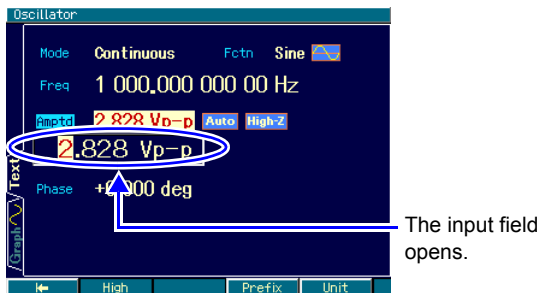

1. Select amplitude and then press the ENTER key to open the input field.

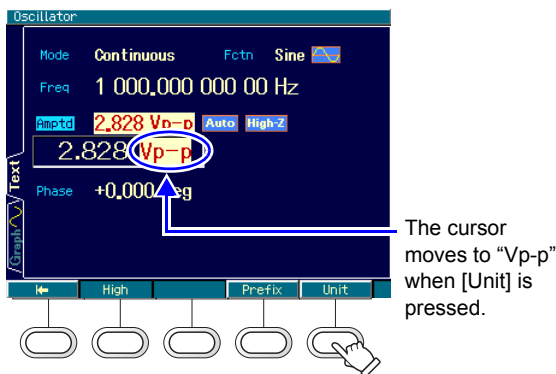

2. Press the [Unit] soft key and the cursor will move to "Vp-p". The right arrow key can also be used to move the cursor to "Vp-p".

3. The unit can be changed to Vrms, dBV, or a user-defined unit with the up/down arrow keys or the modify knob (in the case of sine wave, load impedance High-Z). Even when the display unit is changed, the output value remains unchanged.

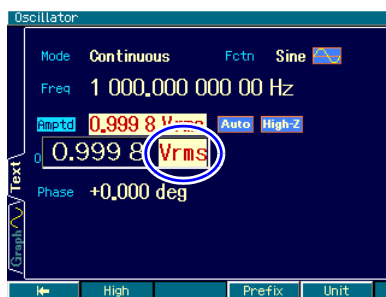
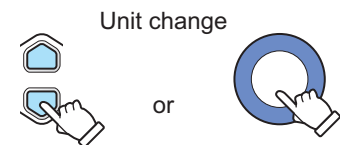

Vrms display



dBV display

Also refer to the following sections:

- Changing the frequency and period settings ☞ p. 45.
- Changing the amplitude unit (Vp-p, Vpk, Vrms, dBm, dBV) ☞ p. 48.
- Changing the pulse width time and duty settings ☞ p. 61.
- Setting the user-defined unit ☞ "7. USING USER-DEFINED UNITS" in the Application Instruction Manual

4.3.6 CH1/CH2 switching key and active channel (WF1974 only)

The channel to be set is switched each time the CH1/CH2 switching key is pressed.

This key is invalid in setting screens that are channel independent.

The channel that is to be set is called the “active channel” in this product. In the burst oscillation mode, etc., the  MAN TRIG key works for the active channel. Even if the screen is changed to a channel independent screen, the channel that was active up to that point is saved.

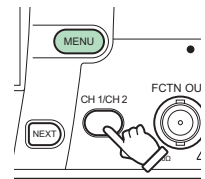

CH1/CH2 switching key

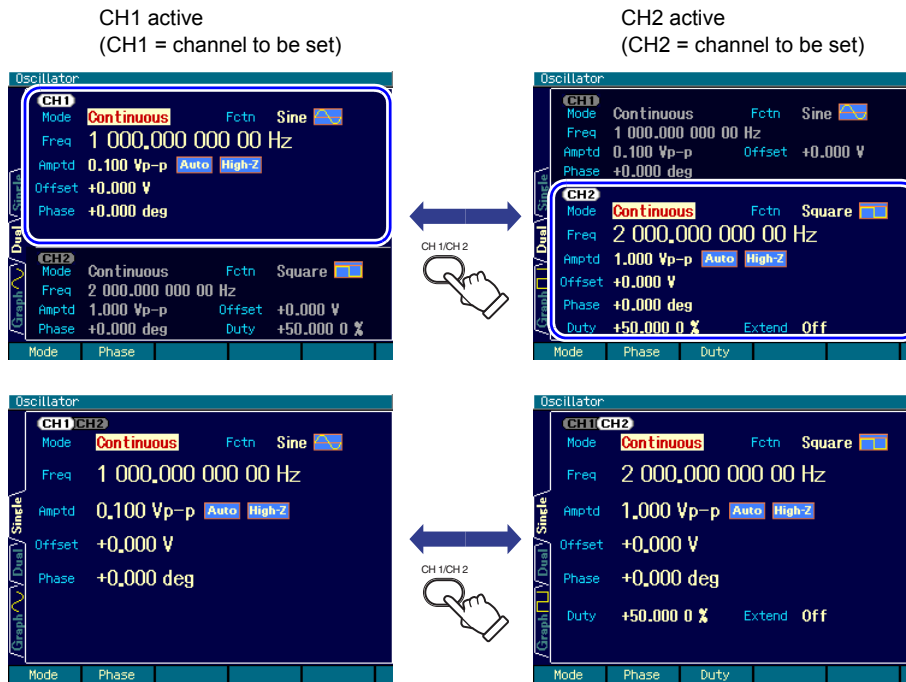

4.3.7 Actions possible in the Utility screen

a) Displaying the Utility screen

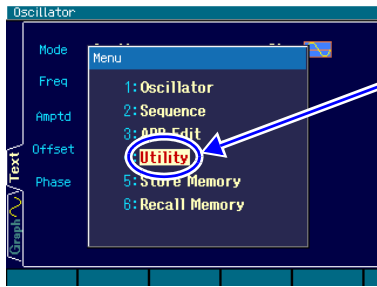

Select [Utility] in the top menu and press the ENTER key

The top menu window is displayed by pressing the **MENU** MENU key. In this window, select [Utility] and then press the **ENTER** ENTER key to display the Utility screen.

b) Utility screen configuration

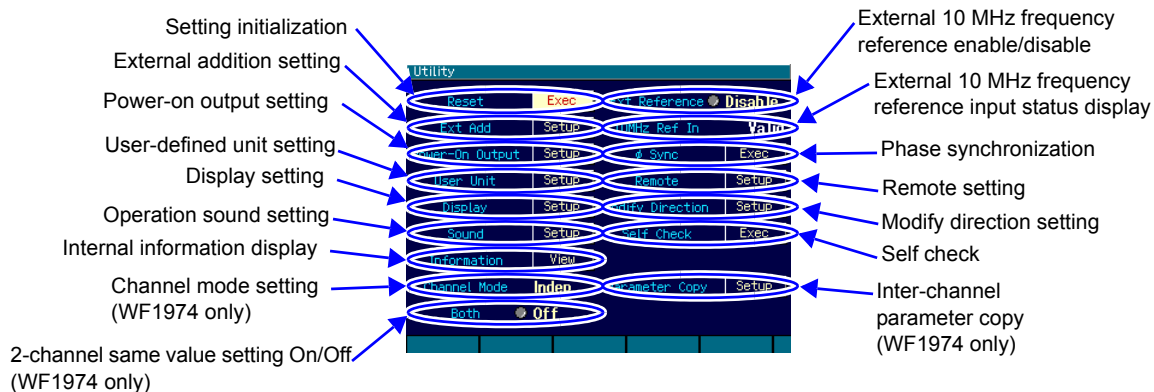

Setting initialization [Reset]

Initializes the settings. The initial settings are continuous oscillation, sine wave, 1 kHz, 0.1 Vp-p/open, and output off. ☞ p. 41

External 10 MHz frequency reference enable/disable [Ext Reference]

Enables/disables the external 10 MHz frequency reference. ☞ “5. USING EXTERNAL FREQUENCY REFERENCE” in the Application Instruction Manual

External addition setting [Ext Add]

Sets external addition gain. The setting can be selected from off, $\times 2$, and $\times 10$. ☞ p. 57

External 10 MHz frequency reference input status display [10MHz Ref In]

Displays whether a valid signal for external 10 MHz frequency reference input is available. ☞ “5. USING EXTERNAL FREQUENCY REFERENCE” in the Application Instruction Manual

Power-on output setting [Power-On Output]

Sets the output on/off setting at power-on. ☞ p. 41

Phase synchronization [ϕ Sync]

Performs inter-unit synchronization during multiple unit synchronization connection and inter-channel synchronization of the WF1974. ☞ “3.3 Phase Synchronization Between Channels” and “4. SYNCHRONIZING MULTIPLE UNITS” in the Application Instruction Manual.

User-defined unit setting [User Unit]

Sets user-defined units. ☞ “7. USING USER-DEFINED UNITS” in the Application Instruction Manual.

Remote setting [Remote]

Selects GPIB/USB and sets the GPIB address. The USB ID is also displayed. ☞ “8.1 Selecting Remote Interface [Remote]” in the Application Instruction Manual.

Display setting [Display]

Sets the backlight of the display. ☞ “8.2 Display Settings [Display]” in the Application Instruction Manual.

If the display contents are invisible for the backlight out, press on the  MENU key for a while to light up the backlight forcibly.

Modify direction setting [Modify Direction]

Sets the movement direction when the modify knob is turned. ☞ “8.3 Modify Knob and Modify Direction Setting [Modify Direction]” in the Application Instruction Manual.

Operation sound setting [Sound]

Sets the operation sound. ☞ “8.4 Operation Sound Setting [Sound]” in the Application Instruction Manual.

Self-check [Self Check]

Performs internal status check. ☞ “8.5 Self Check [Self Check]” in the Application Instruction Manual.

Internal information display [Information]

Displays the firmware version and latest calibration date. ☞ “8.6 Product Information Display [Information]” in the Application Instruction Manual.

Channel mode setting [Channel Mode] (WF1974 only)

Sets the type of 2-channel ganged operation. Independent, 2-phase, constant frequency difference, constant frequency ratio, and differential output can be selected from. ☞ “3.4 Maintaining Both Channels to Same Frequency (2-Channel Ganged Operation, 2-Phase)”, “3.5 Keeping Frequency Difference Constant (2-Channel Ganged Operation, 2-Tone)”, “3.6 Keeping Frequency Ratio Constant (2-Channel Ganged Operation, Ratio)”, and “3.7 Obtaining Differential Output (2-Channel Ganged Operation, Differential)” in the Application Instruction Manual.

Inter-channel parameter copy [Parameter Copy] (WF1974 only)

Copies the settings between channels. ☞ “3.1 Copying Settings Between Channels” in the Application Instruction Manual.

2-channel same value setting On/Off [Both] (WF1974 only)

Switches on/off setting of the same value for both channels. ☞ “3.2 Unifying Settings of 2 Channels” in the Application Instruction Manual.

4.3.8 Restoring the initial settings

The initial settings can be restored from the Utility screen.

The initial settings that are restored consist of continuous oscillation, sine wave, 1 kHz, 0.1 Vp-p/open, and output off.

For a list of the initial settings, see p. 126.

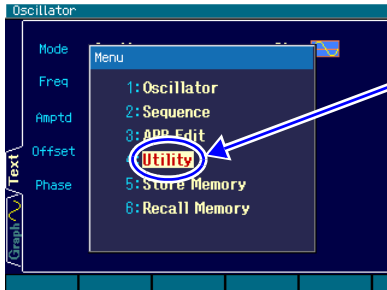

In the top menu, select [Utility] and then press the ENTER key.

1. Press the **MENU** MENU key to display the top menu window. In that window, select [Utility] and then press the **ENTER** ENTER key to display the Utility screen.

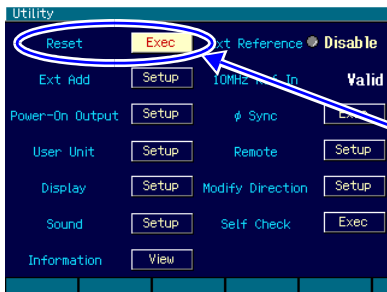

On the Utility screen, select [Reset] and then press the ENTER key.

2. On the Utility screen, select the [Reset] field and then press the **ENTER** ENTER key. The settings are initialized.

4.3.9 Output on/off

a) Manipulation method on panel

Each time the waveform output on/off key is pressed, the waveform output is switched on/off. When the output is on, the lamp located to the left of the key lights.

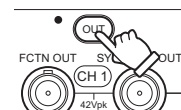
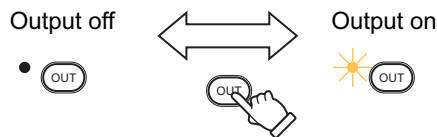

Output on/off key

When the output is off, the output terminal is open. When the output is on, the output impedance is 50 Ω. Sync/sub output is always on regardless of the on/off setting of the waveform output.

b) Setting at power-on

The waveform output on/off status at power-on can be specified.

The output setting at power-on can be selected from the following three.

- Off [Off]
The output is off.
- On [On]
The output is on.

- Return to previous setting [Last State]

The operation differs as follows according to the method used the previous time to set the power off.

If the power was switched off the previous time with the power switch on the panel

The settings before the power was switched off are restored.

If the power was switched off the previous time by cutting off the power supply

The output is off.

This is the case when the equipment is mounted along with other devices on a rack and the power supply to all the units is switched on/off at the same time.

The operation is done on the Utility screen.

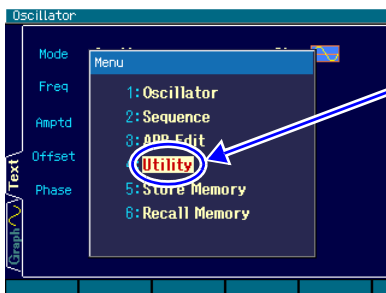

1. Press the **MENU** MENU key to display the top menu window. In this window, select [Utility] and then press the **ENTER** ENTER key to display the Utility screen.

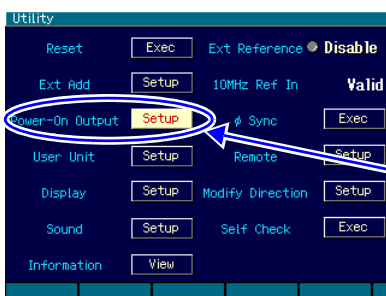

2. On the Utility screen, select the [Power-On Output] field and then press the **ENTER** ENTER key.

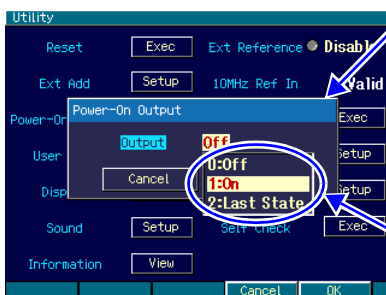

3. The power-on output setting window is displayed, so select the desired item and then press the **ENTER** ENTER key. The output setting condition choice list is displayed, so select the desired item and then press the **ENTER** ENTER key.

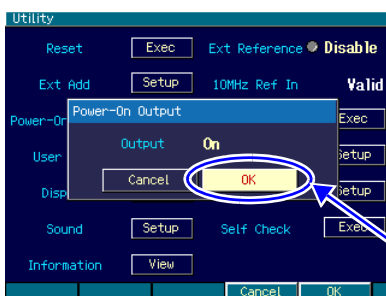

4. Once the desired power-on output setting has been completed, select [OK] in the lower part of the window and then press the **ENTER** ENTER key. The power-on output setting change is applied and the window closes.

To not apply the power-on output setting change, select [Cancel] in the lower part of the window and then press the **ENTER** ENTER key, or press the **CANCEL** CANCEL key.

4.4 Setting Methods for Main Items

This section describes the setting methods for the main items, mainly done on the Oscillator setting screen. “Oscillator” is displayed at the top left of the Oscillator setting screen. When another screen is displayed, pressing the **[MENU]** MENU key displays the top menu, so select [Oscillator] and then press the **[ENTER]** ENTER key.

The following explanation uses the text display screen (1 channel display) in the continuous oscillation mode. The setting screen consists of one page only.

4.4.1 Configuration of text display screen in continuous oscillation mode

This screen is where the basic settings for the output waveform are done.

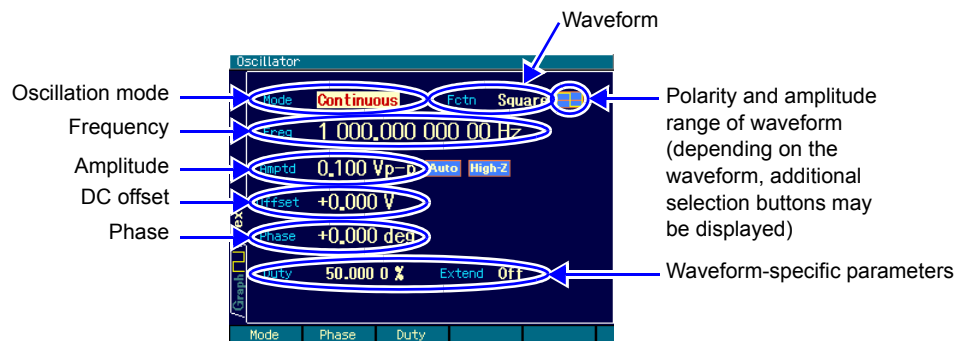

4.4.2 Setting the oscillation mode

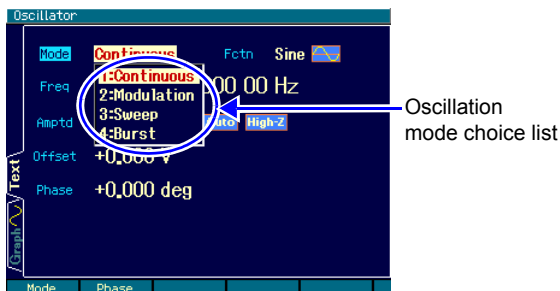

1. Select the [Mode] field and then press the **[ENTER]** ENTER key to display the oscillation mode choice list.

Even if there are several setting screens, the [Mode] field is displayed at the top left of each page.

2. Select the desired oscillation mode from the choice list and then press the **[ENTER]** ENTER key to apply the setting and reflect it to the output.

The desired oscillation mode can also be set and reflected to the output by inputting the number of the desired oscillation mode displayed in the choice list from the numeric keypad.

The oscillation mode can also be set by inputting a number from the numeric keypad while the [Mode] field is selected (without the choice list displayed).

4.4.3 Setting the waveform

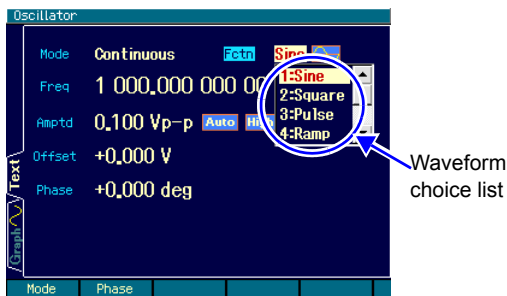

1. Press the **FCTN** FCTN shortcut key to display the waveform choice list. Alternatively, select the [Fctn] field and press the **ENTER** ENTER key to open the choice list. Even if there are several setting screens, the [Fctn] field is always displayed at the top right of the first page.

2. Select the desired waveform from the choice list and then press the **ENTER** ENTER key to apply the setting and reflect it to the output. The desired waveform can also be set and reflected to the output by inputting the number of the desired waveform displayed in the choice list from the numeric keypad. The desired waveform can also be set by inputting a number from the numeric keypad while the [Fctn] field is selected (without the choice list displayed).

4.4.4 Setting the frequency

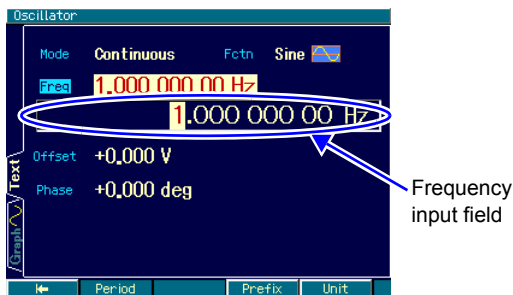

1. Press the **FREQ** FREQ shortcut key to display the frequency input field, or select the [Freq] field and then press the **ENTER** ENTER key to open the input field. Even if there are several setting screens, the [Freq] field is always displayed at the top left of the first page. When [Period] is displayed in the [Freq] field and the period and not the frequency is displayed, either press the **FREQ** FREQ key or press the [Freq] soft key, to switch to the frequency display.

2. Select the digit to be changed with the **◀▶** left/right arrow keys, and increment/decrement the value with the **⬆️⬇️** up/down arrow keys or the **⦿** modify knob. The change is instantly reflected to the output. Alternatively, enter a numeric value using the **0...9** numeric keypad. Then press the **ENTER** ENTER key or one of the unit keys (soft keys: [uHz] [mHz] [Hz] [kHz] [MHz]) to set the input value and reflect it to the output. If the ENTER key is used, the unit is set to Hz.

4.4.5 Performing setting with period

Settings can be performed using the period instead of the frequency.

The frequency display can be changed to the period display with one of the following two methods.

○ Changing to period display with [Freq] / [Period] soft key

When the frequency input field is open and the current frequency is displayed, the [Period] soft key is displayed. Press this key to open the period input field and change the item display from [Freq] to [Period].

The [Period] soft key changes to [Freq]. When the [Freq] key is pressed, the frequency input field opens again.

○ Changing to period display by pressing the **FREQ** key twice

While the frequency input field is not open, press the **FREQ** shortcut key twice to open the period input field.

When either the frequency or period input field is open, the frequency display and period display are toggled each time the **FREQ** key is pressed.

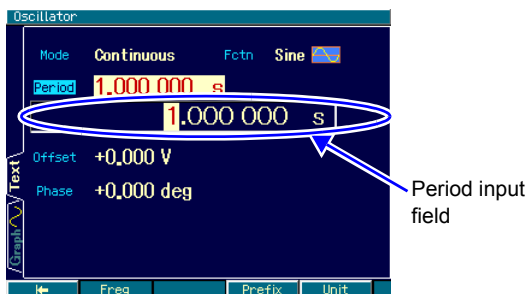

Once the period input field is opened, the setting procedure is the same as for the frequency.

When a value is input with the numeric keypad, the unit key for period setting is displayed as a soft key.

When period display is changed to, the display changes as follows.

Item name: Freq → Period

Unit display: Hz → s

Soft key: Period → Freq

4.4.6 Setting the phase

a) Setting method

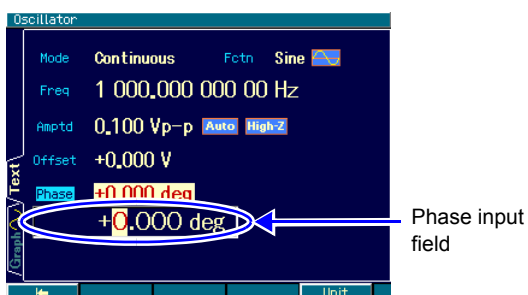

1. Select the [Phase] field and then press the **ENTER** key to open the phase input field.

Even if there are several setting screens, the [Phase] field is always displayed on the first page.

2. Select the digit to be changed with the **◀▶** left/right arrow keys, and increment/decrement the value with the **⬆️⬇️** up/down arrow keys or the **⦿** modify knob. The change is instantly reflected to the output.

Alternatively, enter a numeric value using the **0...9** numeric keypad. Then press the **ENTER** key or the [deg] unit key (soft key) to set the input value and reflect it to the output. If the **ENTER** key is used, the unit is also set to deg.

b) Items that can be changed in the phase setting

The following items can be changed with the phase setting.

■ **The phase difference between the sync/sub-output's reference phase sync output and waveform output can be changed**

The following example assumes a phase setting of $+90^\circ$. At this time, the waveform output's zero phase position is 90° ahead of the rise of the reference phase sync output.

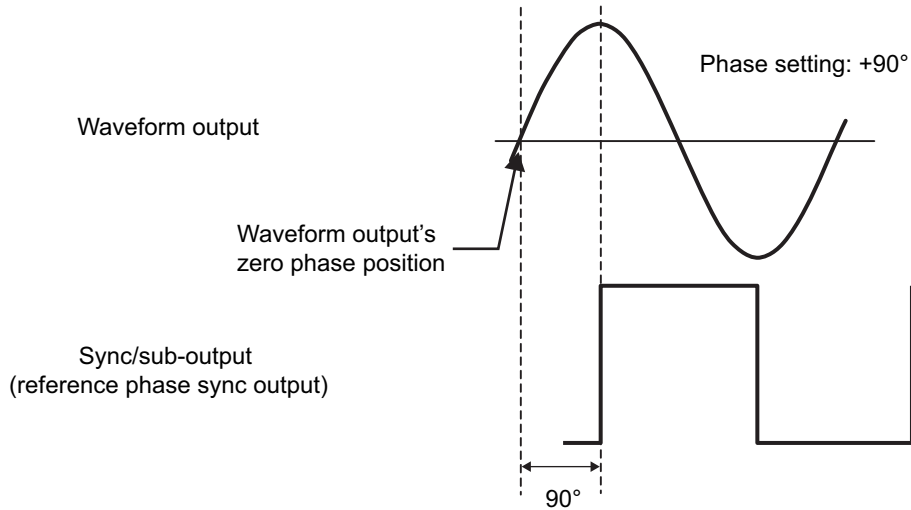

■ **The oscillation start/stop phase for burst oscillation, gated single-shot sweep can be changed**

The following example is burst oscillation with the oscillation start/stop phase set to $+30^\circ$. At this time, the oscillation starts at $+30^\circ$ and stops at the same $+30^\circ$ position.

Burst oscillation: [☞ p. 105](#), gated single-shot sweep: [☞ p. 89](#).



■ **The phase difference between channels during sync oscillation and 2-phase oscillation can be changed (WF1974 only)**

The difference between the phase setting of each channel is the phase difference between channels.

If [CH2 phase setting – CH1 phase setting] is positive, the waveform of CH2 is ahead of the waveform of CH1, as shown in the following figure.

For details on sync oscillation and 2-phase oscillation, see “3.3 Phase Synchronization Between Channels” and “3.4 Maintaining Both Channels to Same Frequency (2-Channel Ganged Operation, 2-Phase)” in the Application Instruction Manual.

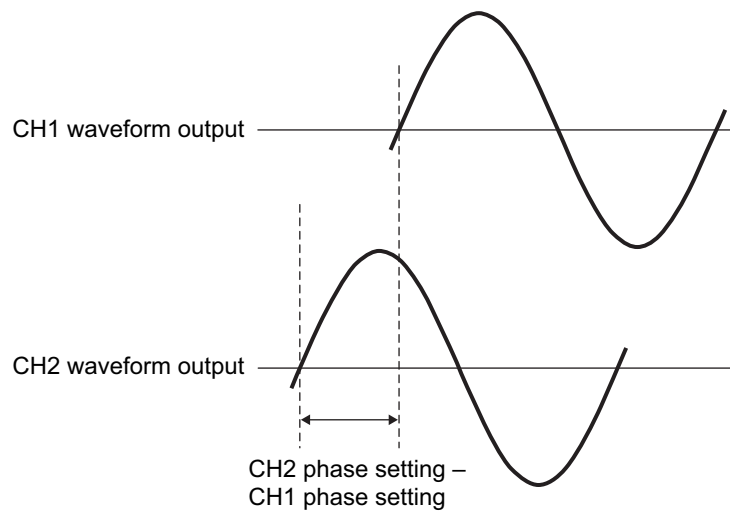

4.4.7 Setting the amplitude

a) Setting method

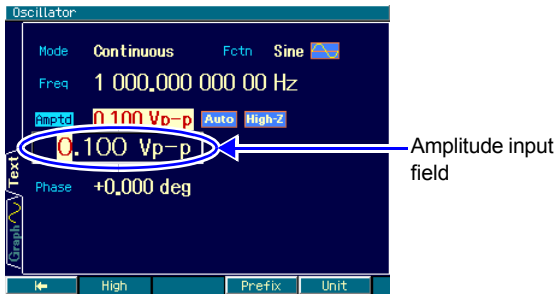

1. Press the **AMPTD** shortcut key to open the amplitude input field. Alternatively, select the [Amptd] field and then press the **ENTER** key to open the amplitude input field. Even if there are several setting screens, the [Amptd] field is always displayed on the first page. If [High] is displayed in the [Amptd] field and the high level instead of the amplitude is displayed, press the **AMPTD** key once more to switch to the amplitude display.

2. Select the digit to be changed with the **left/right arrow** keys, and increment/decrement the value with the **up/down arrow** keys or the **modify knob**. The change is instantly reflected to the output. Alternatively, enter a numeric value using the **numeric keypad**. Then press the **ENTER** key or one of the unit keys (soft keys) to set the input value and reflect it to the output.

b) Changing the unit (Vp-p, Vpk, Vrms, dBV, dBm, user-defined unit)

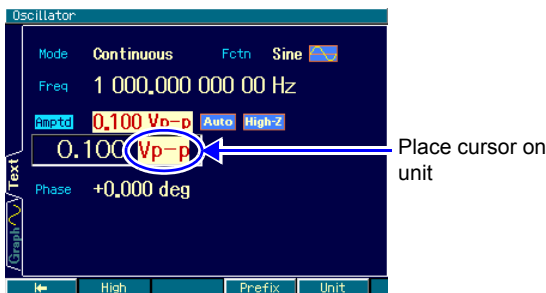

1. When the amplitude input field is open, press the **[Unit]** soft key and move the cursor to the unit position on the right end.

2. The unit can be changed with the **up/down arrow** keys or the **modify knob**. (Units that cannot be used are not displayed.) Even if the display unit is changed, the actual output value remains unchanged.

c) The units that can be used differ according to the waveform

Vp-p, Vpk, Vrms, dBV, dBm, and user-defined units can be used as the amplitude units. However, the applicable waveforms are limited as follows (not applicable to DC).

Unit	Applicable Waveform
Vp-p	Standard waveform and arbitrary waveform with amplitude range of $\pm FS$
Vpk	Standard waveform and arbitrary waveform with amplitude range of $0/+FS, -FS/0$
Vrms	Sine wave and noise
dBV	Sine wave and noise 1 Vrms = 0 dBV
dBm	Sine wave and noise Voltage of 1 mW set as 0 dBm for the specified load impedance (p. 55) Example: In the case of a load impedance setting of 50Ω , $0 \text{ dBm} = 223.6 \text{ mVrms}/50 \Omega$. Not usable when the load impedance setting is High-Z.
User-defined unit	All waveforms. For details on user-defined waveforms, see "7. USING USER-DEFINED UNITS" in the Application Instruction Manual.

d) AC+DC limitation

The maximum value for [AC amplitude + DC offset] is limited to ± 10 V/open.

For example, if the AC amplitude is 5 Vp-p/open, the DC offset range is limited to the range from -7.5 V/open to $+7.5$ V/open.

The maximum value varies according to the output voltage range setting and the external addition input setting.

☞ p. 54, p. 57

4.4.8 Setting DC offset

a) Setting method

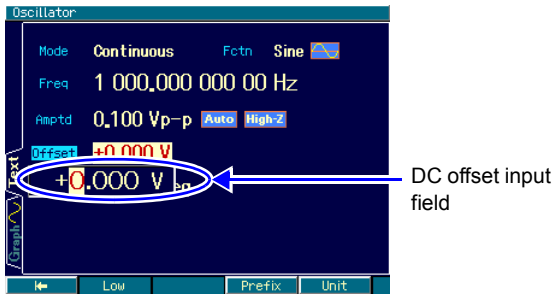

1. Press the **OFFSET** shortcut key to open the DC offset input field. Alternatively, select the [Offset] field and then press the **ENTER** ENTER key to open the DC offset input field.

Even if there are several setting screens, the [Offset] field is always displayed on the first page.

If [Low] is displayed in the [Offset] field and the low level instead of the offset is displayed, press the **OFFSET** OFFSET key once more to switch to the DC offset display.

2. Select the digit to be changed with the **◀▶** left/right arrow keys, and increment/decrement the value with the **⬆️⬇️** up/down arrow keys or the **⦿** modify knob. The change is instantly reflected to the output.
Alternatively, enter a numeric value using the **0...9** numeric keypad. Then press the **ENTER** ENTER key or one of the unit keys (soft keys) to set the input value and reflect it to the output.

b) AC+DC limitation

The maximum value for [AC amplitude + DC offset] is limited to ± 10 V/open.

For example, if the AC amplitude is 5 Vp-p/open, the DC offset range is limited to the range from -7.5 V/open to $+7.5$ V/open.

The maximum value varies according to the output voltage range setting and the external addition input setting.

☞ p. 54, p. 57

4.4.9 Setting the output level with high level/low level

The output level can be set by specifying the high level and low level of the waveform, instead of setting the amplitude and DC offset.

a) Changing the amplitude/DC offset display to high/low display

There are three methods for changing the amplitude/DC offset display to high/low display, described below.

○ Changing to high/low display with the [High] or [Low] soft key

When the amplitude or DC offset input field is open and the current value is displayed, the [High] or [Low] soft key is displayed. By pressing this key, the high level or low level input field opens, and the item displays change from [Amptd] and [Offset] to [High] and [Low], respectively.

The [High] or [Low] soft key changes to [Amptd] or [Offset]. When the [Amptd] or [Offset] soft key is pressed at this time, the amplitude or DC offset input field opens.

○ Changing to high/low display by pressing the **AMPTD** key twice

While the amplitude input field is not opened, press the **AMPTD** shortcut key twice to open the high level input field.

If the high level input field is open, the amplitude/DC offset display and high/low display are toggled each time the **AMPTD** key is pressed.

○ Changing to high/low display by pressing the **OFFSET** key twice

While the DC offset input field is not open, press the **OFFSET** shortcut key twice to open the low level input field.

If the low level input field is open, the amplitude/DC offset display and high/low display are toggled each time the **OFFSET** key is pressed.

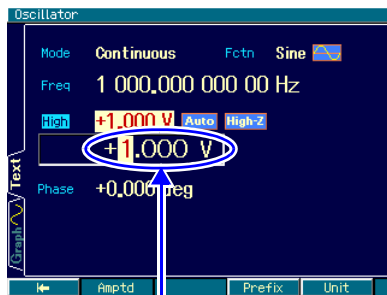

High level input field

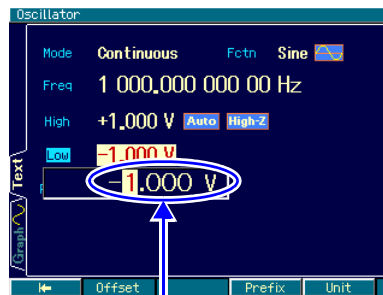

Low level input field

Once the high level or low level field is open, the setting procedure is the same as for DC offset.

When a numeric value is input from the numeric keypad, the high level/low level setting unit is displayed on a soft key.

The display changes as follows when the high level/low level display is switched to.

Item name: Amptd → High, Offset → Low

Unit display: Vp-p, Vpk, Vrms, dBV, dBm, V → V

Soft key: High → Amptd, Low → Offset

b) AC+DC limitation

The high level and low level are limited to the range of -10 V to +10 V/open.

The maximum range varies according to the output voltage range setting and the external

addition input setting.

p. 54, p. 57

4.4.10 Setting the waveform polarity and amplitude range

a) Setting method

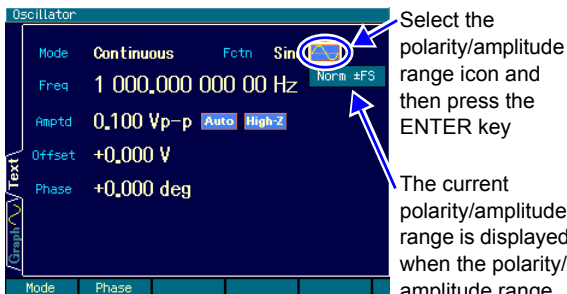

1. Select the polarity/amplitude range icon to the right of the waveform name to display the current polarity/amplitude range settings under that icon. Press the **ENTER** ENTER key to open the polarity/amplitude range choice list.

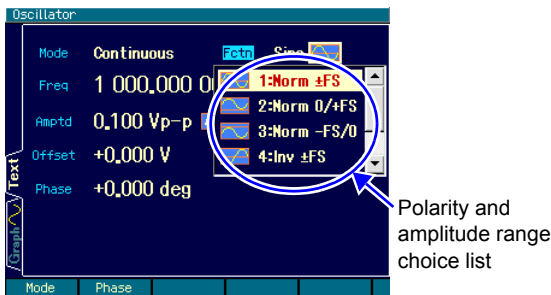

2. Select the desired polarity and amplitude range from the choice list and then press the **ENTER** ENTER key to set the input values and reflect them to the output. Alternatively, input the numbers corresponding to the desired polarity and amplitude range displayed in the choice list from the numeric keypad to set these values and reflect them to the output.

b) What are the polarity and amplitude range?

The polarity can be inverted and the amplitude range can be changed to a single polarity for each waveform. Examples for a sine wave are shown below.

Polarity	Amplitude Range		
	-FS/0	±FS	0/+FS
Normal [Norm]			
Inverted [Inv]			

In the case of polarity inversion, only the waveform is inverted, and the DC offset sign of the output remains unchanged.

Check
 The polarity and amplitude range settings are done independently for each waveform.

c) Amplitude range determination method

Determine the amplitude range by observing how the waveform changes when the amplitude is changed.

Under the initial settings, the waveform oscillating between the two polarities is set to $\pm FS$, while the unipolar waveform is set to $0/+FS$.

■ Example when amplitude range is $\pm FS$ for sine wave

When the amplitude is changed, the waveform amplitude changes in a $+/-$ symmetric manner with the DC offset position as reference.

Normally, in the case of a waveform that oscillates between the two polarities with zero as the center, it is convenient to set the amplitude range to $\pm FS$.

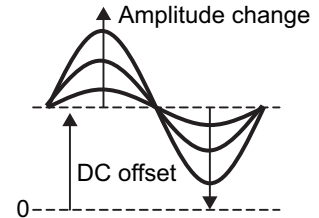

■ Example of Gaussian pulse with amplitude range of $0/+FS$

When the amplitude is changed, only the waveform amplitude is changed at the peak on the positive side, using the DC offset position as reference. The amplitude is changed using the bottom of the waveform as reference. Normally, in the case of a unipolar waveform, it is convenient to set the amplitude range to $0/+FS$ or $-FS/0$.

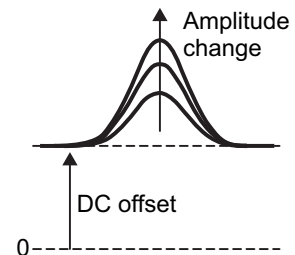

If the amplitude range is set to $-FS/0$, the amplitude changes using the top of the waveform as reference.

(Gaussian pulse is a waveform that is included in parameter-variable waveforms.)

d) Limitation through amplitude range

- If the amplitude range is $-FS/0$ or $0/+FS$, the maximum amplitude is one half of $\pm FS$.
- If the amplitude range is $-FS/0$ or $0/+FS$, this is equivalent to only the lower half or the upper half of the waveform memory being used. Therefore, the amplitude resolution is reduced by 1 bit compared to $\pm FS$.
- The amplitude setting when the amplitude setting is $\pm FS$ is V_{p-p} , and in the case of $-FS/0$ or $0/+FS$, it is V_{pk} . In either case, the amplitude refers to the peak-to-peak size of the waveform.

4.4.11 How to use auto range/range hold for the output voltage

Since auto range is set as part of the initial settings, the optimum range is automatically selected according to the amplitude and DC offset (including settings with high level and low level). A transient voltage is generated when the range is changed, but control is performed so that overvoltage does not result.

If the transient voltage generated as the result of range switching is not desirable, the range can be fixed. However, reducing the amplitude while the range is fixed lowers the amplitude accuracy and waveform quality.

a) Setting method

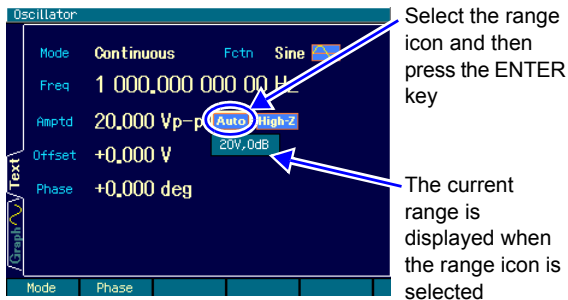

1. Select the range icon on the right of the amplitude display to display the current range under that icon. The current range is displayed as a combination of maximum output voltage Vp-p and the amplitude attenuator.

Press the **ENTER** key to open the range processing choice list.

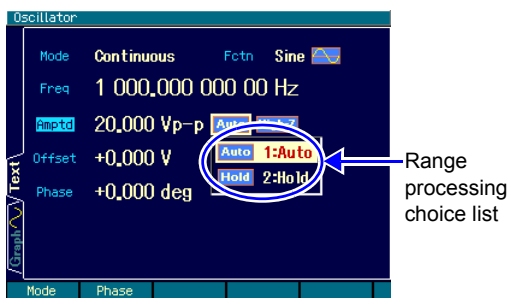

2. Auto range is selected when [Auto] is selected from the choice list, and when [Hold] is selected, the range is fixed to the range at that time. The respective range icons are displayed as "Auto" and "Hold". Select the desired range processing and then press the **ENTER** key.

b) Maximum values of amplitude and DC offset when range is fixed

When the range is fixed, the maximum values of the amplitude and DC offset, and the external addition gain are as listed in the following table.

Range (Maximum Output Voltage Vp-p, Amplitude Attenuator)	Maximum Value of Amplitude (Load Open Value)	Maximum Value of DC Offset (Load Open Value)	Maximum Value of AC+DC (Load Open Value)	External Addition Gain (±1 V Rating)
20 V, 0 dB	20 Vp-p	±10 V	±10 V	×10 or Off
20 V, -10 dB	6.325 Vp-p	±10 V	±10 V	×10 or Off
20 V, -20 dB	2 Vp-p	±10 V	±10 V	×10 or Off
20 V, -30 dB	0.6325 Vp-p	±10 V	±10 V	×10 or Off
4 V, 0 dB	4 Vp-p	±2 V	±2 V	×2 or Off
4 V, -10 dB	1.265 Vp-p	±2 V	±2 V	×2 or Off
4 V, -20 dB	0.4 Vp-p	±2 V	±2 V	×2 or Off
4 V, -30 dB	0.1265 Vp-p	±2 V	±2 V	×2 or Off

4.4.12 Setting the load impedance

When the load impedance setting value is made the same as the actual load condition, the amplitude and DC offset (including setting with high level, low level) can be set with the voltage value that appears at load end.

The load impedance value can be set in the range of 1 Ω to 10 kΩ, 50 Ω, or open (High-Z).

However, even if the load impedance setting value is changed, only the displayed amplitude setting value and DC offset setting value change, and the load-open output voltage remains unchanged.

a) Setting method

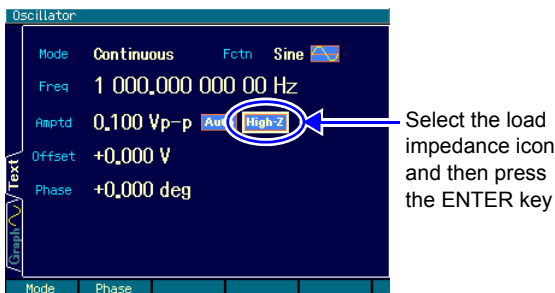

1. Select the load impedance icon on the right of the range icon and then press the **ENTER** ENTER key.

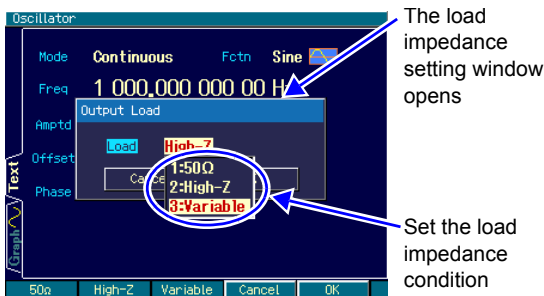

2. The load impedance setting window opens, so press the **ENTER** ENTER key again.

The load impedance condition choice list opens. Select the desired load impedance and then press the **ENTER** ENTER key. When [Variable] is selected, the load impedance value can be set.

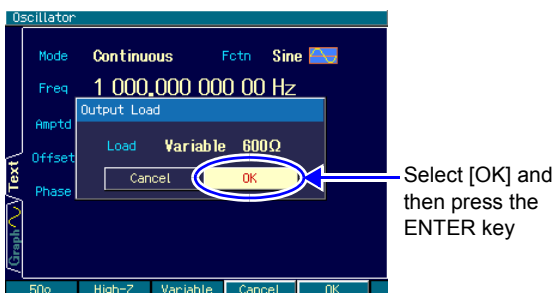

3. Once the load impedance setting has been completed, select [OK] in the lower part of the window and then press the **ENTER** ENTER key to apply the load impedance setting change and close the window.

To not change the load impedance setting, select [Cancel] in the lower part of the window and then press the **ENTER** ENTER key, or press the **CANCEL** CANCEL key.

b) Conversion formula

Conversion is done with the following formula.

Load impedance setting value: R_{load} (Ω)

Load-open output voltage: V_{open}

Output voltage setting value (load-end voltage): V_{load}

$$V_{load} = \frac{R_{load}}{50 + R_{load}} \times V_{open}$$

✓ **Check**

- The output impedance is constant at 50 Ω .
- The output impedance error and output voltage error are not corrected.
The output voltage accuracy specification is the load-open value.

4.4.13 Adding external signal

An external signal can be added to the waveform output of this equipment.

a) Connecting the addition signal

Connect the addition signal to the external modulation/addition input (MOD/ADD IN) BNC terminal on the front panel and the rear panel in the WF1973 and WF1974, respectively.

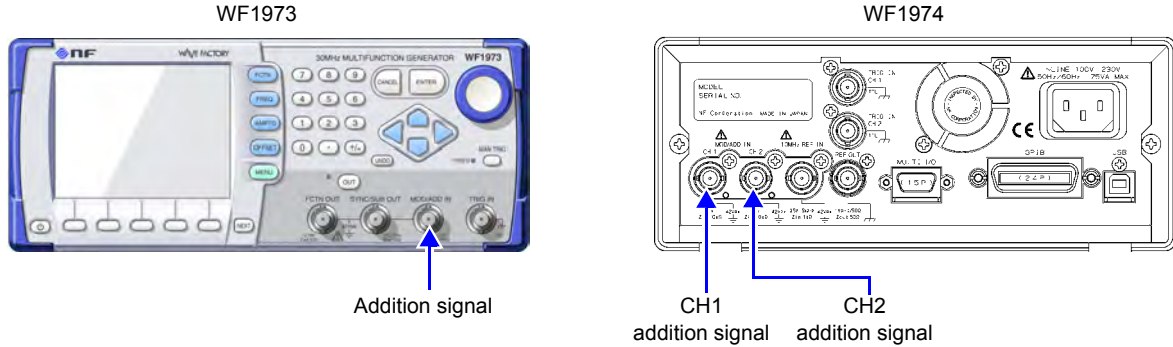

For the input characteristics, see p. 14.

This BNC terminal is insulated from the housing and has the same ground potential as the waveform output of the same channel. For the floating ground connection, see p. 19.

b) Enabling the addition signal

The external addition setting is done on the Utility screen.

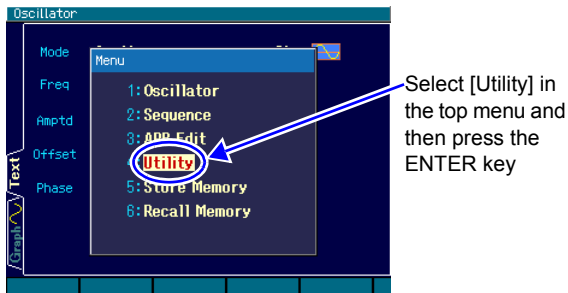

1. Press the **MENU** MENU key to open the top menu window. There, select [Utility] and then press the **ENTER** ENTER key to display the Utility screen.

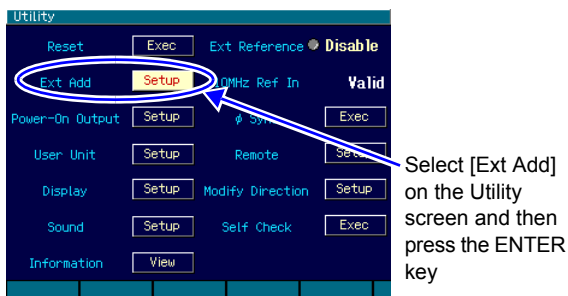

2. On the Utility screen, select the [Ext Add] field and then press the **ENTER** ENTER key.

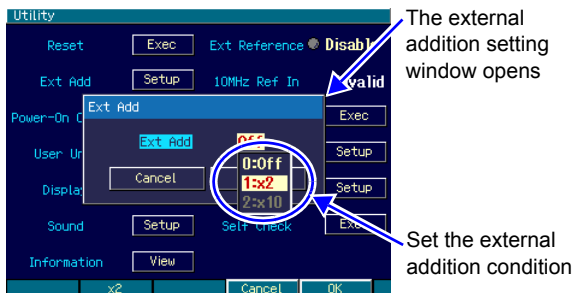

3. The external addition setting window opens, so select the desired item and then press the **ENTER** ENTER key. The external addition condition choice list opens, so select the desired condition and then press the **ENTER** ENTER key. [x2] and [x10] represent the addition gain.

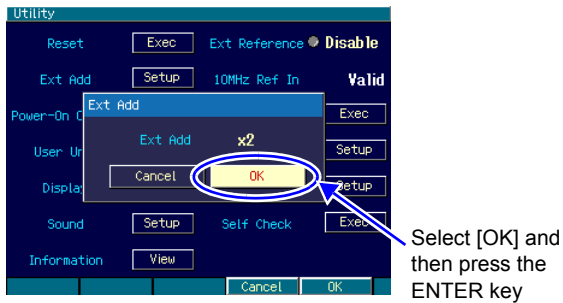

4. Once the external addition settings have been completed, select [OK] in the lower part of the window and then press the **[ENTER]** ENTER key to apply the external addition setting change and close the window.

To not change the external addition setting, select [Cancel] in the lower part of the window and then press the **[ENTER]** ENTER key, or press the **[CANCEL]** CANCEL key.

c) When the desired external addition condition cannot be selected

■ When the external addition cannot be set on (×2, ×10 setting)

External modulation is used.

To use external addition, change the modulation source to the internal source.

The external addition input terminal is shared with the external modulation input terminal. Therefore, when an external modulation source is specified for modulated oscillation except FSK and PSK, external addition cannot be used. The external addition setting is always [Off] at such time.

Similarly, when external addition is used, external modulation cannot be used (except FSK, PSK).

■ When the external addition gain cannot be set to the desired value

The external addition gain is determined by the output voltage range.

To set the external addition gain to ×2, set the amplitude and DC offset so that the output voltage range is 4 V.

To set the external addition gain to ×10, set the amplitude and DC offset so that the output voltage range is 20 V.

Since external addition is done at the last stage of waveform output (☞ p. 2), the addition gain is closely related to the output voltage range. When the maximum output voltage of the range is 20 V and 4 V, the addition gain is fixed to ×10 and ×2, respectively. Other addition gain values cannot be selected. ☞ p. 54

Conversely, when external addition is used, the maximum output voltage of the range is fixed according to the addition gain. It should be noted in particular that when the addition gain is ×10, the maximum output voltage is fixed to 20 V, so that the amplitude accuracy and waveform quality may decline when the amplitude is made smaller.

4.4.14 Setting the square wave duty

The waveform is assumed to be set to [Square]. For the waveform setting method, see p. 44. The duty setting unit is % only. Setting and display using time is not possible.

a) Duty setting method

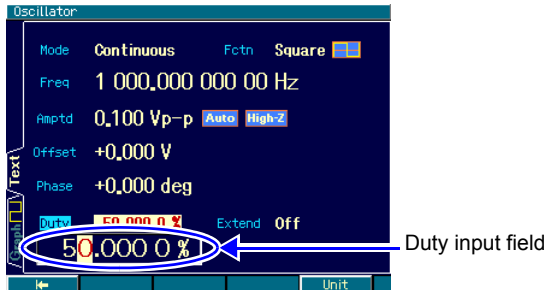

1. Select the [Duty] field and then press the **ENTER** ENTER key to open the duty input field.

Even if there are several setting screens, the [Duty] field is always displayed on the first page.

2. Select the digit to be changed with the **◀▶** left/right arrow keys, and increment/decrement the value with the **⬆️⬇️** up/down arrow keys or the **⦿** modify knob. The change is instantly reflected to the output.

Alternatively, enter a numeric value using the **0...9** numeric keypad. Then press the **ENTER** ENTER key or the [%] unit key (soft key) to set the input value and reflect it to the output. If the ENTER key is used, the unit is set to %.

b) Variable duty range switching method

Normally, use [Off] (normal range).

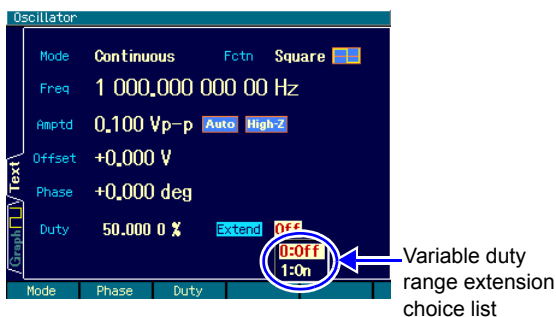

1. Select the [Extend] field and then press the **ENTER** ENTER key to open the variable duty range extension on/off choice list.

Even if there are several setting screens, the [Extend] field is always displayed on the first page.

2. Select the desired condition from the choice list and then press the **ENTER** ENTER key to apply the setting and reflect it to the output.

The desired condition can also be set and reflected to the output by inputting the number of the desired condition displayed in the choice list from the numeric keypad.

The desired condition can also be set by inputting a number from the numeric keypad while the [Extend] field is selected (without the choice list displayed).

c) Difference between normal and extended variable duty range

Variable Range	Characteristics
Normal	Setting range: 0.0100% to 99.9900% <ul style="list-style-type: none"> • Range in which the duty can be changed with little jitter and no pulse loss • The higher the frequency, the narrower the duty setting range. • At 15 MHz, the duty is fixed to 50%.
Extended	Setting range: 0.0000% to 100.0000% (independent of the frequency) <ul style="list-style-type: none"> • Jitter of 2.5 ns rms or less typ., duty can always be changed from 0% to 100%. • If the high-level or low-level pulse width is less than 8.4 ns, the <u>pulse may at times vanish</u>. However, on average, the duty is equivalent to the set duty. • When 0% is set, the waveform is fixed on the low-level side, and when 100% is set, it is fixed to the high-level side. In either case, the pulse stops being output.

d) Duty and frequency limitations for standard variable duty range

The duty setting range is limited to the following range according to the frequency.

$$\text{Frequency (Hz)} / 300,000 \leq \text{Duty (\%)} \leq 100 - \text{Frequency (Hz)} / 300,000$$

For example, the variable range at 3 MHz is limited to 10% to 90%.

If the above limitation according to the frequency setting is not satisfied, the duty is adjusted.

 **Check**

In the case of the extended variable duty range, the pulse may at times vanish, and thus the frequency may become lower than the set frequency. Do not use the extended variable duty range for applications that require that a constant frequency be maintained.

4.4.15 Setting the pulse width and leading/trailing edge time of a pulse wave

The waveform is assumed to be set to [Pulse]. For the waveform setting method, see p. 44.

The pulse width can be set either with time or duty.

The leading and trailing edge times can be set only with time.

a) Pulse width time setting method

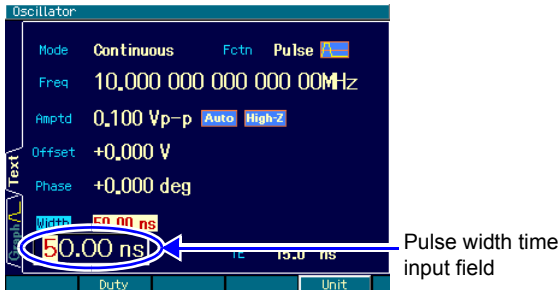

1. Select the [Width] field and then press the **ENTER** ENTER key to open the pulse width time input field.

Even if there are several setting screens, the [Width] field is always displayed on the first page.

If [Duty] is displayed in the [Width] field and the pulse width duty and not the pulse width time is displayed, press the [Width] soft key if the duty input field is open to switch to the pulse width time display.

2. Select the digit to be changed with the **◀▶** left/right arrow keys, and increment/decrement the value with the **⬆️⬇️** up/down arrow keys or the **⦿** modify knob. The change is instantly reflected to the output.

Alternatively, enter a numeric value using the **0...9** numeric keypad. Then press the **ENTER** ENTER key or the unit key (soft key) to set the input value and reflect it to the output. If the ENTER key is used, the unit is set to s.

b) Pulse width duty setting method

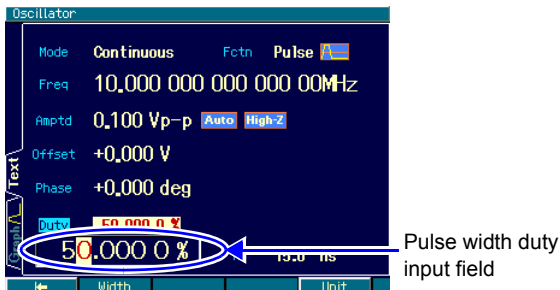

1. Select the [Duty] field and then press the **ENTER** ENTER key to open the pulse width duty input field.

Even if there are several setting screens, the [Duty] field is always displayed on the first page.

If [Width] is displayed in the [Duty] field and the pulse width time and not the pulse width duty is displayed, press the [Duty] soft key if the time input field is open to switch to the pulse width duty display.

2. Select the digit to be changed with the **◀▶** left/right arrow keys, and increment/decrement the value with the **⬆️⬇️** up/down arrow keys or the **⦿** modify knob. The change is instantly reflected to the output.

Alternatively, enter a numeric value using the **0...9** numeric keypad. Then press the **ENTER** ENTER key or the [%] unit key (soft key) to set the input value and reflect it to the output. If the ENTER key is used, the unit is set to %.

c) Switching the pulse width time and pulse width duty

○ Pulse width time → Pulse width duty

When the pulse width time input field is open and the current pulse width time is displayed, the [Duty] soft key is displayed. Press this key to open the pulse width duty input field and change the item display from [Width] to [Duty]. The [Duty] soft key changes to [Width].

○ Pulse width duty → Pulse width time

When the pulse width duty input field opens and the current pulse width duty is displayed, the [Width] soft key is displayed. Press this soft key to open the pulse width time input field and change the item display from [Duty] to [Width]. The [Width] soft key changes to [Duty].

d) Difference between pulse width time setting and duty setting

The following operation differences exist depending on whether the pulse width is set with time or duty.



e) Leading edge time and trailing edge time setting method

The leading edge time [LE] and trailing edge time [TE] can be set only with time.

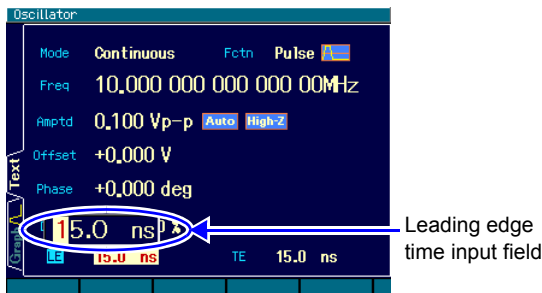

1. To set the leading edge time, select the [LE] field and then press the **ENTER** key to open the leading edge time input field.

To set the trailing edge time, select the [TE] field and then press the **ENTER** key to open the trailing edge time input field.

Even if there are several setting screens, the [LE] and [TE] fields are displayed on each page.

2. Select the digit to be changed with the **◀▶** left/right arrow keys, and increment/decrement the value with the **⬆️⬇️** up/down arrow keys or the **⦿** modify knob. The change is instantly reflected to the output. Alternatively, enter a numeric value using the **0...9** numeric keypad. Then press the **ENTER** key or a unit key (soft key) to set the input value and reflect it to the output. If the **ENTER** key is used, the unit is set to s.

f) Pulse width, leading edge time, and trailing edge time definitions and limitations

The pulse width, leading edge time, and trailing edge time are defined as shown in the following figure.

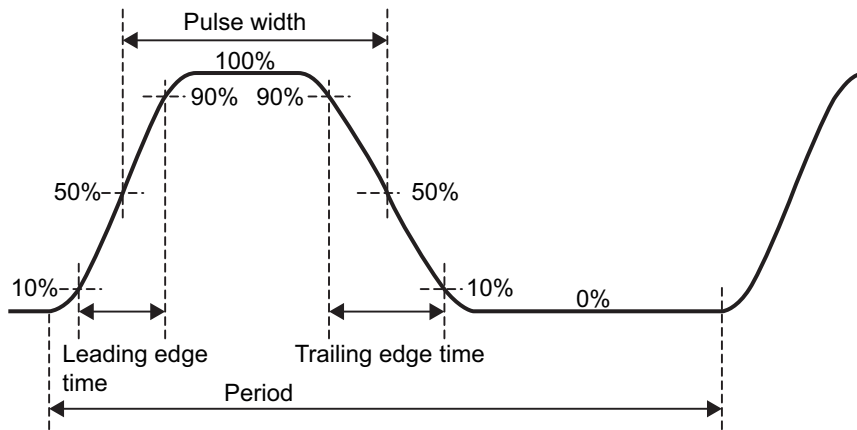

However, the setting ranges of the pulse width, leading edge time, trailing edge time, and frequency are mutually limited as follows.

If the following limitations are not met by the frequency or pulse width setting, the leading edge time and trailing edge time are adjusted first, and the pulse width is adjusted next.

■ Leading edge time and trailing edge time limitations

The ranges of the leading edge time, trailing edge time, and frequency or cycle are limited as follows.

$$\begin{aligned} \text{Largest of } 0.01\% \text{ of period or } 15 \text{ ns} &\leq \text{Leading edge time} \\ \text{Largest of } 0.01\% \text{ of period or } 15 \text{ ns} &\leq \text{Trailing edge time} \end{aligned}$$

For example, the leading edge time and trailing edge time at 1 kHz are limited to 100 ns or more.

■ Pulse width, leading edge time, and trailing edge time limitations

The ranges of the pulse width time, leading edge time, trailing edge time, and frequency or cycle are limited as follows. If the pulse width is set with duty, the value converted to time is used as the pulse width time.

$$\left(\text{Leading edge time} + \text{trailing edge time} \right) \times 0.85 \leq \frac{\text{Pulse width}}{\text{time}} \leq \text{Period} - \left(\text{Leading edge time} + \text{trailing edge time} \right) \times 0.85$$

For example, when the leading edge time and the trailing edge time are each set to 100 ns at 1 kHz, the pulse width time can vary in the range of 170 ns to 999.83 μ s.

4.4.16 Setting the ramp wave symmetry

The waveform is assumed to be set to [Ramp] (ramp wave). For the waveform setting method, see p. 44.

The symmetry setting unit is % only. Setting and display with time is not possible.

a) Symmetry setting method

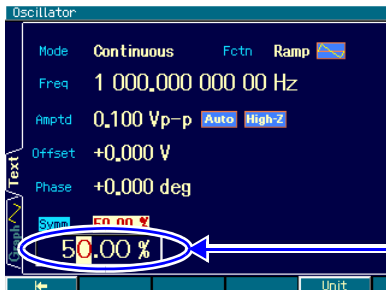

1. Select the [Symm] field and then press the **ENTER** key to open the symmetry input field.

Even if there are several setting screens, the [Symm] field is always displayed on the first page.

2. Select the digit to be changed with the left/right arrow keys, and increment/decrement the value with the up/down arrow keys or the modify knob. The change is instantly reflected to the output.

Alternatively, enter a numeric value using the numeric keypad. Then press the **ENTER** key or the [%] unit key (soft key) to set the input value and reflect it to the output. If the ENTER key is used, the unit is set to %.

b) Relationship between symmetry and waveform

One waveform cycle changes as follows according to the symmetry setting. A symmetry is expressed by the amount of the ratios of the first and second rises. Except in the case of 0% symmetry, the phase zero position is fixed to the 0 amplitude center position.

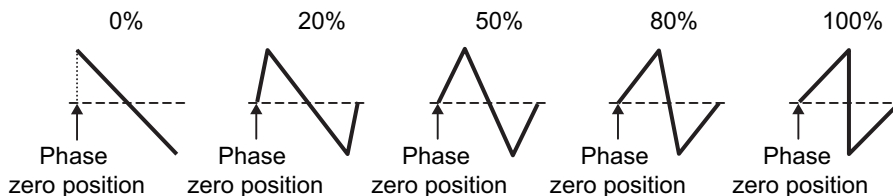

If it is preferable for the phase zero position to be at the bottom of the waveform, use the bottom referenced ramp wave of a parameter-variable waveform. See “1.2.7 Other waveform group” in the Application Instruction Manual

Example of 20% and 80% symmetry for bottom referenced ramp wave

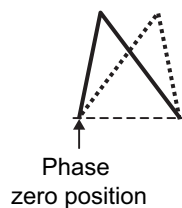

4.5 Using Parameter-Variable Waveforms

a) Outputting a parameter-variable waveform

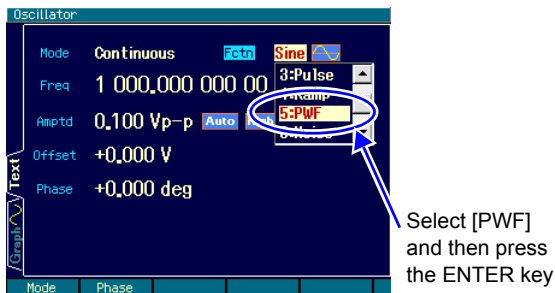

Select the [PWF] parameter-variable waveform in the [Fctn] field and then press the **ENTER** ENTER key.

The waveform that is currently set as the parameter-variable waveform is output. Like for other waveforms, the polarity and amplitude range of the waveform can also be changed.

b) Changing the waveform of a parameter-variable waveform

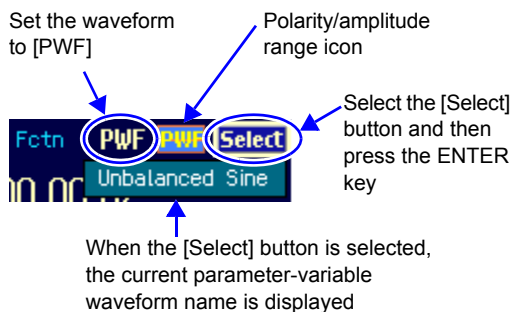

1. When the waveform is set to [PWF] (parameter-variable waveform), the [Select] button is displayed to the right of the polarity/amplitude range icon. When this button is selected, the currently selected parameter-variable waveform name is displayed. Press the **ENTER** ENTER button to display the parameter-variable waveform selection screen.

2. The parameter-variable waveform setting and various parameter settings can be done in the parameter-variable waveform selection screen. "Oscillator > PWF Select" is displayed in the top left part of the parameter-variable waveform selection screen.

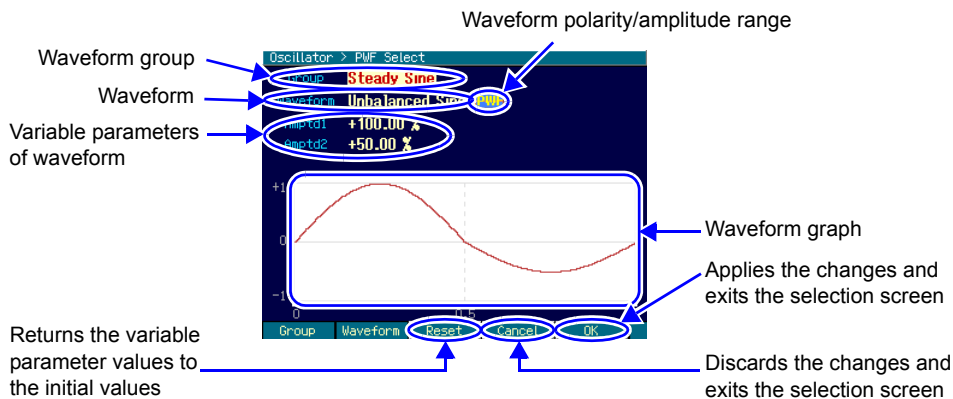

Due to the large number of parameter-variable waveforms, they are categorized into a number of different groups.

First, select the desired group in the [Group] field.

Next, in the [Waveform] field, set the desired waveform from the various waveforms listed within the selected group.

Set the polarity and amplitude range of the waveform with the polarity/amplitude range icon. These settings are done independently for each waveform, and can be changed even when the selection screen has been exited.

Each waveform has up to 5 specific parameters. Set the desired value for each one of these parameters.

To return the variable parameter values to their initial value, press the [Reset] soft key. The change is instantly reflected to the output waveform, and the shape of the set waveform is displayed in graph form.

For details on the variable parameters, refer to “1. DETAILS OF PARAMETER-VARIABLE WAVEFORMS” in the Application Instruction Manual.

- 3.** To apply the changes and quit the selection screen, press the [OK] soft key.
To discard the changes and quit the selection screen, press the [Cancel] soft key.
The changes can also be applied and the selection screen exited by pressing a basic parameter shortcut key.

 **Check**

The waveform may disappear according to the parameter settings.
If you do not know how to restore the waveform display, press the [Reset] soft key. This will return each parameter value to the factory default. The polarity and amplitude range remain unchanged.

4.6 Using Arbitrary Waveforms

a) Outputting an arbitrary waveform

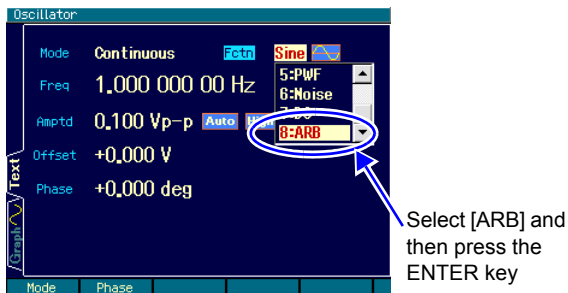

Select [ARB] (arbitrary waveform) in the [Fctn] field and then press the **ENTER** key.

The currently set arbitrary waveform is output.

Like for other waveforms, the polarity and amplitude range of the waveform can also be changed.

b) Changing the waveform of an arbitrary waveform

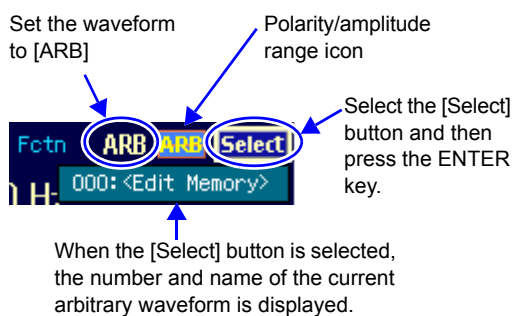

1. When the waveform is set to [ARB] (arbitrary waveform), the [Select] button is displayed to the right of the polarity/amplitude range icon.

When this button is selected, the currently selected arbitrary waveform name is displayed.

Press the **ENTER** button to display the screen for selecting currently saved arbitrary waveforms.

2. Arbitrary waveform selection and name change can be done on the arbitrary waveform selection screen. "Oscillator > ARB Select" is displayed in the top left part of the arbitrary waveform selection screen.

Set the number of the waveform in the [ARB No.] field. The waveform can be selected from waveform No. 0 saved in volatile editing memory and the waveforms No. 1 to No. 128 saved in non-volatile memory. The outline of the selected waveform can be checked with the graph display. The [Type] field shows the arbitrary waveform data format, and the [Size] field shows the memory size used for saving data.

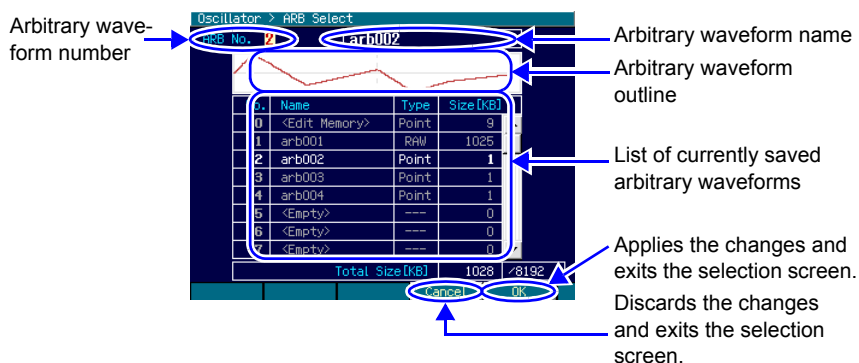

The changes are not reflected to the output waveform until applied by pressing the [OK] soft key (the operation differs from that for parameter-variable waveforms).

Arbitrary waveforms cannot be created on this screen. For how to create arbitrary waveforms, data format, and memory size, see "2. CREATING ARBITRARY WAVEFORMS" in the Application Instruction Manual.

The name changing method is the same as for the setting memory. Names of up to 20 characters can be set. See p. 123

- 3.** To apply the changes and quit the selection screen, press the [OK] soft key.
To discard the changes and quit the selection screen, press the [Cancel] soft key.
The changes can also be discarded and the selection screen exited by pressing a basic parameter shortcut key (the operation differs from that in the parameter-variable waveform selection screen).

4.7 Modulation Setting and Manipulation

4.7.1 Modulation types

The following eight types of modulation can be done.

- FM: Frequency Modulation ☞ p. 75
- FSK: Frequency Shift Keying
This is binary frequency shift modulation. ☞ p. 76
- PM: Phase Modulation ☞ p. 77
- PSK: Phase Shift Keying
This is binary phase shift modulation. ☞ p. 78
- AM: Amplitude Modulation ☞ p. 79
- AM(DSB-SC): Amplitude Modulation (Double Side Band – Suppressed Carrier)
This is AM that does not include the carrier frequency component. ☞ p. 80
- DC offset modulation ☞ p. 81
- PWM: Pulse Width Modulation ☞ p. 82

4.7.2 Screen for modulation setting and manipulation

This subsection describes the screen configuration used in common for the modulated oscillation mode.

The settings and manipulations are done on the Oscillator setting screen. The Oscillator setting screen is displayed as “Oscillator” in the top left part of the screen. When another screen is displayed, press the **MENU** key to display the top menu, then select [Oscillator] and press the **ENTER** key.

a) Setting the oscillation mode to modulations

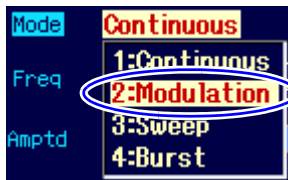

Select [Modulation] in [Mode] and then press the **ENTER** key

Set [Mode] (oscillation mode) to [Modulation] on the Oscillator setting screen. The oscillation mode is switched to modulation as a result.

In the modulated oscillation mode, the setting screen consists of two pages, which can be toggled with the **NEXT** key.

b) 1st page of setting screen: Screen for setting the carrier signal

This is the modulation carrier signal setting screen, which is common to all the oscillation modes.

Set the oscillation mode to [Modulation]

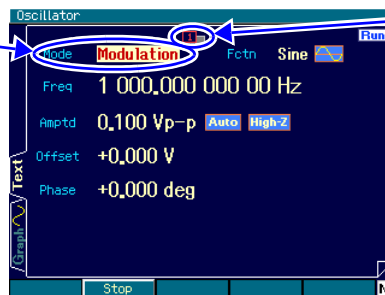

Indicates that the 1st page is displayed

Press the **NEXT** key to display the 2nd page

c) 2nd page of setting screen: Screen for setting the modulation

The figure shows an example of selecting FM as the modulation type.

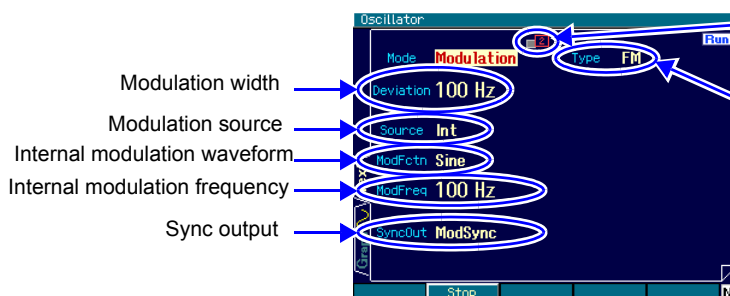

Indicates that the 2nd page is displayed

Modulation type

Press the **NEXT** key to display the 1st page

Modulation type [Type]

This is the type of modulation. FM, FSK, PM, PSK, AM, AM (DSB-SC), DC offset modulation, and PWM can be chosen from. [☞ p. 72](#)

Modulation width [Deviation, Depth, HopFreq]

This is the modulation width. The name of this item differs according to the modulation type. [☞ p. 72](#)

Modulation source [Source]

Either an internal or external modulation source can be selected. [☞ p. 72](#)

Internal modulation waveform [ModFctn]

This is the internal modulation source waveform. Sine, square, triangular, rising ramp, falling ramp, noise, and arbitrary can be chosen from. [☞ p. 72](#)

Internal modulation frequency [ModFreq]

This is the frequency of the internal modulation source. [☞ p. 72](#)

Sync output [SyncOut]

This is the output signal from the sync/sub-output terminal. Waveform basic phase sync, internal modulation sync, and internal modulation waveform can be chosen from. [☞ p. 74](#)

4.7.3 Common modulation settings and manipulations

This subsection describes the settings and manipulations that are common to all types of modulation.

a) To set the oscillation mode to modulation → Oscillation mode setting

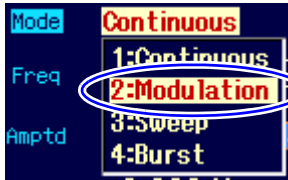

Select [Modulation] in [Mode] and then press the ENTER key

On the Oscillator setting screen, set [Mode] (oscillation mode) to [Modulation]. This changes the mode to the modulated oscillation mode.

In the modulated oscillation mode, the setting screen consists of two pages, which can be toggled with the **◀ NEXT** key.

b) To select the modulation type → Modulation type setting

The following eight modulation types can be selected in [Type] (modulation type) on the 2nd page of the setting screen.



Modulation type

- FM[FM] ☞ p. 75
- FSK[FSK] ☞ p. 76
- PM[PM] ☞ p. 77
- PSK[PSK] ☞ p. 78
- AM[AM] ☞ p. 79
- AM(DSB-SC)[AM(SC)] ☞ p. 80
- DC offset modulation [OFSM] ☞ p. 81
- PWM[PWM] ☞ p. 82

c) To set the carrier condition

Set the various parameters of the carrier signal on the 1st page of the setting screen.

d) To set the modulation width

The modulation width setting is done on the 2nd page of the setting screen. The item name that is displayed is either [Deviation], [Depth], or [HopFreq], depending on the modulation type.

For details, refer to the description of each modulation type.

e) To perform modulation with the internal signal source

Set [Source] (modulation source) on the 2nd page of the setting screen to [Int] (internal). [ModFctn] (internal modulation waveform) and [ModFreq] (internal modulation frequency) must also be set.

[ModFctn] (internal modulation waveform) can be selected from the following seven choices.

- Sine [Sine]
- Square (50% duty) [Square]
- Triangle (50% symmetry) [Triangle]
- Rising ramp [UpRamp]
- Falling ramp [DnRamp]
- Noise [Noise]
- Arbitrary [ARB]

The internal modulation frequency cannot be set if the internal modulation waveform is noise.

If the modulation type is FSK or PSK, the internal modulation waveform is fixed to a 50% duty square wave, and the internal modulation waveform cannot be selected.

When an arbitrary waveform is selected for the internal modulation waveform, waveform data simply decimated to 4096 points from the start is used as the modulation waveform in case of the array format. When [RAW] is shown in the [Type] field in the arbitrary waveform selection screen, the arbitrary waveform is in the array format. If the value in the [Size] field is 17 KB or more, the original waveform size is larger than 4096 points. On the other hand, when [Point] is shown in the [Type] field, the arbitrary waveform is in the control point format. The arbitrary waveform in this format, the waveform is developed using 4096 points to maintain the waveform characteristics as much as possible. For details on the arbitrary waveforms, see “2. CREATING ARBITRARY WAVEFORMS” in the Application Instruction Manual.

f) To perform modulation with an external signal source

Set [Source] (modulation source) on the 2nd page of the setting screen to [Ext] (external).

The external modulation signal input terminal differs as follows according to the modulation type.

■ When the modulation type is FM, PM, AM, AM(SC), OSFM, or PWM

Input the modulation signal to the external modulation/addition input terminal. The modulation width setting is the value when the signal level is ± 1 V. If the input level is lower than ± 1 V, keep it mind that the modulation width may become below the specified modulation width.

When the external modulation/addition input terminal is used for external addition input, the external modulation function cannot be used.

■ When the modulation type is FSK or PSK

Input the modulation signal (TTL level) to the external trigger input terminal.

The polarity can be set on the screen.

g) To start modulation → Modulation starts automatically. Resume with the [Start] soft key.

When the modulated oscillation mode is set, modulated oscillation starts automatically.

However, if the modulation setting is improper, modulated oscillation will not start. ([Conflict!] is displayed in the top right part of the screen in this case.) When the [?] soft key appearing at the left end is pressed, a message about the inappropriate setting is displayed. Once the setting has been changed to an appropriate setting, modulated oscillation starts.

When modulation has been paused, it can be resumed by pressing the [Start] soft key.

h) To stop modulation → [Stop] soft key

Modulation can be paused.

When the [Stop] soft key is pressed during modulation, modulation stops and the carrier signal is output without being modulated. The oscillation mode remains the modulated oscillation mode.

i) To output modulation sync signal, modulation waveform signal → Sync output setting

Perform the sync output setting with [SyncOut] (sync output) on the 2nd page of the setting screen. The sync output setting can be chosen from the following three.

- Signal synchronized with reference phase of waveform [Sync]
- Signal synchronized with internal modulation waveform [ModSync]
- Internal modulation waveform [ModFctn]

■ When [Sync] is selected

A TTL level signal that rises at the reference phase of the waveform is output from the sync/sub-output terminal.

■ When [ModSync] is selected

A TTL level signal synchronized with the internal modulation waveform is output from the sync/sub-output terminal. This is a 50% duty square wave that rises at the zero phase position of the internal modulation waveform. If the internal modulation waveform is noise, it is fixed to low level.

When the signal being modulated is observed with an oscilloscope, it can be used as the trigger signal for the oscilloscope.

■ When [ModFctn] is selected

The internal modulation waveform is output from the sync/sub-output terminal. The signal level is ± 3 V/open.

[ModFctn] cannot be selected when the modulation type is FSK or PSK.

4.7.4 Setting FM

The output frequency varies according to the instantaneous value of the modulation signal.
For the manipulation methods that are common with the modulation setting screen, refer to pp. 70 and 72.

a) FM example

Frequency shifting of the output signal grows larger when the modulation signal swings to the positive side.

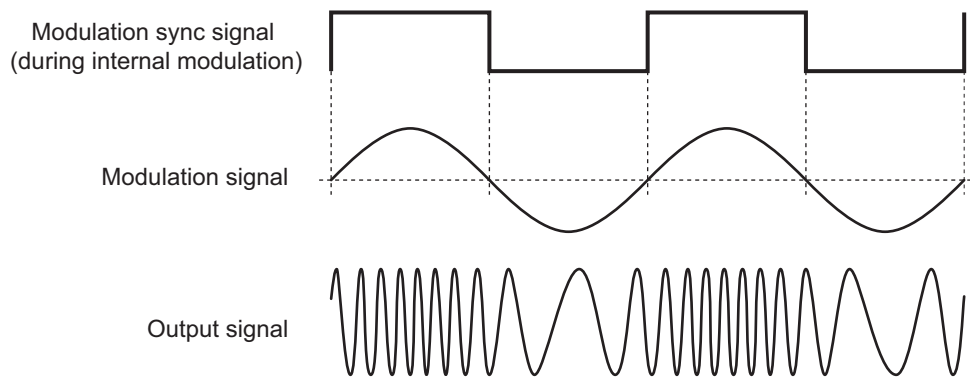

b) Selecting FM

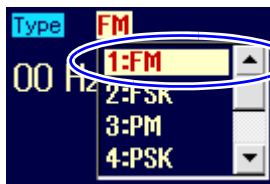

Select [FM] in [Type] and then press the ENTER key

When [Mode] (oscillation mode) is set to [Modulation], set [Type] (modulation type) on the 2nd page of the setting screen to [FM] (FM).

c) Waveforms for which FM is not possible

FM is not possible for noise, pulse wave, and DC.

d) Setting items required for FM

Set [Freq] (carrier frequency) on the 1st page of the setting screen.

Set [Deviation] (peak frequency deviation) on the 2nd page of the setting screen.

The output frequency varies according to the range of carrier frequency \pm peak frequency deviation.

If [Source] (modulation source) is set to [Int] (internal), set [ModFctn] (modulation waveform) and [ModFreq] (modulation frequency).

If [Source] (modulation source) is set to [Ext] (external), input the modulation signal to the external modulation/addition input terminal. In the case of ± 1 V input, the prescribed peak frequency deviation results.

4.7.5 Setting FSK

This is binary frequency shift modulation by which the output frequency switches between the carrier frequency and hop frequency according to the modulation signal.

For the manipulation methods that are common with the modulation setting screen, refer to pp. 70 and 72.

a) FSK example

The frequency changes suddenly, but the phase continuity of the output signal is maintained.

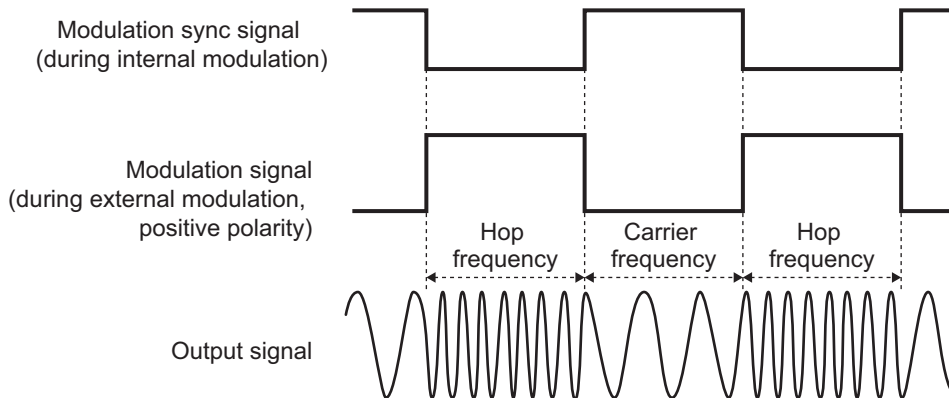

b) Selecting FSK

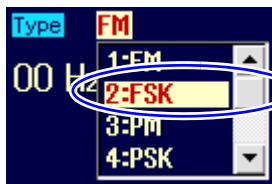

Select [FSK] in [Type] and then press the ENTER key

When [Mode] (oscillation mode) is set to [Modulation] (modulation), set [Type] (modulation type) on the 2nd page of the setting screen to [FSK] (FSK).

c) Waveforms for which FSK is not possible

FSK is not possible for noise, pulse wave, and DC.

d) Setting items required for FSK

Set [Freq] (carrier frequency) on the 1st page of the setting screen.

Set [HopFreq] (hop frequency) on the 2nd page of the setting screen.

The output frequency alternates between the carrier frequency and the hop frequency.

If [Source] (modulation source) is [Int] (internal), set [ModFreq] (modulation frequency).

If [Source] (modulation source) is [Ext] (external), set the trigger polarity and input the modulation signal (TTL level) to the external trigger input terminal. If the polarity is set to [High] (positive), the carrier frequency is output during low-level input, and the hop frequency is output during high-level input, and vice versa if the polarity is set to [Low].

4.7.6 Setting PM

The output phase varies according to the instantaneous value of the modulation signal.

For the manipulation methods that are common with the modulation setting screen, refer to pp. 70 and 72.

a) PM example

Phase shifting of the output signal grows larger when the modulation signal swings to the positive side.

Since the phase changes along with time, the instantaneous frequency also changes simultaneously.

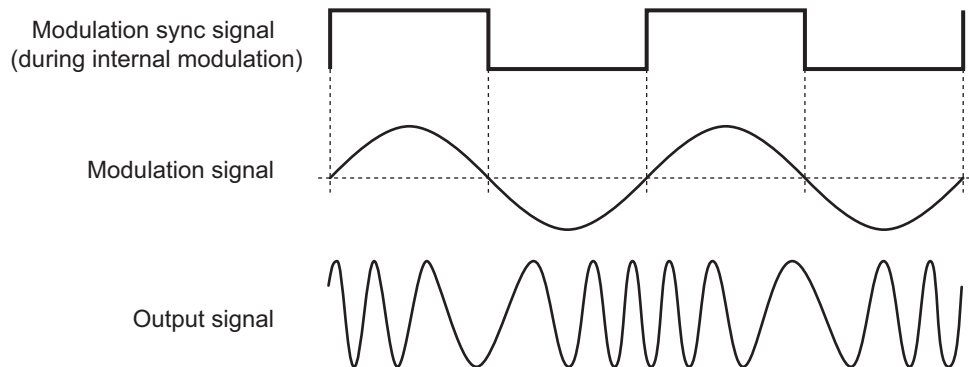

b) Selecting PM

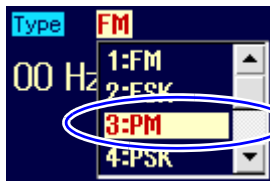

Select [PM] in [Type] and then press the ENTER key

When [Mode] (oscillation mode) is set to [Modulation], set [Type] (modulation type) on the 2nd page of the setting screen to [PM] (PM).

c) Waveforms for which FM is not possible

PM is not possible for noise and DC.

d) Setting items required for PM

Set [Deviation] (peak phase deviation) on the 2nd page of the setting screen.

The output phase changes in the range of \pm peak phase deviation.

If [Source] (modulation source) is set to [Int] (internal), set [ModFctn] (modulation waveform) and [ModFreq] (modulation frequency).

If [Source] (modulation source) is set to [Ext] (external), input the modulation signal to the external modulation/addition input terminal. In the case of ± 1 V input, the prescribed peak frequency deviation results.

4.7.7 Setting PSK

This is binary phase shift modulation by which the output phase is offset according to the modulation signal.

For the manipulation methods that are common with the modulation setting screen, refer to pp. 70 and 72.

a) PSK example

Since the phase changes suddenly, the output signal waveform is non-continuous.

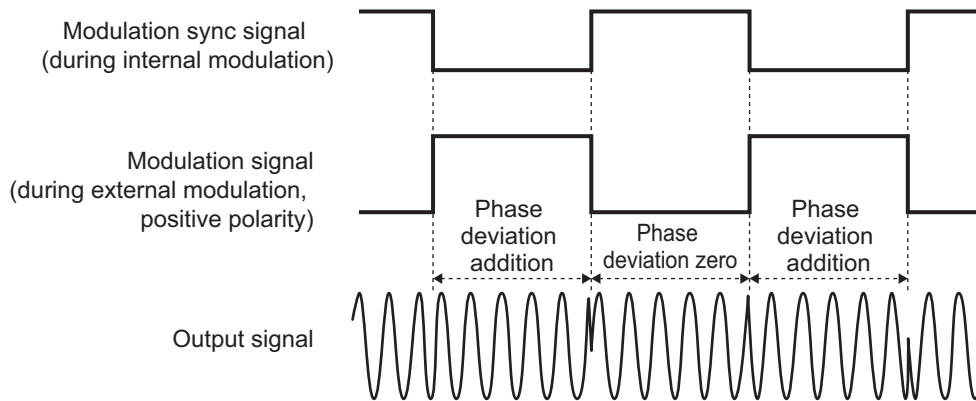

b) Selecting PSK

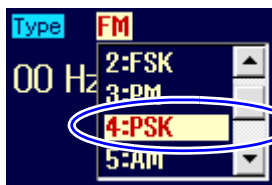

Select [PSK] in [Type] and then press the ENTER key

When [Mode] (oscillation mode) is set to [Modulation], set [Type] (modulation type) on the 2nd page of the setting screen to [PSK] (PSK).

c) Waveforms for which PSK is not possible

PSK is not possible for noise and DC.

d) Setting items required for PSK

Set [Deviation] (phase deviation) on the 2nd page of the setting screen.

The phase deviation zero state and the specified phase deviation state alternate for the output.

Note that the phase does not vary in the \pm phase deviation range.

If [Source] (modulation source) is set to [Int] (internal), set [ModFreq] (modulation frequency).

If [Source] (modulation source) is [Ext] (external), set the trigger polarity and input the modulation signal (TTL level) to the external trigger input terminal. If the polarity is set to [High] (positive), the phase deviation is zero during low-level input, and the specified phase deviation is output during high-level input, and vice versa if the polarity is set to [Low].

4.7.8 Setting AM

The output amplitude changes according to the instantaneous value of the modulation signal.

For the manipulation methods that are common with the modulation setting screen, refer to pp. 70 and 72.

a) AM example

The amplitude of the output signal grows larger when the modulation signal swings to the positive side.

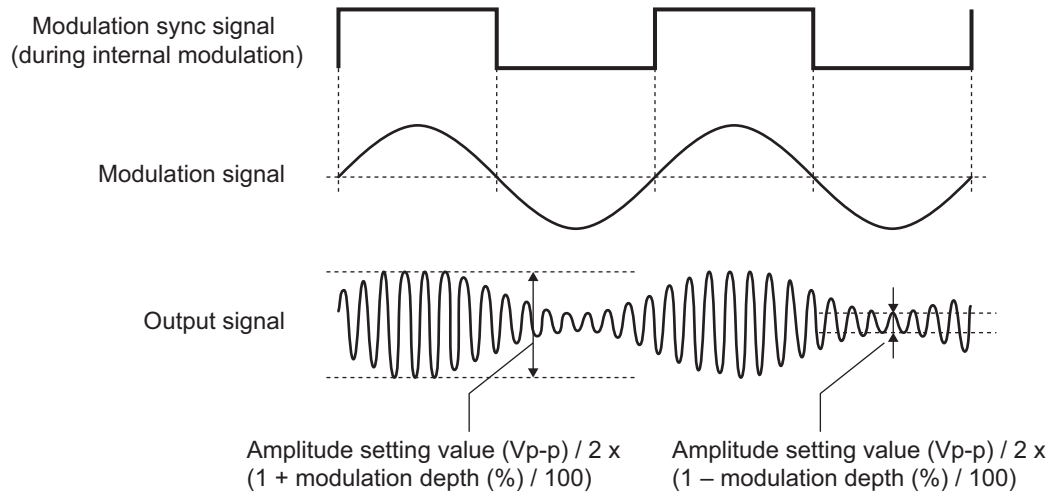

b) Selecting AM

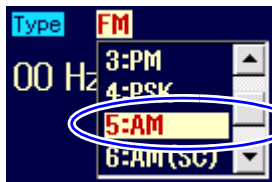

Select [AM] in [Type] and then press the ENTER key

When [Mode] (oscillation mode) is set to [Modulation] (modulation), set [Type] (modulation type) on the 2nd page of the setting screen to [AM] (AM).

c) Waveforms for which AM is not possible

AM is not possible for DC.

d) Setting items required for AM

Set [Amptd] (carrier amplitude) on the 1st page of the setting screen.

Set [Depth] (modulation depth) on the 2nd page of the setting screen.

The output amplitude varies in the range of carrier amplitude setting value $(V_{p-p}) / 2 \times (1 \pm \text{modulation depth} (\%) / 100)$.

When the modulation depth is 0% or the modulation is stopped, the output amplitude is 1/2 of that during continuous oscillation.

When the modulation depth is 100%, the maximum output amplitude envelope value is equal to the carrier amplitude setting value.

If [Source] (modulation source) is set to [Int] (internal), set [ModFctn] (modulation waveform) and [ModFreq] (modulation frequency).

If [Source] (modulation source) is set to [Ext] (external), input the modulation signal to the external modulation/addition input terminal. In the case of ± 1 V input, the prescribed modulation depth results.

4.7.9 Setting AM (DSB-SC)

The output amplitude varies according to the instantaneous value of the modulation signal. This is AM without the carrier frequency component. DSB-SC stands for Double Side Band – Suppressed Carrier.

For the manipulation methods that are common with the modulation setting screen, refer to pp. 70 and 72.

a) AM (DSB-SC) example

When the absolute value of the modulation signal amplitude is large, the amplitude of the output signal is also large. When the value of the modulation signal is negative, the polarity of the output signal is inverted.

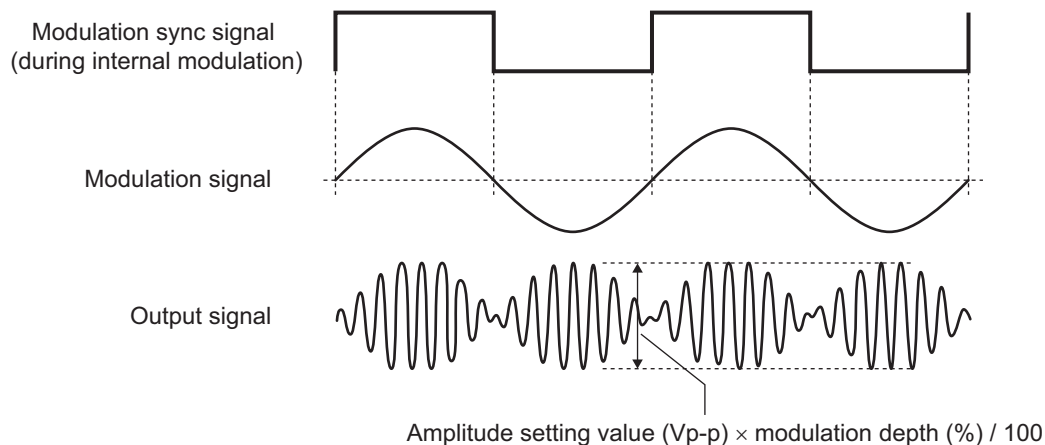

b) Selecting AM (DSB-SC)

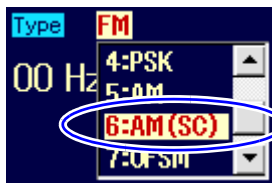

Select [AM(SC)] in [Type] and then press the ENTER key

When [Mode] (oscillation mode) is set to [Modulation] (modulation), set [Type] (modulation type) on the 2nd page of the setting screen to [AM(SC)] (AM (DSB-SC)).

c) Waveforms for which AM (DSB-SC) is not possible

AM (DSB-SC) is not possible for DC.

d) Setting items required for AM (DSB-SC)

Set [Amptd] (carrier amplitude) on the 1st page of the setting screen.

Set [Depth] (modulation depth) on the 2nd page of the setting screen.

The output amplitude varies in the range of carrier amplitude setting value (V_{p-p}) \times modulation depth (%) / 100.

When the modulation depth is 100%, the maximum output amplitude envelope value is equal to the carrier amplitude setting value.

If [Source] (modulation source) is set to [Int] (internal), set [ModFctn] (modulation waveform) and [ModFreq] (modulation frequency).

If [Source] (modulation source) is set to [Ext] (external), input the modulation signal to the external modulation/addition input terminal. In the case of ± 1 V input, the prescribed modulation depth results.

4.7.10 Setting DC offset modulation

DC offset varies according to the instantaneous value of the modulation signal.

For the manipulation methods that are common with the modulation setting screen, refer to pp. 70 and 72.

a) DC offset modulation example

DC offset of the output signal grows larger when the modulation signal swings to the positive side.

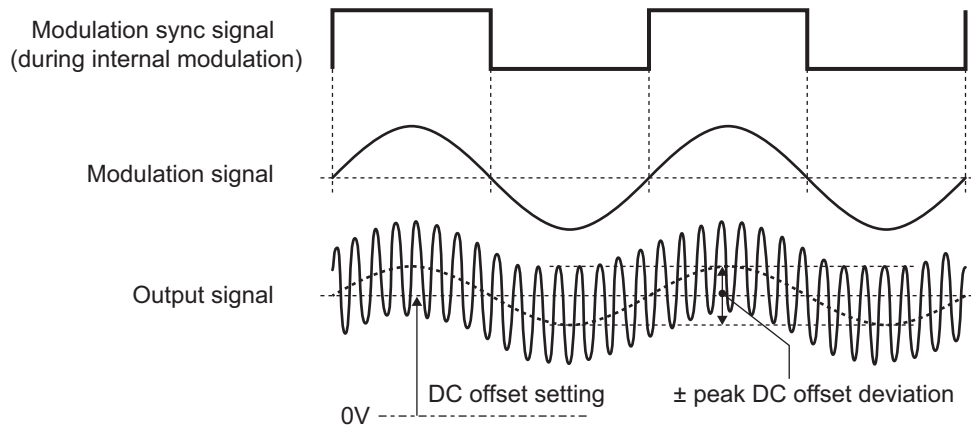

b) Selecting DC offset modulation

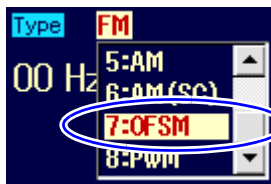

Select [OFSM] in [Type] and then press the ENTER key

When [Mode] (oscillation mode) is set to [Modulation] (modulation), set [Type] (modulation type) on the 2nd page of the setting screen to [OFSM] (DC offset modulation).

c) Waveforms for which DC offset modulation is not possible

None. DC offset modulation is possible for all waveforms.

d) Setting items required for DC offset modulation

Set [Offset] (carrier DC offset) on the 1st page of the setting screen.

Set [Deviation] (peak DC offset deviation) on the 2nd page of the setting screen.

The output DC offset varies in the range of carrier DC offset setting \pm peak DC offset deviation.

If [Source] (modulation source) is set to [Int] (internal), set [ModFctn] (modulation waveform) and [ModFreq] (modulation frequency).

If [Source] (modulation source) is set to [Ext] (external), input the modulation signal to the external modulation/addition input terminal. In the case of ± 1 V input, the prescribed peak DC offset deviation results.

4.7.11 Setting PWM

The duty of square waves and pulse waves varies according to the instantaneous value of the modulation signal.

For the manipulation methods that are common with the modulation setting screen, refer to pp. 70 and 72.

a) PWM example

The duty of the output signal grows larger when the modulation signal swings to the positive side.

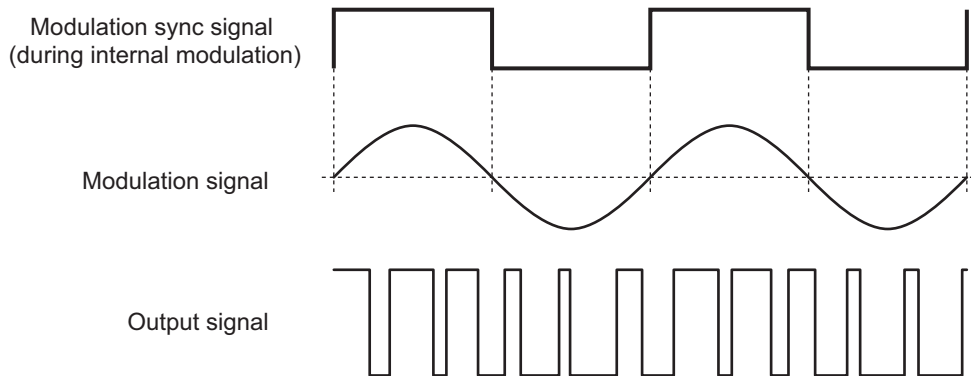

b) Selecting PWM

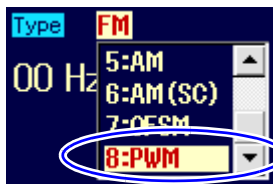

Select [PWM] in [Type] and then press the ENTER key

When [Mode] (modulation mode) is set to [Modulation] (modulation), set [Type] (modulation type) on the 2nd page of the setting screen to [PWM] (PWM).

c) Waveforms for which PWM is not possible

PWM is possible only for square waves and pulse waves.

PWM is not possible for other waveforms.

d) Setting items required for PWM

Set [Duty] (carrier duty) on the 1st page of the setting screen.

Set [Deviation] (peak duty deviation) on the 2nd page of the setting screen.

The output duty varies in the range of carrier duty \pm peak duty deviation.

When the pulse wave is used, the pulse width of the carrier is fixed to the duty setting and cannot be set with time.

If [Source] (modulation source) is set to [Int] (internal), set [ModFctn] (modulation waveform) and [ModFreq] (modulation frequency).

If [Source] (modulation source) is set to [Ext] (external), input the modulation signal to the external modulation/addition input terminal. In the case of ± 1 V input, the prescribed peak duty deviation results.

4.8 Sweep Setting and Manipulation

4.8.1 Sweep types

The following five types of sweep can be done.

- Frequency sweep ☞ p. 95
- Phase sweep ☞ p. 97
- Amplitude sweep ☞ p. 99
- DC offset sweep ☞ p. 101
- Duty sweep ☞ p. 103

4.8.2 Screen for sweep setting and manipulation

This subsection describes the screen configuration used in common for the sweep oscillation mode.

The settings and manipulations are done on the Oscillator setting screen. The Oscillator setting screen is displayed as “Oscillator” in the top left part of the screen. When another screen is displayed, press the **MENU** key to display the top menu, then select [Oscillator] and press the **ENTER** key.

a) Setting the oscillation mode to sweep

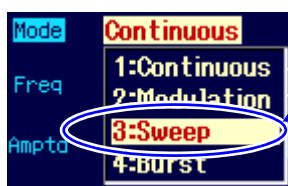

Select [Sweep] in [Mode] and then press the ENTER key

Set [Mode] (oscillation mode) to [Sweep] on the Oscillator setting screen. The oscillation mode is switched to sweep as a result.

In the sweep oscillation mode, the setting screen consists of three pages, which can be switched with the **NEXT** key.

b) 1st page of setting screen: Screen for setting the basic parameters

These are the common setting items that are common to all the oscillation modes. Some of the settings may be invalid depending on the sweep type.

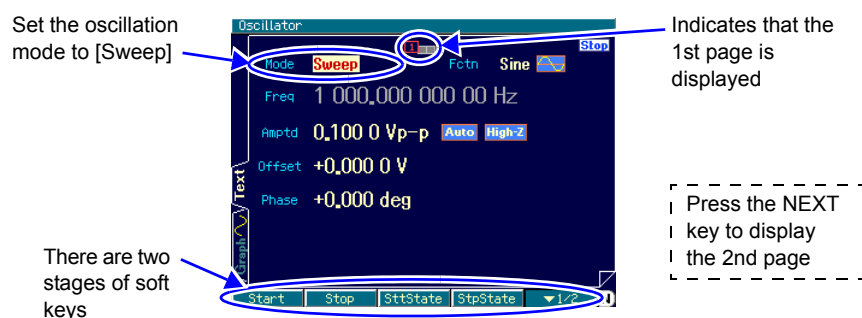

c) 2nd page of setting screen: Screen for the main sweep settings

The figure is an example that shows frequency selection as the sweep type.

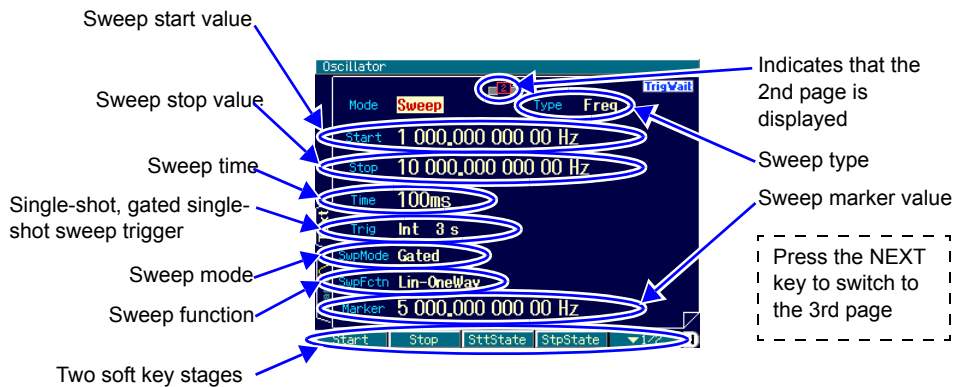

Sweep type [Type]

This is the type of sweep. Frequency, phase, amplitude, DC offset, and duty can be chosen from. ☞ p. 86

Sweep start value [Start]

This is the sweep start value.

Sweep stop value [Stop]

This is the sweep stop value.

Sweep time [Time]

This is the transition time from the start value to the stop value.

Sweep mode [SwpMode]

This is the sweep oscillation mode. Continuous sweep, single-shot sweep, and gated single-shot sweep can be chosen from. ☞ p. 87

Trigger [Trig]

This is the trigger condition for single-shot sweep and gated single-shot sweep. Internal and external can be chosen as the trigger source. ☞ p. 90

Sweep function [SwpFctn]

This is the sweep form. One-way and shuttle can be chosen from. Linear and log are also possible if the sweep type is frequency. ☞ p. 86

Sweep marker value [Marker]

This is the sweep marker value. ☞ p. 92

d) 3rd page of setting screen: Screen for complementary settings for sweep

The figure is an example that shows frequency selection as the sweep type.

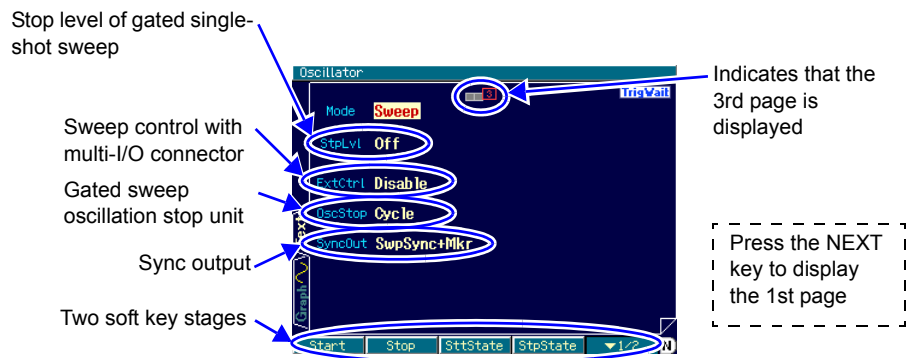

Stop level [StpLvl]

This is the signal level when gated single-shot sweep oscillation is stopped. It can be set either to [Off] or [On] for setting the level. Normally, [Off] is set. ☞ p. 89

External control with multi-I/O connector [ExtCtrl]

Enables/disables external control with the multi-I/O connector. ☞ p. 94

Oscillation stop unit for gated single-shot sweep [OscStop]

This is the oscillation stop unit for gated single-shot sweep. The unit can be selected from 1 cycle and 1/2 cycle. Normally, the unit is set to 1 cycle. ☞ p. 89

Sync output [SyncOut]

This is the output signal from the sync/sub-output terminal. Waveform reference phase sync, sweep sync, sweep marker, and sweep X drive can be selected from. ☞ p. 92

4.8.3 Common sweep settings and manipulations

This subsection describes the settings and manipulations that are used in common regardless of the item to be swept.

a) To set the oscillation mode to sweep → Oscillation mode setting

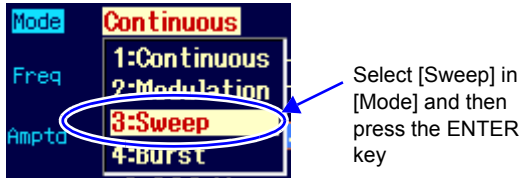

On the Oscillator setting screen, set [Mode] (oscillation mode) to [Sweep]. This changes the mode to the sweep oscillation mode.

In the sweep oscillation mode, the setting screen consists of three pages, which can be switched with the **◀** NEXT key.

b) To select the item to be swept → Sweep type setting

The following five sweep items can be selected in [Type] (sweep type) on the 2nd page of the setting screen.



- Frequency sweep [Freq] ☞ p. 95
- Phase sweep [Phase] ☞ p. 97
- Amplitude sweep [Amptd] ☞ p. 99
- DC offset sweep [Offset] ☞ p. 101
- Duty sweep [Duty] ☞ p. 103

c) To set the sweep range and time

Set the following items on the 2nd page of the setting screen.

- Start value [Start]
- Stop value [Stop]
- Sweep time [Time]: This is the transition time from the start value to the stop value.

For details, refer to the description of each sweep type.

d) To set the sweep range with center and span

When the start value or stop value input field is open on the 2nd page of the setting screen and the current value is displayed, the [Center] or [Span] soft key is displayed. When this key is pressed, the center value or span value input field opens, and the item displays change from [Start] and [Stop] to [Center] and [Span], respectively.

The [Center] or [Span] soft key changes to [Start] or [Stop]. When the [Start] or [Stop] soft key is pressed at this time, the start value or stop value input field is displayed.

The center value is the average of the start value and stop value. The span value is the absolute value of the difference between the start value and the stop value. Even if frequency log sweep is selected, the center value is the linear average of the start value and stop value.

Even when center value and span value display are selected, the relation of magnitude between the start value and stop value is saved.

e) To sweep a sawtooth wave → One-way sweep

Set [SwpFctn] (sweep function) on the 2nd page of the setting screen to [Lin-OneWay]

In the case of frequency sweep, it is also possible to set the slope to [Lin-OneWay] (linear) or [Log-OneWay] (log).

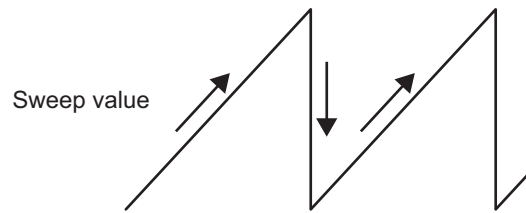
One-way sweep**f) To sweep a triangular wave → Shuttle sweep**

Set [SwpFctn] (sweep function) on the 2nd page of the setting screen to [Lin-Shuttle] (shuttle).

In the case of frequency sweep, it is also possible to set the slope to [Lin-Shuttle] (linear) or [Log-Shuttle] (log).

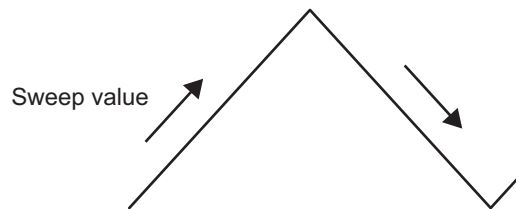
Shuttle sweep**g) To change the rising/falling direction of the sweep → Magnitude relation of start and stop values**

When sweeping is done with a sawtooth wave (one-way sweep), sweeping is done from the start value to the stop value. If start value < stop value, the value increases during sweep execution. Reversely, if start value > stop value, the value decreases during sweep execution.

When the [Stt ⇌ Stp] soft key included in the second stage of the soft key set on the 2nd page of the setting screen ([▼ 2/2] is displayed on the right-most soft key) is pressed, the start value and stop value can be swapped.

h) To continuously repeat sweep → Continuous sweep

Set [SwpMode] (sweep mode) on the 2nd page of the setting screen to [Cont] (continuous).

No trigger signal is required.

The transition time from the start value to the stop value is set with [Time] (sweep time) on the 2nd page.

Since the sweep time is the transition time from the start value to the stop value, when the sweep function is shuttle, the repeat period is twice the length of the sweep time setting, as shown in the following figure.

Continuous one-way sweep

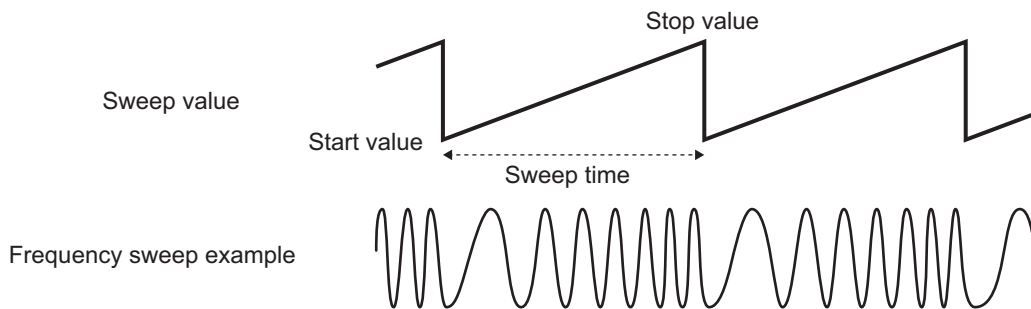

Continuous shuttle sweep

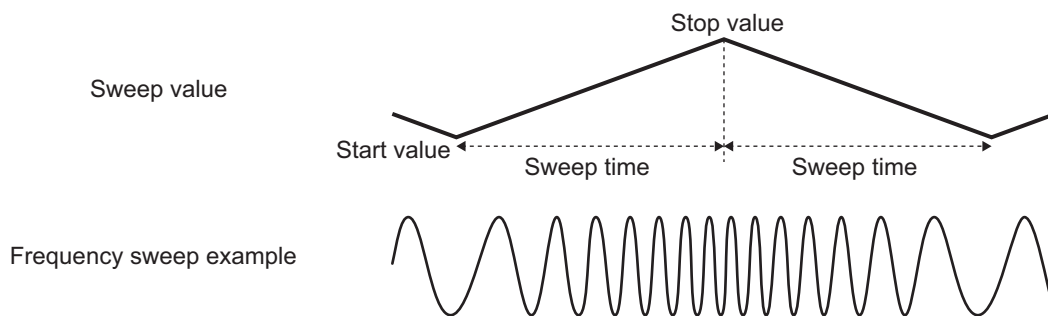

i) To start sweep in synchronization with a trigger → Single-shot sweep

Set [SwpMode] (sweep mode) on the 2nd page of the setting screen to [Single] (single).

Since a trigger signal is required, set the trigger signal with [Trig] (trigger) on the 2nd page. For the trigger setting procedure, see p. 90.

The transition time from the start value to the stop value is set with [Time] (sweep time) on the 2nd page.

In the case of single-shot sweep, one sweep is executed upon reception of a trigger.

The change sequence differs depending on whether the sweep function is one-way or shuttle, as shown in the following figure.

In the case of one-way sweep, the start value is immediately returned to upon sweep completion.

In the case of shuttle sweep, execution enters standby in the sweep completion state.

Single-shot one-way sweep

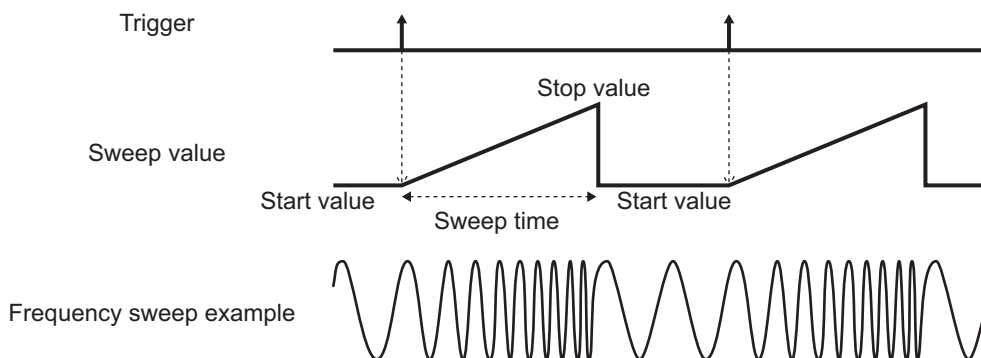

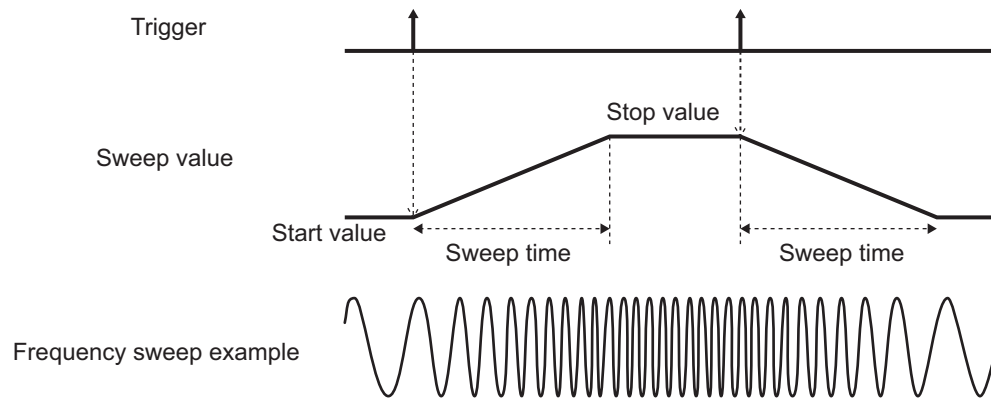
Single-shot shuttle sweep**j) To output the waveform only during sweep execution → Gated single-shot sweep**

Set [SwpMode] (sweep mode) on the 2nd page of the setting screen to [Gated] (gated single-shot). This operation combines gated oscillation and sweep, with sweep execution in synchronization with a trigger.

Since a trigger signal is required, set the trigger signal with [Trig] (trigger) on the 2nd page. For the trigger setting procedure, see p. 90.

■ Oscillation start/stop phase

The oscillation start/stop phase setting is done with [Phase] (phase) on the 1st page of the setting screen.

However, during phase sweep, the start phase setting is the oscillation start phase, and the stop phase setting is the oscillation stop phase.

■ Stop level (normally set to [Off])

To set the level while the oscillation is stopped separately from the phase, set [StpLvl] (stop level) on the 3rd page of the setting screen to [On] (on) and set the level with a % value using the amplitude full scale as reference. Normally, [Off] (off) is set. When [Off] is selected, the signal level while oscillation is stopped is determined by the phase set in [Phase] on the 1st page of the setting screen. For details on the stop level, see p. 112.

■ Oscillation stop unit (normally set to [Cycle] (1 cycle))

To stop oscillation in half-cycle units, set [OscStop] (oscillation stop unit) on the 3rd page of the setting screen to [HalfCycle] (half cycle). Normally, set to [Cycle] (1 cycle). When [Cycle] (1 cycle) is set, whole integer cycle oscillation results.

When oscillation is stopped, it always stops either in 1-cycle or half-cycle units according to the [OscStop] (oscillation stop unit) setting, and the oscillation time is usually longer than the sweep time setting.

Gated single-shot one-way sweep

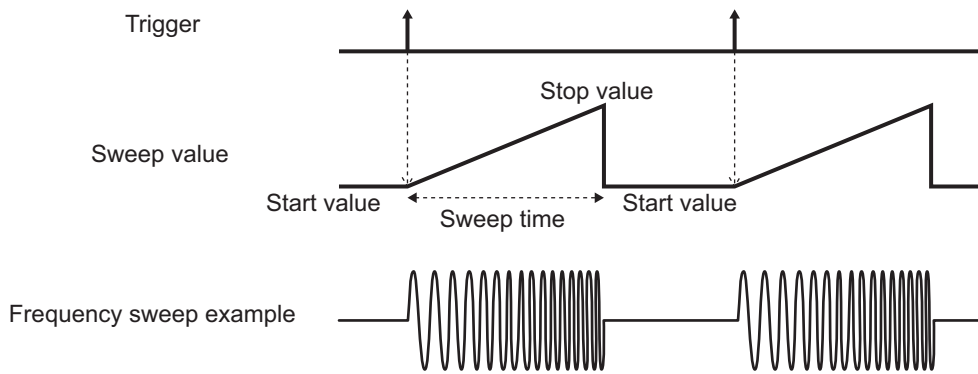

Gated single-shot shuttle sweep

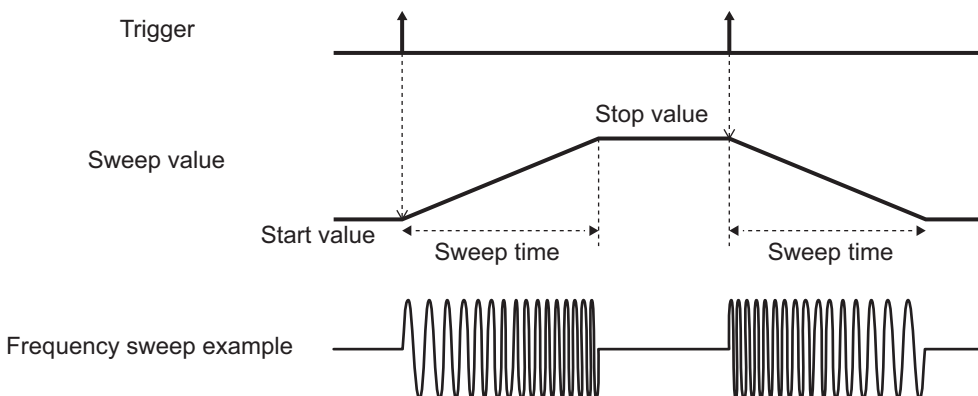

✓ Check

In the case of phase sweep, the start phase setting is the oscillation start phase, and the stop phase setting is the oscillation stop phase.

k) To set trigger condition for single-shot sweep and gated single-shot sweep

The trigger can be selected from internal trigger oscillator, external signal, manual trigger manipulation, and remote trigger manipulation.

Upon receipt of a trigger, the TRIG'D lamp next to the MAN TRIG key lights.

The trigger condition is set with [Trig] (trigger) on the 2nd page of the setting screen.

■ Trigger source setting

The trigger source can be chosen from [Int] (internal) and [Ext] (external).

When the trigger source is [Int] (internal), the trigger period can be set.

When the trigger source is [Ext] (external), the trigger polarity can be set.

If the trigger source is set to [Ext] (external), a TTL level trigger signal is input to the external trigger input terminal (TRIG IN).

Sweeping can be started and stopped independently of the trigger source setting through input of a logic signal to the multi-I/O connector. [☞ p. 94](#)

■ Usage of manual trigger and remote trigger

Manual trigger manipulation and remote trigger manipulation are always effective regardless of the trigger source setting.

The [Start] soft key and the  MAN TRIG key can be used for manual trigger

manipulation.

Note that, in the case of the WF1974, the MAN TRIG key works for the channel whose display is active.

For details on the channel whose display is active, see p. 38.

To use only manual trigger manipulation and remote trigger manipulation as the trigger, set the trigger source to [Ext] (external). Also, to prevent malfunction due to external noise, it is recommended to set the polarity to [Off].

l) To start sweep → [Start] soft key or trigger

When, during continuous sweep, the mode is the sweep oscillation mode, the sweep operation starts automatically.

However, if the sweep setting is improper, sweep oscillation will not start. ([Conflict!] is displayed in the top right part of the screen.) When the [?] soft key appearing at the left end is pressed, a message about the inappropriate setting is displayed. Once the setting has been changed to a suitable setting, sweep oscillation starts.

If sweep operation is currently stopped, press the [Start] soft key to start it. If the [Start] key is not displayed, press the [▼ 2/2] soft key on the right end to switch soft key sets.

In the case of single-shot sweep and gated single-shot sweep, sweeping starts upon receipt of a trigger.

However, if the sweep setting is improper, no trigger can be received ([Conflict!] is displayed in the top right part of the screen). When the [?] soft key appearing at the left end is pressed, a message about the inappropriate setting is displayed. Once the setting has been changed to a suitable setting, trigger reception becomes possible.

The [Start] soft key and the  manual trigger key on the panel operate like manual trigger regardless of the trigger source setting.

m) To stop sweep → [Stop] soft key

When the [Stop] soft key is pressed during sweep execution, the sweep operation stops and the sweep start value output state (and not the stop value output state) is entered. When the [Stop] soft key is not displayed, press the [▼ 2/2] soft key on the right end to switch soft key sets.

However, during single-shot sweep and gated single-shot sweep, sweeping resumes upon receipt of a new trigger.

n) To pause sweep → [Hold] soft key

Press the [Hold] soft key during sweep execution to pause the sweep operation. Then, when the [Resume] soft key is pressed, the sweep operation resumes from where it was paused. If the [Hold] or [Resume] soft key is not displayed, press the [▼ 2/2] soft key on the right end to switch the soft key sets.

However, during hold for single-shot sweep and gated single-shot sweep, sweeping starts from the start upon receipt of a new trigger.

The [Hold] and [Resume] soft keys are displayed in the same location. [Hold] is displayed during sweep execution, and [Resume] is displayed when the sweep operation is paused.

o) To output the sweep start value → [SttState] soft key

Press the [SttState] soft key to set the sweep start value output state.

The status of the equipment under test at the sweep start value can be checked.

The [SttState] soft key is displayed in the sweep start value output state or in the sweep stop value output state. If the [SttState] soft key is not displayed, press the [▼ 2/2] soft key on the right end to switch the soft key sets.

In the case of gated single-shot sweep, the state is the start value oscillation state. To stop oscillation, press the [Stop] soft key.

p) To output the sweep stop value → [StpState] soft key

Press the [StpState] soft key to set the sweep stop value output state.

The status of the equipment under test at the sweep stop value can be checked.

The [StpState] soft key is always displayed in the sweep mode. If the [StpState] soft key is not displayed, press the [▼ 2/2] soft key on the right end to switch the soft key sets.

In the case of gated single-shot sweep, the state is the stop value oscillation state results. To stop the oscillation, press the [Stop] soft key.

q) To output sweep sync signal, sweep marker signal, sweep X drive signal → Sync output setting

This setting is done with [SyncOut] (sync output) on the 3rd page of the setting screen. One of the following four settings can be chosen.

- Signal synchronized with reference phase of the waveform [Sync]
- Signal synchronized with sweep [SwpSync]
- Signal combining marker signal with signal synchronized with sweep [SwpSync+Mkr]
- X drive signal of sweep [X-Drive]

■ When [Sync] is selected

A TTL level signal that rises at the reference phase of the waveform is output from the sync/sub-output terminal.

■ When [SwpSync] is selected

A TTL level signal synchronized with sweep is output from the sync/sub-output terminal. This signal changes from high to low at sweep start.

When the signal being swept is observed with an oscilloscope, it can be used as the trigger signal for the oscilloscope.

■ When [SwpSync+Mkr] is selected

The leading edge of the sweep sync output is used as the marker signal. During the interval from the sweep start value to the marker value, the sweep sync output is low. The sweep sync output does not change over the shuttle sweep course.

It is possible to know the timing at which the signal during sweep execution passes the marker value.

Note that the time width when the sweep sync output is low is limited as follows.

- The time width is limited to about 0.05% to 99.95% of the sweep time. Therefore, when the marker value is close to the start value or the stop value, the time width will not change even if the marker value is changed.
- The resolution of the time width is limited to either 1/32,768 of the sweep time or 8.33 ns, whichever is longer. Therefore, even if the marker value is changed finely, the time width may not always change.

■ When [X-Drive] is selected

A signal of 0 to +3 V/open corresponding to the sweep value is output from the sync/sub-output terminal. The voltage changes linearly proportionally to the elapsed sweep time. Even if [Log-OneWay] or [Log-Shuttle] is selected as the log for the sweep function during frequency sweep, the voltage changes linearly proportionally to the elapsed sweep time.

When the signal during sweep execution is observed with an X-Y display oscilloscope or X-Y recorder, it can be used as the X-axis signal.

The relationships between the sweep values and the various signals are shown in the following figure. When stop value < start value, the slope of the sweep X drive output is the opposite of that in the figure.

Continuous sweep

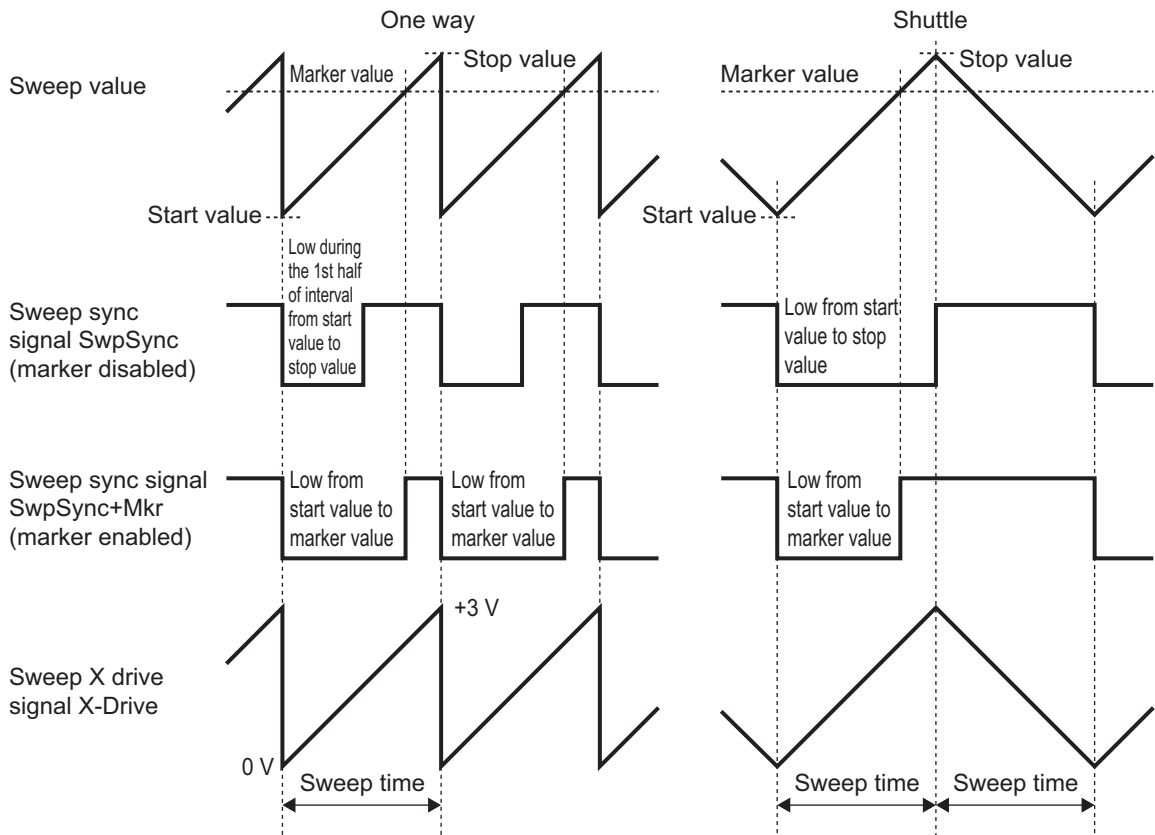

Single-shot sweep, gated single-shot sweep

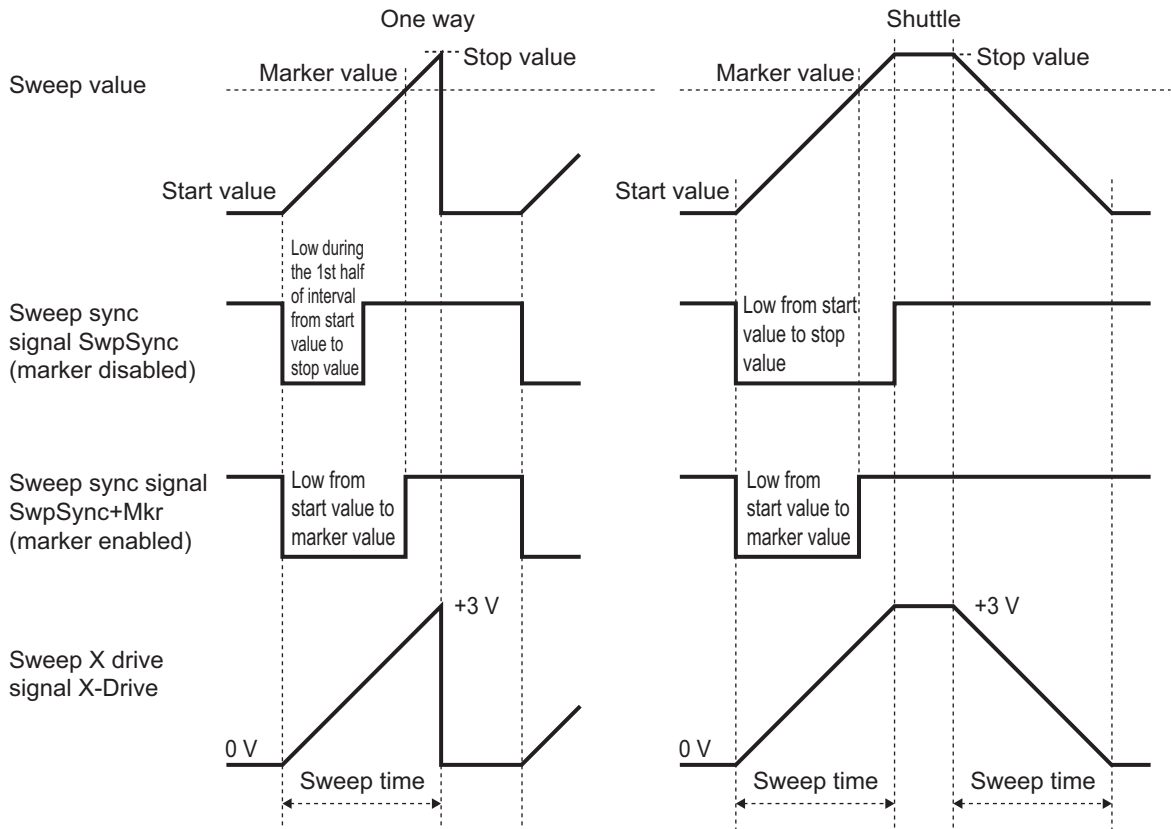

r) To substitute center value to marker value, or substitute marker value to center value

When the [Ctr ⇒ Mkr] soft key on the 2nd page of the setting screen is pressed, the center value is substituted to the marker value. When the [Mkr ⇒ Ctr] soft key is pressed, the marker value is substituted to the center value.

When these soft keys are not displayed on the 2nd page of the setting screen, press the [▼ 1/2] soft key on the right end to switch the soft key sets.

s) To control sweep start, stop, and pause with external logic signal

When [ExtCtrl] (external control) on the 3rd page of the setting screen is set to [Enable], sweep manipulation through TTL level logic input to the multi-I/O connector on the rear panel can be done. This applies in common to CH1 and CH2.

To prevent malfunction due to external noise, it is recommended to set [Disable] (disable) when not using control with an external signal.

For the pin number allocation, see p. 18.

The following manipulations can be done.

■ Sweep start

If sweep operation is currently stopped, the sweep operation starts from the beginning upon input of a falling edge.

During sweep execution, the sweep operation is resumed from the beginning upon input of a falling edge.

During single-shot sweep and gated single-shot sweep, the sweep operation starts from the beginning if a trigger other than this signal is received. ORing with the set trigger source is done.

■ Sweep stop

The sweep operation stops upon input of a falling edge during sweep execution, and the state becomes the sweep start value output state.

However, during single sweep and gated single sweep, the sweep operation starts again from the beginning upon receipt of a new trigger.

■ Sweep hold/resume

The sweep operation is held upon input of a falling edge during sweep execution. The sweep operation resumes from where it was held upon input of a rising edge during hold.

However, during single-shot sweep and gated single-shot sweep, the sweep operation starts again from the beginning upon receipt of a new trigger during hold.

4.8.4 Setting frequency sweep

For the manipulation methods that are common with the sweep setting screen, refer to pp. 83 and 86.

a) Frequency sweep example

The following is an example of continuous, linear shuttle sweep.

Shuttle sweep

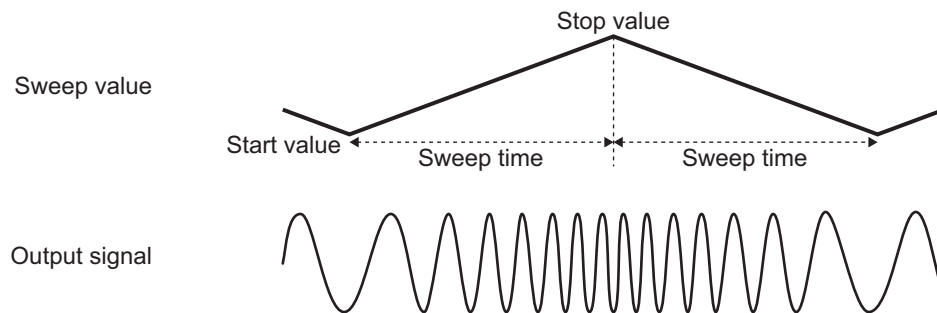

b) Selecting frequency sweep



Select [Freq] in [Type] and then press the ENTER key

When [Mode] (oscillation mode) is set to [Sweep] (sweep), set [Type] (sweep type) on the 2nd page of the setting screen to [Freq] (frequency).

c) Waveforms for which frequency sweep is not possible

Frequency sweep is not possible for noise, pulse wave, and DC.

d) Setting items required for frequency sweep

Set the following items on the 2nd page of the setting screen. The frequency settings on the 1st page of the setting screen are disabled.

- Start frequency [Start]
The frequency range depends on the waveform.
- Stop frequency [Stop]
The frequency range depends on the waveform.
- Sweep time [Time]
This is the transition time from the start frequency to the stop frequency. ☞ p. 87
- Sweep mode [SwpMode]
Continuous, single-shot, and gated single-shot can be chosen from. ☞ p. 87
- Sweep function [SwpFctn]
One-way/shuttle, and linear/log can be chosen from. ☞ p. 86

Setting with [Center] (center frequency) and [Span] (span frequency) instead of the start frequency and stop frequency is also possible. ☞ p. 86

When the sweep mode is single-shot or gated single-shot, [Trig] (trigger condition) must be set. ☞ p. 90

Set the following items as needed.

- Marker frequency [Marker] (2nd page of setting screen) [☞](#) p. 92
- Stop level [StpLvl] (3rd page of setting screen) [☞](#) p. 89
This setting can be used only for gated single-shot sweep.
- External control with multi-I/O connector [ExtCtrl] (3rd page of setting screen) [☞](#) p. 94
- Oscillation stop unit for gated single-shot sweep [OscStop] (3rd page of setting screen) [☞](#) p. 89
This setting can be used only for gated single-shot sweep.
- Sync output [SyncOut] (3rd page of setting screen) [☞](#) p. 92

4.8.5 Setting phase sweep

For the manipulation methods that are common with the sweep setting screen, refer to pp. 83 and 86.

a) Phase sweep example

The following is an example of continuous, linear shuttle sweep.

Shuttle sweep

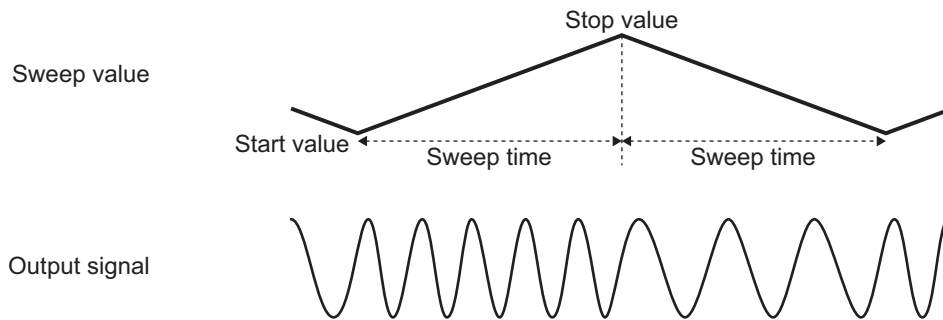

As the phase increases, the frequency rises by the value below, and as the phase decreases, the frequency drops by the value below.

$$\frac{|\text{Stop phase (deg)} - \text{Start phase (deg)}|}{360} \times \frac{1}{\text{Sweep time (s)}}$$

b) Selecting phase sweep

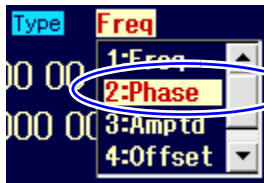

Select [Phase] in [Type] and then press the ENTER key.

When [Mode] (oscillation mode) is set to [Sweep] (sweep), set [Type] (sweep type) on the 2nd page of the setting screen to [Phase] (phase).

c) Waveforms for which phase sweep is not possible

Phase sweep is not possible for noise and DC.

d) Setting items required for phase sweep

Set the following items on the 2nd page of the setting screen. The phase settings on the 1st page of the setting screen are disabled.

- Start phase [Start]
- Stop phase [Stop]
- Sweep time [Time]

This is the transition time from the start phase to the stop phase. ☞ p. 87

- Sweep mode [SwpMode]

Continuous, single-shot, and gated single-shot can be chosen from. ☞ p. 87

- Sweep function [SwpFctn]
One-way/shuttle can be chosen from. ☞ p. 86

Setting with [Center] (center phase) and [Span] (span phase) instead of the start phase and stop phase is also possible. ☞ p. 86

When the sweep mode is single-shot or gated single-shot, [Trig] (trigger condition) must be set. ☞ p. 90

Set the following items as needed.

- Marker phase [Marker] (2nd page of setting screen) ☞ p. 92
- Stop level [StpLvl] (3rd page of setting screen) ☞ p. 89
This setting can be used only for gated single-shot sweep.
- External control with multi-I/O connector [ExtCtrl] (3rd page of setting screen) ☞ p. 94
- Oscillation stop unit for gated single-shot sweep [OscStop] (3rd page of setting screen) ☞ p. 89
This setting can be used only for gated single sweep.
- Sync output [SyncOut] (3rd page of setting screen) ☞ p. 92

4.8.6 Setting amplitude sweep

For the manipulation methods that are common with the sweep setting screen, refer to pp. 83 and 86.

a) Amplitude sweep example

The following is an example of continuous, linear shuttle sweep.

Shuttle sweep

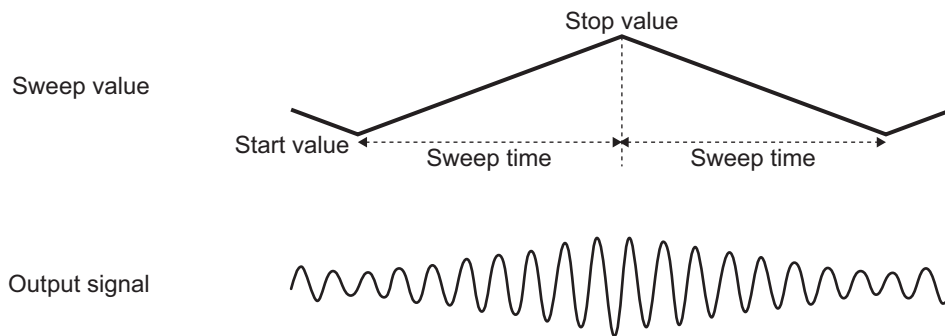

b) Selecting amplitude sweep

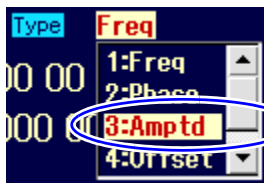

Select [Amptd] in [Type] and then press the ENTER key

When [Mode] (oscillation mode) is set to [Sweep] (sweep), set [Type] (sweep type) on the 2nd page of the setting screen to [Amptd] (amplitude).

c) Waveforms for which amplitude sweep is not possible

Amplitude sweep is not possible for DC.

d) Setting items required for amplitude sweep

Set the following items on the 2nd page of the setting screen. The amplitude settings on the 1st page of the setting screen are disabled.

- Start amplitude [Start]
- Stop amplitude [Stop]
- Sweep time [Time]
 - This is the transition time from the start amplitude to the stop amplitude. ☞ p. 87
- Sweep mode [SwpMode]
 - Continuous, single-shot, and gated single-shot can be chosen from. ☞ p. 87
- Sweep function [SwpFctn]
 - One-way/shuttle can be chosen from. ☞ p. 86

Setting with [Center] (center amplitude) and [Span] (span amplitude) instead of the start amplitude and stop amplitude is also possible. ☞ p. 86

When the sweep mode is single-shot or gated single-shot, [Trig] (trigger condition) must be set. ☞ p. 90

Set the following items as needed.

- Marker amplitude [Marker] (2nd page of setting screen) ☞ p. 92
- Stop level [StpLvl] (3rd page of setting screen) ☞ p. 89
This setting can be used only for gated single-shot sweep.
- External control with multi-I/O connector [ExtCtrl] (3rd page of setting screen) ☞ p. 94
- Oscillation stop unit for gated single sweep [OscStop] (3rd page of setting screen) ☞ p. 89
This setting can be used only for gated single-shot sweep.
- Sync output [SyncOut] (3rd page of setting screen) ☞ p. 92

4.8.7 Setting DC offset sweep

For the manipulation methods that are common with the sweep setting screen, refer to pp. 83 and 86.

a) DC offset sweep example

The following is an example of continuous, linear shuttle sweep.

Shuttle sweep

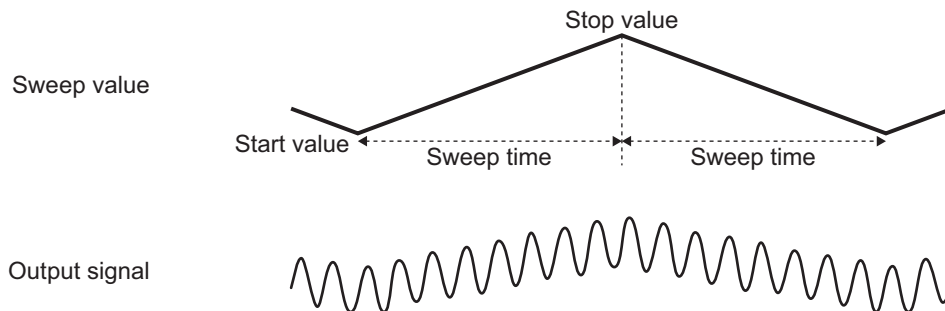

b) Selecting DC offset sweep

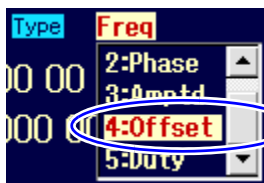

Select [Offset] in [Type] and then press the ENTER key.

When [Mode] (oscillation mode) is set to [Sweep] (sweep), set [Type] (sweep type) on the 2nd page of the setting screen to [Offset] (DC offset).

c) Waveforms for which DC offset sweep is not possible

None. DC offset sweep is possible for all waveforms. However, when DC is selected as the waveform, the DC level itself becomes the sweep object. Moreover, when DC is selected as the waveform, gated single-shot sweep cannot be done.

d) Setting items required for DC offset sweep

Set the following items on the 2nd page of the setting screen. The DC offset settings on the 1st page of the setting screen are invalid.

- Start DC offset [Start]
- Stop DC offset [Stop]
- Sweep time [Time]
 - This is the transition time from start DC offset to stop DC offset. ☞ p. 87
- Sweep mode [SwpMode]
 - Continuous, single-shot, and gated single-shot can be chosen from. ☞ p. 87
- Sweep function [SwpFctn]
 - One-way/shuttle can be chosen from. ☞ p. 86

Setting with [Center] (center DC offset) and [Span] (span DC offset) instead of start DC offset and stop DC offset is also possible. ☞ p. 86

When the sweep mode is single-shot or gated single-shot, [Trig] (trigger condition) must be set. ☞ p. 90

Set the following items as needed.

- Marker DC offset [Marker] (2nd page of setting screen) [☞](#) p. 92
- Stop level [StpLvl] (3rd page of setting screen) [☞](#) p. 89
This setting can be used only for gated single-shot sweep.
- External control with multi-I/O connector [ExtCtrl] (3rd page of setting screen) [☞](#) p. 94
- Oscillation stop unit for gated single sweep [OscStop] (3rd page of setting screen) [☞](#) p. 89
This setting can be used only for gated single-shot sweep.
- Sync output [SyncOut] (3rd page of setting screen) [☞](#) p. 92

4.8.8 Setting duty sweep

For the manipulation methods that are common with the sweep setting screen, refer to pp. 83 and 86.

a) Duty sweep example

The following is an example of continuous, linear shuttle sweep.

Shuttle sweep

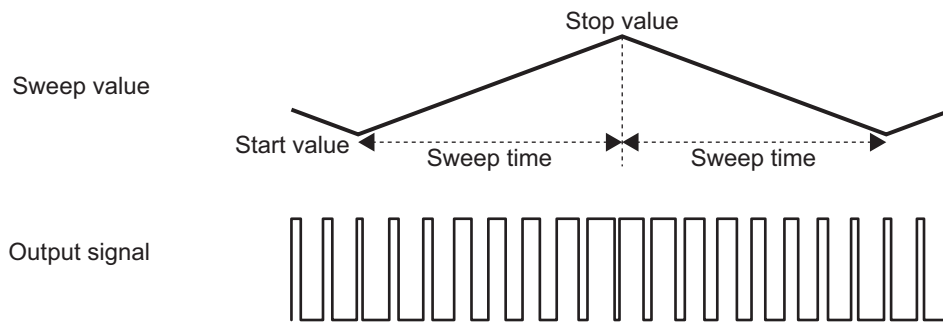

b) Selecting duty sweep

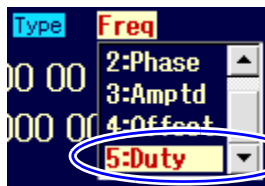

Select [Duty] in [Type] and then press the ENTER key.

When [Mode] (oscillation mode) is set to [Sweep] (sweep), set [Type] (sweep type) on the 2nd page of the setting screen to [Duty] (duty).

c) Waveforms for which duty sweep is not possible

Duty sweep is possible only for square and pulse waves.

d) Setting items required for duty sweep

Set the following items on the 2nd page of the setting screen. The duty settings on the 1st page of the setting screen are disabled.

- Start duty [Start]

The duty range depends on the frequency. In the case of a pulse wave, it also depends on the leading edge time and the trailing edge time. ☞ pp. 60, 63
- Stop duty [Stop]

The duty range depends on the frequency. In the case of a pulse wave, it also depends on the leading edge time and the trailing edge time. ☞ pp. 60, 63
- Sweep time [Time]

This is the transition time from the start duty to the stop duty. ☞ p. 87
- Sweep mode [SwpMode]

Continuous, single-shot, and gated single-shot can be chosen from. ☞ p. 87
- Sweep function [SwpFctn]

One-way/shuttle can be chosen from. ☞ p. 86

Setting with [Center] (center duty) and [Span] (span duty) instead of the start duty and stop duty is also possible. ☞ p. 86

When the sweep mode is single-shot or gated single-shot, [Trig] (trigger condition) must be set. [☞ p. 90](#)

Set the following items as needed.

- Marker duty [Marker] (2nd page of setting screen) [☞ p. 92](#)
- Stop level [StpLvl] (3rd page of setting screen) [☞ p. 89](#)
This setting can be used only for gated single-shot sweep.
- External control with multi-I/O connector [ExtCtrl] (3rd page of setting screen) [☞ p. 94](#)
- Oscillation stop unit for gated single-shot sweep [OscStop] (3rd page of setting screen) [☞ p. 89](#)
This setting can be used only for gated single-shot sweep.
- Sync output [SyncOut] (3rd page of setting screen) [☞ p. 92](#)

4.9 Burst Setting and Manipulation

4.9.1 Burst oscillation types

The following four types of burst oscillation can be done.

- Auto burst
Oscillation and stop are automatically repeated with the respectively specified wave number. No trigger signal is required. ☞ p. 106
- Trigger burst
Oscillation with the specified wave number is done each time a trigger is received.
☞ p. 109
- Gate oscillation
Oscillation is done in integer cycles or half cycles while the gate is on. ☞ p. 113
- Triggered gate oscillation
This is gate oscillation that switches the gate on/off each time a trigger is received.
☞ p. 118

4.9.2 Auto burst

Oscillation and stop are automatically repeated with the respectively specified wave number. No trigger signal is required.

Settings and manipulations are done on the Oscillator setting screen. "Oscillator" is displayed at the top left of the Oscillator setting screen. When another screen is displayed, pressing the **MENU** MENU key displays the top menu, so select [Oscillator] and then press the **ENTER** ENTER key.

a) Auto burst example

The following example is for mark wave number (oscillation wave number) = 3, space wave number (oscillation stop wave number) = 2, oscillation start/stop phase = 30°, stop level = off.

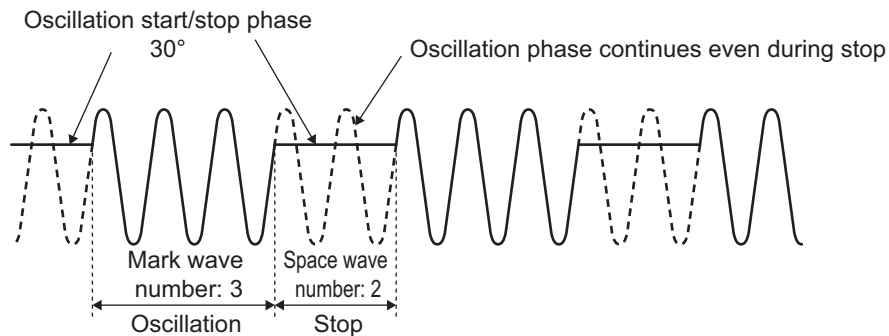

b) Setting the oscillation mode to auto burst

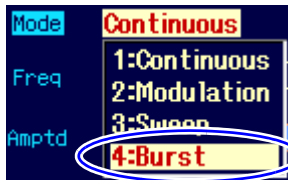

Select [Burst] in [Mode] and then press the ENTER key

Set [Mode] (oscillation mode) to [Burst] on the Oscillator setting screen. The oscillation mode is switched to the burst oscillation mode as a result.

In the burst oscillation mode, the setting screen consists of two pages, which can be toggled with the **NEXT** NEXT key.

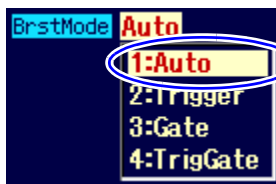

Select [Auto] in [BrstMode] and then press the ENTER key

Next, set [BrstMode] (burst mode) to [Auto] (auto) on the 2nd page of the burst oscillation mode.

c) Auto burst setting screen

■ 1st page: Screen for the basic parameters

These are the common setting items that are common to all the oscillation modes.

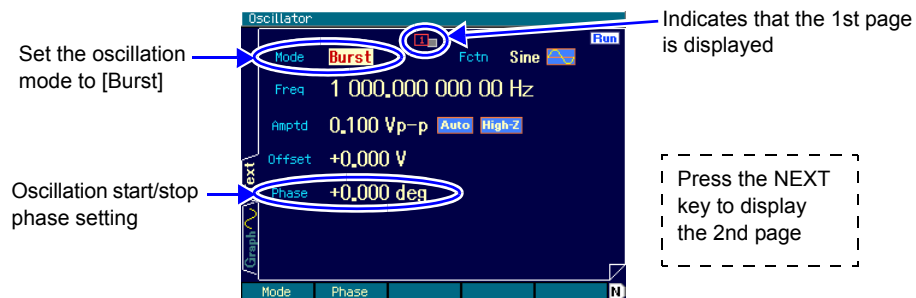

Oscillation start/stop phase [Phase]

This is the phase at which oscillation starts and stops.

■ 2nd page: Screen for the auto burst settings

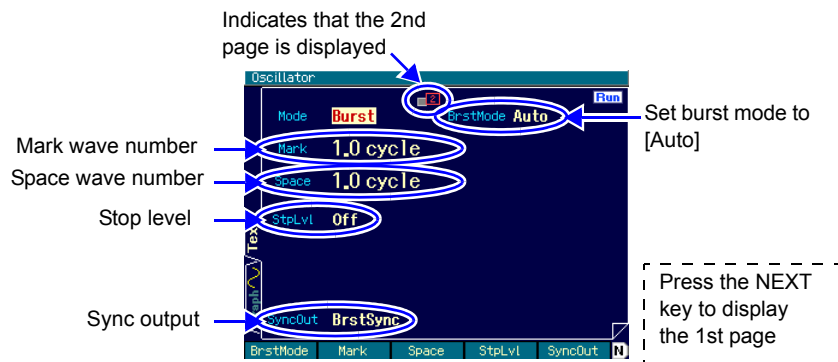

Mark wave number [Mark]

This is the wave number for oscillation. It can be set in 0.5-cycle units. Normally, it is set in 1-cycle units.

Space wave number [Space]

This is the wave number for oscillation stop. It can be set in 0.5-cycle units. Normally, it is set in 1-cycle units.

Stop level [StpLvl]

This is the signal level during oscillation stop. The level can be set to either off or on. Normally, it is set to off. ☞ p. 108

Sync output [SyncOut]

This is the output signal from the sync/sub-output terminal. Waveform reference phase synchronization and burst synchronization can be chosen from. ☞ p. 108

d) Waveforms for which auto burst is not possible

Auto burst is not possible for noise and DC.

e) Setting items required for auto burst

Set [Phase] (oscillation start/stop phase) on the 1st page of the setting screen.

Set [Mark] (mark wave number) and [Space] (space wave number) on the 2nd page of the setting screen.

Each wave number is normally set to an integer value.

[StpLvl] (stop level) on the 2nd page of the setting screen is normally set to [Off] (off). ☞ p. 108

f) To start auto burst → Automatically starts

When, in the auto burst mode, the mode is set to the burst oscillation mode, burst starts automatically.

However, if the burst setting is improper, burst oscillation will not start. ([Conflict!] is displayed in the top right part of the screen.) When the [?] soft key appearing at the left end is pressed, a message about the inappropriate setting is displayed. Once the setting has been changed to an appropriate setting, burst oscillation starts.

g) Stopping auto burst → Not possible

Oscillation cannot be stopped in the auto burst mode as is.

To stop oscillation, set [BrstMode] (burst mode) on the 2nd page of the setting screen to a setting other than [Auto] (auto), and then set so that no trigger or gate signal is input. ☞ p. 111

To set continuous oscillation, change [Mode] (oscillation mode) to [Continuous].

h) To output burst sync signal: Sync output setting

Set burst sync signal with [SyncOut] (sync output) on the 2nd page of the setting screen. One of the following two settings can be selected.

- Signal synchronized with the reference phase of the waveform [Sync]
- Signal synchronized with burst oscillation [BrstSync]

■ When [Sync] is selected

A TTL level signal that rises at the reference phase of the waveform is output from the sync/sub-output terminal.

■ When [BrstSync] is selected

A TTL level signal synchronized with the burst oscillation is output from the sync/sub-output terminal. As shown in the following figure, this signal is low during oscillation and high during oscillation stop.

When the signal during burst is observed with an oscilloscope, it can be used as the trigger signal for the oscilloscope.

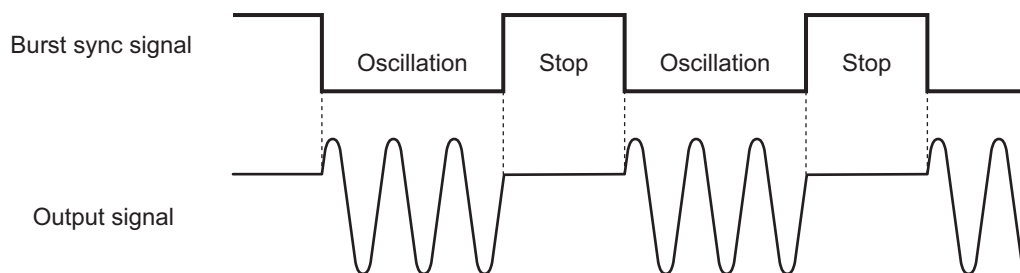
**i) Usage of stop level**

The level when oscillation is stopped is normally set with the oscillation start/stop phase, but it can also be set independently from that with a proportion of the amplitude full scale.

Set [StpLvl] (stop level) on the 2nd page of the setting screen to [On] and set the level with a % value. ☞ p. 112

4.9.3 Trigger burst

Oscillation with the specified wave number is done each time a trigger is received. Settings and manipulations are done on the Oscillator setting screen. "Oscillator" is displayed at the top left of the oscillator setting screen. When another screen is displayed, pressing the **MENU** MENU key displays the top menu, so select [Oscillator] and then press the **ENTER** ENTER key.

a) Trigger burst example

The following example is for mark wave number (oscillation wave number) = 4, oscillation start/stop phase = 30°, stop level = off.

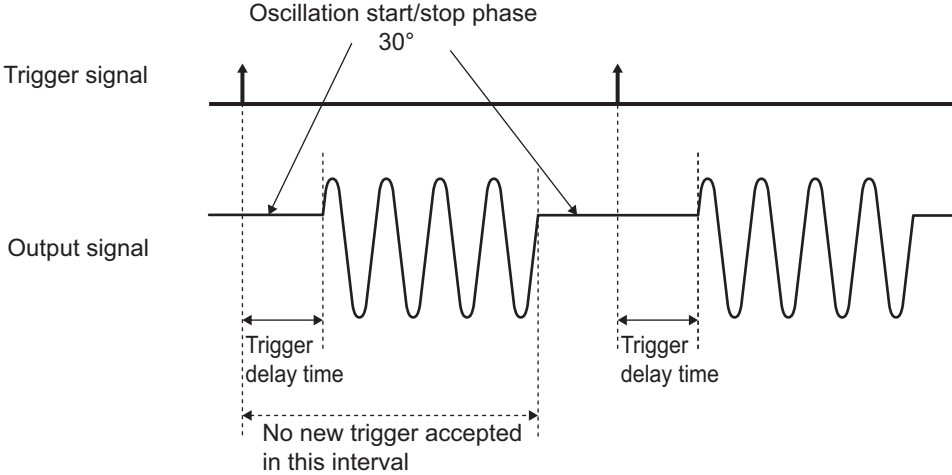

b) Setting the oscillation mode to trigger burst

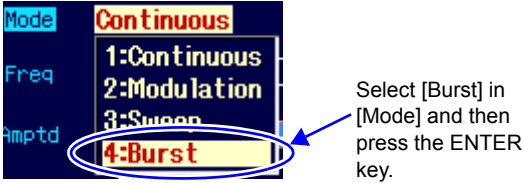

Set [Mode] (oscillation mode) to [Burst] on the Oscillator setting screen. The oscillation mode is switched to the burst oscillation mode as a result. In the burst oscillation mode, the setting screen consists of two pages, which can be toggled with the **NEXT** NEXT key.

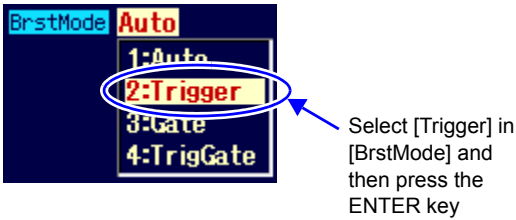

Next, set [BrstMode] (burst mode) on the 2nd page of the burst oscillation mode setting screen to [Trigger] (trigger burst).

c) Trigger burst setting screen

■ 1st page: Screen for the basic parameters

These are the common setting items that are common to all the oscillation modes.

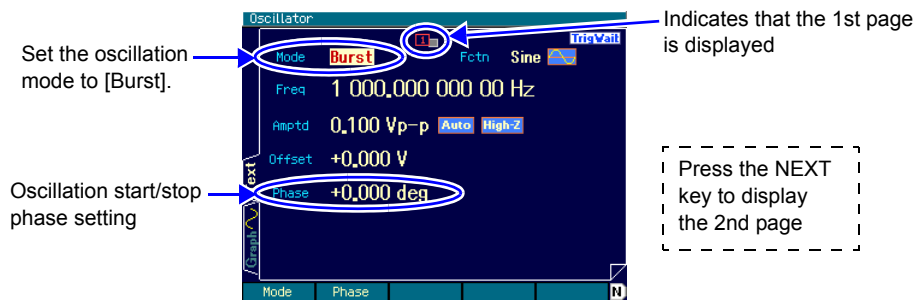

Oscillation start/stop phase [Phase]

This is the phase at which oscillation starts and stops.

■ 2nd page: Screen for the trigger burst settings

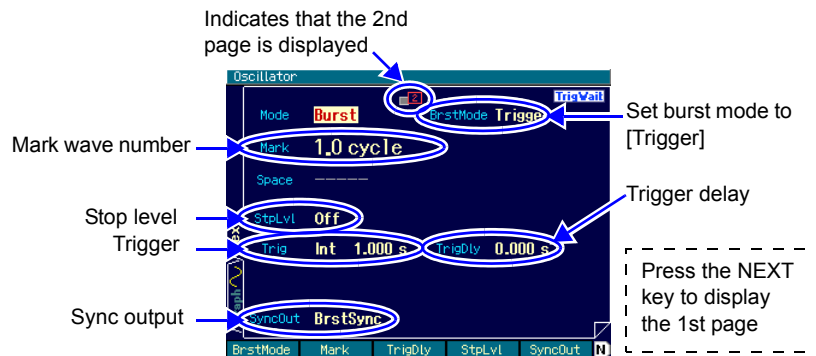

Mark wave number [Mark]

This is the wave number for oscillation each time a trigger is received. It can be set in 0.5-cycle units.

Stop level [StpLvl]

This is the signal level during oscillation stop. The level can be set to either off or on. Normally, it is set to off. ☞ p. 112

Trigger [Trig]

This is the trigger condition. Internal and external can be chosen as the trigger source. ☞ p. 111

Trigger delay [TrigDly]

This is the trigger delay time. Upon receipt of a trigger, oscillation starts following the lapse of the specified time. ☞ p. 111

Sync out [SyncOut]

This is the output signal from the sync/sub-output terminal. Waveform reference phase synchronization and burst synchronization can be chosen from. ☞ p. 111

d) Waveforms for which trigger burst is not possible

Trigger burst is not possible for noise and DC.

e) Setting items required for trigger burst

On the 1st page of the setting screen, set [Phase] (oscillation start/stop phase).

On the 2nd page of the setting screen, set [Mark] (mark wave number). Normally, the wave

number is set to an integer value.

[StpLvl] (stop level) on the 2nd page of the setting screen is normally set to [Off] (off).  p. 112
A trigger is required for trigger burst. Refer to the following item.

f) Trigger settings for trigger burst

The trigger can be selected from internal trigger oscillator, external signal, manual trigger key manipulation, and remote trigger manipulation.

Upon receipt of a trigger, the TRIG'D lamp next to the MAN TRIG key lights.

The trigger source is set with [Trig] (trigger) on the 2nd page of the setting screen.

■ Trigger source setting

The trigger source can be chosen from [Int] (internal) and [Ext] (external).

When the trigger source is [Int] (internal), the trigger period can be set.

When the trigger source is [Ext] (external), the trigger polarity can be set.

If the trigger source is set to [Ext] (external), a TTL level trigger signal is input to the external trigger input terminal (TRIG IN).

■ Usage of manual trigger and remote trigger

Manual trigger manipulation and remote trigger manipulation are always effective regardless of the trigger source setting.

The  MAN TRIG key can be used for manual trigger manipulation.

Note that, in the case of the WF1974, the MAN TRIG key works for the channel whose display is active.

For details on the channel whose display is active,  p. 38.

To use only manual trigger manipulation and remote trigger manipulation as the trigger, set the trigger source to [Ext] (external). Also, to prevent malfunction due to external noise at this time, it is recommended to set the polarity to [Off].

■ Trigger delay setting

Set the trigger delay time with [TrigDly] (trigger delay) on the 2nd page of the setting screen. Upon receipt of a trigger, oscillation starts following the lapse of the specified time. The trigger delay time setting is valid both for internal and external. Set the trigger delay time for the internal trigger source to 0. The trigger delay time setting is invalid for a manual trigger and a remote trigger.

When the trigger delay time setting is zero, the delay within the unit is minimal, but the waveform that is actually output contains a delay.  p. 140

Following receipt of a trigger, no new trigger is accepted until the oscillation of the specified mark wave number has been completed.

g) To start trigger burst → Trigger

Upon receipt of a trigger, oscillation of the specified wave number is performed.

The trigger can be selected from internal trigger oscillator, external signal, manual trigger manipulation, and remote trigger manipulation.

h) To output burst sync signal → Sync output setting

This setting is done with [SyncOut] (sync output) on the 2nd page of the setting screen. One of the following two settings can be selected.

- Signal synchronized with the reference phase of the waveform [Sync]
- Signal synchronized with burst oscillation [BrstSync]

■ **When [Sync] is selected**

A TTL level signal that rises at the reference phase of the waveform is output from the sync/sub-output terminal.

■ **When [BrstSync] is selected**

A TTL level signal synchronized with the burst oscillation is output from the sync/sub-output terminal. As shown in the following figure, this signal is low during oscillation and high during oscillation stop.

When the signal during burst is observed with an oscilloscope, it can be used as the trigger signal for the oscilloscope.

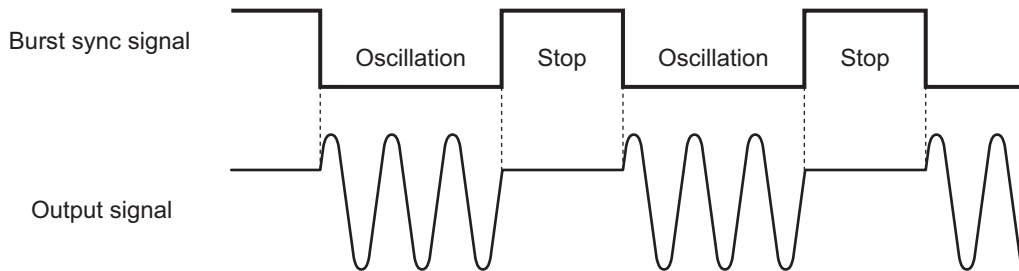

i) Usage of stop level

The level when oscillation is stopped is normally set with the oscillation start/stop phase, but it can also be set independently from that with a proportion of the amplitude full scale.

Set [StpLvl] (stop level) on the 2nd page of the setting screen to [On] (on) and set the level with a % value.

The following examples are for mark wave number = 3, oscillation start/stop phase = 30°, stop level = off, and -50% when on. Note that the oscillation start/stop phase remains valid.

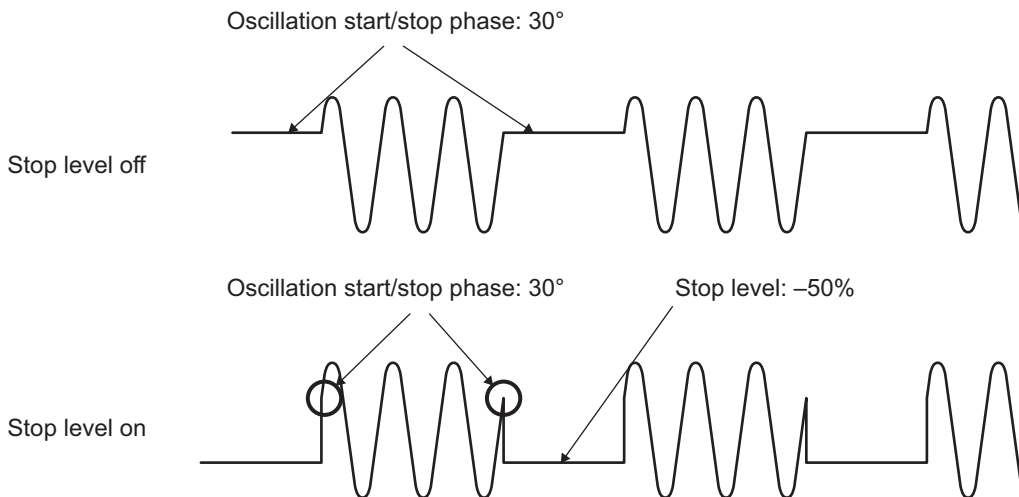

When the stop level is applied to a square waveform, a 3-value square waveform can be output, as shown in the following figure. In the example presented in this figure, the stop level is set to 0%, and the oscillation start/stop phase to 0°. (Either the normal or extended variable duty range may be used.) If the stop level is not applied, the level of the square waveform during oscillation stop is either to low level or high level.

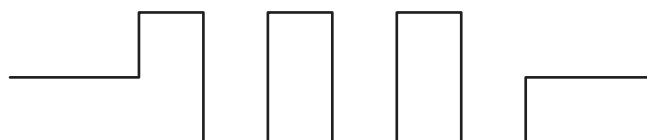

4.9.4 Gate oscillation

Oscillation is done in integer cycles or half cycles while the gate is on.

The settings and manipulations are done on the Oscillator setting screen. "Oscillator" is displayed at the top left of the Oscillator setting screen. When another screen is displayed, pressing the **MENU** MENU key displays the top menu, so select [Oscillator] and then press the **ENTER** ENTER key.

a) Gate oscillation example

The following example is for oscillation start/stop phase = 30°, oscillation stop unit = 1 cycle, stop level = off.

After the gate signal becomes off, oscillation stops once the oscillation start/stop phase is reached.

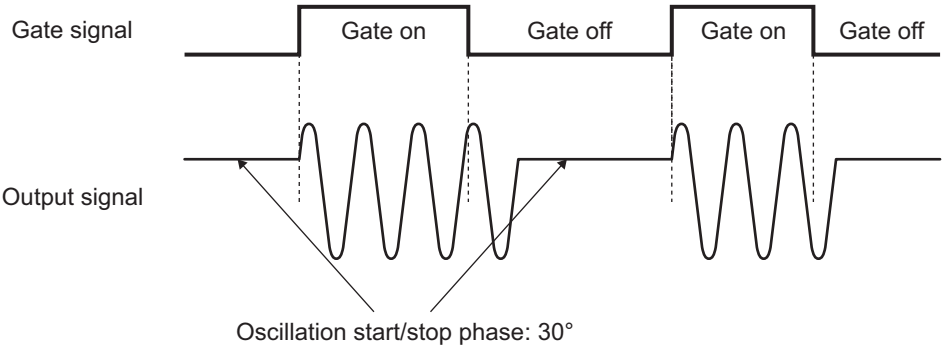

b) Setting the oscillation mode to gate oscillation

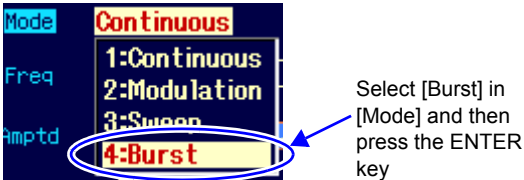

Set [Mode] (oscillation mode) to [Burst] (burst) on the Oscillator setting screen. The oscillation mode is switched to the burst oscillation mode as a result. In the burst oscillation mode, the setting screen consists of two pages, which can be toggled with the **NEXT** NEXT key.



Next, set [BrstMode] (burst mode) on the 2nd page of the burst oscillation mode setting screen to [Gate] (gate oscillation).

c) Gate oscillation setting screen

■ 1st page: Screen for the basic parameters

These are the common setting items that are common to all the oscillation modes.

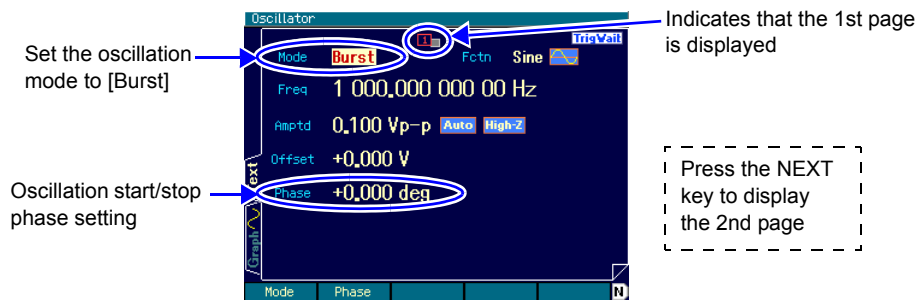

Oscillation start/stop phase [Phase]

This is the phase at which oscillation starts and stops.

■ 2nd page: Screen for the gate oscillation settings

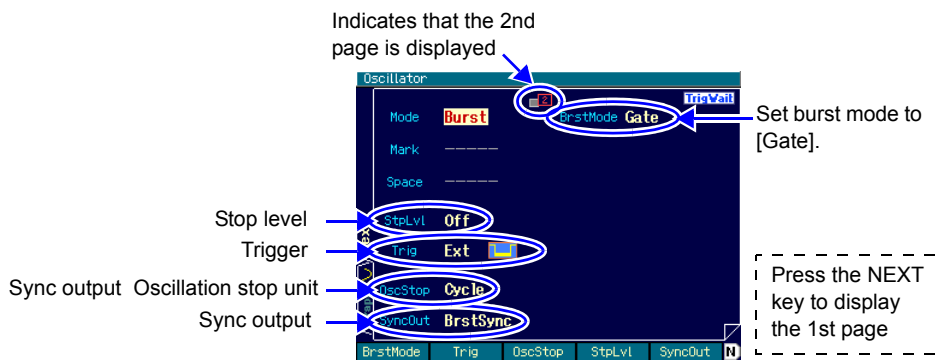

Stop level [StpLvl]

This is the signal level during oscillation stop. The level can be set to either off or on. Normally, it is set to off. ☞ p. 116

Trigger [Trig]

This is the trigger condition (gate condition). Internal and external can be chosen as the trigger source. ☞ p. 115

Oscillation stop unit [OscStop]

This is the oscillation stop unit. One cycle and 0.5 cycles can be chosen from. Normally, 1 cycle is set. ☞ p. 116

Sync output [SyncOut]

This is the output signal from the sync/sub-output terminal. Waveform reference phase synchronization and burst synchronization can be chosen from. ☞ p. 115

d) Waveforms for which auto burst is not possible

Gate oscillation is not possible for DC.

Gate oscillation can be done for noise, but the operation differs from that of other waveforms. ☞ p. 117

e) Setting items required for gate oscillation

On the 1st page of the setting screen, set [Phase] (oscillation start/stop phase).

Normally, set [StpLvl] (stop level) on the 2nd page of the setting screen to [Off]. ☞ p. 116

Set [OscStop] (oscillation stop unit) on the 2nd page of the setting screen to [Cycle] (1 cycle)

normally.  p. 116

A trigger (gate) is required for gate oscillation. Refer to the following item.

f) Trigger (gate) settings for gate oscillation

The trigger (gate) can be selected from internal trigger oscillator, external signal, manual trigger key manipulation, and remote trigger manipulation.

While the gate signal is on, the TRIG'D lamp next to the MAN TRIG key lights.

The trigger source is set with [Trig] (trigger) on the 2nd page of the setting screen. The trigger delay is fixed to minimum.

■ Trigger source setting

The trigger source can be chosen from [Int] (internal) and [Ext] (external).

When the trigger source is [Int] (internal), the trigger period can be set. At this time, the gate signal is a square wave with 50% duty.

When the trigger source is [Ext] (external), the trigger polarity can be set.

If the trigger source is set to [Ext] (external), a TTL level trigger signal is input to the external trigger input terminal (TRIG IN).

■ Usage of manual trigger and remote trigger

Manual trigger manipulation and remote trigger manipulation are always valid regardless of the trigger source setting.

The  MAN TRIG key can be used for manual trigger manipulation.

The gate signal is on while the MAN TRIG key is pressed. However, in the case of the WF1974, the MAN TRIG key works for the channel whose display is active.

For details on the channel whose display is active,  p. 38.

To use only manual trigger manipulation and remote trigger manipulation as the trigger, set the trigger source to [Ext] (external). Also, to prevent malfunction due to external noise at this time, it is recommended to set the polarity to [Off].

g) To start gate oscillation → Trigger (gate signal)

Oscillation is executed upon reception of gate signal on.

The trigger can be selected from internal trigger oscillator, external signal, manual trigger manipulation, and remote trigger manipulation.

h) To output the burst sync signal → Sync output setting

This setting is done with [SyncOut] (sync output) on the 2nd page of the setting screen. One of the following two settings can be selected.

- Signal synchronized with the reference phase of the waveform [Sync]
- Signal synchronized with burst oscillation [BrstSync]

■ When [Sync] is selected

A TTL level signal that rises at the reference phase of the waveform is output from the sync/sub-output terminal.

■ When [BrstSync] is selected

A TTL level signal synchronized with the gate oscillation is output from the sync/sub-output terminal. As shown in the following figure, this signal is low during oscillation and high during oscillation stop. Note that this differs from the gate signal.

When the signal during burst is observed with an oscilloscope, it can be used as the trigger signal for the oscilloscope.

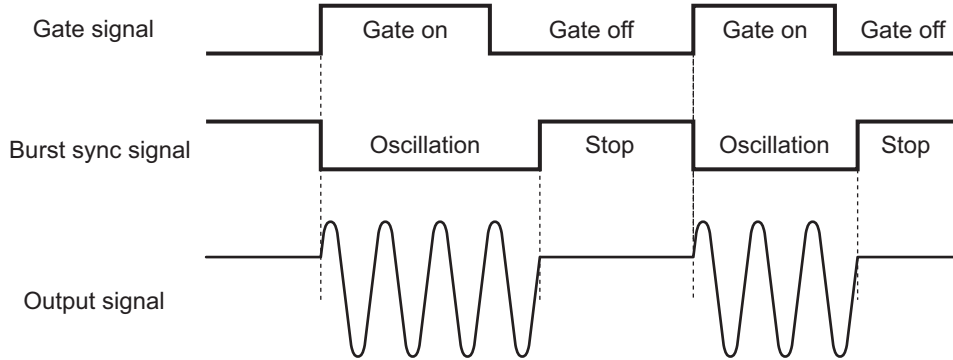

i) To execute oscillation in half-cycle units → Set oscillation stop unit to half cycle

To stop oscillation in half-cycle units, set [OscStop] (oscillation stop unit) on the 2nd page of the setting screen to [HalfCycle] (half cycle). Normally [Cycle] (1 cycle) is set. When [Cycle] (1 cycle) is set, oscillation is done in integer cycles.

The next figure compares oscillation done using 1 cycle and half cycle as the oscillation stop unit, under the following conditions: oscillation start/stop phase = 30°, stop level = off.

In the case of 1-cycle units, following gate off, oscillation stops once the oscillation start/stop phase is reached.

In the case of the half-cycle unit, following gate off, the oscillation stops once the oscillation start/stop phase or [oscillation start/stop phase + 180° (or - 180°)] is reached, and then the oscillation start/stop phase is transited to.

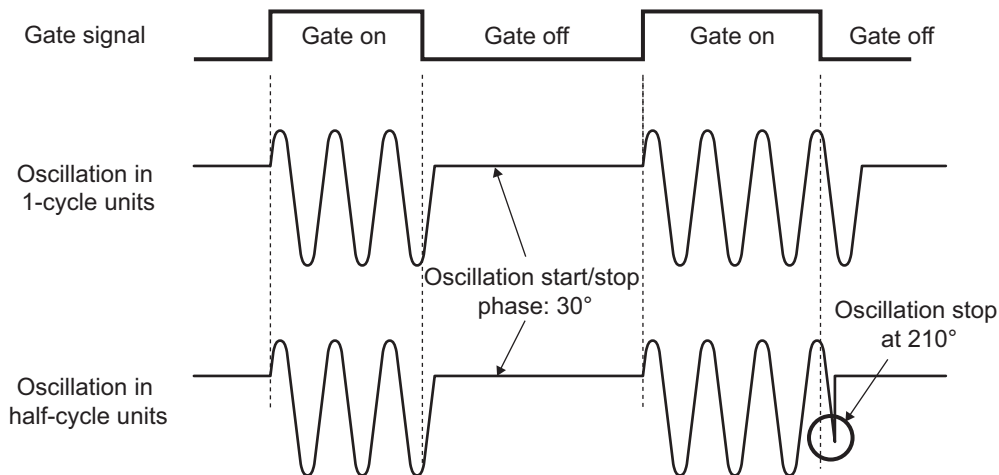

j) Usage of stop level

The level when oscillation is stopped is normally set with the oscillation start/stop phase, but it can also be set independently from that with a proportion of the amplitude full scale.

Set [StpLvl] (stop level) on the 2nd page of the setting screen to [On] (on) and set the level with a % value. ☞ p. 112

k) Noise gate oscillation

Noise having no cycle, the gate-on period is the oscillation period, and the gate-off period is the oscillation stop period. Further, since noise has no phase, the stop level setting is always enabled.

The next figure is an example of noise gate oscillation when the stop level is 0%.

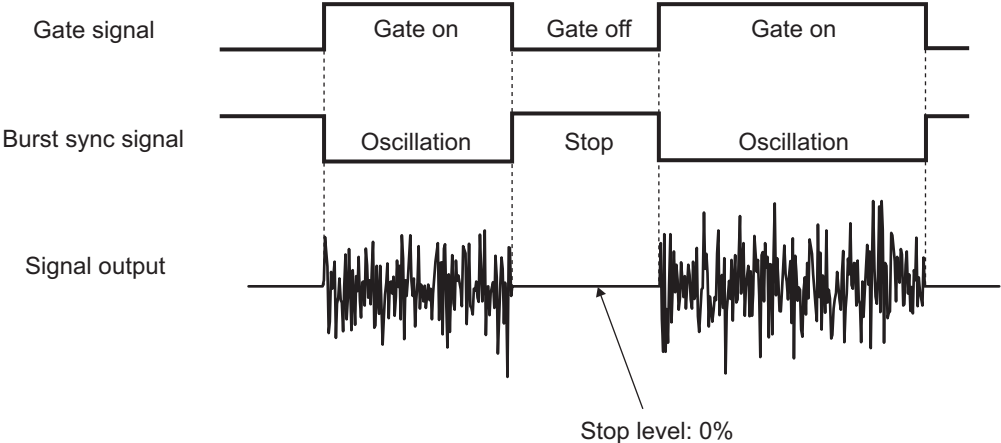

4.9.5 Triggered gate oscillation

Triggered gate oscillation is gate oscillation that switches the gate on/off each time a trigger is received.

The settings and manipulations are done on the Oscillator setting screen. “Oscillator” is displayed at the top left of the Oscillator setting screen. When another screen is displayed, press the **(MENU)** MENU key to display the top menu, then select [Oscillator] and press the **(ENTER)** ENTER key.

a) Triggered gate oscillation example

The following example is for oscillation start/stop phase = 30°, oscillation stop unit = 1 cycle, stop level: off.

After the gate signal becomes off, oscillation stops once the oscillation start/stop phase is reached.

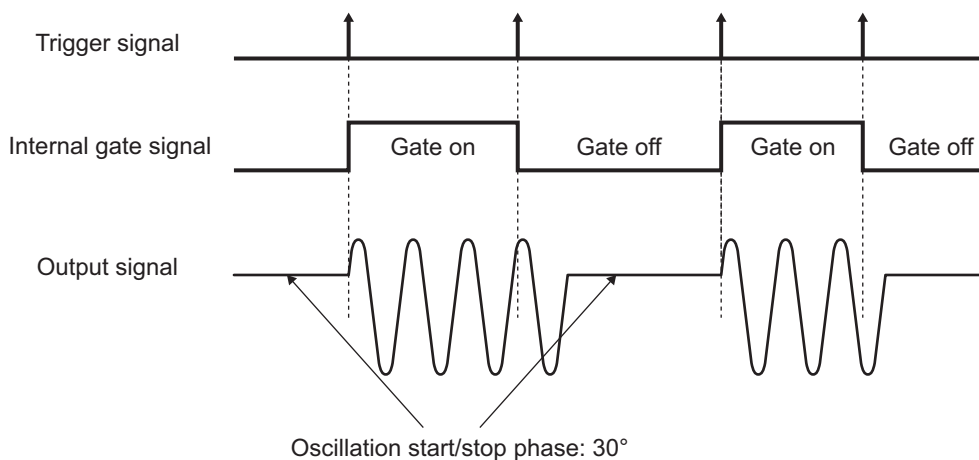

b) Setting the oscillation mode to triggered gate oscillation

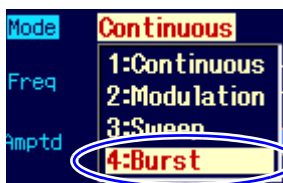

Select [Burst] in [Mode] and then press the ENTER key

Set [Mode] (oscillation mode) to [Burst] on the oscillator setting screen. The oscillation mode is switched to the burst oscillation mode as a result. In the burst oscillation mode, the setting screen consists of two pages, which can be toggled with the **(NEXT)** NEXT key.

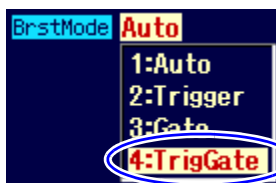

Select [TrigGate] in [BrstMode] and then press the ENTER key

Next, set [BrstMode] (burst mode) on the 2nd page of the burst oscillation mode setting screen to [TrigGate] (triggered gate oscillation).

c) Triggered gate oscillation setting screen

■ 1st page: Screen for the basic parameters

These are the common setting items that are common to all the oscillation modes.

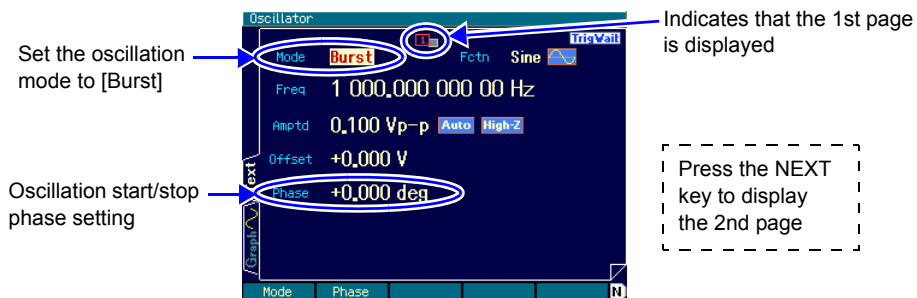

Oscillation start/stop phase [Phase]

This is the phase at which oscillation starts and stops.

■ 2nd page: Screen for the triggered gate oscillation settings

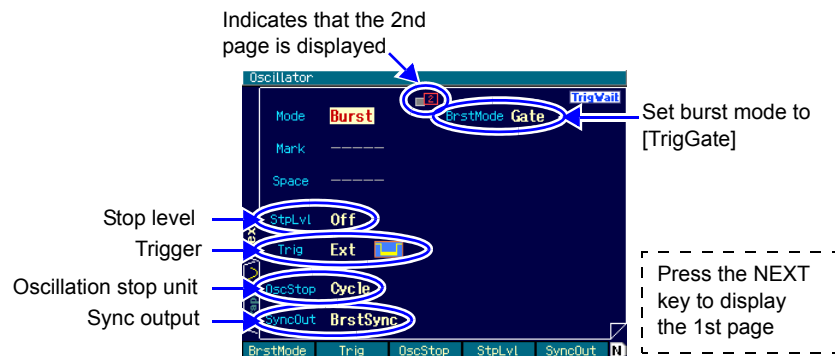

Stop level [StpLvl]

This is the signal level during oscillation stop. The level can be set to either off or on. Normally, it is set to off. ☞ p. 121

Trigger [Trig]

This is the trigger condition.

Internal and external can be chosen as the trigger source. ☞ p. 120

Oscillation stop unit [OscStop]

This is the oscillation stop unit. A choice can be made between 1-cycle unit and 0.5-cycle units. Normally, 1-cycle unit is set. ☞ p. 121

Sync output [SyncOut]

This is the output signal from the sync/sub-output terminal. Waveform reference phase synchronization and burst synchronization can be chosen from. ☞ p. 120

d) Waveforms for which triggered gate oscillation is not possible

Gate oscillation is not possible for DC.

Gate oscillation can be done for noise, but the operation differs from that of other waveforms. ☞ p. 121

e) Setting items required for triggered gate oscillation

Set [Phase] (oscillation start/stop phase) on the 1st page of the setting screen.

[StepLvl] (stop level) on the 2nd page of the setting screen is set to [Off] normally. ☞ p. 121

[OscStop] (oscillation stop unit) on the 2nd page of the setting screen is set to [Cycle] (1

cycle) normally. ☞ p. 121

A trigger is required for triggered gate oscillation. Refer to the following item.

f) Trigger settings for triggered gate oscillation

The trigger can be selected from internal trigger oscillator, external signal, manual trigger key manipulation, and remote trigger manipulation.

Upon receipt of a trigger, the TRIG'D lamp next to the MAN TRIG key lights.

The trigger source is set with [Trig] (trigger) on the 2nd page of the setting screen. The trigger delay is fixed to minimum.

■ Trigger source setting

The trigger source can be chosen from [Int] (internal) and [Ext] (external).

When the trigger source is [Int] (internal), the trigger period can be set.

When the trigger source is [Ext] (external), the trigger polarity can be set.

If the trigger source is set to [Ext] (external), a TTL level trigger signal is input to the external trigger input terminal (TRIG IN).

■ Usage of manual trigger and remote trigger

Manual trigger manipulation and remote trigger manipulation are always valid regardless of the trigger source setting.

The  MAN TRIG key can be used for manual trigger manipulation.

However, in the case of the WF1974, the MAN TRIG key works for the channel whose display is active.

For details on the channel whose display is active, ☞ p. 38.

To use only manual trigger manipulation and remote trigger manipulation as the trigger, set the trigger source to [Ext] (external). Also, to prevent malfunction due to external noise at this time, it is recommended to set the polarity to [Off].

g) To start triggered gate oscillation → Trigger

Oscillation is executed upon reception of a trigger if the internal gate signal is on.

The trigger can be selected from internal trigger oscillator, external signal, manual trigger manipulation, and remote trigger manipulation.

h) To output the burst sync signal → Sync output setting

This setting is done with [SyncOut] (sync output) on the 2nd page of the setting screen. One of the following two settings can be selected.

- Signal synchronized with the reference phase of the waveform [Sync]
- Signal synchronized with burst oscillation [BrstSync]

■ When [Sync] is selected

A TTL level signal that rises at the reference phase of the waveform is output from the sync/sub-output terminal.

■ When [BrstSync] is selected

A TTL level signal synchronized with the gate oscillation is output from the sync/sub-output terminal. As shown in the following figure, this signal is low during oscillation and high during oscillation stop. Note that this differs from the gate signal.

When the signal during burst is observed with an oscilloscope, it can be used as the trigger

signal for the oscilloscope.

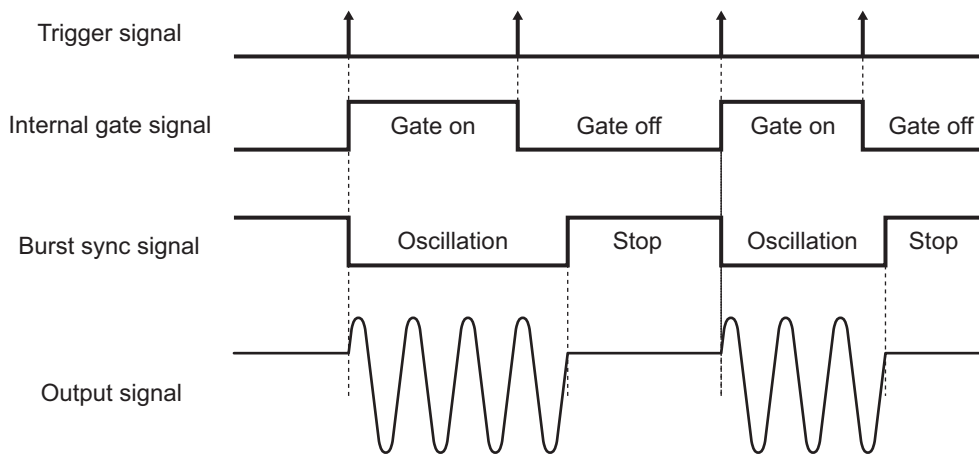

i) To execute oscillation in half-cycle units: Set oscillation stop unit to half cycle

To stop oscillation in half-cycle units, set [OscStop] (oscillation stop unit) on the 2nd page of the setting screen to [HalfCycle] (half cycle). Normally [Cycle] (1 cycle) is set. When [Cycle] (1 cycle) is set, oscillation is done in integer cycles. ☞ p. 116

j) Usage of stop level

The level when oscillation is stopped is normally set with the oscillation start/stop phase, but it can also be set independently from that with a proportion of the amplitude full scale.

Set [StpLvl] (stop level) on the 2nd page of the setting screen to [On] (on) and set the level with a % value. ☞ p. 112

k) Noise triggered gate oscillation

Noise having no cycle, the gate-on period is the oscillation period, and the gate-off period is the period stop interval. Further, since noise has no phase, the stop level setting is always enabled. ☞ p. 117

5. SAVING AND RECALLING SETTINGS

5.1 Saving Settings

The current setting conditions can be saved to the setting memory and then recalled for use. The setting saving operation is done on the Store Memory screen.

The settings when the power supply is cut off/restored are saved to setting memory No. 1.

☞ p. 24

a) Setting saving procedure

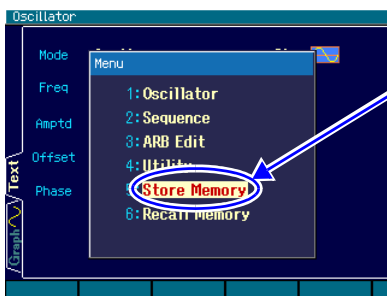

In the top menu, select [Store Memory] and then press the ENTER key.

1. Press the **[MENU]** MENU key to open the top menu window. In this window, select [Store Memory] and then press the **[ENTER]** ENTER key to display the Store Memory screen.

Select [Memory No.] in the top left of the screen and then press the ENTER key to open the field for inputting the number of the setting memory to which the setting is to be saved

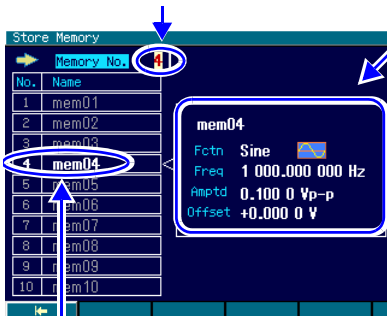

An outline of the setting in the specified setting memory number is displayed

2. On the Store Memory screen, select the [Memory No.] field and then press the **[ENTER]** ENTER key to open the field for inputting the number of the setting memory to which the setting is to be saved.

3. Increment/decrement the setting memory number with the **[Up/Down]** up/down arrow keys or the **[Modify]** modify knob.

The specified setting memory number and setting name are displayed in highlight in the left part of the screen. An outline of the setting saved to the setting memory of the specified number is displayed in the right part of the screen.

The specified setting memory number and the setting name are displayed in highlight

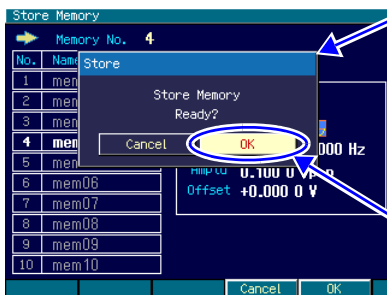

Press the [Store] soft key to open the dialog box for checking the saving operation

Select [OK] and then press the ENTER key to save the setting

4. Select the number of the setting memory to which the setting is to be saved and then press the **[ENTER]** ENTER key to close the setting memory number input field.

5. Press the [Store] soft key to open the dialog box in which the saving operation can be checked.

To save the setting, select [OK] and then press the **[ENTER]** ENTER key. The setting is saved, overwriting any setting previously saved to this setting memory number.

b) Restoring the saved contents to the initial settings

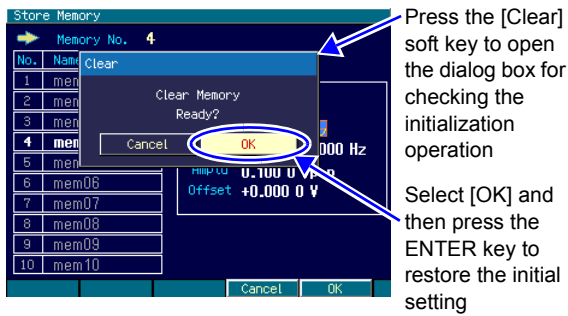

Press the [Clear] soft key to open the dialog box for checking the initialization operation

Select [OK] and then press the ENTER key to restore the initial setting

Similarly to the saving operation, after setting the setting memory number, press the [Clear] soft key. This opens the dialog box for checking the initialization operation. To perform initialization, select [OK] and then press the **ENTER** key. This causes the setting contents previously saved to that setting memory number to be overwritten with the initial setting contents.

c) Changing the setting memory name

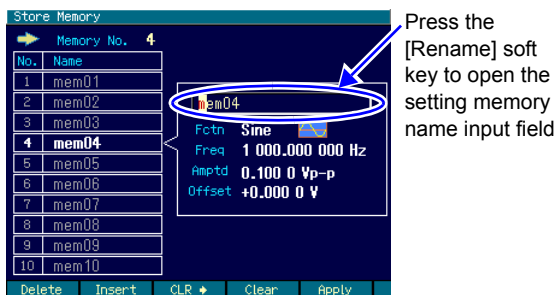

Press the [Rename] soft key to open the setting memory name input field

1. Similarly to the saving operation, after setting the setting memory number, press the [Rename] soft key to open the setting memory name input field.

2. Select the digit to be changed with the left/right arrow keys **◀▶**, and change the character with the **⬆️⬇️** up/down arrow keys or the **🔄** modify knob. Uppercase and lowercase alphabetic characters, numbers, and symbols can be input. Numeric values can be directly input by using the **0...9** numeric keypad.
Press the [Delete] soft key to delete the character at the cursor position. The character string to the right of the cursor moves one place left.
Press the [Insert] soft key to insert a space at the cursor position.
Press the [CLR ⇒] soft key to delete the character string to the right of the cursor position (cursor position not included).
Press the [Clear] soft key to delete all the characters.
The name may consist of up to 20 characters.
3. Press the [Apply] soft key or the **ENTER** key to fix the changed name and close the setting memory name input field.
When the **CANCEL** key is pressed here, the name remains unchanged and the setting memory name input field closes.

The setting memory name can also be changed on the Recall Memory screen.

✓ Check

The following characters can be used for the setting memory name.

A B C D E F G H I J K L M N O P Q R S T U V W X Y Z

a b c d e f g h i j k l m n o p q r s t u v w x y z

0 1 2 3 4 5 6 7 8 9

! # \$ % & ' () * + , - . / : ; < = > ? @ [] ¥ ^ _ ` { | } ~ space

5.2 Recalling Settings

The setting conditions saved to the setting memory can be recalled for use.

The setting recall operation is done on the Recall Memory screen.

At shipping, the same contents as the initial settings are saved to all the setting memories.

a) Setting recall procedure

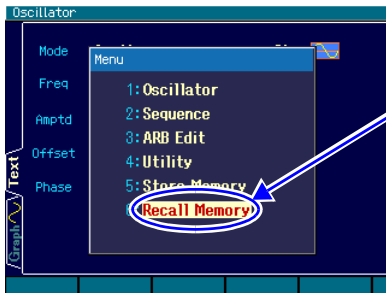

In the top menu, select [Recall Memory] and then press the ENTER key

Select [Memory No.] in the top left of the screen and then press the ENTER key to open the field for inputting the number of the setting memory to be recalled

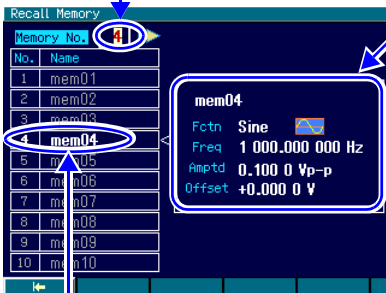

An outline of the setting in the specified setting memory number is displayed

The specified setting memory number and the setting name are displayed in highlight

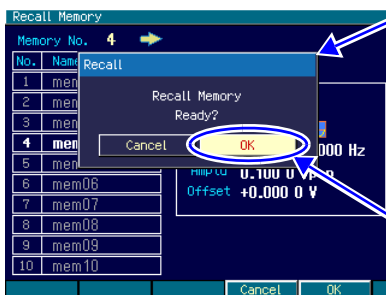

Press the [Recall] soft key to open the dialog box for checking the recall operation

Select [OK] and then press the ENTER key to execute recall

1. Press the **MENU** MENU key to display the top menu window. In this window, select [Recall Memory] and then press the **ENTER** ENTER key to display the Recall Memory screen.

2. In the Recall Memory screen, select the [Memory No.] field in the top left part of the screen and then press the **ENTER** ENTER key to open the field for inputting the number of the setting memory to be recalled.

3. Increment/decrement the setting memory number with the **▲▼** up/down arrow keys or the **◉** modify knob. The specified setting memory number and setting name are displayed in highlight in the left part of the screen. An outline of the setting saved to the setting memory of the specified number is displayed in the right part of the screen.

4. Select the number of the setting memory to be recalled and then press the **ENTER** ENTER key to close the setting memory number input field.

5. Press the [Recall] soft key to open the dialog box for checking the recall operation. To execute recall, select [OK] and then press the **ENTER** ENTER key. Recall is executed and the current setting contents are replaced with the recalled setting contents.

b) Changing the setting memory name

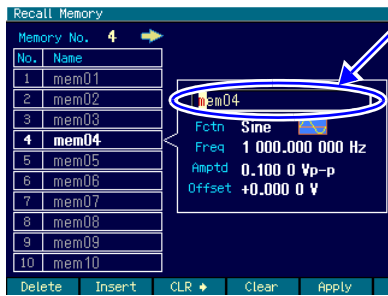

Press the [Rename] soft key to open the setting memory name input field

1. Similarly to the saving operation, after setting the setting memory number, press the [Rename] soft key to open the setting memory name input field.
2. The name input method is the same as in the case of the Store Memory screen.
 - ☞ p. 123

6. LIST OF INITIAL SETTINGS

The following initial settings are restored by executing [Reset] (setting initialization) on the Utility screen.

These items are also the targets to be saved in the setting memory (except for the output on/off setting).

The arbitrary waveform memory, setting memory, sequence memory, user-defined unit definition, output setting at power-on, panel operation setting, and remote setting are not initialized. Although the user-defined unit definition is not initialized, it is the target to be saved in the setting memory.

■ Output setting

Oscillation mode	Continuous oscillation
Waveform	Sine
Polarity and amplitude range	Normal, ±FS
Frequency	1 kHz
Amplitude	0.1 V _{p-p}
DC offset	0 V
Range	Auto
Load impedance	Open
Phase	0°
Output	Off
Sync/sub-output	Reference phase synchronization

■ Waveform

Square wave duty	Normal range, 50%
Pulse wave duty	50%
Pulse wave leading edge time, trailing edge time	1 μs
Ramp wave symmetry	50%
Parameter-variable waveform	Steady sine group, unbalanced sine

■ Modulation

Modulation type	FM
FM peak deviation	100 Hz
FSK hop frequency	1.1 kHz
PM peak deviation	90°
PSK deviation	90°
AM modulation depth	50%
DC offset modulation peak deviation	0.1 V
PWM peak deviation	10%
Modulation source	Internal, sine, 100 Hz
FSK, PSK external modulation input polarity	Positive
Sync/sub-output	Internal modulation synchronization

■ Sweep

Sweep type	Frequency
Frequency sweep range	1 kHz to 10 kHz
Phase sweep range	-90° to 90°
Amplitude sweep range	0.1 V _{p-p} to 0.2 V _{p-p}
DC offset sweep range	-0.1 V to 0.1 V
Duty sweep range	40% to 60%
Sweep time	0.1 s
Sweep mode	Continuous
Trigger source	Internal, 1 s
External trigger input polarity	Negative
Sweep function	One-way, linear
Mark values	5 kHz, 0°, 0.15 V _{p-p} , 0 V, 50%
Stop level	Off, 0%
External control input	Disabled
Oscillation stop unit during gated single-shot	1 cycle
Sync/sub-output	Sweep synchronization, marker on

■ Burst

Burst mode	Trigger burst
Mark wave number	1 cycle
Space wave number	1 cycle
Trigger source	Internal, 10 ms
External trigger input polarity	Negative
Trigger delay	0 s
Stop level	Off, 0%
Oscillation stop unit during gate	1 cycle
Sync/sub-output	Burst synchronization

■ 2-channel operation (WF1974 only)

Channel mode	Independent
Frequency difference	0 Hz
Frequency ratio	1:1
Same-value setting	Off

■ Other

Use of user-defined unit	Released
External 10 MHz frequency reference	Disabled
External addition	Off

The following settings are factory-default settings for items which do not return to their initial values even if initialization is executed once the settings are changed by the user.

■ User-defined unit definition

Unit name	usr1 to usr6
Calculation formula	$(h+n)*m$
m	1
n	0

■ Output settings at power-on and power operation settings

Output at power-on	Off
Display	Backlight on, dark color
Modify direction	Downward through clockwise rotation
Operation sound	On

■ Remote settings

Interface	USB
GPIB address	2

The following settings are initialized every time the power is switched on.

■ Sequence

Start step	1
Trigger polarity	Off
External control input	Disabled
External control start/state branch	Start
Sync/sub-output	Step synchronization
Step time	1 s
Auto hold	Off
Jump destination	Off
Number of jumps	Infinite
Stop phase	Off
State branch	Off
Event branch	Off
Control of step termination	Go to next step
Step code	LLLL
Internal step operation	Constant
Channel parameters	Equal to initial settings

7. SPECIFICATIONS

The values of items marked with *1 are guaranteed values. All other values are either nominal values or typical (typ.) values, and are not guaranteed.

Conditions unless otherwise mentioned are as follows: Continuous oscillation, 50 Ω load, 10 V_{p-p}/50 Ω amplitude setting, 0 V DC offset setting, auto-range, \pm FS waveform amplitude range, external addition off, AC voltage = RMS value measurement.

7.1 Oscillation Modes

Continuous, modulated, sweep, burst, sequence

7.2 Waveforms

7.2.1 Standard waveforms

Types	Sine, square, pulse, ramp, parameter-variable waveform, noise (Gaussian distribution), DC
Polarity	Normal, inverted (selectable) (excluding DC)
Amplitude range	-FS/0, \pm FS, 0/+FS (selectable) (excluding DC)

7.2.2 Arbitrary waveforms

Waveform length	4 K to 512 K words (2^n , n = 12 to 19) or 2 to 10,000 control points (linear interpolation between control points)
Total waveform saving capacity	Up to 128 waveforms or 4 M words (combined total for channels 1 and 2) Saved to non-volatile memory
Waveform data amplitude resolution	16 bits
Sampling rate	120 MS/s
Polarity	Normal, inverted (selectable)
Amplitude range	-FS/0, \pm FS, 0/+FS (selectable)
Output bandwidth	25 MHz, -3 dB

7.3 Frequency, Phase

Frequency setting range

Oscillation Mode Waveform	Continuous, Modulated, Sweep (Continuous, Single-Shot)	Sweep (Gated Single- Shot), Burst	Sequence
Sine	0.01 μ Hz to 30 MHz	0.01 μ Hz to 10 MHz	0.01 μ Hz to 10 MHz
Square	0.01 μ Hz to 15 MHz	0.01 μ Hz to 10 MHz	0.01 μ Hz to 10 MHz
Pulse	0.01 μ Hz to 15 MHz	0.01 μ Hz to 10 MHz	Not usable
Ramp	0.01 μ Hz to 5 MHz		0.01 μ Hz to 5 MHz ^{*2}
Parameter-variable waveform	0.01 μ Hz to 5 MHz		0.01 μ Hz to 5 MHz ^{*2}
Noise	Fixed to 26 MHz equivalent bandwidth		
DC	Frequency setting invalid		
Arbitrary	0.01 μ Hz to 5 MHz		

*2: Used through conversion to arbitrary waveform

Frequency setting resolution	0.01 μ Hz
Frequency setting by period	Setting equivalent to inverse number of the set period
Frequency accuracy at shipping ^{*1}	$\pm(3 \text{ ppm of setting} + 2 \text{ pHz})$
Frequency aging rate ^{*1}	$\pm 1 \text{ ppm/year}$
Phase setting range	-1800.000° to $+1800.000^\circ(0.001^\circ \text{ resolution})$

7.4 Output Characteristics

7.4.1 Amplitude

Setting range	0 Vp-p to 20 Vp-p/open, 0 Vp-p to 10 Vp-p/50 Ω Peak value combining waveform amplitude and DC offset is limited to $\pm 10 \text{ V/open}$ or lower.
Setting resolution	999.9 mVp-p or lower 4 digits or 0.1 mVp-p 1 Vp-p or higher 5 digits or 1 mVp-p
Accuracy ^{*1}	$\pm(1\% \text{ of amplitude setting [Vp-p]} + 2 \text{ mVp-p})/\text{open}$ Condition: 1 kHz sine, amplitude setting of 20 mVp-p/ open or higher
Setting units	Vp-p, Vpk, Vrms, dBV, dBm
Range	Auto, hold (selectable) Maximum output voltage range: 20 Vp-p, 4 Vp-p Amplitude attenuator range: 0 dB, -10 dB, -20 dB, -30 dB
Waveform amplitude resolution	Approx. 14 bits Condition: Amplitude setting of 36 mVp-p/open or higher

7.4.2 DC offset

Setting range	$\pm 10 \text{ V/open}$, $\pm 5 \text{ V}/50 \Omega$
Setting resolution	$\pm 499.9 \text{ mV}$ or lower 4 digits or 0.1 mV $\pm 0.5 \text{ V}$ or higher 5 digits or 1 mV

Accuracy* ¹	$\pm(1\% \text{ of DC offset setting [V] +5\text{mV} + 0.5\% \text{ of amplitude setting [Vp-p]}/\text{open}$ Condition: Sine wave output of 10 MHz or lower, 20°C to 30°C Outside 20°C to 30°C temperature range, 1 mV/°C typ. is added
------------------------	---

7.4.3 Load impedance setting

Functions	Setting and display of the amplitude and DC offset for the output termination voltage under the specified load condition.
Setting range	1 Ω to 10 k Ω (1 Ω resolution), 50 Ω , High-Z (load open)

7.4.4 Waveform output

Output on/off control	On, Off (selectable) (When Off, output pin open state)
Output impedance	50 Ω , unbalanced
Short-circuit protection	Protection against short circuit to signal GND
Output connector	Front panel, BNC receptacle

7.4.5 Sync/sub output

Output signal	Reference phase sync, internal modulation sync, burst sync, sweep sync, sequence step sync, internal modulation signal, sweep X drive (selectable)
Reference phase sync output waveform	Square waveform with 50% duty that rises at zero phase position of reference phase (DDS oscillation phase) of waveform output
Output voltage	Sync signals: TTL level (low level 0.4 V/open or lower, high level 2.7 V/open or higher) Internal modulation signal: -3 V to +3 V/open Sweep X drive: 0 V to +3 V/open
Output impedance	50 Ω , unbalanced
Load impedance	50 Ω or higher recommended
Output connector	Front panel, BNC receptacle

7.5 Signal Characteristics

7.5.1 Sine wave

Amplitude frequency characteristics* ¹	
100 kHz or lower	± 0.1 dB
100 kHz to 5 MHz	± 0.15 dB
5 MHz to 20 MHz	± 0.3 dB
20 MHz to 30 MHz	± 0.5 dB (± 0.8 dB at amplitude setting of 2.8 Vp-p/50 Ω or higher)
	Condition: Amplitude setting 50 mVp-p to 10 Vp-p/50 Ω , reference frequency 1 kHz
Total harmonic distortion* ¹	
10 Hz to 20 kHz	0.2% or less
	Condition: Amplitude setting of 0.5 Vp-p to 10 Vp-p/50 Ω

Harmonic spurious* ¹		
Condition: Amplitude setting	0.5 V _{p-p} to 2 V _{p-p} /50 Ω	2 V _{p-p} to 10 V _{p-p} /50 Ω
1 MHz or lower	-60 dBc or lower	-60 dBc or lower
1 MHz to 10 MHz	-50 dBc or lower	-43 dBc or lower
10 MHz to 30 MHz	-40 dBc or lower	-30 dBc or lower
Non-harmonic spurious* ¹		
1 MHz or lower	-60 dBc or lower	
1 MHz to 10 MHz	-50 dBc or lower	
10 MHz to 30 MHz	-45 dBc or lower	
Condition: Amplitude setting of 0.5 V _{p-p} to 10 V _{p-p} /50 Ω		

7.5.2 Square wave

Duty	
Variable range selectable	Normal, extended (selectable)
Normal range	Duty can be changed in range with little jitter and no pulse loss. The higher the frequency, the narrower the duty setting range.
Extended range	With 2.5 ns rms or less typ. jitter, duty can be changed always in maximum range. In the case of a pulse width of 8.4 ns or less, loss may occur; on average, it is equal to the set duty.
Setting range	
Normal range	0.0100% to 99.9900% (0.0001% resolution) Upper limit (%): 100 – frequency (Hz) / 300,000 Lower limit (%): frequency (Hz) / 300,000
Extended range	0.0000% to 100.0000% (0.0001% resolution)
Duty accuracy* ¹	
100 kHz or lower	±0.1% of period (duty setting 1% to 99%)
100 kHz to 1 MHz	±1% of period (duty setting 5% to 95%)
1 MHz to 3 MHz	±3% of period (duty setting 40% to 60%)
Rising/falling time* ¹	
	17 ns or less However, approx. 20 ns in the case of burst oscillation with stop level setting, gated single-shot sweep with stop level setting, and sequence oscillation
Overshoot	5% or less typ.
Jitter	Normal variable duty range: 300 ps rms or less typ. (100 Hz or higher) Extended variable duty range: 2.5 ns rms or less typ.

7.5.3 Pulse wave

Pulse width	
Duty setting range	0.0170% to 99.9830% (0.0001% resolution)
Time setting range	25.50 ns to 99.9830 Ms (0.001% or less of period, or 0.01 ns resolution)

Leading edge time, trailing edge time

Setting range 15.0 ns to 58.8 Ms (3 digits or 0.1 ns resolution)
Leading edge time and trailing edge time independently settable

Minimum setting value Largest of either 0.01% of period or 15 ns

Pulse width, leading edge time, trailing edge time limits

The pulse width time, leading edge time, trailing edge time, and period are mutually constrained by the following equations.

The duty is converted from pulse width time / period.

$$(\text{leading edge time} + \text{trailing edge time}) \times 0.85 \leq \text{pulse width time}$$

$$\text{pulse width time} \leq \text{period} - (\text{leading edge time} + \text{trailing edge time}) \times 0.85$$

Overshoot 5% or less typ.

Jitter 500 ps rms or less typ. (10 kHz or higher)
2.5 ns rms or less typ. (under 10 kHz)

7.5.4 Ramp wave

Symmetry setting range 0.00% to 100.00% (0.01% resolution)

7.5.5 Parameter-variable waveforms

a) Steady sine group

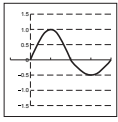
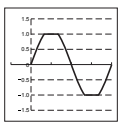
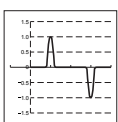
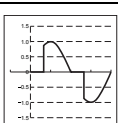
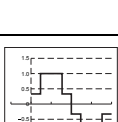
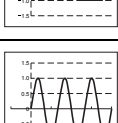
Waveform Name	Waveform Example	Description and Variable Parameters
Unbalanced sine		Waveform for which the amplitudes of the first half cycle and second half cycle of a sine wave can be changed independently
		First-half amplitude (-100.00% to 100.00%) Second-half amplitude (-100.00% to 100.00%)
Clipped sine		Waveform obtained by clipping the top and bottom of the amplitude of a sine wave
		Clip rate (0.00% to 99.99%)
CF controlled sine		Waveform obtained by extracting only the 90° and 270° neighborhood of a sine wave and expanding the amplitude
		Crest factor (1.41 to 10.00)
Conduction angle controlled sine		Waveform obtained by extracting only the front or back of each half cycle of a sine wave
		Conduction angle (-180.00° to 180.00°) Remark: In the case of a positive/negative conduction angle, back/front conduction angle
Staircase sine		Staircase shaped sine wave
		Number of steps (2 to 100)
Multi-cycle sine		Waveform obtained by continuing sine for several cycles
		Number of cycles (0.01 to 50.00) Start phase (-360.00° to 360.00°)

b) Transient sine group

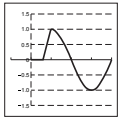
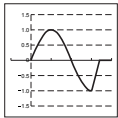
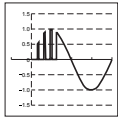
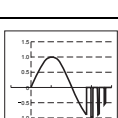
Waveform Name	Waveform Example	Description and Variable Parameters
On-phase controlled sine		Sine wave with slope into on state
		Complete-on phase (0.00° to 360.00°) On-slope time (0.00% to 50.00% of basic period)
Off-phase controlled sine		Sine wave with slope into off state
		Off-phase (0.00° to 360.00°) Off-slope time (0.00% to 50.00% of basic period)
Chattering-on sine		Sine wave with chattering into on state
		On-phase (0.00° to 360.00°) Number of chatterings (0 to 3) On-state time (0.00% to 20.00% of basic period) Off-state time (0.00% to 20.00% of basic period)
Chattering-off sine		Sine wave with chattering into off state
		Off-phase (0.00° to 360.00°) Number of chattering (0 to 3) On-state time (0.00% to 20.00% of basic period) Off-state time (0.00% to 20.00% of basic period)

c) Pulse group

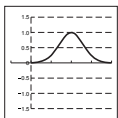
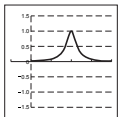
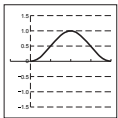
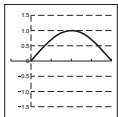
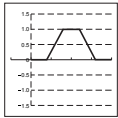
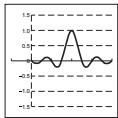
Waveform Name	Waveform Example	Description and Variable Parameters
Gaussian pulse		Gaussian distribution waveform
		Standard deviation (0.01% to 100.00% of basic period)
Lorentz pulse		Lorentz waveform
		Half value of width (0.01% to 100.00% of basic period)
Haversine		Sin ² pulse
		Width (0.01% to 100.00% of basic period)
Half-sine pulse		Half-sine cycle pulse
		Width (0.01% to 100.00% of basic period)
Trapezoid pulse		Trapezoid pulse
		Slope width (0.00% to 50.00% of basic period) Upper base width (0.00% to 100.00% of basic period)
Sin(x)/x		Sin(x)/x waveform
		Number of zero crossings (1 to 50)

d) Transient response group

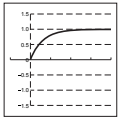
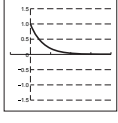
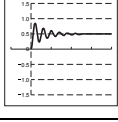
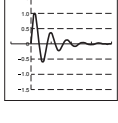
Waveform Name	Waveform Example	Description and Variable Parameters
Exponential rise		First order LPF step response waveform
		Time constant (0.01% to 100.00% of basic period)
Exponential fall		First order HPF step response waveform
		Time constant (0.01% to 100.00% of basic period)
Second order LPF step response		Second order LPF step response waveform
		LPF natural frequency (1.00 to 50.00 times basic frequency) LPF Q (0.50 to 50.00)
Damped oscillation		Oscillation waveform with an amplitude that decreases exponentially
		Oscillation frequency (0.01 to 50.00 times basic frequency) Damping time constant (-100.00% to 100.00% of basic period) Remark: In the case of a negative damping time constant, oscillation waveform with an amplitude that increases exponentially

e) Surge group

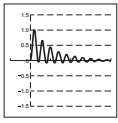
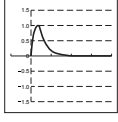
Waveform Name	Waveform Example	Description and Variable Parameters
Oscillation surge		Surge waveform with damped oscillation
		Oscillation frequency (0.01 to 50.00 times basic frequency)
		Damping time constant (0.01% to 100.00% of basic period) Trailing time constant (0.01% to 100.00% of basic period)
Pulse surge		Pulsed surge waveform
		Rising time (0.01% to 100.00% of basic period) Duration time (0.01% to 100.00% of basic period) Remark: The rising time represents the time from the 10% threshold to the 90% threshold of the rising edge. The duration time represents the time from the 10% threshold of the rising edge to the 10% threshold of the next falling edge.

f) Other waveform group

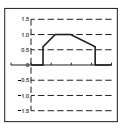
Waveform Name	Waveform Example	Description and Variable Parameters
Trapezoid with offset		Trapezoid waveform with offset in the amplitude direction
		Leading delay (0.00% to 100.00% of basic period)
		Rising-slope width (0.00% to 100.00% of basic period)
		Upper base width (0.00% to 100.00% of basic period)
		Falling-slope width (0.00% to 100.00% of basic period) Offset (0.00% to 100.00%)

7. SPECIFICATIONS

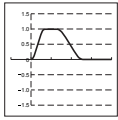
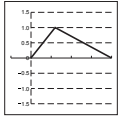
Waveform Name	Waveform Example	Description and Variable Parameters
Half-sine edge pulse		Pulse whose rise and fall are half-sine waveform
		Leading edge time (0.00% to 100.00% of basic period)
		Trailing edge time (0.00% to 100.00% of basic period) Duty (0.00% to 100.00%)
Bottom referenced ramp		Ramp waveform with bottom level as reference
		Symmetry (0.00% to 100.00%)

7.6 Modulated Oscillation Mode

7.6.1 General

Modulation type	FM, FSK, PM, PSK, AM, DC offset modulation, PWM
Modulation source	Internal, external (selectable)
Internal modulation waveform	
Other than FSK, PSK	Sine wave, square wave (50% duty), triangular wave (50% symmetry), rising ramp wave, falling ramp wave, noise, arbitrary wave
FSK, PSK	Square wave (50% duty)
Internal modulation frequency	
Other than FSK, PSK	0.1 mHz to 100 kHz (5 digits or 0.1 mHz resolution)
FSK, PSK	0.1 mHz to 1 MHz (5 digits or 0.1 mHz resolution)
Internal modulation sync output	
Output waveform	Square wave with 50% duty that rises at zero phase position of internal modulation waveform Fixed to low level while internal modulation waveform is noise
Output connector	Shared with sync/sub-output connector
Internal modulation signal output	
Output voltage	-3 V to +3 V/open
Output connector	Shared with sync/sub-output connector
External modulation input (other than FSK, PSK)	
Input voltage range	±1 V full scale
Maximum allowed input	±2 V
Input impedance	10 kΩ, unbalanced
Input frequency	DC to 25 kHz
Input connector	Front panel (WF1973) / rear panel (WF1974) BNC receptacle Shared with external addition input, cannot be used simultaneously with adding operation
External modulation input (FSK, PSK)	
Polarity	Positive, negative (selectable)
Input frequency	DC to 1 MHz

Input connector	Use of external trigger input. Input voltage and input impedance follow the external trigger input specifications.
-----------------	---

7.6.2 Modulation conditions

■ FM

Carrier waveform	Standard waveform other than noise, pulse wave and DC, and arbitrary waveform
Peak deviation setting range	0.00 μ Hz to less than 15 MHz (8 digits or 0.01 μ Hz resolution)

■ FSK

Carrier waveform	Standard waveform other than noise, pulse wave and DC, and arbitrary waveform
Hop frequency setting range	Within settable carrier waveform frequency range (8 digits or 0.01 μ Hz resolution)

■ PM

Carrier waveform	Standard waveform other than noise and DC, and arbitrary waveform
Peak deviation setting range	0.000° to 180.000° (0.001° resolution)

■ PSK

Carrier waveform	Standard waveform other than noise and DC, and arbitrary waveform
Deviation setting range	-1800.00° to +1800.000° (0.001° resolution)
Remark	The sine wave amplitude frequency characteristics during PSK are limited to 25 MHz, -3 dB.

■ AM (non-DSB-SC)

Carrier waveform	Standard waveform other than DC, and arbitrary waveform
Modulation depth setting range	0.0% to 100.0% (0.1% resolution)
Remark	When the modulation depth is 0%, the amplitude is 1/2 of the set value.

■ AM (DSB-SC) (Double Side Band - Suppressed Carrier)

Carrier waveform	Standard waveform other than DC, and arbitrary waveform
Modulation depth setting range	0.0% to 100.0% (0.1% resolution)
Remark	When the modulation depth is 100%, the maximum amplitude is equal to the set value. During DSB-SC, the carrier frequency component is zero.

■ DC offset modulation

Carrier waveform	Standard waveform and arbitrary waveform
Peak deviation setting range	0 V to 10 V/open

■ PWM

Carrier waveform	Square wave, pulse wave
Peak deviation setting range	
Square wave	
Normal variable duty range	0.0000% to 49.9900% (0.0001% resolution)

Extended variable duty range	0.0000% to 50.0000% (0.0001% resolution)
Pulse wave	0.0000% to 49.9000% (0.0001% resolution)

7.7 Sweep Oscillation Mode

7.7.1 General

Sweep types	Frequency, phase, amplitude, DC offset, duty
Sweep functions	One-way (ramp waveform shape), shuttle (triangular waveform shape) (selectable) Linear, log (frequency sweep only) (selectable)
Sweep range setting	Start value and stop value specification Center value and span value specification.
Sweep time setting range	0.1 ms to 10,000s (4 digits or 0.1 ms resolution)
Sweep mode	Continuous, single-shot, gated single-shot (selectable) During gated single-shot, oscillation occurs only during sweep execution.
Operation	Start, stop, hold/resume, start value output, stop value output
Trigger source (used for single-shot sweep and gated single-shot sweep)	Internal, external (selectable) Trigger delay setting is invalid. Manual trigger possible.
Internal trigger oscillator for sweep (used for single-shot sweep and gated single-shot sweep)	
Period setting range	100.0 μ s to 10,000 s (5 digits or 0.1 μ s resolution)
Stop level setting (used for gated single-shot sweep)	
Function	Specification of signal level while oscillation is stopped during gated single-shot sweep
Setting range	-100.00% to +100.00% of amplitude full scale (0.01% resolution) or off
Oscillation stop unit during gated single-shot	1 cycle, 0.5 cycles (selectable)
Sweep sync/marker output	
Marker off, one-way sweep	Low level from sweep start value to half of sweep time. High level at any other time.
Marker off, shuttle sweep	Low level from sweep start value to sweep stop value. High level at any other time.
Marker on	Low level from sweep start value until marker value. High level at any other time.
Output connector	Shared with sync/sub-output connector
Sweep X drive output	
Output voltage	0 V to +3 V/open 0 V \rightarrow +3 V during sweep value rise +3 V \rightarrow 0 V during sweep value fall
Output connector	Shared with sync/sub-output connector
Sweep external control input	
Input connector	Use of 3 bits of multi-I/O connector
Control items	Start, stop, hold/resume

Sweep external trigger input (used for single-shot sweep and gated single-shot sweep)

Polarity	Positive, negative, off (selectable)
Input connector	Use of external trigger input. Input voltage and input impedance follow the external trigger input specifications.

7.7.2 Sweep conditions

■ Frequency sweep

Waveform	Standard waveform other than noise, pulse wave, and DC, and arbitrary waveform
Start, stop frequency setting range	0.01 μ Hz to 30 MHz (0.01 μ Hz resolution)

■ Phase sweep

Waveform	Standard waveform other than noise and DC, and arbitrary waveform
Start, stop phase setting range	-1800.000° to 1800.000° (0.001° resolution)

■ Amplitude sweep

Waveform	Standard waveform other than DC, and arbitrary waveform
Start, stop amplitude setting range	0 Vp-p to 20 Vp-p/open

■ DC offset sweep

Waveform	Standard waveform and arbitrary waveform
Start, stop DC offset setting range	-10 V to +10 V/open

■ Duty sweep

Waveform	Square wave, pulse wave
Start, stop duty setting range	
Square wave	
Normal variable duty range	0.0100% to 99.9900% (0.0001% resolution)
Extended variable duty range	0.0000% to 100.0000% (0.0001% resolution)
Pulse wave	0.0170% to 99.9830% (0.0001% resolution)

7.8 Burst Oscillation Mode

Burst mode

Auto burst	Repeats oscillation of mark wave number and oscillation stop of space wave number. Trigger invalid.
Trigger burst	Performs oscillation of mark wave number in sync with trigger.
Gate	Performs oscillations in cycles of integers or integer multiples of half-cycles, in sync with the gate signal. However, if the waveform is noise, oscillation on/off operation is done through the gate signal.
Triggered gate	Gate oscillation switched on/off by gate upon trigger
Target waveforms	
Auto, trigger burst	Standard waveform other than noise and DC, and arbitrary waveform
Gate, triggered gate	Standard waveform other than DC, and arbitrary waveform

Setting range of mark wave number	0.5 cycles to 999,999.5 cycles, in 0.5-cycle units
Setting range of space wave number	0.5 cycles to 999,999.5 cycles, in 0.5-cycle units
Oscillation stop unit during gate	1 cycle, 0.5 cycles (selectable)
Oscillation start/stop phase setting range	-1800.000° to +1800.000° (0.001° resolution) Remark: Same setting value as phase setting in section 7.3
Stop level setting range	
Function	Specification of signal level when oscillation is stopped
Setting range	-100.00% to +100.00% of amplitude full scale (0.01% resolution) or off When the stop level is set to off, stop occurs at the set oscillation start/stop phase
Trigger source (used during other than auto burst)	Internal, external (selectable). Manual trigger possible.
Internal trigger oscillator for burst (used during other than auto burst)	
Period setting range	1.0 μ s to 1,000 s (5 digits or 0.1 μ s resolution)
Trigger delay setting range	0.00 μ s to 100.00 s (5 digits or 0.01 μ s resolution) Latent delay of 0.55 μ s Only valid for trigger burst (not valid for gate, triggered gate) Valid for both internal and external trigger sources. Not valid for manual trigger.
Trigger jitter	1 ns rms or less typ.
Burst sync output	
Polarity	Low level during oscillation. High level at all other times.
Output connector	Shared with sync/sub-output connector

7.9 Triggers

External trigger input	
Applications	Used for single-shot sweep, gated single-shot sweep, trigger burst, gate, triggered gate, and sequence
Input voltage	TTL level (low level of 0.8 V or lower, high level of 2.6 V or higher)
Maximum allowed input	-0.5 V to +5.5 V
Polarity	Positive, negative, off (selectable) FSK and PSK, sweep, sequence (independently settable)
Minimum pulse width	50 ns
Input impedance	10 k Ω (pulled up to +3.3 V), unbalanced
Input connector	Front panel (WF1973) / rear panel (WF1974) BNC receptacle
Manual trigger	Panel key operation
Applications	Used for single-shot sweep, gated single-shot sweep, trigger burst, gate, triggered gate
Internal trigger oscillator	Independent for sweep and burst Refer to internal trigger oscillator of each section.

7.10 Sequence

Number of saved sequences	10 sequences (saved to non-volatile memory)
Maximum number of steps	Maximum of 255 steps per sequence (not including step of pre-start status)
Inter-channel operation	In sequence mode, the mode of both channels is the sequence mode. Step control is done in common for both channels.
Step control parameters	Step time, hold operation, jump destination, number of jumps, step stop phase, branch operation, step termination control, step sync code output
Intra-step channel parameters	Waveform, frequency, phase, amplitude, DC offset, square wave duty
In-step operations	Constant, keep, linear interpolation (except waveform switching)
Step time setting range	0.1 ms to 1,000 s (4 digits or 0.01 ms resolution)
Jump count setting range	1 to 999 or infinite
Step stop phase setting range	0.000° to 360.000° (CH1 reference phase. 0.001° resolution) or invalid
Branch operation	
State branch	Check of state branch input from multi-I/O connector at step end. Upon branch input detection, branching to specified destination step
Event branch	Immediate branching to specified destination step through event branch manipulation or input
Control of step termination	Sequence end or transition to next step
Step sync code output	Output of 4-bit code specified for each step to multi-I/O connector LSB outputtable to sync/sub-output connector
Usable waveforms	Sine wave, square wave, noise, DC, and arbitrary wave Ramp wave and parameter-variable waveform can be used through saving as arbitrary waveforms.
Maximum number of usable waveforms	128
Step start phase	Oscillation start from reference phase 0° of each channel at next step after DC or noise (excluding DC and noise)
Sequence manipulations	Start, stop, hold/resume, event branch
Sequence external control	
Input connector	Use of 4 bits of multi-I/O connector
Control items	Start or state branch, stop, hold/resume, event branch
Sequence external trigger input (start trigger)	
Polarity	Positive, negative, off (selectable)
Input connector	Use of external trigger input on CH1 side. Input voltage and input impedance follow the external trigger input specifications.

7.11 Other I/Os

External 10 MHz frequency reference input

Frequency reference selection	External reference enable, disable (selectable)
Input voltage	0.5 Vp-p to 5 Vp-p
Maximum allowed input	10 Vp-p
Input impedance	1 k Ω , unbalanced, AC coupled
Input frequency	10 MHz ($\pm 0.5\%$ (± 50 kHz))
Input waveform	Sine wave or square wave (50 $\pm 5\%$ duty)
Input connector	Rear panel, BNC receptacle

Frequency reference output (for synchronizing multiple WF1973, WF1974 units)

Output voltage	1 Vp-p/50 Ω square wave
Output impedance	50 Ω , AC coupled
Output frequency	10 MHz
Output connector	Rear panel, BNC receptacle

External addition input

Addition gain	$\times 2$, $\times 10$, off (selectable) During $\times 2$, the maximum output voltage range is fixed to 4 Vp-p, and during $\times 10$, 20 Vp-p. Off during sequence oscillation
Input voltage	-1 V to +1 V
Maximum allowed input	± 2 V
Input frequency	DC to 10 MHz (-3 dB)
Input impedance	10 k Ω , unbalanced
Input connector	Front panel (WF1973) / rear panel (WF1974) BNC receptacle Shared with external modulation input, cannot be used during external modulation

Multi-I/O

Applications	Sweep control, sequence control
Input voltage	TTL level (low level of 0.8 V or lower, high level of 2.6 V or higher. Pulled up to +5 V through 10 k Ω)
Maximum allowed input	-0.5 V to +5.5 V
Output voltage	TTL level (low level of 0.4 V/open or lower, high level of 2.7 V/open or higher)
Connector	Rear panel, Mini-Dsub 15-pin multiconnector

7.12 2-channel ganged operation (WF1974 only)

Channel modes

Channel Mode	Operation
Independent	Independent setting
2-phase	Holds same frequency. During frequency sweep, internal frequency modulation, and internal FSK, the same frequency is controlled to be held. External frequency modulation and external FSK are not possible. Phase independently set for each channel.
Constant frequency difference	Holds the frequency difference as a constant value. During frequency sweep, internal frequency modulation, and internal FSK, the frequency difference is controlled to be held. External frequency modulation and external FSK are not possible.
Constant frequency ratio	Holds the frequency ratio as a constant value. During frequency sweep, internal frequency modulation, and internal FSK, the frequency ratio is controlled to be held. External frequency modulation and external FSK are not possible.
Differential output	Same frequency, amplitude, and DC offset. Reverse phase waveform. Differential output is controlled to be held during all types of sweep and internal modulation. External modulation and external addition are not possible.

Common limiting conditions during 2-phase, constant frequency difference, constant frequency ratio, and differential output

- Oscillation in same oscillation mode (also same modulation type during modulated oscillation, and same sweep type during sweep oscillation)
- Applicable to standard waveform other than noise and DC, and arbitrary waveform
- Burst, gated single-shot sweep not possible

Same value setting, same manipulation

Yes

Frequency difference setting range 0.00 μ Hz to less than 30 MHz (0.01 μ Hz resolution)
CH2 frequency – CH1 frequency

Frequency ratio N:M setting range 1 to 9,999,999 (for each of N and M)
N:M = CH2 frequency:CH1 frequency

Phase synchronization

Automatically executed during channel mode switching

Time difference between channels during 2-phase*¹

± 20 ns or less (± 10 ns or less typ.)

Condition: Same waveform (sine or square)

7.13 Synchronous Operation of Multiple Units

Connection

Connection method 1

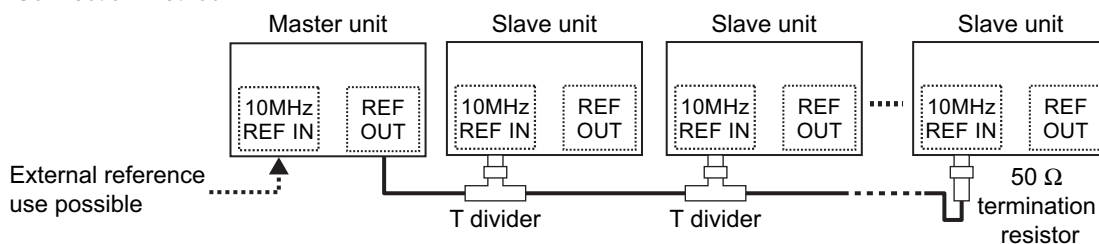

Connection method 2

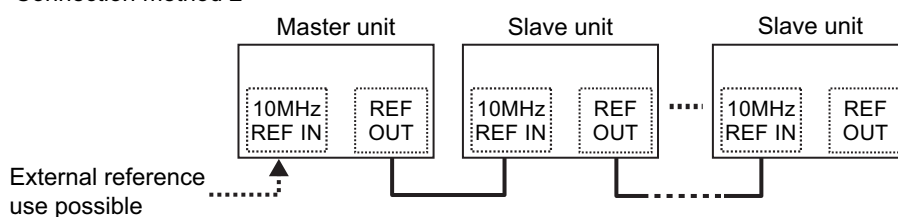

Connection cable

Cable type	Coaxial cable with characteristic impedance of 50 Ω with BNC connector (RG-58A/U, etc.)
Cable length limit	1 m or less between units, total length of 3 m or less
Maximum number of connectable units	Connection method 1: 6 units including master unit Connection method 2: 4 units including master unit
Phase synchronization operation	Manual operation
Time difference between units	Delay of each channel of n th slave unit in relation to each channel of the master unit ($1 \leq N$)
	Connection method 1: $31 \text{ ns} + (N-1) \times 6 \text{ ns} \quad \pm 25 \text{ ns or less typ.}$
	Connection method 2: $31 \text{ ns} + (N-1) \times 31 \text{ ns} \quad \pm 25 \text{ ns or less typ.}$
	Condition: Same frequency, same phase, same waveform (sine or square), length of connection cable between frequency reference output and external frequency reference input = 1 m (RG-58A/U)

7.14 User-Defined Units

Function	Setting and display in arbitrary unit according to the specified conversion expression
Setting target	Frequency (Hz), period (s), amplitude (V_{p-p} , V_{pk}), DC offset (V), phase (deg), duty (%)
Conversion expression	$[(\text{Setting target value}) + n] \times m$, or $[\log_{10}(\text{setting target value}) + n] \times m$ Specification of conversion expression and values of n and m
Unit character string	Up to 4 characters can be set

7.15 Other Functions

Setting saving capacity	10 settings (saved to non-volatile memory)
Remote control	GPIO, USBTMC (SCPI-1999, IEEE-488.2)

7.16 Options

PA-001-1318 multi-I/O cable	Cable with connector on one end, for connection to multi-I/O connector on rear panel. 2 m length. Cut off at one end.
-----------------------------	---

7.17 General Characteristics

Display unit	3.5 inch TFT color LCD
--------------	------------------------

I/O ground

The signal grounds for waveform output (FCTN OUT), sync/sub-output (SYNC/SUB OUT), and external modulation/addition input (MOD/ADD IN) are insulated from the housing. These signal grounds are shared within the same channel.

The signal ground for the external 10 MHz reference input (10 MHz REF IN) is insulated from the housing.

Each of the signal grounds of CH1, CH2, and 10MHz REF IN are independent.

The withstand voltage between insulated signal grounds and between housings is 42 Vpk max. (DC+AC peak)

The other signal grounds are connected to the housing.

Power supply

Power supply voltage range	100 V AC to 230 V AC $\pm 10\%$ (250 V or lower)
----------------------------	--

Power supply frequency range	50 Hz/60 Hz ± 2 Hz
------------------------------	------------------------

Power consumption	WF1973: 50 VA or less WF1974: 75 VA or less
-------------------	--

Overvoltage category	II
----------------------	----

Ambient temperature and humidity ranges

Operation guarantee	0°C to +40°C, 5%RH to 85%RH Absolute humidity of 1 g/m ³ to 25 g/m ³ , no condensation Temperature range limitations apply for some specifications.
---------------------	---

Altitude of 2000 m or less

Storage conditions	-10°C to +50°C, 5%RH to 95%RH Absolute humidity of 1 g/m ³ to 29 g/m ³ , no condensation,
--------------------	--

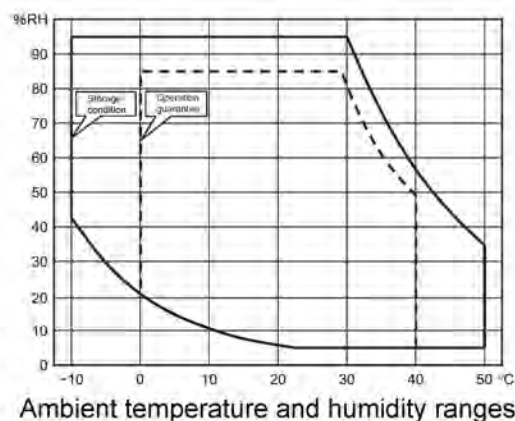

7. SPECIFICATIONS

Warm-up time	30 minutes or more typ.
Pollution degree	2 (indoor use)
External dimensions	216 (W) × 88 (H) × 332 (D) mm (excluding projections)
Weight	Approx. 2.1 kg (excluding accessories, weight of main unit only)
Safety and EMC	
Applied only to models with the CE marking displayed on the rear panel	
Safety	EN 61010-1
EMC	EN 61326-1
RoHS Directive	Directive2011/65/EU

■ External dimensions (WF1973)

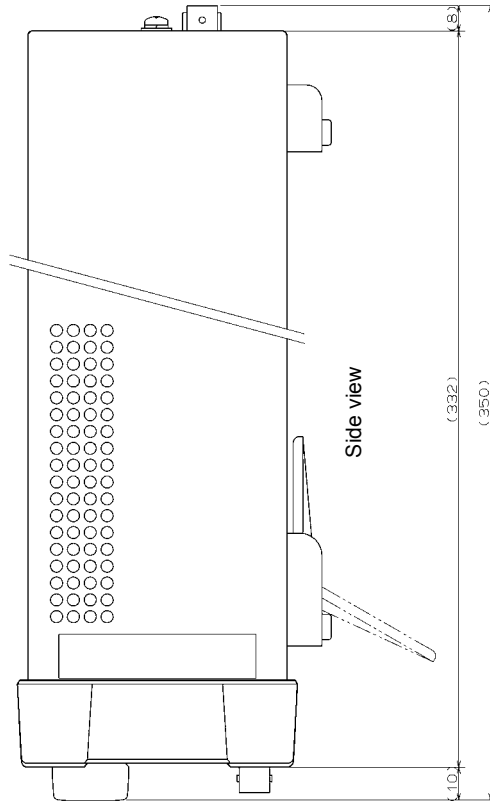

Surface treatment
 Front panel: Plastic ultra-light gray (Munsell 6PB9.2/0.1)
 Rear panel: Munsell 8.5PB2.6/0.2
 Covers: Light gray leather tone (Munsell 6PB7.6/1.2 leather tone)

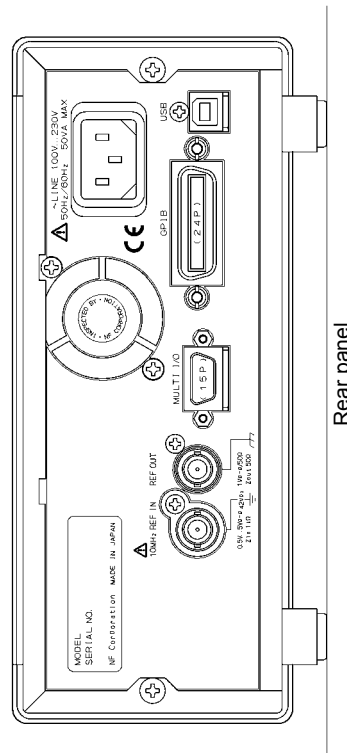
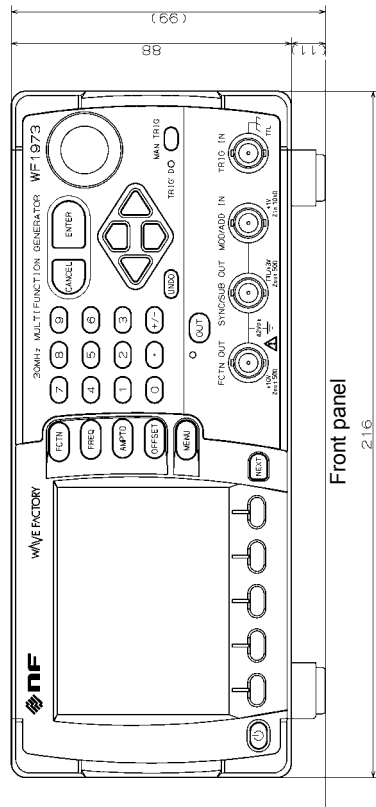

■ External dimensions (WF1974)

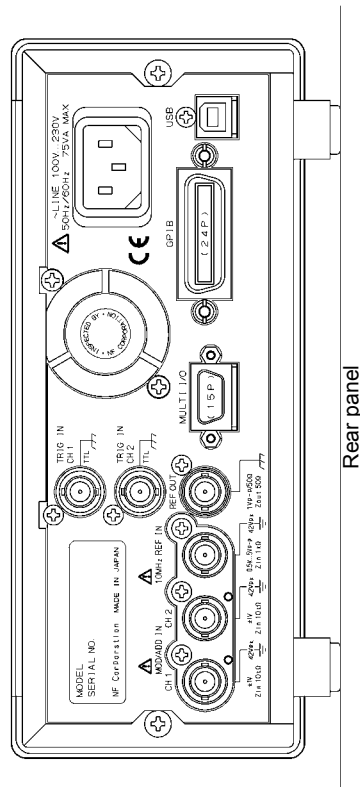
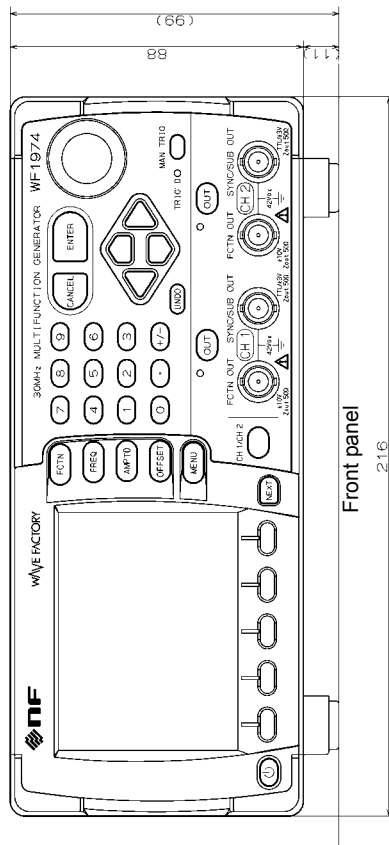
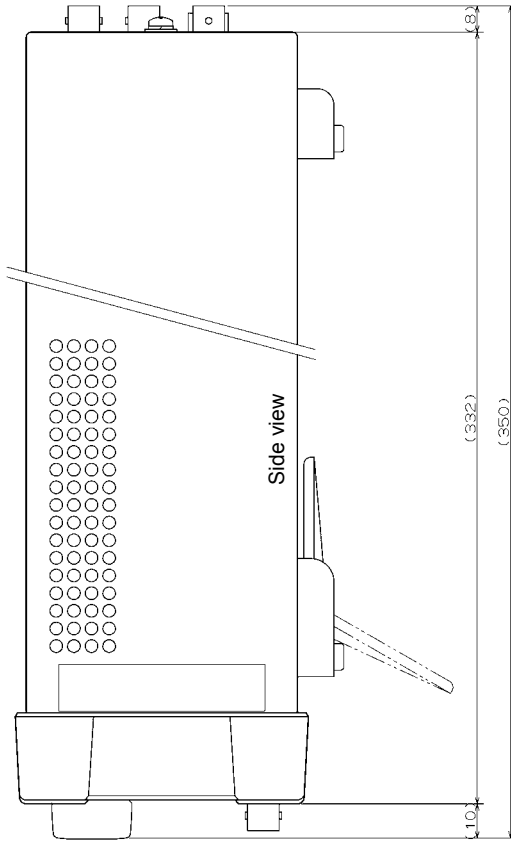

Surface treatment
 Front panel: Plastic ultra-light gray (Munsell 6PB9.2/0.1)
 Rear panel: Munsell 8.5PB2.6/0.2
 Covers: Light gray leather tone (Munsell 6PB7.6/1.2 leather tone)

■ Inch rack mounting dimensions (for 2 units)

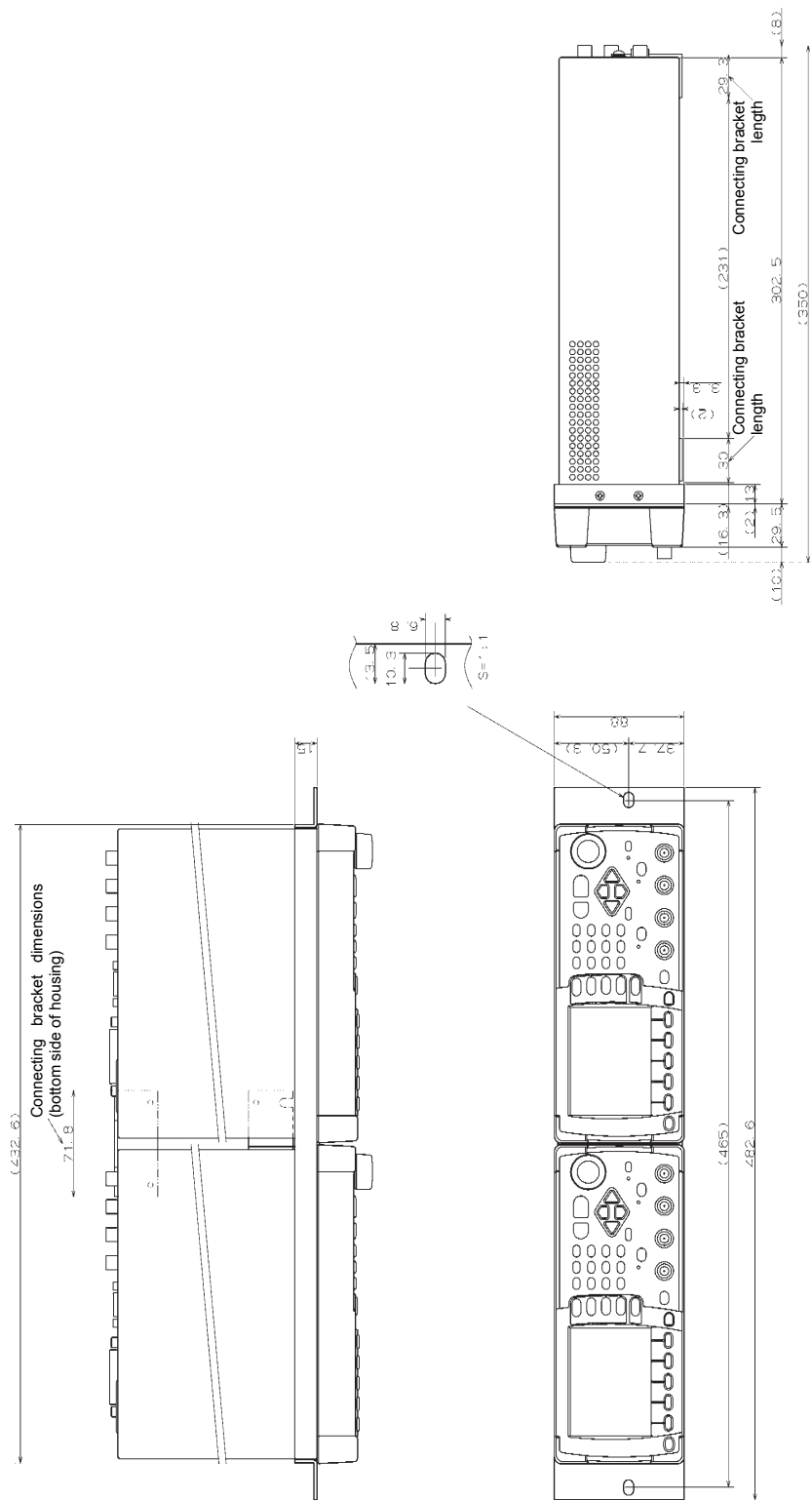

Surface treatment
 Rack mount adapter: Painted in ultra-light gray (Munsell 6PB9.2/0.1)

Caution
 To mount the unit in the rack, do not hold it only with the rack mount adapters. Be sure to use L-brackets or shelves in the rack to hold the main unit. When mounting the unit with shelves, the thickness of the connecting brackets must be taken into consideration.

■ Millimeter rack mounting dimensions (for 1 unit)

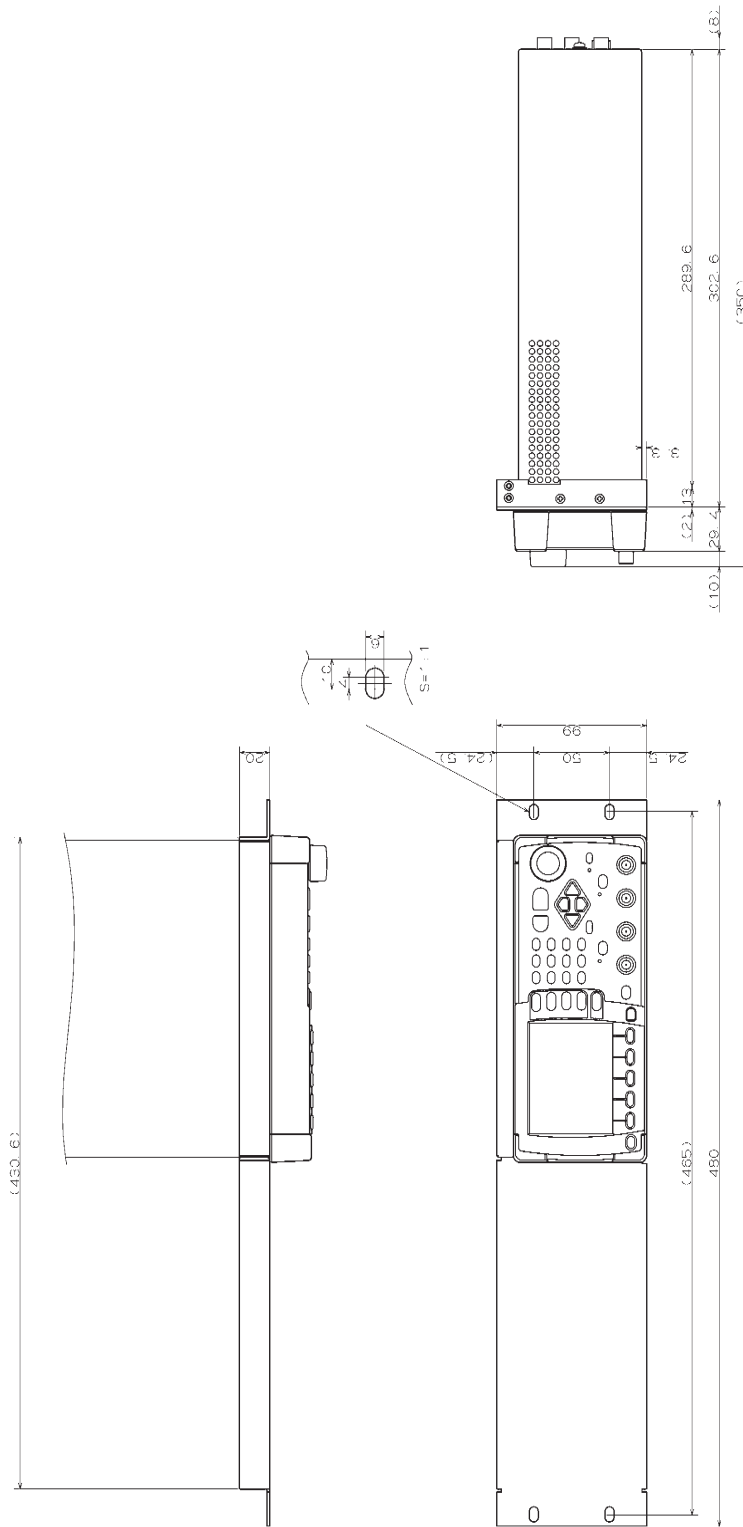

Surface treatment
 Rack mount adapter: Painted in ultra-light gray (Munsell 6PB9.2/0.1)

Caution
 To mount the unit in the rack, do not hold it only with the rack mount adapters. Be sure to use L-brackets or shelves in the rack to hold the main unit.

■ Millimeter rack mounting dimensions (for 2 units)

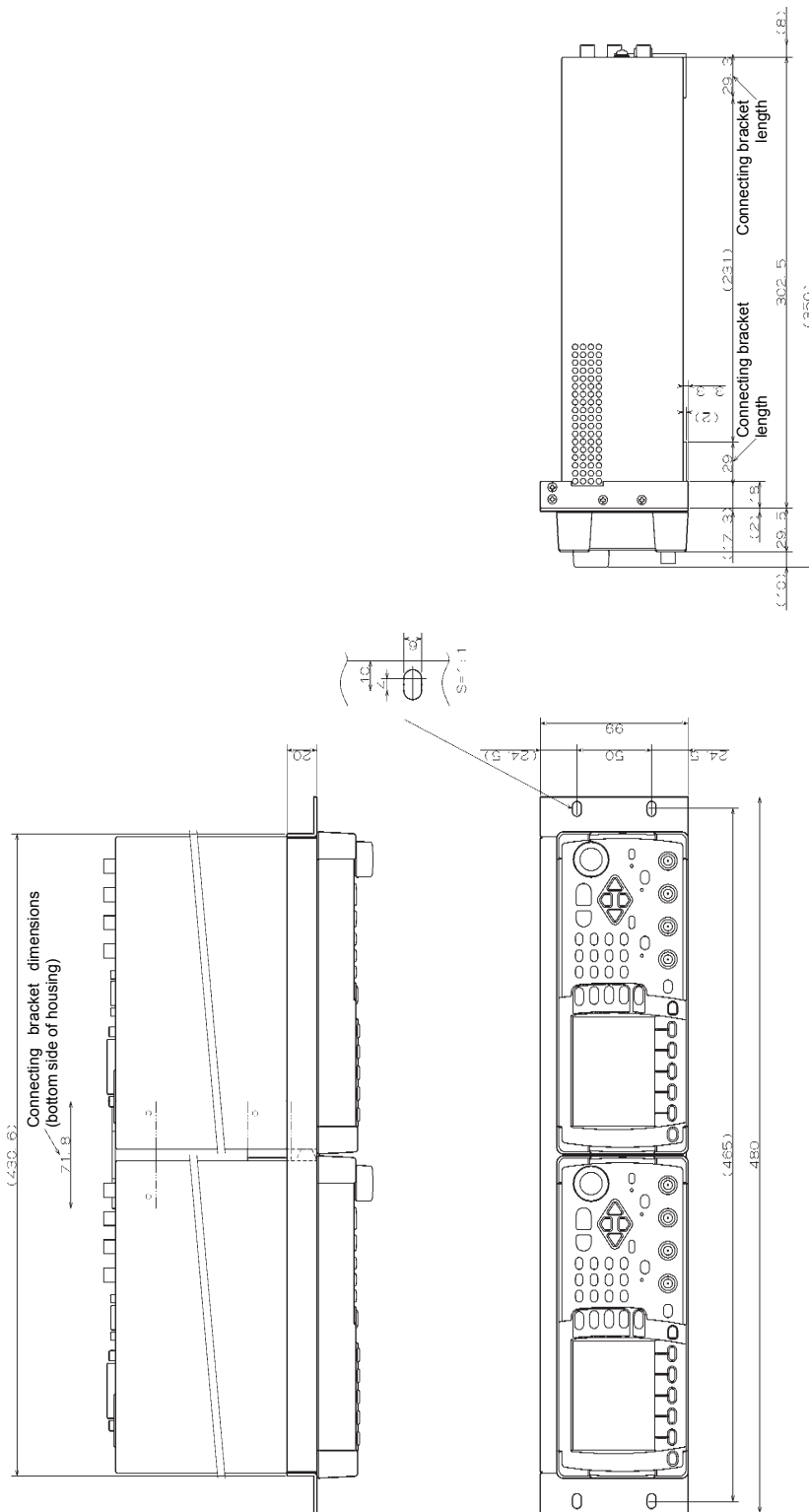

Surface treatment
 Rack mount adapter: Painted in ultra-light gray (Munsell 6PB9.2/0.1)

Caution
 To mount the unit in the rack, do not hold it only with the rack mount adapters. Be sure to use L-brackets or shelves in the rack to hold the main unit. When mounting the unit with shelves, the thickness of the connecting brackets must be taken into consideration.

Index

- 10 MHz REF IN 15
- 42 Vpk IV, 19
- A**
 - AC+DC limitation 49, 50, 51
 - accessories check 4
 - active channel 38
 - adding external signal 57
 - amplitude range 52, 54
 - amplitude setting 48
 - AMPTD key 48
 - application I
 - arbitrary waveforms use 67
 - auto burst 106
 - mark wave number 106, 107
 - space wave number 106, 107
 - start auto burst 108
 - start/stop phase 107
 - stop auto burst 108
 - stop level 108
 - sync output setting 108
 - auto range/range hold 54
- B**
 - Basics I
 - block diagram (WF1973) 2
 - block diagram (WF1974) 3
 - Both 25, 40
 - burst 105
 - auto burst 106
 - burst mode 106, 109, 113, 118
 - gate oscillation 113
 - mode 106, 109, 113, 118
 - trigger burst 109
 - triggered gate oscillation 118
 - types 105
- C**
 - calibration 7
 - CANCEL key 35
 - CH1/CH2 key 38
 - Conflict! 73, 91, 108
- D**
 - dBm 48
 - dBV 48
 - DC offset setting 50
 - display format switching 28
- E**
 - ENTER key 35
 - external dimensions (WF1973) 147
 - external dimensions (WF1974) 148
 - external frequency reference 25, 39
- F**
 - FCTN key 44
 - FCTN OUT 12
 - features 1
 - floating ground connection 19
 - FREQ key 44
 - frequency setting 44
- G**
 - gate oscillation 113
 - manual trigger 115
 - noise gate oscillation 117
 - oscillation in half-cycle units 116
 - start gate oscillation 115
 - start/stop phase 114
 - stop level 116
 - sync signal 115
 - trigger (gate) settings for gate
 - oscillation 115
 - grounding 6
- H**
 - high level/low level setting of output level 51
- I**
 - I/O terminals 12
 - 10 MHz frequency reference input 15
 - external 10 MHz frequency reference input 15
 - external addition input 14
 - external modulation input 14
 - external modulation/addition input 14
 - external trigger input 14
 - frequency reference input 15
 - frequency reference output 16

modulation/addition input	14
multi-I/O	16
sync/sub-output	13
trigger input	14
waveform output	12
initial settings list	126
installation	5
inverted (waveform polarity)	52

L

LINE	6
load impedance setting	55

M

MAN TRIG key	90, 111, 115, 120
MENU key	29
MOD/ADD IN	14
modify knob	30
modulation	69
AM (DSB-SC) setting	80
AM setting	79
carrier condition setting	72
common modulation settings and manipulations	72
DC offset modulation setting	81
FM setting	75
FSK setting	76
modulation sync signal, modulation waveform signal	74
modulation type selecting	72
modulation types	69
modulation waveform signal	74
modulation width setting	72
modulation with an external signal source	73
modulation with arbitrary waveform ...	73
modulation with the internal signal source	72
PM setting	77
PSK setting	78
PWM setting	82
screen for modulation setting and manipulation	70
start modulation	73
stop modulation	73
type	72
MULTI I/O	16

N

NEXT key	26
normal (waveform polarity)	52

numeric input	31
numeric keypad	31

O

OFFSET key	50
operating principles	2
options	5
oscillation mode setting	43
OUT key	41
output on/off	41
overheating	25

P

panel	
front panel of WF1973	8
front panel of WF1974	10
rear panel of WF1973	9
rear panel of WF1974	11
panel and case cleaning	6
parameter-variable waveforms use	65
period display	45
period setting	45
phase difference between channels	47
phase difference setting	47
phase setting	45
polarity	52
power on/off switching method	21
power supply connection	7
pulse wave	61
leading edge time	61
switching the pulse width time and pulse width duty	61
trailing edge time	61
width and leading/trailing edge time setting	61
width, leading edge time, and trailing edge time definitions and limitations	63

R

rack mounting dimensions	149
rack mounting method	6
ramp wave	64
symmetry setting	64
recall procedure setting	124
Ref	25, 39
REF OUT	16
reference phase	46
remote control	I
repacking	5
repair service	157
restoration of settings	22

restoring the initial settings	41
restoring the saved contents to the initial settings	123

S

safety check	4
safety precautions	III
safety-related symbols	IV
saving procedure setting	122
screen configuration	25
screen page swithcing	26
setting memory name changing	123, 125
shortcut keys	34
soft key display	26
specifications	129
square wave	59
difference between normal and extended variable duty range	60
duty and frequency limitations for standard variable duty range	60
duty setting	59
start/stop phase	46
status display area	25
sweep	83
amplitude sweep setting	99
center and span	86
common sweep settings and manipulations	86
continuously repeat	87
DC offset sweep setting	101
duty sweep setting	103
external logic control	94
frequency sweep setting	95
function	86, 87
gated single-shot sweep	89
hold	91
item to be swept selecting	86
manual trigger	90
mode	87, 88, 89
one-way sweep	86
oscillation stop unit	89
output the waveform only during sweep execution	89
pause sweep	91
phase sweep setting	97
rising/falling direction	87
sawtooth wave sweep	86
screen for sweep setting and manipulation	83
shuttle sweep	87
single-shot sweep	88
start sweep	91
start sweep in synchronization with a trigger	88
start value output	91
start/stop phase	89
stop level	89
stop sweep	91
stop value output	92
substitute center value to marker value	94
substitute marker value to center value	94
sweep function	86, 87
sweep marker signal	92
sweep mode	87, 88, 89
sweep range and time	86
sweep type	86
sweep types	83
sweep X drive signal	92
sync signal	92
sync signal, marker signal, X drive signal	92
time	86
triangular wave sweep	87
trigger condition setting	90
type	86
SYNC/SUB OUT	13

T

tabs	27
Temp	25
top menu	29
TRIG IN	14
trigger burst	109
manual trigger	111
mark wave number	109, 110
start trigger burst	111
start/stop phase	110
stop level	112
sync signal	111
trigger delay setting	111
trigger settings for trigger burst	111
triggered gate oscillation	118
manual trigger	120
noise triggered gate oscillation	121
oscillation in half-cycle units	121
start triggered gate oscillation	120
start/stop phase	119
stop level	121

sync signal	120
trigger settings	120
TRIG'D lamp	90, 111, 115, 120

U

UCal	25
uncalibrated	25
UNDO key	35
unit changing	36
unit of amplitude changing	48
user-defined unit	37
Utility screen function	39

V

Vpk	48, 53
Vp-p	48, 53
Vrms	48

W

warranty	157
waste disposal	IV
waveform amplitude range	52
waveform polarity	52
waveform polarity and amplitude range setting	52
waveform setting	44

WARRANTY

NF CORPORATION certifies that this instrument was thoroughly tested and inspected and found to meet its published specifications when it was shipped from our factory.

All **NF** products are warranted against defects in materials and workmanship for a period of one year from the date of shipment. During the warranty period of, **NF** will, at its option, either will repair the defective product without any charge for the parts and labor, or either repair or replace products which prove to be defective. For repair service under warranty, the product must be returned to a service center designated by **NF**. Purchaser shall prepay all shipping cost, duties, and taxes for the product to **NF** from another country, and **NF** shall pay shipping charge to return the product to purchaser.

This warranty shall not apply to any defect, failure or damage caused by improper use, improper or inadequate maintenance and care or modified by purchaser or personnel other than **NF** representatives.

NF CORPORATION

If there are any misplaced or missing pages, we will replace the manual. Contact the sales representative.

NOTES:

- Reproduction of the contents of this manual is forbidden by applicable laws.
 - The contents of this manual may be revised without notice.
 - Information provided in this manual is intended to be accurate and reliable. However, we assume no responsibility for any damage regarding the contents of this manual.
 - We assume no responsibility for influences resulting from the operations in this manual.
-

WF1973/WF1974 Instruction Manual (Basics)

NF CORPORATION

3-20 Tsunashima Higashi 6-chome, Kohoku-ku, Yokohama-shi 223-8508, JAPAN

Phone: 81-45-545-8128 Fax: 81-45-545-8187

<http://www.nfcorp.co.jp/>

© Copyright 2007 - 2022, **NF Corporation**

