



PROGRAMMABLE AC/DC POWER SOURCE

KP3000S

INSTRUCTION MANUAL(Remote Control)

NF Corporation

DA00030863-003

PROGRAMMABLE AC/DC POWER SOURCE

KP3000S

INSTRUCTION MANUAL(Remote Control)

Preface

This instruction manual explains the remote interfaces of the Programmable AC/DC Power Source KP3000S. For operations from the panel, see the instruction manual of the main unit.

The remote interface allows you to use not only the basic KP3000S features (e.g., power source control and measurement function), but also its extensive features (e.g., sequence output and simulation execution control) that cover various details of user needs.

This instruction manual is for the following firmware versions.

Product Name	Firmware Version
Firmware	Ver 1.40 or later
LAN Interface Firmware	Ver 1603.xxx.xxx or later

- This manual consists of the following chapters.

When you use this product for the first time, start with "**1. Preparation before Use.**"

1. Preparation before Use

Explains the setting of the remote interface.

2. Status System

Explains the content of service requests (SRQ) and status bytes.

3. Remote Command Overview

Explains the remote command formats accepted by the KP3000S.

4. Remote Command Reference

Includes the list of KP3000S remote commands and descriptions for each command.

5. Programming Sample

Explains the programming samples for remote-controlling the KP3000S.

6. Error Message List

Includes the list of error messages replied by the KP3000S in response to remote commands.

7. Specifications

Includes the specifications of the remote interface.

Table of Contents

	Page
Preface	i
Table of Contents	ii
List of Figures	iv
List of Tables	v
1. Preparation before Use	1
1.1 Overview	2
1.2 USB Preparation	4
1.3 RS232 Preparation	7
1.4 GPIB Preparation	10
1.5 LAN Preparation	13
1.6 About Remote and Local	26
1.6.1 Remote State	26
1.6.2 Local State	26
1.7 Considerations	27
1.7.1 Considerations Common to the Interfaces	27
1.7.2 USB Interface	28
1.7.3 RS232 Interface	28
1.7.4 GPIB Interface	29
2. Status System	30
2.1 Service Request	31
2.2 Status Byte	32
2.2.1 Status Byte Register and Service Request	32
2.2.2 Status Byte Register	33
2.2.3 Service Request Enable Register	34
2.2.4 Standard Event Status Register Group	34
2.2.5 Operation Status Register Group	35
2.2.6 Warning Condition Register Group	38
2.2.7 System Lock Condition Register Group	40
3. Remote Command Overview	42
3.1 Remote Command	43
3.1.1 Command Type and Format Concept	43
3.1.2 About SCPI	43
3.1.3 Supported Common Command	44
3.1.4 SCPI Command and Query Format	45
3.1.5 SCPI Subsystem Command Tree	45
3.1.6 Elements of SCPI Commands	48
3.1.7 Overview of Response Message Formats	55
4. Remote Command Reference	60

4.1	Program Command List.....	61
4.1.1	List of Commands Common to Functions.....	62
4.1.2	List of Continuous Function Commands.....	64
4.1.3	List of Sequence Function Commands.....	68
4.1.4	List of Simulation Function Commands.....	69
4.2	Program Command Description.....	72
4.2.1	Commands Common to Functions.....	72
4.2.2	Continuous Function Commands.....	104
4.2.3	Sequence Function Commands.....	168
4.2.4	Simulation Function Commands.....	182
5.	Programming Sample.....	229
5.1	KP3000S Control Programming.....	230
5.2	Continuous Function Setting.....	231
5.3	Sequence Function Control.....	234
5.4	Simulation Function Control.....	236
5.5	Obtain Status Register.....	238
5.6	Cautions in Programming.....	240
6.	Error Message List.....	241
6.1	Error Message List.....	242
7.	Specifications.....	245
7.1	Interface Functions.....	246
7.2	GPIB Bus Driver.....	246
7.3	Code Used.....	247
7.4	Response to Interface Message.....	247
7.5	Multi-Line Interface Message.....	248
7.6	List of functions supported by LXI.....	249

Figures and Tables

■ List of Figures

	Page
Figure 2.1 Status Byte Register and Service Request Enable Register	32
Figure 2.2 Standard Event Status Register Group.....	34
Figure 2.3 Operation Status Register Group	35
Figure 2.4 Warning Condition Register Group.....	38
Figure 2.5 System Lock Condition Register Group	40
Figure 3.1 Example of Command Tree.....	45
Figure 3.2 Common Command Syntax.....	48
Figure 3.3 SP Syntax.....	48
Figure 3.4 Subsystem Command Syntax	48
Figure 3.5 Numeric Parameter (<REAL>, <INT>) Syntax	50
Figure 3.6 Mantissa Syntax	51
Figure 3.7 Index Syntax.....	51
Figure 3.8 Discrete Parameter (<DISC>) Syntax	51
Figure 3.9 Boolean Value Parameter (<BOL>) Syntax.....	52
Figure 3.10 String Parameter (<STR>) Syntax.....	52
Figure 3.11 Block Program Data (<BLK>) Syntax	53
Figure 3.12 Suffix Syntax.....	53
Figure 3.13 Program Message Syntax	54
Figure 3.14 Response Message Syntax	55
Figure 3.15 Real Number Response Data (<REAL>) Syntax.....	55
Figure 3.16 NR2 Number Response Data (<NR2>) Syntax	56
Figure 3.17 NR3 Number Response Data (<NR3>) Syntax	56
Figure 3.18 Integer Response Data (<INT>) Syntax	56
Figure 3.19 Discrete Response Data (<DISC>) Syntax	57
Figure 3.20 Numeric Boolean Value Response Data (<NBOL>) Syntax	57
Figure 3.21 String Response Data (<STR>) Syntax.....	57
Figure 3.22 Definite Length Arbitrary Block Response Data Syntax (<DBLK>)	58
Figure 3.23 Indefinite Length Arbitrary Block Response Data Syntax (<IBLK>)	58
Figure 7.1 Multi-Line Interface Message	248

■List of Tables

	Page
Table 2.1 Status Byte Register.....	33
Table 2.2 Standard Event Status Register	34
Table 2.3 Operation Status Register	36
Table 2.4 Transition Filter and Event Register Transitions	37
Table 2.5 Warning Condition Register	39
Table 2.6 System Lock Condition Register	41
Table 3.1 IEEE488.2 Common Commands Supported by KP3000S.....	44
Table 3.2 Acceptable and Unacceptable Keywords (for "OUTPut")	49
Table 6.1 Error Message List	242
Table 7.1 Interface Functions	246
Table 7.2 Bus Driver Specifications	246
Table 7.3 Response to Interface Message	247

1.Preparation before Use

1.1 Overview	2
1.2 USB Preparation	4
1.3 RS232 Preparation	7
1.4 GPIB Preparation	10
1.5 LAN Preparation	13
1.6 About Remote and Local	26
1.7 Considerations	27

1.1 Overview

The KP3000S supports following three types of remote interfaces:

- USB (USB Test and Measurement Class USB488 Subclass, abbreviated to USBTMC hereinafter)
- RS232
- GPIB (available when specified at the order.)
- LAN (available when specified at the order.)

The KP3000S is provided with the USB, RS232, GPIB(available when specified at the order) and LAN (available when specified at the order) remote interfaces and is remote-controllable by a computer or other instruments. By sending remote commands for each function and receiving the data, you can control the function execution and read the internal state such as setting values and error statuses.

Regardless of which communication interface is used, you can create and use a program that uses the Virtual Instrument Software Architecture (VISA) library. If you do not have a license to use VISA library, you need to obtain one (generally, it requires some cost).

Irrespective of differences in interface, each function can be used with the same command from the remote interface. However, some functions are not available in the RS232, GPIB and LAN due to interface-specific restrictions.

[Restrictions in RS232 and GPIB and LAN]

- Status and register acquisition method
Serial poll-based status register acquisition is not available.
For details, see 2.2.
- Handling of termination symbol at command send/receive
The RS232, LAN always requires a termination symbol.
- Binary data handling
Arbitrary waveform data in binary data cannot be sent.
- Remote/Local state transition condition
The RS232, LAN cannot perform the state transition from Remote to Local using the remote command. Only the panel operation can change the state to Local.

Command control specification: IEEE Std. 488.2-1992 compatible

(Some commands are omitted or extended depending on the interface.)

Command format specification: compliant with the SCPI Specification 1990.0 command system

1.2 USB Preparation

USB interface (USB1.1, USBTMC)

Item	Description
ID	Already assigned for each device
Terminator	“LF”

The computer used for control needs a USBTMC class driver installed on it. The USBTMC class driver is included in the hardware and software product of each company that provides the VISA library.

■ Operation procedure

- Press the MENU key to move to the root menu, then select [System]. The system setting window opens.

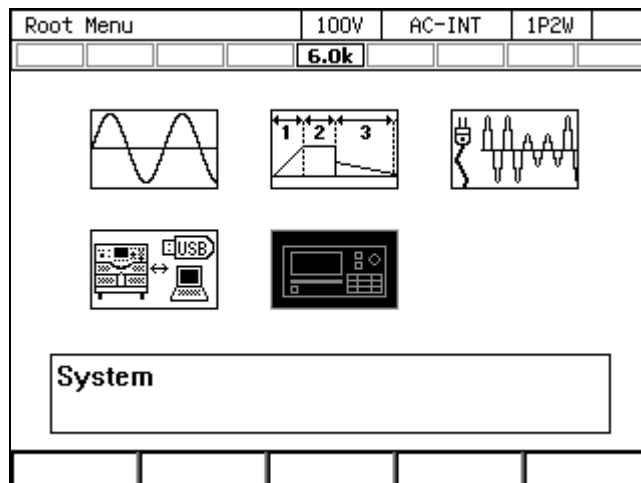

- Put the cursor on [Setup] next to the [Remote] item, then press the ENTER key. The remote setting window opens.

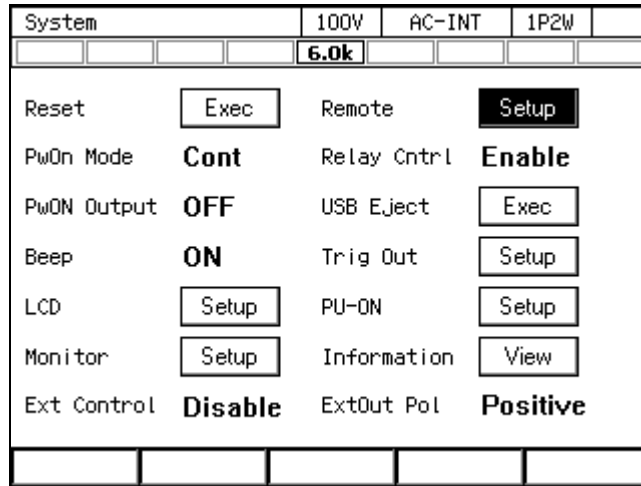

- In the [Interface] item, select [USB].

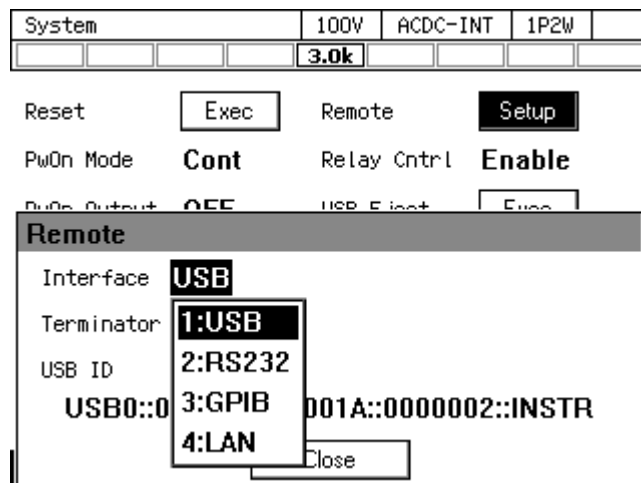

- The window shows [Terminator] and [USB ID]. For the USB ID, see the explanation in the next section. Select [Close] to close the window.

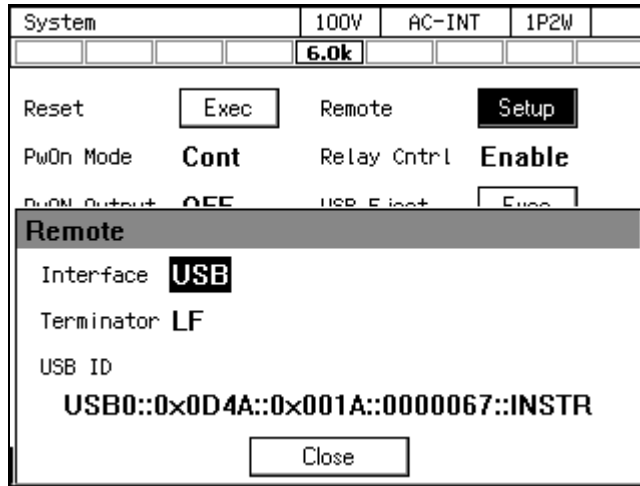

- Use a commercially available USB cable (Type A to B) to connect this product to the computer. USB connector is available on the rear of this product.

--- Notes -----

- Avoid use in a place that has under electrically noisy environment.
- It is recommended to use a fully-shielded, short cable.
- The use of USB hub may cause the product not to communicate properly.

■ About USB ID

Used for a system connected with multiple KP3000S through USB, to enable the application identify each source. The USB ID is represented in the following format.

USB0::[Vendor number]::[Product number]::[Serial number]::INSTR

Vendor number: Fixed to 3402 (0x0D4A)

Product number: Fixed to 33 (0x0021)

Serial number: A unique number (serial number) has been set for each product.

1.3 RS232 Preparation

RS232 interface

Item	Description or Selection	Factory default
Terminal	D-sub 9-pin (male)	
Baud rate	9600 / 19200	9600bps
Terminator	“CR”“LF” / “CR” / “LF”	“CR” “LF”
Parity	None/Odd/Even	None
Stop bit	1 / 2	1 bit
Data bit	7 / 8	8 bit
Flow control	None/Hardware/Software	None

Note: Binary transmission is not supported.

Remote command based arbitrary waveform transmission is not available.

Note: Use a cross cable.

■ Operation procedure

1. Press the MENU key to move to the root menu, then select [System]. The system setting window opens.

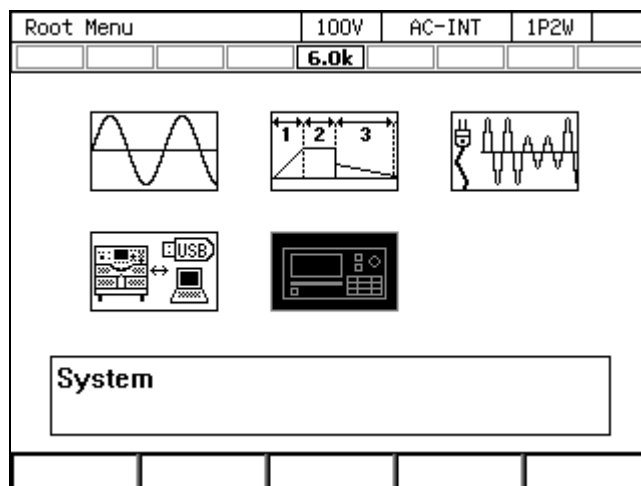

- Put the cursor on [Setup] next to the [Remote] item, then press the ENTER key. The remote setting window opens.

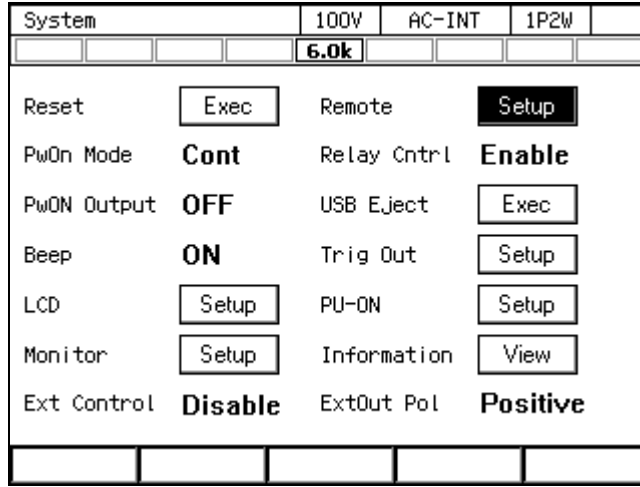

- In the [Interface] item, select [RS232].

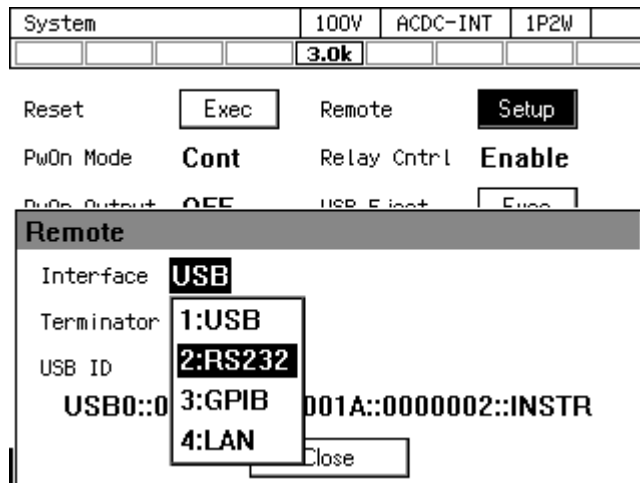

4. Set each item.

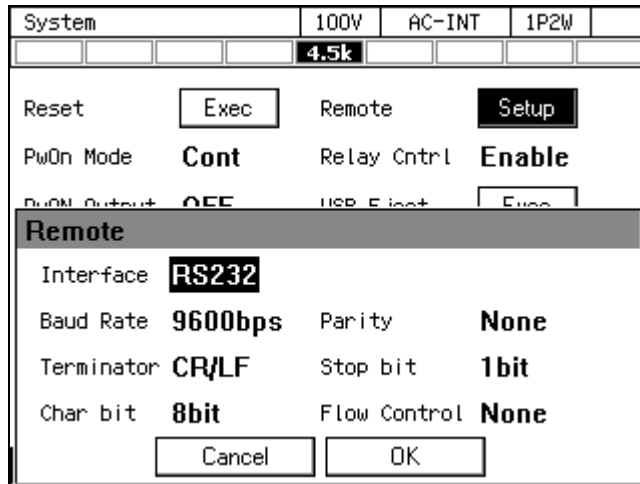

5. Use a D-sub 9-pin cross cable to connect this product to the computer. RS232 connector is available on the rear of this product.

----- Notes -----

- Avoid use in a place that has under electrically noisy environment.
 - It is recommended to use a fully-shielded, short cable.
-

1.4 GPIB Preparation

GPIB interface (specified at the order, IEEE488.1 std 1987 compliant)

Item	Description or Selection	Factory default
Address	0 to 30	2
Terminator	“LF”	

Note: Binary transmission is not supported.

Remote command based arbitrary waveform transmission is not available.

Note: Query for the main unit status byte using a serial poll is not supported.

Mount a GPIB controller board (card) to the controlling computer, then connect between them using a commercially-available GPIB cable. For details, see the instruction manual of your GPIB controller board (card).

■ Operation procedure

1. Press the MENU key to move to the root menu, then select [System]. The system setting window opens.

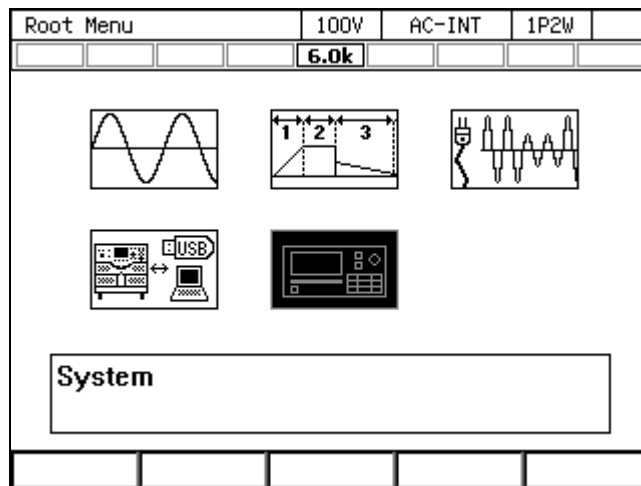

- Put the cursor on [Setup] next to the [Remote] item, then press the ENTER key. The remote setting window opens.

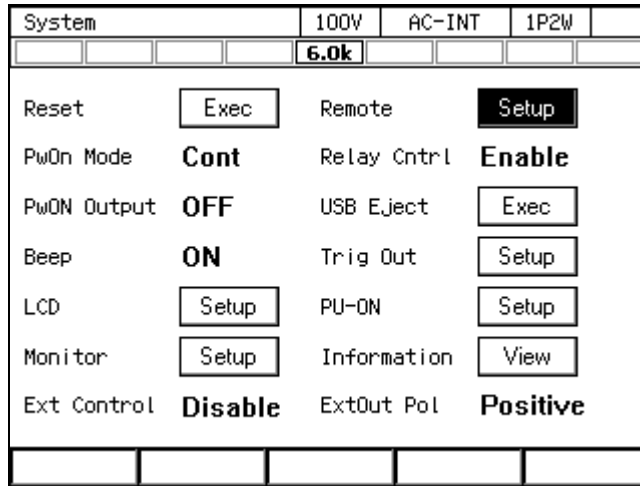

- In the [Interface] item, select [GPIB].

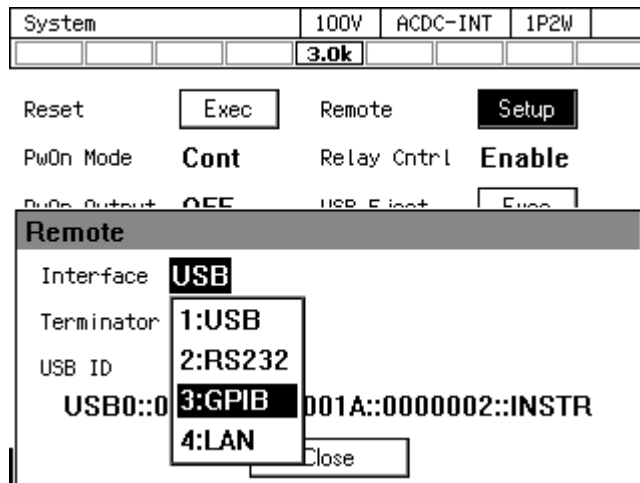

4. In the [Address] item, set the address. [Terminator] is fixed to "LF".

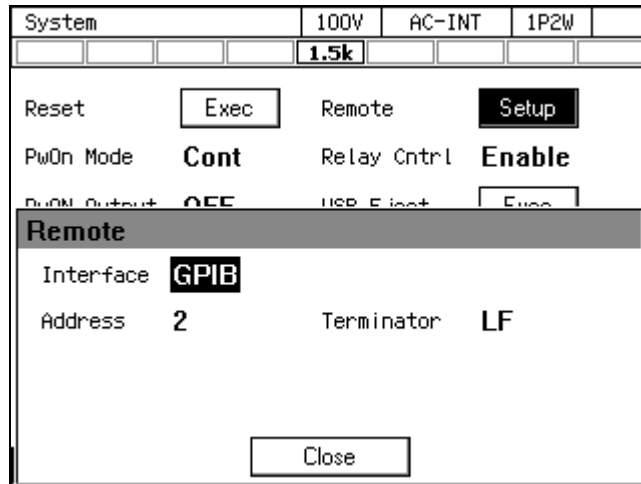

5. Use a GPIB cable to connect this product to the computer. GPIB connector is available on the rear of this product. Turn off this product and the computer before connecting or disconnecting the cable.

----- Notes-----

- Avoid use in a place that has under electrically noisy environment.
 - Before connecting or disconnecting the connector, turn off the power to all devices on the bus.
 - When using the GPIB, turn on the power to all devices on the bus.
 - Ensure that the total cable length is within 20 meters.
 - Ensure that the length of one cable is within 4 meters.
 - Do not set the same address as the one used for any other device connected to the same bus. Otherwise, the product cannot communicate properly.
-

1.5 LAN Preparation

■ LAN interface

(specified at the order, 10BASE-T / 100BASE-TX, AutoMDI/MDI-X, SCPI-RAW : port TCP 5025)

Item	Description or Selection	Note 1	Note 2	Factory default	Note 3
Host Name	If using PC with mDNS function, you can use Host Name instead of IP address.			Product type name	Note 4
Domain	It is not used with this product. Even if you change it, it will not affect the operation.			"1"	
Description	This is the device name displayed when searching using LXI Discovery Tool.			NF Corporation *****_***** (Model Name-Serial No) (Note 5)	
TCP/IP Mode	Auto / Manual Auto : DHCP and Auto-IP function can be used. Manual : The fixed IP address can be used.			Auto	
MAC Address	Already assigned for each device				
IP Address	A	0.0.0.0 - 255.255.255.255		169.254.***.***	("***" shows automatically assigned by the LAN interface.)
	B	169.254.1.0 ~ 169.254.254.255			
	C	Automatically assigned by the DHCP.		Automatically assigned by the DHCP.	
Subnet Mask	A	0.0.0.0 - 255.255.255.255		255.255.0.0	Automatically assigned by the DHCP.
	B	255.255.0.0			
	C	Automatically assigned by the DHCP.			
Default Gateway	A	0.0.0.0 - 255.255.255.255		169.254.***.***	(The same value with the ip address.)
	B	169.254.1.0 ~ 169.254.254.255			
	C	Automatically assigned by the DHCP.		Automatically assigned by the DHCP.	
DNS Server	A	0.0.0.0 - 255.255.255.255		0.0.0.0	Automatically assigned by the DHCP.
	B	0.0.0.0			
	C	Automatically assigned by the DHCP.			
Terminater	"LF"				
Password	Set a password to the configurations of the LAN interface.			no password	

Note 1 : These parameters are set on a web browser. (See section “■Access and operation of this product's website - 3.LAN Configuration”.)

Note 2 : A – C in the table above are the condition of the network connection.

These shows following:

A : When “TCP/IP mode” is “Manual”.

B : When “TCP/IP mode” is “Auto”, and no DHCP server.

C : When “TCP/IP mode” is “Auto”, and a DHCP server is connected.

Note 3 : To restore the factory default settings other than Host Name and Description, push the “Reset” button on the LAN interface attached to the rear panel (See section “■Appearance of LAN interface”). Host Name and Description remain unchanged if entered by the user. If it is not entered, it will be the factory default setting. By setting the selection value to blank, it returns to the factory setting.

Note 4 : When connecting the same type of DP power source to a network, “Host Name” is assigned in the order of recognition by the network.

e.g., if three KP3000Ss are connected in a network, these “Host Name” will be “KP3000S”, “KP3000S-1”, and “KP3000S-2”

Note 5 : When connecting the same type of DP power source to a network, “Host Name” is assigned in the order of recognition by the network.

e.g., if three KP3000Ss are connected in a network, these “Host Name” will be “KP3000S”, “KP3000S(1)”, and “KP3000S(2)”

Note: Binary transmission is not supported.

Remote command based arbitrary waveform transmission is not available.

■ Operation procedure

1. Press the MENU key to move to the root menu, then select [System]. The system setting window opens.

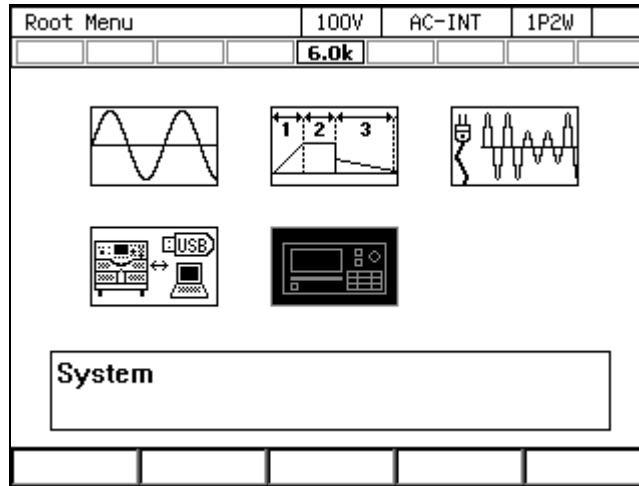

2. Put the cursor on [Setup] next to the [Remote] item, then press the ENTER key. The remote setting window opens.

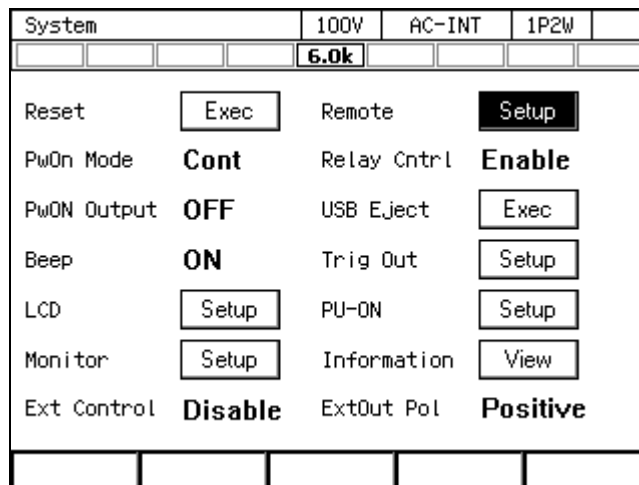

3. In the [Interface] item, select [LAN].

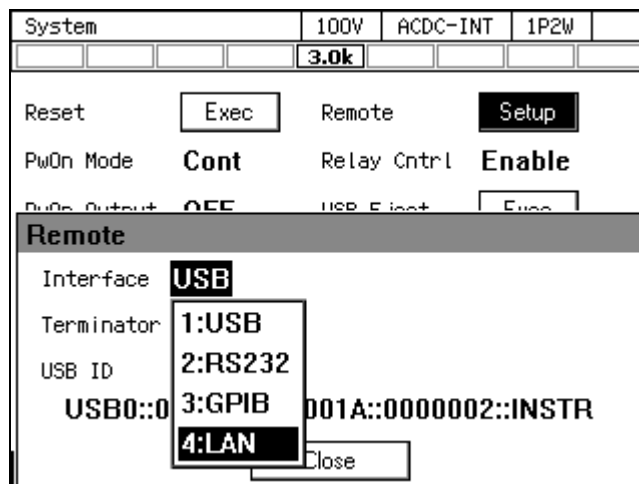

4. The current [MAC Address], [IP Address], [Subnetmask] and [Gateway] are shown. When not using fixed IP, undetermined parameters are shown by “***”. After assignment, these will be updated. About IP address setting, see the section “■Access and operation of this product's website - 3.LAN Configuration”

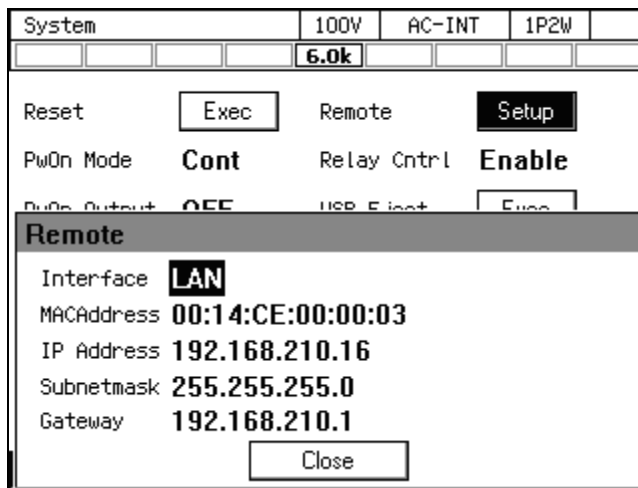
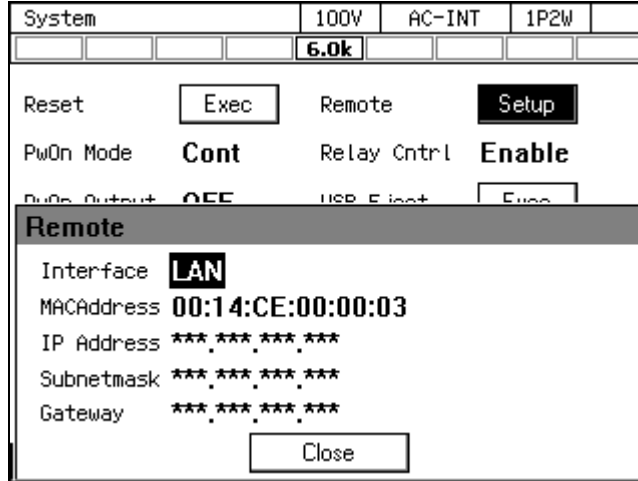

5. Connect this product to a hub or computer with a commercially available LAN cable. LAN connector is available on the rear of this product.

----- Notes -----

- Avoid use in a place that has under electrically noisy environment.

■ Appearance of LAN interface

The LAN interface is available on the rear of this product.

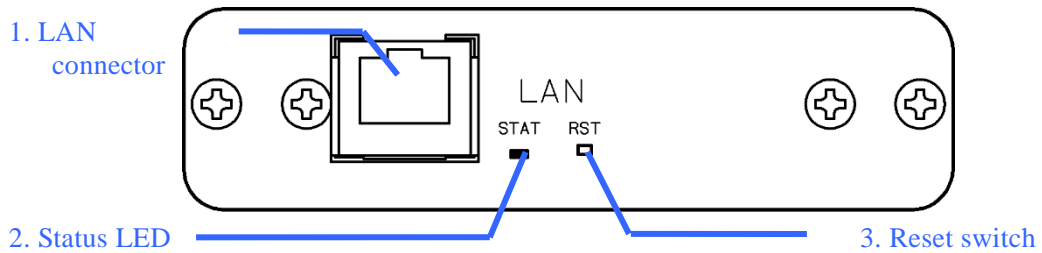

Number	Name	Description
1	LAN connector	LAN cable can be connected.
2	Status LED	Indicates the status of the LAN interface by lighting color and /or blinking.
3	Reset switch	<p>Except for some (Note 1), return LAN interface setting to factory default.</p> <p>■ How to restore</p> <ol style="list-style-type: none"> Following “■ Operation procedure”, select the LAN interface. (Can not restore when other communication interface selected.) Push the switch for about 3 seconds until the LED turns off with a thin tool etc. <p>Note 1 Host Name and Description remain unchanged if entered by the user. Refer to “■LAN interface” for how to return to factory default.</p>

Status LED

Status	Description
Off	Other communication interface is selected.
Red blinking	The LAN interface has some error, and can not communicating. Repeat the procedure of No.1-4 of the section “■Operating procedure”.
Green	The LAN interface completed the preparation to communicate.
Green blinking	Indicates the instrument identification function turn on. About instrument identification, see the next section “■Access and operation of this product's website”.

- Access and operation of this product's website

You can set the configuration of the IP address on the web browser.

----- Notes -----

- Operation verification of the web page of the DP power source was performed on Microsoft® Internet Explorer 11.
-

1. Welcom Page

The main page of the DP power source. You can access this page by entering URL “http://<IP address>/”. In this web page, the basic information and configurations are shown, and you can use the instrument identification function.

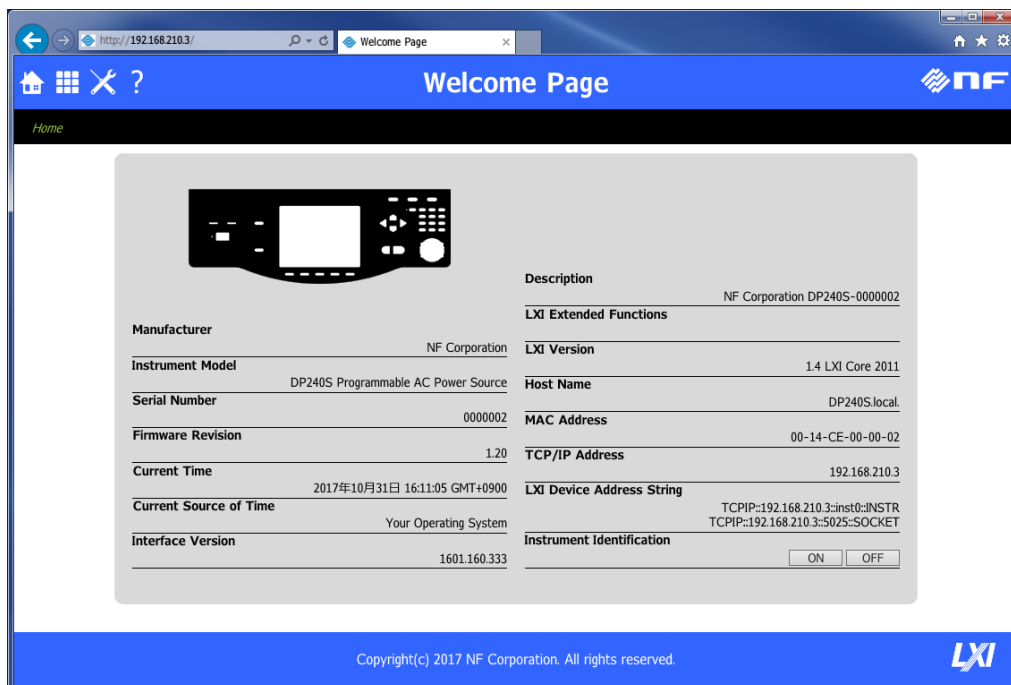

About instrument Identification

If you have more than one instrument connected to the network, you can click the [ON] button to determine which one you are communicating with. When you click [ON] button, Status LED will be blinking green. And you click [OFF] button to stop blinking.

Communicate by “Host Name”

You can use “Host Name” instead of IP address.

When “Host Name” displayed on this page is “KP3000S.local.”, you can access this page by entering URL “http://KP3000S.local./”

2. Remote Control

Click the  icon in the upper left corner of the web page and select Remote Control, the display will change on Remote Control page. On this page you can perform the same operation as the operation panel. Pressing the [Shift] button changes the display of the button as shown on screen 2.

Screen 1

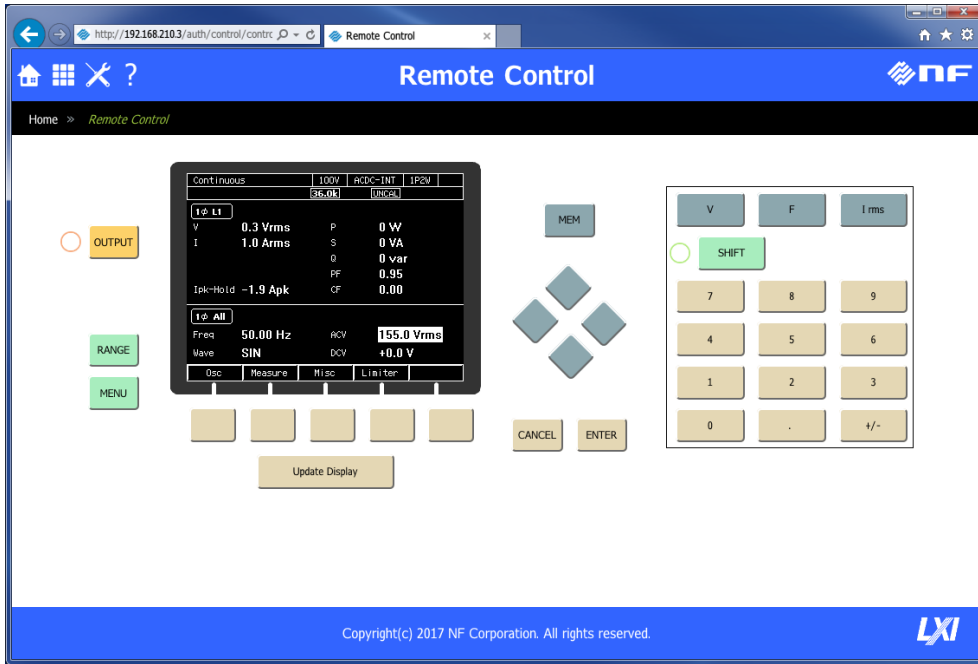

Screen 2

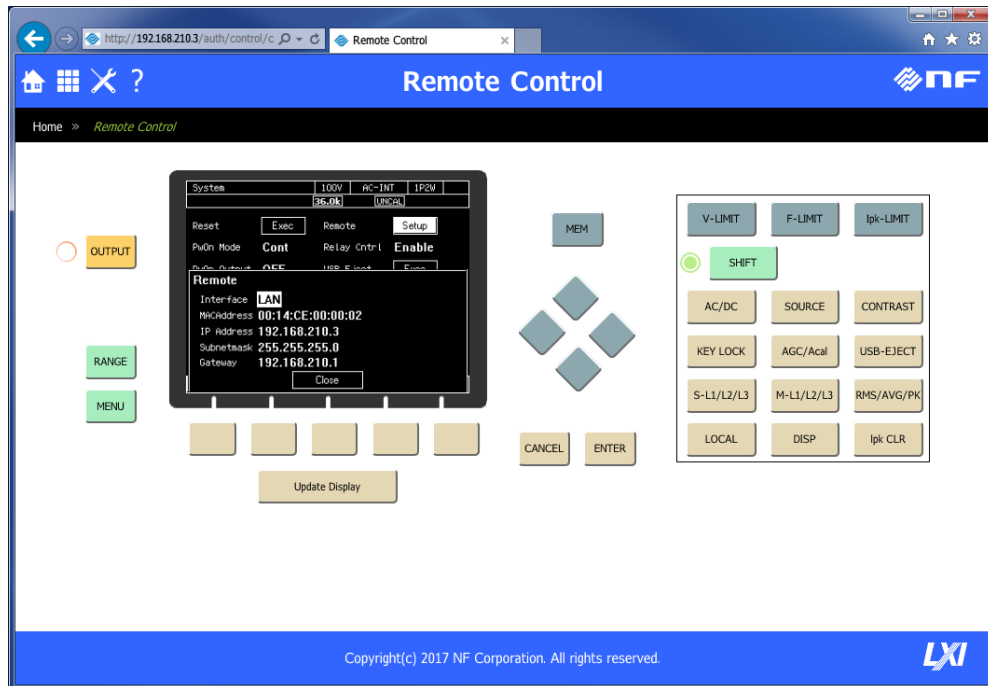

- When the Remote Control screen is displayed for the first time, the LCD screen is not displayed. Please press [Update Display] button to obtain LCD screen.
- Press the "Update Display" button to acquire the current LCD screen.
- When you press the [Shift] button, the shift lamp lights up. When this state (shift state) is reached, screen 2 changes to enable shortcut operation.
- The shift state is held until next pressing the [Shift] button. Therefore, shortcut operation is possible continuously.
- The key operation takes about 2 seconds to respond. Key operation on the Remote Control screen can not be performed while acquiring. Depending on the usage environment, it may take more than 2 seconds.
- Shift lamp and [Shift] button are not synchronized with the operation panel. They are effective only on the Remote Control screen.
- The LCD screen and the OUTPUT lamp display the status acquired when operating on the Remote Control screen (automatic update is not done)
- From the Remote Control screen, you can not switch the IF such as changing from LAN to USB.

3. LAN Configuration

To Enter the LAN Configuration page, click  icon on the upper right of the web page, and select “LAN Configuration”. In this page, you can make settings about LAN connection (e.g., TCP/IP mode).

This product supports both fixed IP address and Auto-IP function (automatic IP address assignment).

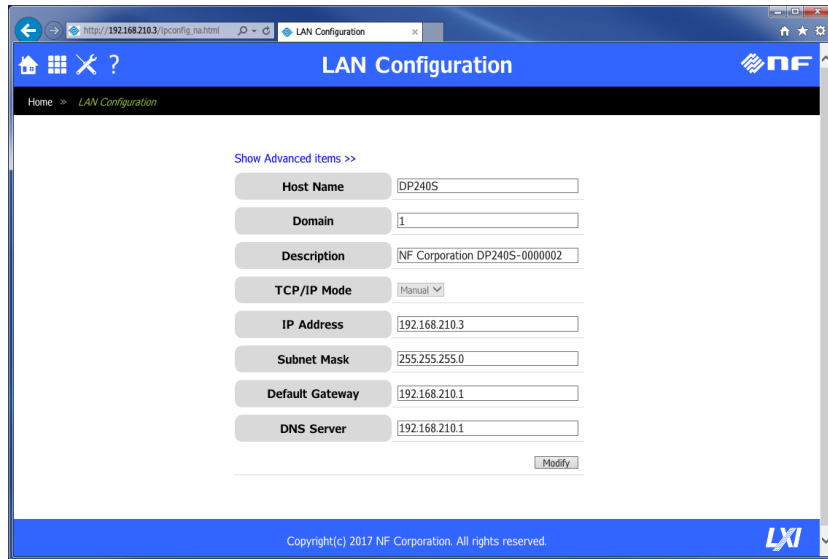

How to set the Fixed IP address

In this section, how to set the fixed IP address is explained (For simplicity, assume that LAN interface is restored to the factory default setting.)

One PC and one LAN cable are required.

1. Change the configuration of “Internet Protocol Version 4” of the PC to “automatic IP address assignment”. (Refer to the PC manual to setup procedure of “automatic IP address assignment”).
2. Connect this product and PC by the LAN cable.
If your PC has some LAN ports, make sure that the other LAN port not to communicate. (e.g., remove LAN cables from the other LAN port.)
3. Following the procedure “■Operation Procedure”, change the remote interface of this product to the LAN interface, and get the IP address.
4. Input URL “http://<IP address>/” on the web browser, and access “Welcome Page” of the LAN interface.

5. Click  icon on the upper right of the web page, and select “LAN Configuration”.
“LAN Configuration” page will be displayed.

6. Click [Modify] button, the parameters displayed in the page can be edited.

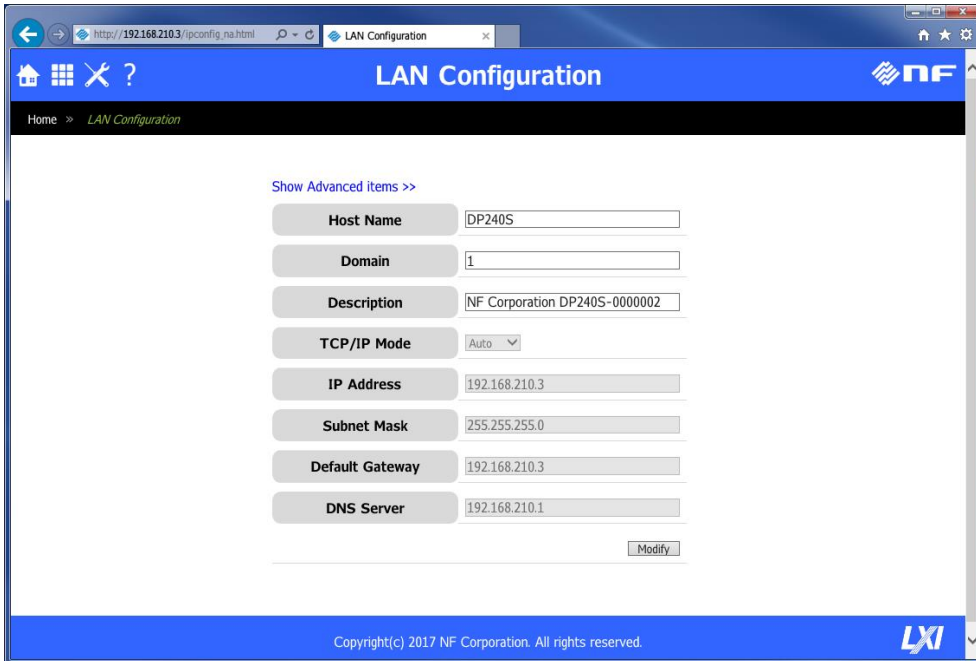

The screenshot shows the LAN Configuration page in a web browser. The page title is "LAN Configuration". Below the title, there is a "Show Advanced items >>" link. The form contains the following fields:

Host Name	DP240S
Domain	1
Description	NF Corporation DP240S-0000002
TCP/IP Mode	Auto
IP Address	192.168.210.3
Subnet Mask	255.255.255.0
Default Gateway	192.168.210.3
DNS Server	192.168.210.1

At the bottom right of the form, there is a "Modify" button. The footer of the page contains the text "Copyright(c) 2017 NF Corporation. All rights reserved." and the LXI logo.

7. Change the parameter [TCP/IP mode] to “Manual”, then the other parameters on this page will be enabled to edit. Set appropriate values to these parameters according to your network, and Click [Submit] Button.

You can communicate to this product by using “Host Name + .local.” instead of the IP address if you set [Host Name] parameter..

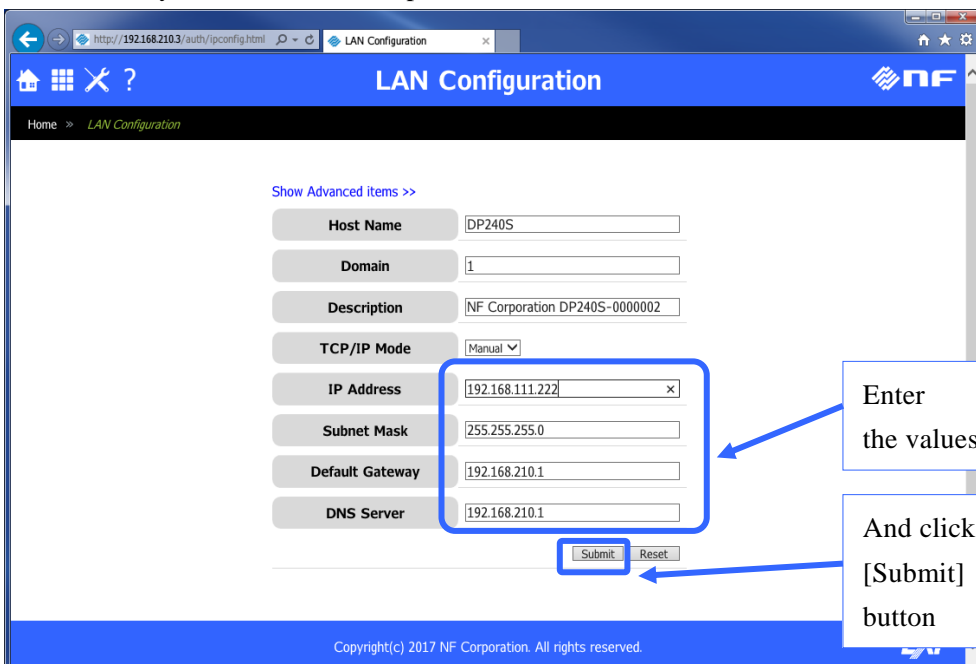

The screenshot shows the LAN Configuration page with the "TCP/IP Mode" set to "Manual". The form fields are now enabled for editing. The IP Address field is highlighted with a blue box and contains the value "192.168.111.222". The "Submit" button is also highlighted with a blue box. Two callout boxes with arrows point to these elements:

- One box says "Enter the values" and points to the IP Address field.
- Another box says "And click [Submit] button" and points to the Submit button.

The footer of the page contains the text "Copyright(c) 2017 NF Corporation. All rights reserved." and the LXI logo.

8. When settings are accepted, following dialog will be displayed. Close this dialog and web browser. (Because the IP address will be changed.)

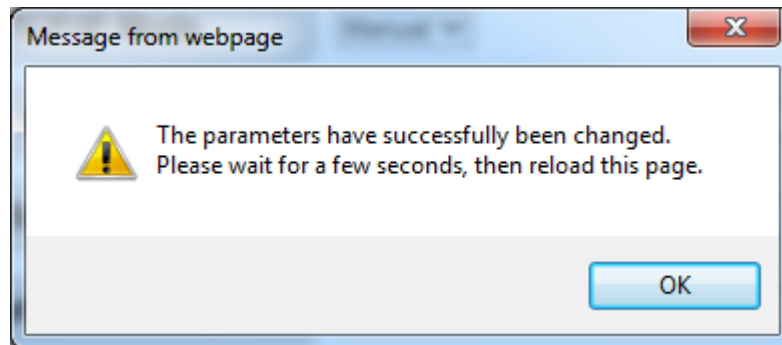

9. Change the configuration of “Internet Protocol Version 4” of the PC to the setting can communicate with this product. (Refer to the PC manual to setup procedure of “automatic IP address assignment”).
10. Launch the web browser again. Input the IP address you set to the URL field, and access “Welcome Page” of the LAN interface. Confirm that “TCP/IP address” value of “Welcome Page” is the same you set. If they are the same, Fixed IP address assignment is completed.

Reset the IP address setting of the PC.

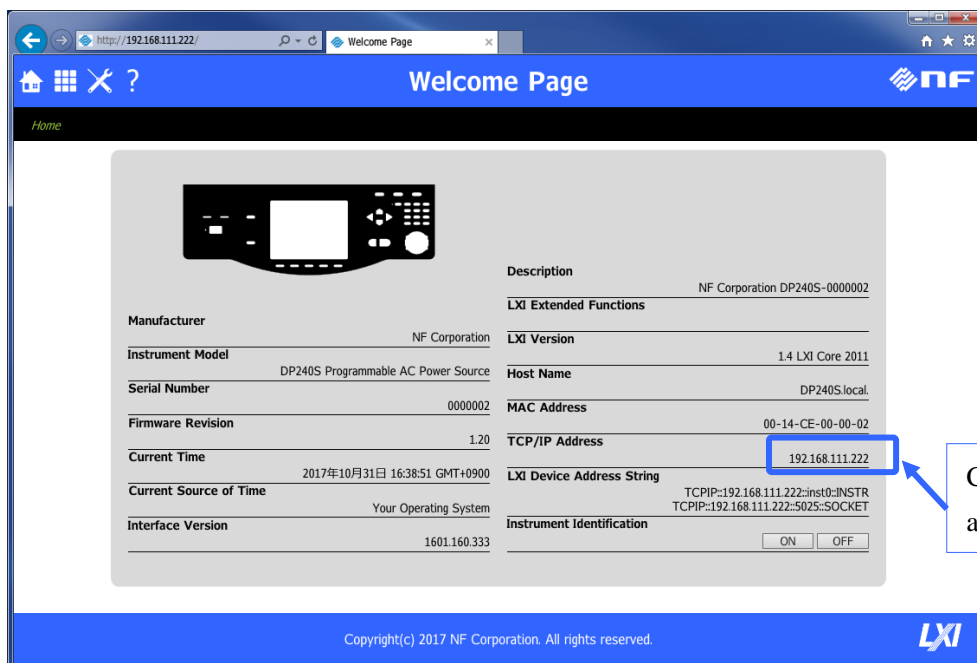

----- Notes -----

- In the case you do not know current IP address of the LAN interface, try the one of following procedure:
 1. Getting current IP address by doing the procedure 1 - 3 of “How to set the Fixed IP address”
 2. Reset the LAN interface by pushing the “Reset Switch”
(Refer to “■Appearance of LAN interface” about “Reset Switch”.)
- In the case the IP address of the other device connected to a network later is duplicated with this product, following two procedures required to solve.
 1. Change the IP address of the other device to avoid the duplication.
 2. Referring to the procedure “■Operation Procedure”, set the remote interface of this product to the other one (e.g., USB), and return to the LAN interface again. (By this procedure, the LAN interface is restart.)

How to enable the automatic IP address assignment.

This product supports the DHCP client function. If enable the automatic IP address assignment, you can connect this product to the network with a DHCP server.

You can set this product to the automatic IP address assignment by setting “TCP/IP mode” parameter to “Auto”. (“TCP/IP Mode” parameter can be edit on the “LAN Configuration” page of the LAN interface web page)

In the case that the LAN interface configurations can be reset to the Factory Default setting, you can connect this product to your network without any change. (Because default setting of “TCP/IP Mode” parameter is “Auto”)

If the LAN interface configurations are changed from the Factory Default setting, try the one of following procedure:

1. Do the procedure 1 - 7 of “How to set the Fixed IP address” and change “TCP/IP Mode” parameter to “Auto”.
2. Reset the LAN interface by pushing the “Reset Switch”
(Refer to “■Appearance of LAN interface” about “Reset Switch”.)

4. Security

To Enter the Security page, click  icon on the upper right of the web page, and select “Security”. In this page, you can create a password of the LAN interface configurations. If you set a password, you will need to enter the password when changing the settings of the “LAN Configuration” page and Security page.

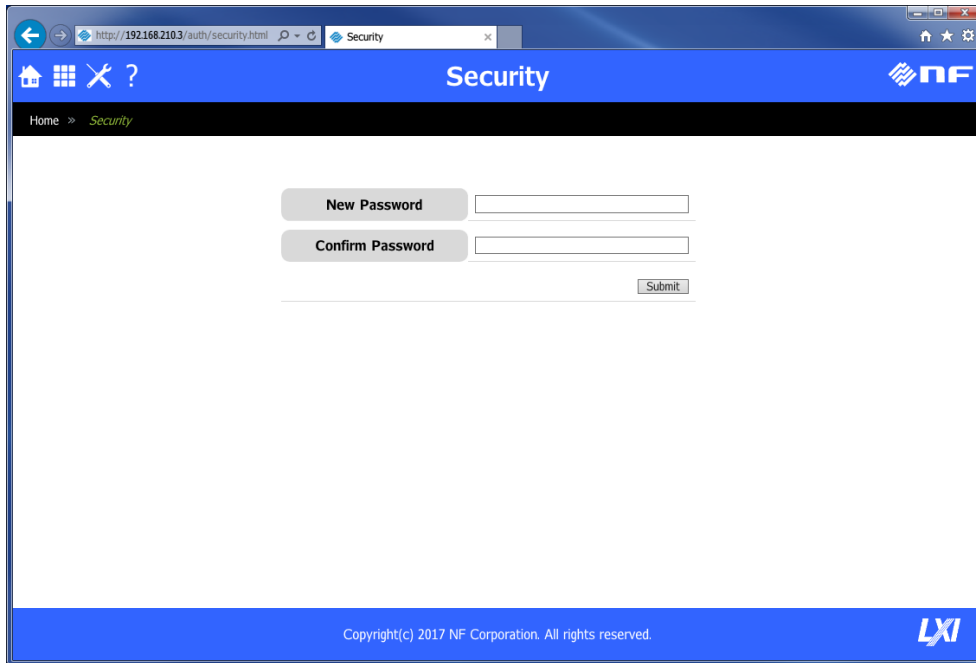

Once set a password, a password input request dialog is shown when you open “LAN Configuration” and “Security” page. You need to enter user name and the password in this dialog.



user name ; “user” (fixed value)

password : the password you set.



1.6 About Remote and Local

1.6.1 Remote State

In the Remote state, the control panel key operations are not accepted. However, the output off (OUTPUT key) and the switching to the Local state ( + ) are available.

- Switching to the Remote state

When communication is established after the command is sent from the computer to the product, the KP3000S switches to the Remote state.

1.6.2 Local State

Control panel key operations are accepted.

- Switching to the Local state

The Shortcut operation ( + ) switches the state to Local.

The Remote state is cleared when the LOCAL key is pressed in the Remote state, when the GPIB bus REN line is set to False (High) from the computer, or when the GTL command is received. However, the LOCAL key is disabled when the KP3000S is in the local lockout state. To clear the local lockout status, you need to set the GPIB bus REN line to False (High) on the computer.

1.7 Considerations

1.7.1 Considerations Common to the Interfaces

- The input buffer size is 2048 bytes.

The KP3000S interprets and executes the commands sequentially as it stores received commands to the input buffer. It can also handle a data of more than the size of the input buffer, where the data includes one statement which consists of multiple commands concatenated together and is terminated with the message terminator (delimiter symbol or EOI). However, the input buffer becomes full if the communication data volume is too large compared to the speed of command interpretation and execution. In that case, the computer cannot send any command, and therefore results in transmission timeout.

Note that the transmission timeout does not occur if the communication is taking place with the RS232 flow control set to None. However, other error occurs such as command execution error because the command sent from the computer is not received correctly by the KP3000S.

If there is an error during interpretation or execution of any one of the multiple commands that are concatenated and sent to the KP3000S, any commands after that command up to the message terminator are discarded; not interpreted or executed.

- The output buffer size is 2048 bytes.

The output buffer is cleared if the size of the response data in reply to the query command from the computer exceeds the output buffer size. At this time, the KP3000S sets the query error bit of the standard event status register to 1.

During the processing of data that includes multiple commands concatenated up to the message terminator (delimiter symbol or EOI) in one statement, if the size of the response data exceeds the output buffer size, the command parsing and execution is continued while the excess response data does not remain in the output buffer.

- The maximum number of errors that can be queued is 16.

Every time a command parsing and execution error occurs, the error message is queued in the error queue. If command errors occur beyond the maximum queuing number of errors, the error message stored in the 16th queue is replaced with "-350,"Queue overflow."

- The USB, RS232, GPIB and LAN interfaces are expected to be used under a relatively stable environment. Avoid using in a place that has power fluctuation or environment with much electrical noise.

----- Restrictions -----

- Do not insert or remove a USB memory while the main unit is performing the remote communication. This may damage the USB memory or cause the main unit to malfunction.

Insert or remove a USB memory after terminating the remote command based auto-execution program and similar activities.

1.7.2 USB Interface

- To use a USB interface, USBTMC device driver software needs to be installed on your computer.
- Not that not all USBTMC device driver software pieces provided by every company have been tested for operation verification.

Operation verification was performed on our USBTMC compatible device driver software (dedicated to the optional application) and the USBTMC device driver software that comes with NI-VISA provided by National Instruments.

1.7.3 RS232 Interface

- One RS232 port cannot have multiple devices connected at one time.
- When communication is taking place with no flow control, the command may not be executed properly. Use the flow control whenever possible.
- For communication that has the hardware flow control enabled, use a cable in which the RTS signal and CTS signal lines are interlink-connected. Use the one that RTS on the computer side is connected to CTS on the KP3000S, CTS to RTS.
- To avoid malfunctioning due to radiated electromagnetic noise, ensure to use a shielded cable.

1.7.4 GPIB Interface

- Power off all devices on the bus when you connect or disconnect the GPIB cable.

- When using the GPIB, turn on the power to all devices connected to the bus.

- Up to 15 devices (including the controller) can be connected to the GPIB in one system.
The cable length has the following limitations.
 - Total cable length is 2 meters x (number of devices) or 20 meters, whichever the shorter
 - Length of a cable is 4 meters or less

- Check carefully for the GPIB address before setting it. Using a duplicated address in one system may damage devices.

- Inconsistency of the delimiter settings in the system might cause unexpected trouble. Use the same delimiter setting for every device that exists in the system.

2. Status System

2.1 Service Request	31
2.2 Status Byte	32

2.1 Service Request

The USB interface supports the service request functions offered by USBTMC.

You can obtain the status of the KP3000S product by performing a serial poll (reading status byte) from your computer, under the conditions shown below. The serial poll allows you to obtain the status of the KP3000S product regardless of the Remote/Local state.

- When the output data for query is prepared
- When some error or warning occurs

The GPIB interface does not support the service request through the SRQ signal line of the bus.

2.2 Status Byte

The status byte can be obtained by a serial poll only when using a USB interface. When using a RS232 or GPIB or LAN interface, the status byte cannot be obtained by a serial poll.

2.2.1 Status Byte Register and Service Request

The configuration of the status byte register and the service request enable register is shown in Figure 2.1.

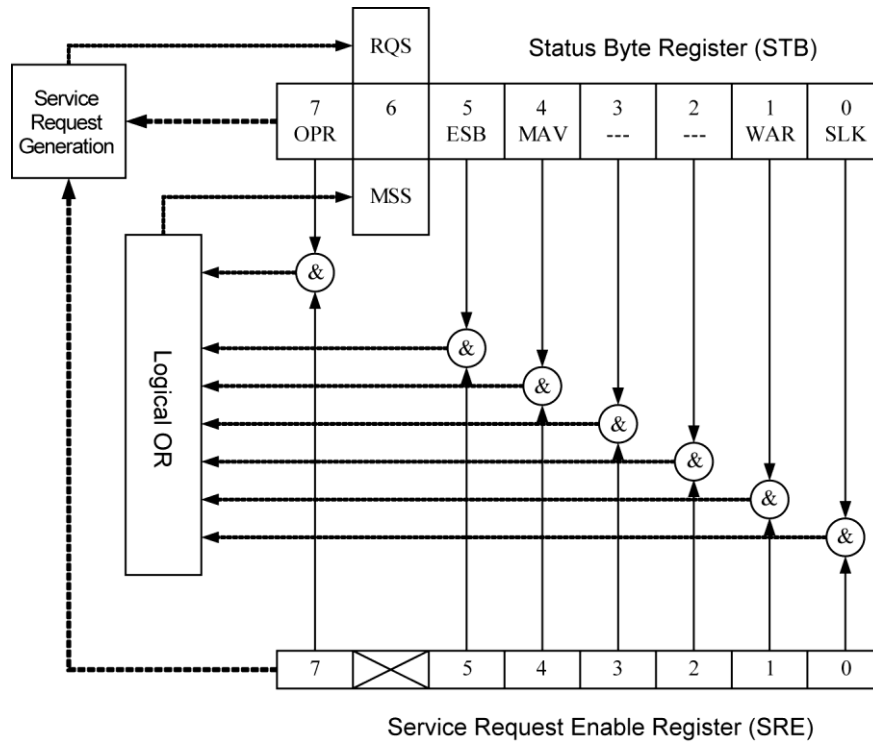

Figure 2.1 Status Byte Register and Service Request Enable Register

2.2.2 Status Byte Register

Each bit of the status byte register is described in Table 2.1.

Table 2.1 Status Byte Register

Bit	Weight	Symbol	Description	Set Condition (set to 1)	Clear Condition (set to 0)
(MSB) 7	128	OPR	Operation condition register summary	This bit is set when the logical OR of bits of the operation event register is 1.	This bit is cleared when the logical OR of bits of the operation event register is 0.
6	64	RQS/ MSS	Request service/master summary status	Note 3	Note 1
5	32	ESB	Standard Event Status Register Summary	This bit is set when the logical OR of bits of the standard event status register is 1.	This bit is cleared when the logical OR of bits of the standard event status register is 0.
4	16	MAV	This bit notifies that the output data for the query is prepared.	This bit is set when the output data for the query is prepared.	This bit is cleared when there is no output data for the query. Note 4
3	8	Unused	Unused	Note 2	Note 2
2	4	Reserved	Reserved	Reserved	Reserved
1	2	WAR	Warning condition register summary	This bit is set when the logical OR of bits of the warning event register is 1.	This bit is cleared when the logical OR of bits of the warning event register is 0.
(LSB) 0	1	SLK	System Lock condition register summary	This bit is set when the logical OR of bits of the System Lock event register is 1.	This bit is cleared when the logical OR of bits of the System Lock event register is 0.

Note 1 : • When a device clear (DCL or SDC) is received.
• After reading the status byte (reading the status byte by a serial poll during the SRQ output or a query message).

Note 2 : • Always 0 because this bit is not used.

Note 3 : • In case of reading by a serial poll, this bit is set when the SRQ is sent.
• In case of reading by a query message, this bit is set if the logical OR of bits of the status byte is 1.

Note 4 : • When a device clear (DCL or SDC) is received.
• USB : After reading the status byte by using a query message.
When using USB, this bit is not cleared by a serial poll.

The status byte register is cleared when a *CLS command is received.

2.2.3 Service Request Enable Register

The service request enable register is used to select the summary bit within the status byte register that generates service requests shown in Figure 2.1.

2.2.4 Standard Event Status Register Group

The configuration of the standard event status register group is shown in Figure 2.2.

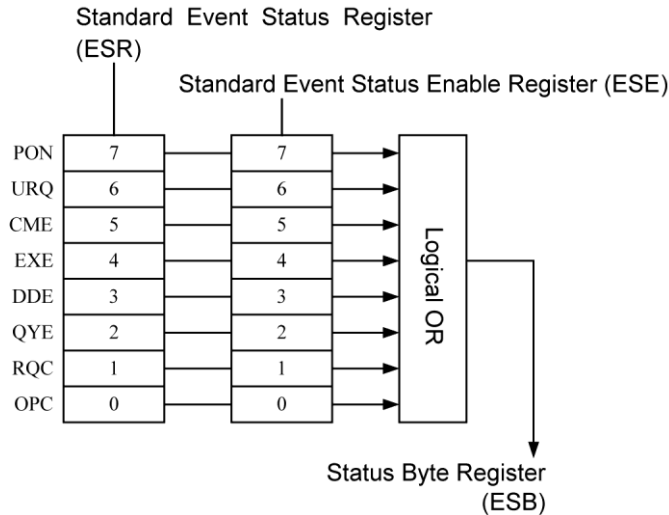

Figure 2.2 Standard Event Status Register Group

2.2.4.1 Standard Event Status Register

Each bit of the standard event status register is described in Table 2.2.

Table 2.2 Standard Event Status Register

Bit	Weight	Symbol	Description
7	128	PON	Power on
6	64	URQ	User request
5	32	CME	Command error
4	16	EXE	Execution error
3	8	DDE	Equipment-specific error (always 0 in the KP3000S)
2	4	QYE	Query error
1	2	RQC	Request control
0	1	OPC	Operation completion

The standard event status register is cleared when the *ESR? query or *CLS command is received.

2.2.4.2 Standard Event Status Enable Register

The standard event status enable register is used to select the bit of the standard event status register as shown in Figure 2.2, and reflect the status of the selected bit to the ESB of the status byte register.

2.2.5 Operation Status Register Group

The configuration of operation status register group is shown in Figure 2.3.

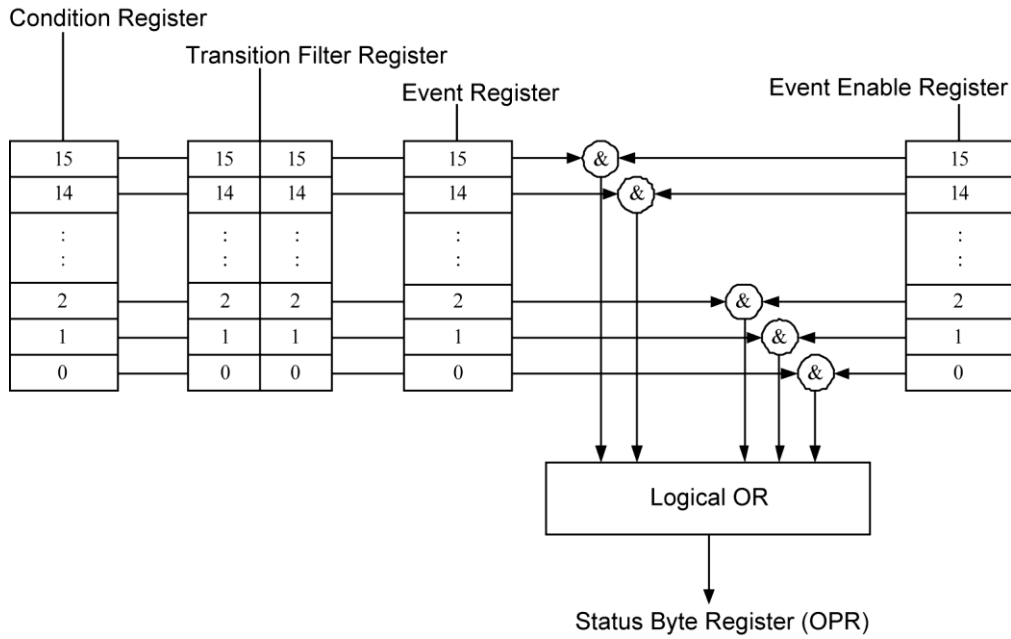

Figure 2.3 Operation Status Register Group

2.2.5.1 Operation Status Condition Register

The operation status condition register is a register that represents the current status of the device. This register is not cleared even when a query addressed to the condition register is received. Each bit of operation status register group is described in Table 2.3.

Table 2.3 Operation Status Register

Bit	Weight	Description
15	-	Always 0
14	16384	Sequence or Simulation is in the Run status
13	-	(Unused)
12	4096	Sequence is in the Hold status
11	-	(Unused)
10	-	(Unused)
9	-	(Unused)
8	256	LOCK status (SYNC status)
7	-	(Unused)
6	-	(Unused)
5	-	(Unused)
4	-	(Unused)
3	-	(Unused)
2	-	(Unused)
1	2	Busy status
0	-	(Unused)

2.2.5.2 Operation Status Transition Filter

The operation status transition filter is a filter for determining the event bit transition.

The operation status transition filter is not cleared even when the *CLS command is received.

The relationship between the transition filter setting and the event register transitions is shown in Table 2.4.

Table 2.4 Transition Filter and Event Register Transitions

Each Bit Setting of Positive Transition Filter	Each Bit Setting of Negative Transition Filter	Transition of Condition Register to Set the Bit of Event Register to 1
0	0	Not changed
0	1	1 → 0 (detects the falling)
1	0	0 → 1 (detects the rising)
1	1	0 → 1 or 1 → 0

2.2.5.3 Operation Status Event Register

The operation status event register is a register that reflects the changes of the condition register according to the transition filter setting.

The event register is cleared upon reception of a query addressed to the event register or the *CLS command.

2.2.5.4 Operation Status Event Enable Register

The operation status event enable register is used to select bits in the event register to be summarized.

2.2.6 Warning Condition Register Group

The configuration of the warning condition register group is shown in Figure 2.4.

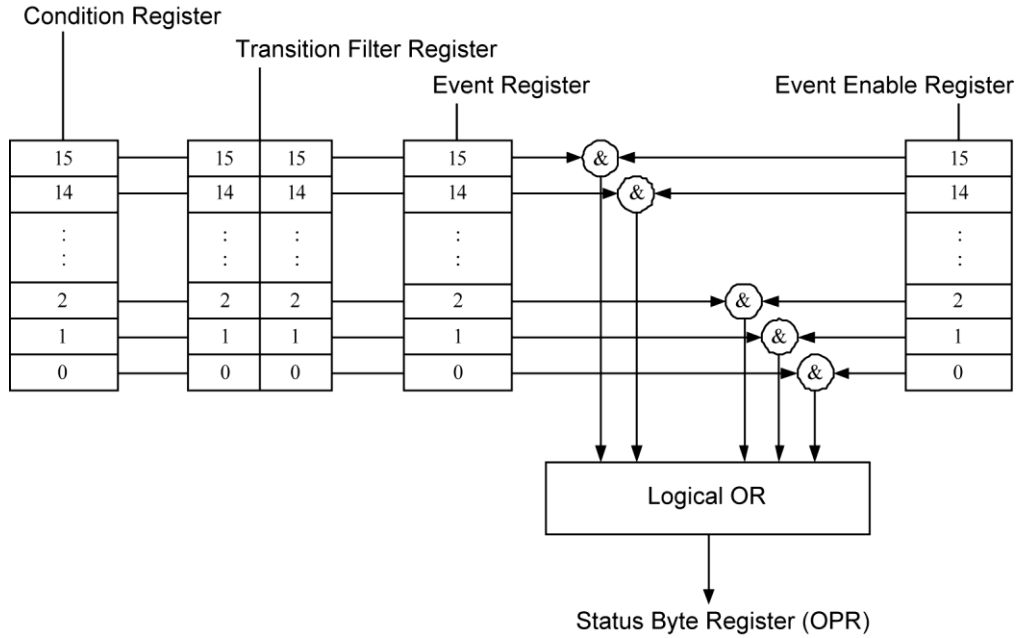

Figure 2.4 Warning Condition Register Group

2.2.6.1 Warning Condition Register

This register is not cleared even when a query addressed to the condition register is received.
Each bit of the warning condition register is described in Table 2.5.

Table 2.5 Warning Condition Register

Bit	Weight	Description
15	-	Always 0
14	16384	Peak current limiter is operating
13	8192	RMS current limiter is operating
12	4096	Active wattage limiter is operating
11	2048	Output OFF after peak current limiter is activated
10	1024	Output OFF after RMS current limiter is activated
9	512	Sensing voltage anomaly
8	256	Power unit DCPS anomaly
7	128	Synchronization frequency anomaly
6	64	Overheat
5	32	Power unit DCPS undervoltage
4	16	Power unit DCPS overvoltage
3	8	Output overcurrent (Peak)
2	4	Power unit anomaly
1	2	Output overcurrent (RMS)
0	1	Output overvoltage

2.2.6.2 Warning Status Transition Filter

The warning status transition filter is a filter for determining the event bit transition.

The warning status transition filter is not cleared even when the *CLS command is received.

For the relationship between the transition filter setting and the event register transitions, refer to Table 2.4.

2.2.6.3 Warning Event Register

The warning event register is a register that reflects the changes of the condition register according to the transition filter setting.

The event register is cleared upon reception of a query addressed to the event register or the *CLS command.

2.2.6.4 Warning Event Enable Register

The warning event enable register is used to select bits in the event register to be summarized.

2.2.7 System Lock Condition Register Group

The configuration of the System Lock condition register group is shown in Figure 2.5.

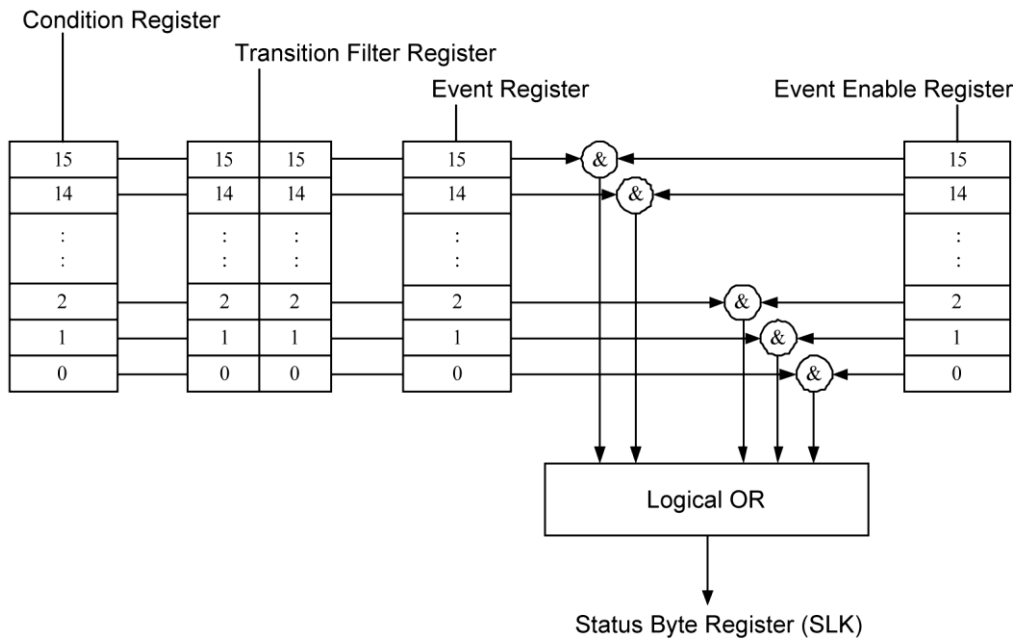

Figure 2.5 System Lock Condition Register Group

2.2.7.1 System Lock Condition Register

This register is not cleared even when a query addressed to the condition register is received.
Each bit of the System Lock condition register is described in Table 2.6.

Table 2.6 System Lock Condition Register

Bit	Weight	Description
15	-	Always 0
14	16384	(Unused)
13	8192	(Unused)
12	4096	(Unused)
11	2048	Starts with different power line voltage, in polyphase connection
10	1024	(Unused)
9	512	(Unused)
8	256	(Unused)
7	128	(Unused)
6	64	(Unused)
5	32	Polyphase system communication anomaly
4	16	Internal communication anomaly 2
3	8	Internal communication anomaly 1
2	4	Power input frequency anomaly
1	2	Power input undervoltage
0	1	Power input overvoltage

2.2.7.2 System Lock Status Transition Filter

The System Lock status transition filter is a filter for determining the event bit transition.

The System Lock status transition filter is not cleared even when the *CLS command is received.

For the relationship between the transition filter setting and the event register transitions, refer to Table 2.4.

2.2.7.3 System Lock Event Register

The System Lock event register is a register that reflects the changes of the condition register according to the transition filter setting.

The event register is cleared upon reception of a query addressed to the event register or the *CLS command.

2.2.7.4 System Lock Event Enable Register

The System Lock event enable register is used to select bits in the event register to be summarized.

3.Remote Command Overview

3.1 Remote Command	43
--------------------------	----

3.1 Remote Command

3.1.1 Command Type and Format Concept

There are two types of remote commands of KP3000S; the common commands defined in IEEE488.2, and the commands defined according to SCPI (Standard Commands for Programmable Instruments) command specifications.

3.1.2 About SCPI

SCPI is a standard that defines the communication method between external controllers and measuring instruments.

For general information about SCPI, refer to the following document:

Standard Commands for Programmable Instruments (SCPI) VERSION 1999.0

<http://www.ivifoundation.org/scpi/>

Conventions

The commands mentioned in the description are written following conventions:

< >	< > indicates something other than itself. In the case of parameter or response data, the abbreviation of the type is enclosed in < >. <NL> indicates an ASCII character that has the value of 10 decimal, and similarly, <^END> indicates EOI.
[]	The items enclosed in [] are optional. Note that "[" and "]" are not part of the command.
{abc xyz}	Means that either "abc" or "xyz" should be used.
[abc xyz]	Indicates that either "abc" or "xyz" can be used, but both are optional.
Uppercase, lowercase	A whole word consisting of the combination of upper and lowercase letters makes a long form of the keyword, while an uppercase only part makes a short form.

3.1.3 Supported Common Command

The KP3000S support the instrument common commands which comply with the IEEE488.2 standard.

All common commands begin with an asterisk (*), and some of them can use parameters.

The header of common command and the first parameter must be separated by a space code.

The common commands supported by the KP3000S are shown in Table 3.1.

Table 3.1 IEEE488.2 Common Commands Supported by KP3000S

Command Query	Name
*IDN?	Identification Query
*RST	Reset Command
*TST?	Self-Test Query
*OPC	Operation Complete Command
*OPC?	Operation Complete Query
*WAI	Wait-to-Continue Command
*CLS	Clear Status Command
*ESE	Standard Event Status Enable Command
*ESE?	Standard Event Status Enable Query
*ESR?	Standard Event Status Register Query
*SRE	Service Request Enable Command
*SRE?	Service Request Enable Query
*STB?	Read Status Byte Query

3.1.4 SCPI Command and Query Format

A SCPI command has a hierarchical structure that consists of a root keyword, one or more lower-level keywords, parameters, and suffixes.

The followings show examples of command and query.

```
:OUTPut:STATe ON<NL><^END>
```

```
:OUTPut:STATe?<NL><^END>
```

OUTPut is the root-level keyword that links second-level keywords. ON is a command parameter.

3.1.5 SCPI Subsystem Command Tree

3.1.5.1 Structure of Command Tree

SCPI applies a hierarchical structure similar to the one used in a file system to subsystem commands.

In SCPI, this command structure is called a command tree, and Figure 3.1 shows an example of a command tree.

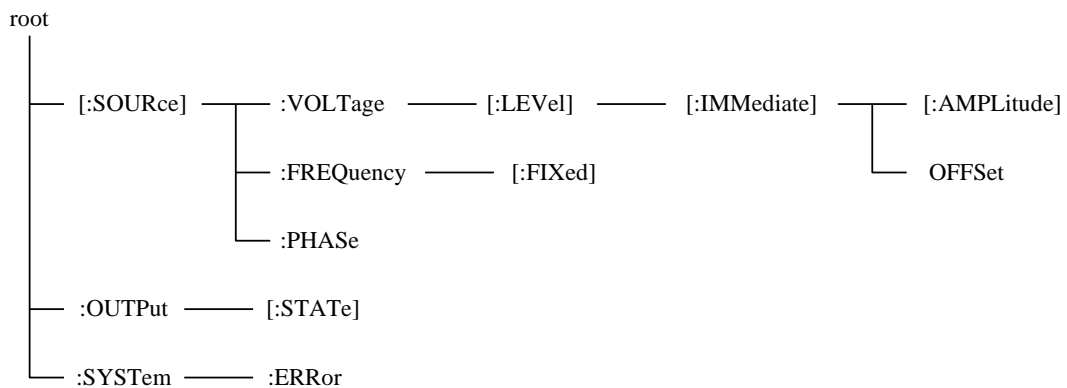

Figure 3.1 Example of Command Tree

In the command tree shown in Figure 3.1, the keywords closest to the top ("[:SOURce]", "[:OUTPut]", and "[:SYSTem]") are root-level keywords. To reach a lower-level keyword, you must follow the path of keywords defined above it.

For example, to access "[:OFFSet]", the command should be specified by following the path [:SOURce] - :VOLTage - [:LEVel] - [:IMMediate] - :OFFSet.

3.1.5.2 Current Path Movement

The current path is a level within the command tree, and becomes the first command path from which the command parser starts the search when the next command is sent. The command parser determines the current path according to the following rules.

(1) At power-on and reset

The current path is set to the root.

(2) Message terminator

Upon reception of <NL> (message terminator), the current path is set to the root.

(3) Colon (command separator)

When a colon is placed between two keywords, the colon moves the current path down one level in the command tree.

(4) Colon (root specifier)

When a colon is placed at the beginning of a command, the colon sets the current path to the root.

(5) Semicolon

Semicolons do not affect to the current path.

(6) Space

Spaces do not affect to the current path.

(7) Comma

Commas do not affect to the current path.

(8) IEEE488.2 common command

Common commands do not affect to the current path.

By using semicolons properly, multiple commands can be sent efficiently.

For example,

```
:SOURce:VOLTage:LEVel:IMMediate:AMPLitude 1.0; OFFSet 1.0<NL><^END>
```

is the same as sending the following two commands:

```
:SOURce:VOLTage:LEVel:IMMediate:AMPLitude 1.0<NL><^END>
```

```
:SOURce:VOLTage:LEVel:IMMediate:OFFSet 1.0<NL><^END>
```

When an optional keyword is omitted, you should pay careful attention to the current path movement.

For example,

```
:VOLTage 1.0<NL><^END>
```

sets the current path to ":SOURce."

If you want to send the following two program messages as one program message,

```
:SOURce:VOLTage:LEVel:IMMediate:AMPLitude 1.0<NL><^END>  
:SOURce:FREQuency:FIXed 100.0<NL><^END>
```

<Program message which is executed properly>

```
:SOURce:VOLTage 1.0; FREQuency:FIXed 100.0<NL><^END>
```

<Program message which causes parsing error>

```
:SOURce:VOLTage:LEVel:IMMediate:AMPLitude1.0; FREQuency:FIXed 100.0<NL><^END>
```

Here, the current path of the second command is

":SOURce:VOLTage:LEVel:IMMediate" (by right, it must be ":SOURce"). Therefore, ":FREQuency:FIXed 100.0" causes parsing error.

3.1.6 Elements of SCPI Commands

3.1.6.1 Common Command Syntax

The syntax of common commands is shown in Figure 3.2. In this figure, a keyword consists of three alphanumeric characters, beginning with an alphabetic character.

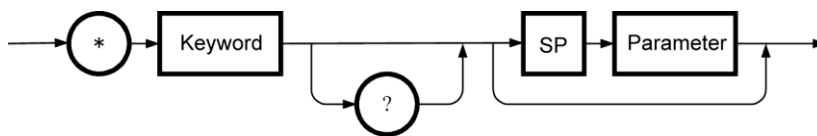

Figure 3.2 Common Command Syntax

"SP" in Figure 3.2 is technically as shown in Figure 3.3 (hereinafter, all SP means the same).

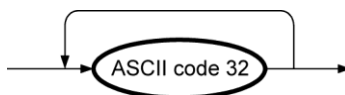

Figure 3.3 SP Syntax

3.1.6.2 Subsystem Command Syntax

The syntax of the subsystem commands is shown in Figure 3.4.

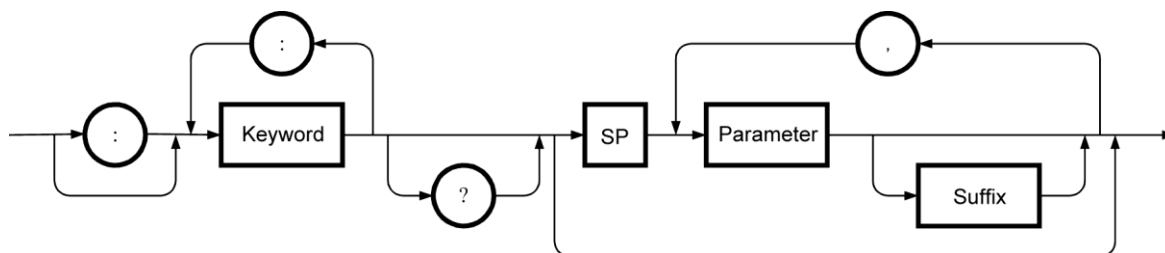

Figure 3.4 Subsystem Command Syntax

3.1.6.3 Keyword

The keyword in the command syntax is a string of up to 12 characters consisting of uppercase and lowercase alphabetic characters, underscore (_), and numeric characters, beginning with an alphabetic character.

Most keywords are shown as a mixture of uppercase and lowercase characters.

The uppercase characters represent the short form for commands. Either long or short form format can be accepted; commands are not case sensitive actually.

Examples for the keyword "OUTPut" are listed in Table 3.2.

Table 3.2 Acceptable and Unacceptable Keywords (for "OUTPut")

Keyword	Description
OUTPUT	Accepted as long form.
OUTP	Accepted as short form.
OuTpUt	Accepted as long form without distinguishing uppercase and lowercase characters.
oUtP	Accepted as short form without distinguishing uppercase and lowercase characters.
OUTPU	Not accepted because it corresponds to neither long form nor short form.
OUT	Not accepted because it corresponds to neither long form nor short form.

3.1.6.4 Keyword Separator

Keyword separators serve to separate the current keyword and the next lower-level keyword as shown in the example below. Colons (:) are used as keyword separators.

:OUTPut:STATe?

3.1.6.5 Root Specifier

A colon (:) at the beginning of the subsystem command serves as a root specifier.

The root specifier sets the current path to the root.

As colons (:) are also used as command separators, you need to carefully use them depending on your purpose.

SOURce:FREQuency:FIXed 100.0

→ All colons are header separators

:SOURce:FREQuency:FIXed 1.0

→ The first colon is the root specifier

SOURce:FREQuency:FIXed 100.0; :OUTPut ON

→ The third colon is the root specifier

3.1.6.6 Optional Keywords

The keywords enclosed in square brackets ([]) are optional, and can be omitted. However, the square brackets ([]) are used for description purpose only, and are not included in the actual command to be sent.

If the keyword is omitted, the command parser interprets the command as if that optional keyword is received.

For example,

:OUTPut[:STATe]

means that you can use either of the following commands:

:OUTPut:STATe

:OUTPut

3.1.6.7 Implied Channels (Optional Numeric Keyword Suffix)

Many commands allow you to specify channels by using an optional numeric keyword suffix. For example,

```
:OUTPut[1|2]:STATe {ON|OFF}
```

means commands for channel 1 and 2 as follows:

```
:OUTPut[1]:STATe {ON|OFF}
:OUTPut2:STATe {ON|OFF}
```

Here, you need to note that if you do not specify the channel number, the channel 1 will be selected as an implied channel.

For example, to control the channel 1 output to be turned ON, you can use either of the following commands.

```
:OUTPut1:STATe ON
:OUTPut:STATe ON
```

3.1.6.8 Parameter Type

In the command list, the angle brackets (<>) indicate parameters. The parameter type is one of the following types.

Numeric parameter (<REAL>, <INT>)

The syntax of numeric parameters is shown in Figure 3.5.

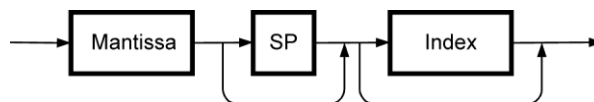

Figure 3.5 Numeric Parameter (<REAL>, <INT>) Syntax

The syntaxes of the mantissa and index in Figure 3.5 are shown in Figure 3.6 and Figure 3.7.

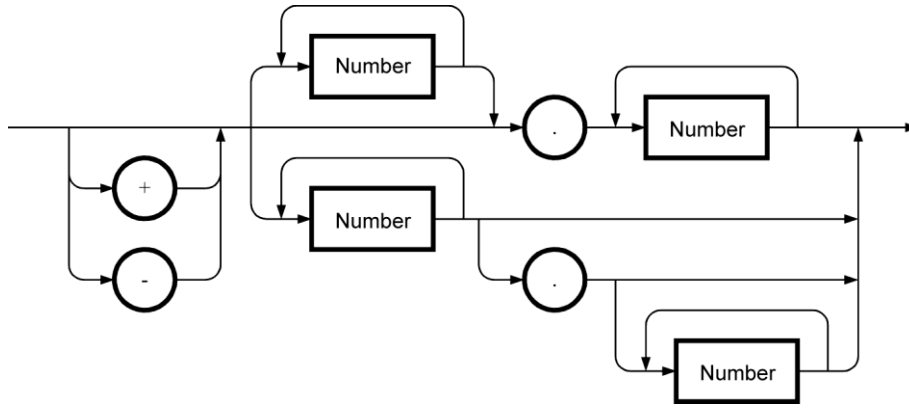

Figure 3.6 Mantissa Syntax

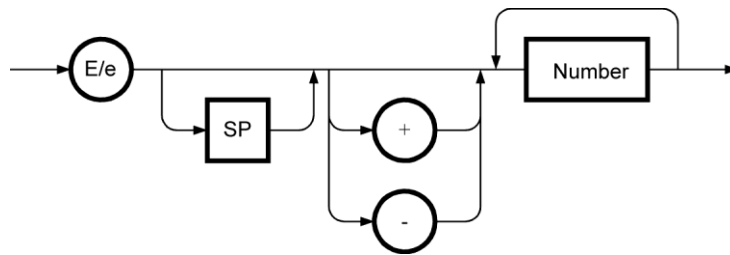

Figure 3.7 Index Syntax

3.1.6.9 Discrete Parameter (<DISC>)

The syntax of the discrete parameter is shown in Figure 3.8.

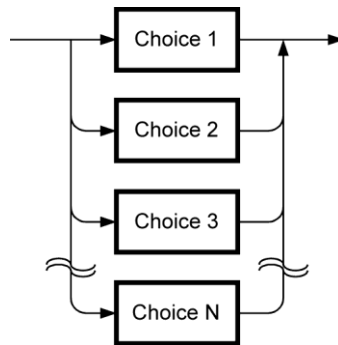

Figure 3.8 Discrete Parameter (<DISC>) Syntax

3.1.6.10 Boolean Value Parameter (<BOL>)

The syntax of the Boolean value parameter is shown in Figure 3.9.

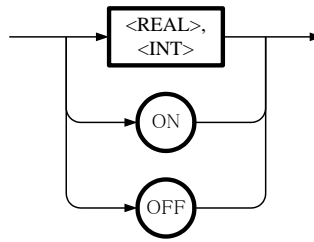

Figure 3.9 Boolean Value Parameter (<BOL>) Syntax

The boolean parameter is interpreted the values other than 0 as true, and 0 as false.

If the specified value includes a fractional part, that value is interpreted as the whole number obtained by rounding the fractional part. Therefore, "0.4" is false (rounded off to 0), and "0.5" is true (rounded off to 1).

3.1.6.11 String Program Data (<STR>)

The syntax of the string program data is shown in Figure 3.10.

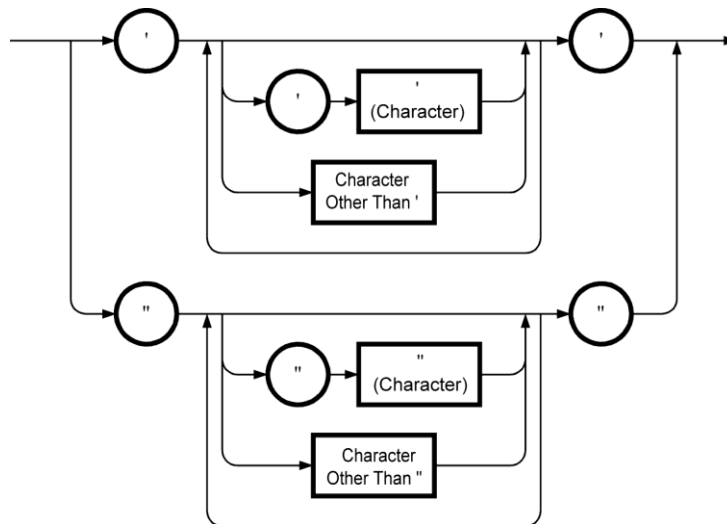

Figure 3.10 String Parameter (<STR>) Syntax

In the KP3000S, you cannot use the following nine characters as a part of a string: \, /, :, *, ?, “, <, >, |. If the string includes one of these characters, an error process will be raised.(The error message returns an error code :-150 "String data error.")

3.1.6.12 Block Program Data (<BLK>)

The syntax of the block program data is shown in Figure 3.11.

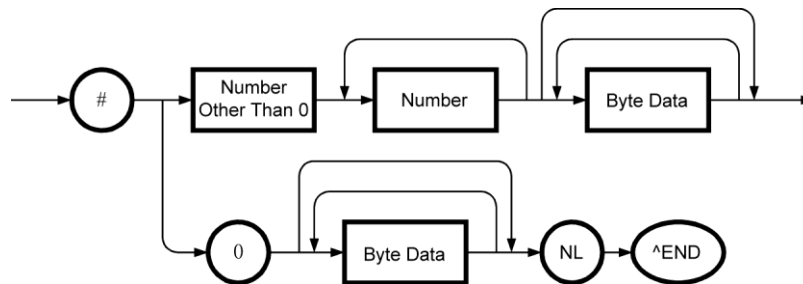

Figure 3.11 Block Program Data (<BLK>) Syntax

For the definite length block program data, if "^END" is received before receiving the specified number of bytes, it is treated as a command error.

The KP3000S only accept the definite length block program data, and the number string between # and the first byte data is fixed to 48192. The byte data must be 8192 bytes.

3.1.6.13 Parameter Separator

If you want to send multiple parameters in one command, you need to separate the adjacent parameters with a comma (,).

3.1.6.14 Query Parameter

Most of the queries supported by the commands that have decimal numeric parameters can return the minimum or maximum values if "MINimum" or "MAXimum" is specified after "?". For example, to query the minimum and maximum values of the frequency, send the following queries:

```
:SOURce:FREQuency? MINimum
:SOURce:FREQuency? MAXimum
```

3.1.6.15 Suffix

The syntax of suffix is shown in Figure 3.12.

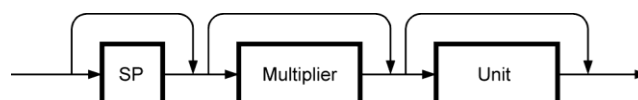

Figure 3.12 Suffix Syntax

3.1.6.16 Command Terminator

A command terminator is either <NL> (ASCII character decimal 10), an EOI (End-of Identify) asserted by the last byte, or an EOI asserted by <NL>.

Using multiple commands

Program message

A program message is a combination of one or more IEEE488.2 common commands and SCPI commands, and used to send multiple commands at once.

Program Message Syntax

The syntax of the program message is shown in Figure 3.13.

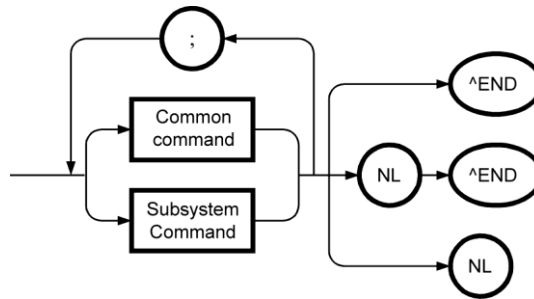

Figure 3.13 Program Message Syntax

3.1.7 Overview of Response Message Formats

3.1.7.1 Response Message

The response data that can be read from the KP3000S when the command is sent by the computer to inquire something is called "response message." The command sent by the computer is called "query", and a question mark (?) is placed at the end of the command.

3.1.7.2 Response Message Syntax

The syntax of the response message is shown in Figure 3.14.

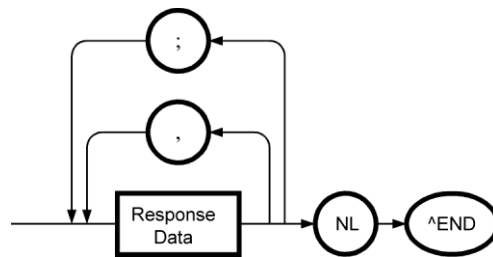

Figure 3.14 Response Message Syntax

In response messages, commas (,) and semicolons (;) are used as separators. When multiple values are returned by one command, data items are separated by commas (,).

When multiple queries are sent in the same message, the data item groups for each query are separated by semicolons (;).

3.1.7.3 Response Message Data Type

The data type of the response message is one of the followings:

Real number response data syntax (<REAL>)

The syntax of the real number response data is shown in Figure 3.15.

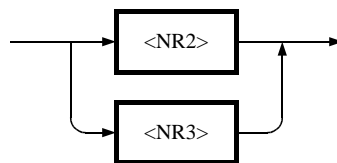

Figure 3.15 Real Number Response Data (<REAL>) Syntax

The syntax of the NR2 number response data is shown in Figure 3.16.

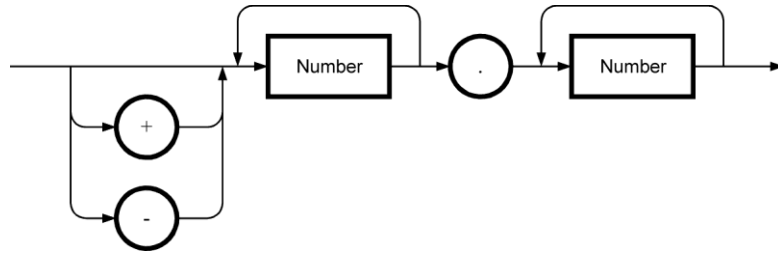

Figure 3.16 NR2 Number Response Data (<NR2>) Syntax

The syntax of the NR3 number response data is shown in Figure 3.17.

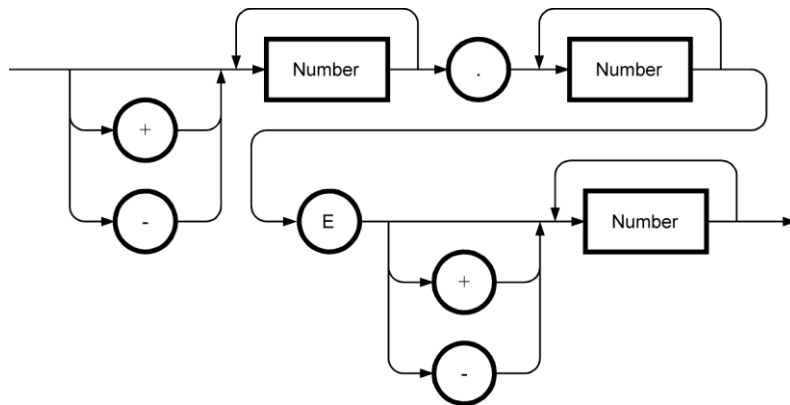

Figure 3.17 NR3 Number Response Data (<NR3>) Syntax

Integer response data (<INT>)

The syntax of the integer response data is shown in Figure 3.18. The integer response data syntax is same as that of the NR1 number response data defined in IEEE488.2.

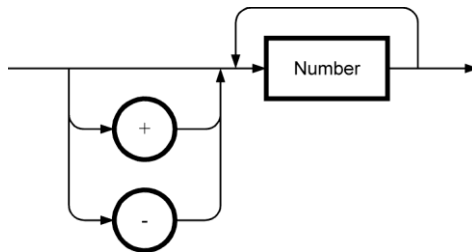

Figure 3.18 Integer Response Data (<INT>) Syntax

Discrete response data (<DISC>)

The syntax of the discrete response data is shown in Figure 3.19.

The response data is always in short form.

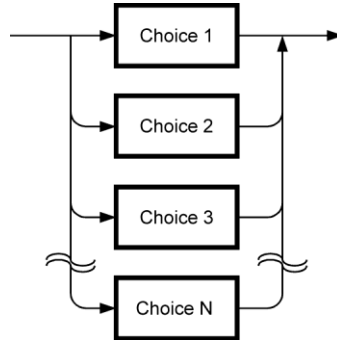

Figure 3.19 Discrete Response Data (<DISC>) Syntax

Numeric Boolean value response data (<NBOL>)

The syntax of the numeric Boolean value response data is shown in Figure 3.20.

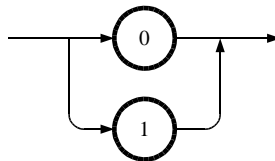

Figure 3.20 Numeric Boolean Value Response Data (<NBOL>) Syntax

String response data (<STR>)

The syntax of the string response data is shown in Figure 3.21.

Note that double quotation (") is never contained in a response string in the KP3000S.

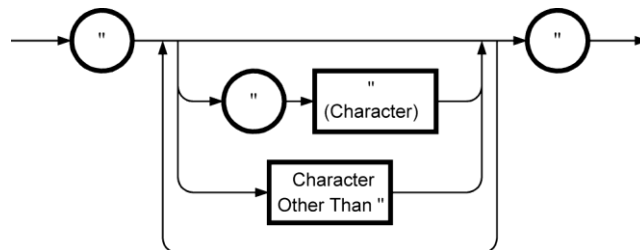

Figure 3.21 String Response Data (<STR>) Syntax

Definite length arbitrary block response data (<DBLK>)

The syntax of the definite length arbitrary block response data is shown in Figure 3.22.

However, the KP3000S does not return this type of response message.

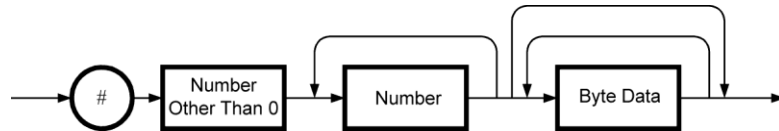

Figure 3.22 Definite Length Arbitrary Block Response Data Syntax (<DBLK>)

Indefinite length arbitrary block response data (<IBLK>)

The syntax of the indefinite length arbitrary block response data is shown in Figure 3.23.

However, the KP3000S does not return this type of response message.

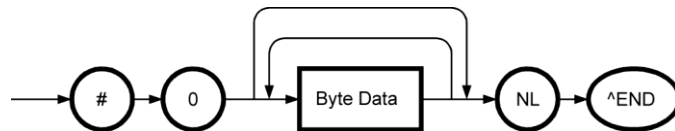

Figure 3.23 Indefinite Length Arbitrary Block Response Data Syntax (<IBLK>)

4. Remote Command Reference

4.1 Program Command List.....	61
4.2 Program Command Description	72

4.1 Program Command List

This chapter describes the program commands for the KP3000S.

Some commands may be given permission or inhibition of acceptance for each output function.

Some other commands may be handled as a command error or may not be accepted, to maintain the integrity of the internal operation state of the KP3000S.

For these commands that require special attentions, tips are described to run them properly in "Program Command Description".

4.1.1 List of Commands Common to Functions

Function	Command	Set	Query
Common Command (IEEE488.2)			
Device ID	*IDN?	—	○
Self-Check	*TST?	—	○
Clear event register and error queue	*CLS	○	—
Set/get the standard event status enable register	*ESE	○	○
Get the standard event status register	*ESR?	—	○
Set/get the service request enable register	*SRE	○	○
Get the status byte register	*STB?	—	○
Wait for synchronization of the overlap command	*WAI	○	—
Set the OPC bit at the operation completion	*OPC	○	—
Get the operation completion state	*OPC?	—	○
Operate System Lock Condition Register			
Get the System Lock condition register	:STATus:LOCK:CONDition?	—	○
Set/get the System Lock event enable register	:STATus:LOCK:ENABle	○	○
Get the System Lock event register	:STATus:LOCK[:EVENT]?	—	○
Set/get the System Lock transition filter (negative)	:STATus:LOCK:NTRansition	○	○
Set/get the System Lock transition filter (positive)	:STATus:LOCK:PTRansition	○	○
Operate Operation Condition Register			
Operation condition register	:STATus:OPERation:CONDition?	—	○
Operation event enable register	:STATus:OPERation:ENABle	○	○
Operation event register	:STATus:OPERation[:EVENT]?	—	○
Operation transition filter (negative)	:STATus:OPERation:NTRansition	○	○
Operation transition filter (positive)	:STATus:OPERation:PTRansition	○	○
Get Error Message			
Get error messages	:SYSTem:ERRor?	—	○

Operate Warning Condition Register			
Get the warning condition register	:STATus:WARNing:CONDition?	—	○
Set/get the warning event enable register	:STATus:WARNing:ENABLE	○	○
Get the warning event register	:STATus:WARNing[:EVENT]?	—	○
Set/get the warning transition filter (negative)	:STATus:WARNing:NTRansition	○	○
Set/get the warning transition filter (positive)	:STATus:WARNing:PTRansition	○	○
Release the warning	:SYSTem:WRELease	○	—
Output Control			
Output on/off	:OUTPut[:STATe]	○	○
Output at power-on	:OUTPut:PON	○	○
Output relay control	:OUTPut:RELAy	○	○
Trigger output polarity	:TRIGger:POLarity	○	○
Trigger output pulse width	:TRIGger:WIDTh	○	○
Device Configuration			
Get the phase configuration	:SYSTem:CONFigure:PHASe?	—	○
Set/Get Output Function			
Output function	:SYSTem:CONFigure[:MODE]	○	○
Set Panel Display Operation			
LCD contrast adjustment value	:DISPlay:CONTRast	○	○
LCD display color	:DISPlay[:WINDow]:BACKground:COLor	○	○
Key lock	:SYSTem:KLOCK	○	○
Beep	:SYSTem:BEEPer:STATe	○	○
Get Power Unit State			
Get the number of connected units	:SYSTem:CONFigure:NPU[:STATe]?	—	○
Get the number of energizations	:SYSTem:CONFigure:NPU:ENABLE?	—	○
Get the error status	:SYSTem:CONFigure:NPU:ERRor?	—	○
Set Monitor Output			
Monitor output	:OUTPut:MONitor:MODE	○	○
Specify the output phase (phase number)	:OUTPut:INSTRument:NSElect	○	○
Specify the output phase (phase)	:OUTPut:INSTRument:SElect	○	○

4.1.2 List of Continuous Function Commands

Function	Command	Set	Query
Common Command (IEEE488.2)			
Initialize the basic setting	*RST	○	—
Select/set the basic setting	*RCL	○	—
Store the basic setting	*SAV	○	—
Set Panel Display			
Set/get the Normal View/Simple View mode	:DISPlay[:WINDow]:DESIgn:MODE	○	○
Set/get the display items at Simple View	:DISPlay[:WINDow]:DESIgn:SIMPlE:ITEM	○	○
Set the measurement display phase (phase number)	:DISPlay[:WINDow]:INSTrument:NSElect	○	○
Set the measurement display phase (phase)	:DISPlay[:WINDow]:INSTrument:SElect	○	○
Set/get the measurement display selection	:DISPlay[:WINDow]:MEASure:MODE	○	○
Output Setting (for All Phases)			
Set/get the output range*1	[:SOURce]:VOLTage:RANGe	○	○
Set the AC/DC mode*1	[:SOURce]:MODE	○	○
Set/get the output frequency	[:SOURce]:FREQUency[:IMMEdiate]	○	○
Set the output on phase	[:SOURce]:PHASe:STARt[:IMMEdiate]	○	○
Enable/disable the output off phase specification	[:SOURce]:PHASe:STOP:ENABle	○	○
Set the output off phase	[:SOURce]:PHASe:STOP[:IMMEdiate]	○	○
Set/get the balanced/unbalanced mode	[:SOURce]:PHASe:MODE	○	○
Set the remote sensing function*3	:MEASure:CONFIgure:SENSing	○	○
Output Setting (for Specific Phase)			
Specify the phase to set (phase number)	:INSTrument:NSElect	○	○
Specify the phase to set (phase)	:INSTrument:SElect	○	○
Set/get the AC output voltage	[:SOURce]:VOLTage[:LEVel][:IMMEdiate][:AMPLitude]	○	○
Set/get the DC output voltage	[:SOURce]:VOLTage[:LEVel][:IMMEdiate]:OFFSet	○	○
Select the output waveform	[:SOURce]:FUNCTion[:SHAPe][:IMMEdiate]	○	○
Set/get the phase angle at polyphase system	[:SOURce]:PHASe:PHASe	○	○

Set the DC offset voltage adjustment value (AC mode)	[:SOURce]:VOLTage:ADJust:OFFSet:AC	○	○
Set the DC offset voltage adjustment value (ACDC and DC modes)	[:SOURce]:VOLTage:ADJust:OFFSet:DC	○	○
Voltage Setting Range Limit			
Voltage setting range limit (effective value)	[:SOURce]:VOLTage:LIMit:RMS	○	○
Voltage setting range (peak value <maximum>)	[:SOURce]:VOLTage:LIMit:HIGH	○	○
Voltage setting range (peak value <minimum>)	[:SOURce]:VOLTage:LIMit:LOW	○	○
Current Limiter			
Set the current limiter (effective value)	[:SOURce]:CURRent:LIMit:RMS[:AMPLitude]	○	○
Set off after the current limiter (effective value) is activated	[:SOURce]:CURRent:LIMit:RMS:MODE	○	○
Set the time before turning off after the current limiter (effective value) is activated	[:SOURce]:CURRent:LIMit:RMS:TIME	○	○
Set the current limiter (peak value <maximum>)	[:SOURce]:CURRent:LIMit:PEAK:HIGH	○	○
Set the current limiter (peak value <minimum>)	[:SOURce]:CURRent:LIMit:PEAK:LOW	○	○
Set off after the current limiter (peak value) is activated	[:SOURce]:CURRent:LIMit:PEAK:MODE	○	○
Time before turning off after the current limit (peak value) is activated	[:SOURce]:CURRent:LIMit:PEAK:TIME	○	○
Frequency Setting Range Limit			
Set the upper limit value of the frequency setting range limit	[:SOURce]:FREQuency:LIMit:HIGH	○	○
Set the lower limit value of the frequency setting range limit	[:SOURce]:FREQuency:LIMit:LOW	○	○
Get Output Measured Value			
Clear the output current peak-hold value	:MEASure[:SCALar]:CURRent:PEAK:CLEar	○	—
Get the output current peak-hold value	:MEASure[:SCALar]:CURRent:PEAK:HOLD?	—	○
Get the synchronization signal source frequency	:MEASure[:SCALar]:FREQuency?	—	○

Get Output Measured Value (for Specific Phase)			
Specify the measurement query phase (phase number)	:MEASure:INSTrument:NSElect	○	○
Specify the measurement query phase (phase)	:MEASure:INSTrument:SElect	○	○
Output voltage (effective value)	:MEASure[:SCALar]:VOLTage[:RMS]?	—	○
Output voltage (average value)	:MEASure[:SCALar]:VOLTage:AVErage?	—	○
Output voltage (peak value <maximum>)	:MEASure[:SCALar]:VOLTage:HIGH?	—	○
Output voltage (peak value <minimum>)	:MEASure[:SCALar]:VOLTage:LOW?	—	○
Output current (effective value)	:MEASure[:SCALar]:CURRent[:RMS]?	—	○
Output current (average value)	:MEASure[:SCALar]:CURRent:AVErage?	—	○
Output current (peak value <maximum>)	:MEASure[:SCALar]:CURRent:HIGH?	—	○
Output current (peak value <minimum>)	:MEASure[:SCALar]:CURRent:LOW?	—	○
Control the harmonic current measurement function	:MEASure[:SCALar]:CURRent:HARMonic:ENABLE	○	○
Get the harmonic current value	:MEASure[:SCALar]:CURRent:HARMonic[:RMS]?	—	○
Get the harmonic current percentage	:MEASure[:SCALar]:CURRent:HARMonic:RATio?	—	○
Get the output current crest factor	:MEASure[:SCALar]:CURRent:CFACtor?	—	○
Get the apparent power	:MEASure[:SCALar]:POWER[:AC]:APParent?	—	○
Get the power factor	:MEASure[:SCALar]:POWER[:AC]:PFACtor?	—	○
Get the reactive power	:MEASure[:SCALar]:POWER[:AC]:REACTive?	—	○
Get the active power	:MEASure[:SCALar]:POWER[:AC][:REAL]?	—	○
CO₂ Calculation Function			
Clear the emission CO ₂ integration value	:MEASure: CO2:TOTal:CLEar	○	—
Set/get the emission CO ₂ coefficient	:MEASure: CO2:COEFFicient	○	○
Get the emission CO ₂ internal loss instantaneous value	:MEASure: CO2:RATE:LOSS?	—	○
Get the emission CO ₂ output power instantaneous value	:MEASure: CO2:RATE:OUTPut?	—	○
Get the emission CO ₂ internal loss integration value	:MEASure: CO2:TOTal:LOSS?	—	○
Get the emission CO ₂ output power integration value	:MEASure: CO2:TOTal:OUTPut?	—	○

AGC/Autocal Function Setting			
Enable/disable the AGC function*3	:OUTPut:AGC	<input type="radio"/>	<input type="radio"/>
Enable/disable the Autocal function*3	:OUTPut:ACALibration	<input type="radio"/>	<input type="radio"/>
Set External Input Signal			
External input gain	:INPut:GAIN	<input type="radio"/>	<input type="radio"/>
External synchronization signal source	:INPut:SYNC:SOURce	<input type="radio"/>	<input type="radio"/>
Set/Get Output Waveform			
Set/get the clipped sine wave type specification*2	[:SOURce]:FUNCtion:CSINe:TYPE	<input type="radio"/>	<input type="radio"/>
Set/get the clipped sine wave crest factor*2	[:SOURce]:FUNCtion:CSINe:CFACTOR	<input type="radio"/>	<input type="radio"/>
Set/get the clipped sine wave clip ratio*2	[:SOURce]:FUNCtion:CSINe:CLIP	<input type="radio"/>	<input type="radio"/>
Save the clipped sine wave*2	:TRACe DATA:CSINe:STORe	<input type="radio"/>	—
Initialize the arbitrary wave memory*2	:TRACe DATA:WAVE:CLEAr	<input type="radio"/>	—
Transfer the arbitrary wave data*2	:TRACe DATA:WAVE[:DATA]	<input type="radio"/>	—
Specify the arbitrary wave name	:TRACe DATA:WAVE:NAME	<input type="radio"/>	<input type="radio"/>
Set External Control Signal			
Permit/inhibit the external control input	:SYSTem:CONFigure:EXTio[:STATe]	<input type="radio"/>	<input type="radio"/>
Set/get the external control state output polarity	:SYSTem:CONFigure:EXTio:POLarity	<input type="radio"/>	<input type="radio"/>

*1 The setting is held by each output function.

After the output function is switched, the setting held by the new output function is forcibly used.

*2 The setting in the Continuous function is reflected to the Sequence and Simulation functions.

Switch to the Continuous function first, and then make the setting.

After making the setting, switch back to the output function to run.

*3 Switching the output function from the Continuous function to another forcibly releases the operation setting.

When you want to return from another function and enable the operation setting in the Continuous function again, you must make the operation setting.

4.1.3 List of Sequence Function Commands

Function	Command	Set	Query
Set Panel Display			
Set the Step Time display unit	:DISPlay[:WINDow]:TIME:UNIT	○	○
Sequence Function Control			
Get the state	[:SOURce]:SEQuence:CONTRol[:STATe]?	—	○
Control the execution	:TRIGger:SEQuence:SELEcted:EXECute	○	—
Switch to the Edit mode	[:SOURce]:SEQuence:EDIT	○	—
Compile the setting parameter and switch to the Control mode	:TRIGger:SEQuence:COMPile	○	—
Get the running step number	[:SOURce]:SEQuence:CSTep?	—	○
Set Parameter Common to Steps (Enabled at Edit Mode)			
Set the Step-control parameter	[:SOURce]:SEQuence:CPARAmeter	○	○
Set Parameter for Specified Step (Enabled at Edit Mode)			
Specify the step number to set	[:SOURce]:SEQuence:STEP	○	○
Specify the phase to set (phase number)	[:SOURce]:SEQuence:INSTrument:NSElect	○	○
Specify the phase to set (phase)	[:SOURce]:SEQuence:INSTrument:SELEct	○	○
Set the intra-Step parameter	[:SOURce]:SEQuence:SPARAmeter	○	○
Initialize/Read/Save Sequence Data (Enabled at Edit Mode)			
Initialize the Sequence data	:TRACe DATA:SEQuence:CLEAr	○	—
Sequence data name	:TRACe DATA:SEQuence:NAME	○	○
Read the Sequence data	:TRACe DATA:SEQuence:RECall	○	—
Save the Sequence data	:TRACe DATA:SEQuence:STORe	○	—

4.1.4 List of Simulation Function Commands

Function	Command	Set	Query
Set Panel Display			
Set the Step Time display unit	:DISPlay[:WINDow]:TIME:UNIT	○	○
Sequence Function Control			
Get the state	[:SOURce]:SIMulation:CONTRol[:STATe]?	—	○
Control the execution	:TRIGger:SIMulation:SElected:EXECute	○	—
Switch to the Edit mode	[:SOURce]:SIMulation:EDIT	○	—
Compile the setting parameter and switch to the Control mode	:TRIGger:SIMulation:COMPIle	○	—
Get the running step number	[:SOURce]:SIMulation:CSTep?	—	○
Set Repeat Execution (Enabled at Edit Mode)			
Enable/disable the repeat execution	[:SOURce]:SIMulation:REPeat:ENABLE	○	○
Set the repeat execution count	[:SOURce]:SIMulation:REPeat:COUNT	○	○
Set Parameter for Initial Step (Enabled at Edit Mode)			
Set the output voltage	[:SOURce]:SIMulation:INITial:VOLTage	○	○
Set the frequency	[:SOURce]:SIMulation:INITial:FREQUency	○	○
Enable/disable the start phase specification	[:SOURce]:SIMulation:INITial:PHASe:START:ENABLE	○	○
Set the start phase	[:SOURce]:SIMulation:INITial:PHASe:START[:IMMediate]	○	○
Enable/disable the stop phase specification	[:SOURce]:SIMulation:INITial:PHASe:STOP:ENABLE	○	○
Set the stop phase	[:SOURce]:SIMulation:INITial:PHASe:STOP[:IMMediate]	○	○
Set the synchronization output	[:SOURce]:SIMulation:INITial:CODE	○	○
Set Parameter for Normal 1 Step (Enabled at Edit Mode)			
Set the execution time	[:SOURce]:SIMulation:NORMal1:TIME	○	○
Set the output voltage	[:SOURce]:SIMulation:NORMal1:VOLTage	○	○
Set the frequency	[:SOURce]:SIMulation:NORMal1:FREQUency	○	○
Enable/disable the start phase specification	[:SOURce]:SIMulation:NORMal1:PHASe:START:ENABLE	○	○
Set the start phase	[:SOURce]:SIMulation:NORMal1:PHASe:START[:IMMediate]	○	○
Enable/disable the stop phase specification	[:SOURce]:SIMulation:NORMal1:PHASe:STOP:ENABLE	○	○
Set the stop phase	[:SOURce]:SIMulation:NORMal1:PHASe:STOP[:IMMediate]	○	○
Set the synchronization output	[:SOURce]:SIMulation:NORMal1:CODE	○	○
Set the trigger output (G1)	[:SOURce]:SIMulation:NORMal1:TRIGger[:STATe]	○	○

Set Parameter for Trans 1 Step (Enabled at Edit Mode)			
Set the execution time	[:SOURce]:SIMulation:TRANsition1:TIME	<input type="radio"/>	<input type="radio"/>
Set the synchronization output	[:SOURce]:SIMulation:TRANsition1:CODE	<input type="radio"/>	<input type="radio"/>
Set the trigger output (G2)	[:SOURce]:SIMulation:TRANsition1:TRIGger[:STATe]	<input type="radio"/>	<input type="radio"/>
Set Parameter for Abnormal Step Parameter (Enabled at Edit Mode)			
Set the execution time	[:SOURce]:SIMulation:ABNormal:TIME	<input type="radio"/>	<input type="radio"/>
Set the output voltage	[:SOURce]:SIMulation:ABNormal:VOLTagE	<input type="radio"/>	<input type="radio"/>
Set the frequency	[:SOURce]:SIMulation:ABNormal:FREQuency	<input type="radio"/>	<input type="radio"/>
Enable/disable the start phase specification	[:SOURce]:SIMulation:ABNormal:PHASe:STARt:ENABle	<input type="radio"/>	<input type="radio"/>
Set the start phase	[:SOURce]:SIMulation:ABNormal:PHASe:STARt[:IMMEdiate]	<input type="radio"/>	<input type="radio"/>
Enable/disable the stop phase specification	[:SOURce]:SIMulation:ABNormal:PHASe:STOP:ENABle	<input type="radio"/>	<input type="radio"/>
Set the stop phase	[:SOURce]:SIMulation:ABNormal:PHASe:STOP[:IMMEdiate]	<input type="radio"/>	<input type="radio"/>
Set the synchronization output	[:SOURce]:SIMulation:ABNormal:CODE	<input type="radio"/>	<input type="radio"/>
Set the trigger output (G3)	[:SOURce]:SIMulation:ABNormal:TRIGger[:STATe]	<input type="radio"/>	<input type="radio"/>
Set Parameter for Trans 2 Step (Enabled at Edit Mode)			
Set the execution time	[:SOURce]:SIMulation:TRANsition2:TIME	<input type="radio"/>	<input type="radio"/>
Set the synchronization output	[:SOURce]:SIMulation:TRANsition2:CODE	<input type="radio"/>	<input type="radio"/>
Set the trigger output (G4)	[:SOURce]:SIMulation:TRANsition2:TRIGger[:STATe]	<input type="radio"/>	<input type="radio"/>
Set Parameter for Normal 2 Step (Enabled at Edit Mode)			
Set the execution time	[:SOURce]:SIMulation:NORMAl2:TIME	<input type="radio"/>	<input type="radio"/>
Enable/disable the start phase specification	[:SOURce]:SIMulation:NORMAl2:PHASe:STARt:ENABle	<input type="radio"/>	<input type="radio"/>
Set the start phase	[:SOURce]:SIMulation:NORMAl2:PHASe:STARt[:IMMEdiate]	<input type="radio"/>	<input type="radio"/>
Enable/disable the stop phase specification	[:SOURce]:SIMulation:NORMAl2:PHASe:STOP:ENABle	<input type="radio"/>	<input type="radio"/>
Set the stop phase	[:SOURce]:SIMulation:NORMAl2:PHASe:STOP[:IMMEdiate]	<input type="radio"/>	<input type="radio"/>
Set the synchronization output	[:SOURce]:SIMulation:NORMAl2:CODE	<input type="radio"/>	<input type="radio"/>
Set the trigger output (G5)	[:SOURce]:SIMulation:NORMAl2:TRIGger[:STATe]	<input type="radio"/>	<input type="radio"/>

Initialize/Read/Save Simulation (Enabled at Edit Mode)			
Initialize the Simulation data	:TRACe DATA:SIMulation:CLEAr	<input type="radio"/>	—
Simulation data name	:TRACe DATA:SIMulation:NAME	<input type="radio"/>	<input type="radio"/>
Read the Simulation data	:TRACe DATA:SIMulation:RECall	<input type="radio"/>	—
Save the Simulation data	:TRACe DATA:SIMulation:STORE	<input type="radio"/>	—

4.2 Program Command Description

4.2.1 Commands Common to Functions

4.2.1.1 Common Command (IEEE488.2): Device ID

*IDN?

Description

Gets the device ID

Query parameter

None

Response format

<STR>

Query example

*IDN?

Response example

NF Corporation,KP3000S,1234567,1.00

4.2.1.2 Common Command (IEEE488.2): Self-Check

*TST?

Description

Gets the self-check result

For the KP3000S, it always returns 0 without performing the self-check

Query parameter

None

Response format

<INT>

Query example

*TST?

Response example

0

Remarks

The response message to the query is not returned during the System Lock.

4.2.1.3 Common Command (IEEE488.2): Clear Event Register and Error Queue

*CLS

Description

Clears event register and error queue

For the event register, see 2.2.2, 2.2.4.1, 2.2.5.3, 2.2.6.3, and 2.2.7.3

Setting parameter

None

Setting example

*CLS

4.2.1.4 Common Command (IEEE488.2): Set/Get Standard Event Status Enable Register

*ESE

Description

Sets/Gets the standard event status enable register

For the standard event status enable register, see 2.2.4.2

Setting parameter

<value> ::= <INT>

<INT> → Register setting value: 0 to 255

Query parameter

None

Response format

<INT>

Setting example

*ESE 8

Query example

*ESE?

Response example

8

4.2.1.5 Common Command (IEEE488.2): Get Standard Event Status Register

*ESR?

Description

Gets the standard event status register

For the standard event status register, see **2.2.4.1**

Query parameter

None

Response format

<INT>

Query example

*ESR?

Response example

8

4.2.1.6 Common Command (IEEE488.2): Set/Get Service Request Enable Register

*SRE

Description

Sets/gets the service request enable register

For the service request enable register, see **2.2.3**

Setting parameter

<value> ::= <INT>

<INT> → Register setting value: 0 to 255

Query parameter

None

Response format

<INT>

Setting example

*SRE 8

Query example

*SRE?

Response example

8

4.2.1.7 Common Command (IEEE488.2): Get Status Byte Register

*STB?

Description

Gets the status byte register

For the status byte register, see **2.2.2**

Query parameter

None

Response format

<INT>

Query example

*STB?

Response example

8

4.2.1.8 Common Command (IEEE488.2): Wait for Synchronization of Overlap Command

*WAI

Description

Waits for completion of all the previous commands

Overlap commands return the control without waiting for the completion.

This command is accepted in the main unit and does not return the control before all the running commands (including ones other than the overlap commands) are completed.

Setting parameter

None

Setting example

*WAI

Remarks

The overlap commands include:

:OUTPut[:STATe]

[:SOURce]:VOLTage:RANGe

:MEASure:CO₂:TOTal:CLEar

:SYSTem:WRELease

:TRACe|DATA:CSINe:STORe

:TRACe|DATA:SEQuence:CLEar

:TRACe|DATA:SEQuence:NAME

:TRACe|DATA:SEQuence:RECall

:TRACe|DATA:SEQuence:STORe

:TRACe|DATA:SIMulation:CLEar

:TRACe|DATA:SIMulation:NAME

:TRACe|DATA:SIMulation:RECall

:TRACe|DATA:SIMulation:STORe

:TRACe|DATA:WAVe:CLEar

:TRACe|DATA:WAVe[:DATA]

:TRACe|DATA:WAVe:NAME

*RCL

*SAV

4.2.1.9 Common Command (IEEE488.2): Set OPC Bit at Operation Completion

*OPC

Description

Sets the OPC bit to 1 when all the previous commands are completed

For the OPC bit, see **2.2.4.1**

Setting parameter

None

Setting example

*OPC

4.2.1.10 Common Command (IEEE488.2): Get Operation Completion State

*OPC?

Description

Sets the output buffer to 1 when all the previous commands are completed

Query parameter

None

Response format

<INT>

Query example

*OPC?

Response example

1

4.2.1.11 Operate System Lock Condition Register: System Lock Condition Register
:STATus:LOCK:CONDition?**Description**

Gets the System Lock condition register

For the System Lock condition register, see **2.2.7.1**

Query parameter

None

Response format

<INT>

Query example

STAT:LOCK:COND?

Response example

1

4.2.1.12 Operate System Lock Condition Register: System Lock Event Enable Register
:STATus:LOCK:ENABLe**Description**

Sets/gets the System Lock event enable register

For the System Lock event enable register, see **2.2.7.4**

Setting parameter

<value> ::= <INT>

<INT> → Register setting value: 0 to 65535

Query parameter

None

Response format

<INT>

Setting example

STAT:LOCK:ENAB 1

Query example

STAT:LOCK:ENAB?

Response example

1

4.2.1.13 Operate System Lock Condition Register: System Lock Event Register`:STATus:LOCK[:EVENT]?`**Description**

Gets the System Lock event register

For the System Lock event register, see [2.2.7.3](#)

Query parameter

None

Response format

<INT>

Query example

STAT:LOCK?

Response example

16384

4.2.1.14 Operate System Lock Condition Register: System Lock Transition Filter (Negative)`:STATus:LOCK:NTRansition`**Description**

Sets/gets the System Lock transition filter (negative)

For the System Lock transition filter, see [2.2.7.2](#)

Setting parameter

<value> ::= <INT>

<INT> → Register setting value: 0 to 65535

Query parameter

None

Response format

<INT>

Setting example

STAT:LOCK:NTR 16384

Query example

STAT:LOCK:NTR?

Response example

16384

4.2.1.15 Operate System Lock Condition Register: System Lock Transition Filter (Positive)

:STATus:LOCK:PTRansition

Description

Set/get the System Lock transition filter (positive)

For the System Lock transition filter, see **2.2.7.2**

Setting parameter

<value> ::= <INT>

<INT> → Register setting value: 0 to 65535

Query parameter

None

Response format

<INT>

Setting example

STAT:LOCK:PTR 16384

Query example

STAT:LOCK:PTR?

Response example

16384

4.2.1.16 Operate Operation Condition Register: Operation Condition Register

:STATus:OPERation:CONDition?

Description

Gets the operation condition register

For the operation condition register, see **2.2.5.1**

Query parameter

None

Response format

<INT>

Query example

STAT:OPER:COND?

Response example

16384

4.2.1.17 Operate Operation Condition Register: Operation Event Enable Register

:STATus:OPERation:ENABle

Description

Sets/gets the operation event enable register

For the operation event enable register, see [2.2.5.4](#)

Setting parameter

<value> ::= <INT>

<INT> → Register setting value: 0 to 65535

Query parameter

None

Response format

<INT>

Setting example

STAT:OPER:ENAB 16384

Query example

STAT:OPER:ENAB?

Response example

16384

4.2.1.18 Operate Operation Condition Register: Operation Event Register

:STATus:OPERation[:EVENT]?

Description

Gets the operation event register

For the operation event register, see [2.2.5.3](#)

Query parameter

None

Response format

<INT>

Query example

STAT:OPER?

Response example

16384

4.2.1.19 Operate Operation Condition Register: Operation Transition Filter (Negative)

:STATus:OPERation:NTRansition

Description

Sets/gets the operation transition filter (negative)

For the operation transition filter, see **2.2.5.2**

Setting parameter

<value> ::= <INT>

<INT> → Register setting value: 0 to 65535

Query parameter

None

Response format

<INT>

Setting example

STAT:OPER:NTR 16384

Query example

STAT:OPER:NTR?

Response example

16384

4.2.1.20 Operate Operation Condition Register: Operation Transition Filter (Positive)

:STATus:OPERation:PTRansition

Description

Sets/gets the operation transition filter (positive)

For the operation transition filter, see 2.2.5.2

Setting parameter

<value> ::= <INT>

<INT> → Register setting value: 0 to 65535

Query parameter

None

Response format

<INT>

Setting example

STAT:OPER:PTR 16384

Query example

STAT:OPER:PTR?

Response example

16384

4.2.1.21 Get Error Message: Get Error Message

:SYSTem:ERRor?

Description

Gets the error queue output

It returns the error ID and the error message in the order

Query parameter

None

Response format

<INT>,<STR>

Query example

SYST:ERR?

Response example

0,"No error"

4.2.1.22 Operate Warning Condition Register: Get Warning Condition Register
:STATus:WARNing:CONDition?**Description**

Gets the warning condition register

For the warning condition register, see **2.2.6.1**

Query parameter

None

Response format

<INT>

Query example

STAT:WARN:COND?

Response example

16384

4.2.1.23 Operate Warning Condition Register: Set/Get Warning Event Enable Register
:STATus:WARNing:ENABLE**Description**

Sets/gets the warning event enable register

For the warning event enable register, see **2.2.6.4**

Setting parameter

<value> ::= <INT>

<INT> → Register setting value: 0 to 65535

Query parameter

None

Response format

<INT>

Setting example

STAT:WARN:ENAB 16384

Query example

STAT:WARN:ENAB?

Response example

16384

4.2.1.24 Operate Warning Condition Register: Get Warning Event Register`:STATus:WARNing[:EVENTt]?`**Description**

Gets the warning event register

For the warning event register, see **2.2.6.3**

Query parameter

None

Response format

<INT>

Query example

STAT:WARN?

Response example

16384

4.2.1.25 Operate Warning Condition Register: Set/Get Warning Transition Filter (Negative)`:STATus:WARNing:NTRansition`**Description**

Sets/gets the warning transition filter (negative)

For the warning transition filter, see **2.2.6.2**

Setting parameter

<value> ::= <INT>

<INT> → Register setting value: 0 to 65535

Query parameter

None

Response format

<INT>

Setting example

STAT:WARN:NTR 16384

Query example

STAT:WARN:NTR?

Response example

16384

4.2.1.26 Operate Warning Condition Register: Set/Get Warning Transition Filter (Positive)

:STATus:WARNing:PTRansition

Description

Sets/gets the warning transition filter (positive)

For the warning transition filter, see 2.2.6.2

Setting parameter

<value> ::= <INT>

<INT> → Register setting value: 0 to 65535

Query parameter

None

Response format

<INT>

Setting example

STAT:WARN:PTR 16384

Query example

STAT:WARN:PTR?

Response example

16384

4.2.1.27 Operate Warning Condition Register: Release Warning

:SYSTem:WRELease

Description

Sets the release of the warning

Setting parameter

None

Setting example

SYST:WREL

Remarks

The setting is ignored during the System Lock.

4.2.1.28 Output Control: Output On/Off

:OUTPut[:STATe]

Description

Sets/gets the output on/off

Setting parameter

<state> ::= <BOL>

<BOL> → 0/OFF: Disable, 1/ON: Enable

Query parameter

None

Response format

<NBOL>

Setting example

OUTP ON

Query example

OUTP?

Response example

1

Remarks

The setting is ignored during the System Lock/warning.

The response message to the query is not returned during the System Lock.

4.2.1.29 Output Control: Output at Power-On

:OUTPut:PON

Description

Sets/gets the output at power-on

Setting parameter

<state> ::= <BOL>

<BOL> → 0/OFF: Disable, 1/ON: Enable

Query parameter

None

Response format

<NBOL>

Setting example

OUTP:PON ON

Query example

OUTP:PON?

Response example

1

Remarks

The setting is ignored during the System Lock/warning.

The response message to the query is not returned during the System Lock.

4.2.1.30 Output Control: Output Relay Control

:OUTPut:RELAy

Description

Sets/gets the output relay control

Setting parameter

<state> ::= <BOL>

<BOL> → 0/OFF: Disable, 1/ON: Enable

Query parameter

None

Response format

<NBOL>

Setting example

OUTP:REL ON

Query example

OUTP:REL?

Response example

1

Remarks

The setting is ignored during the System Lock/warning.

The response message to the query is not returned during the System Lock.

4.2.1.31 Output Control: Trigger Output Polarity

:TRIGger:POLarity

Description

Sets/gets the trigger output polarity

Setting parameter

<trig slope> ::= <DISC>

<DISC> ::= POSitive | NEGative

POSitive → Rising

NEGative → Falling

Query parameter

None

Response format

None

Setting example

TRIG:POL POSITIVE

Query example

TRIG:POL?

Response example

POS

Remarks

The setting is ignored during the System Lock/warning.

The response message to the query is not returned during the System Lock.

4.2.1.32 Output Control: Trigger Output Pulse Width

:TRIGger:WIDTh

Description

Sets/gets the trigger output pulse width

The unit is millisecond (ms)

Setting parameter

<trig width> | MINimum | MAXimum

<trig width> ::= <REAL>

<REAL> → Trigger output pulse width: 0.1 to 10.0, Resolution 0.1

MINimum → 0.1

MAXimum → 10.0

Query parameter

[MINimum | MAXimum]

MINimum → Gets the minimum value

MAXimum → Gets the maximum value

Response format

<NR2>

Setting example

TRIG:WIDT 0.5

Query example

TRIG:WIDT?

Response example

0.5

Remarks

The setting is ignored during the System Lock/warning.

The response message to the query is not returned during the System Lock.

4.2.1.33 Device Configuration: Get Phase Configuration

:SYSTem:CONFigure:PHASe?

Description

Gets the phase configuration

Query parameter

None

Response format

<INT> → 0: single-phase, 1: single-phase three-wire, 2: three-phase

Query example

SYST:CONF:PHAS?

Response example

0

Remarks

The response message to the query is not returned during the System Lock.

4.2.1.34 Device Configuration: Output Function

:SYSTem:CONFigure[:MODE]

Description

Sets/gets the output function

Setting parameter

<system mode> ::= <DISC>

<DISC> ::= CONTInuous | SEQuence | SIMulation

CONTInuous → Continuous

SEQuence → Sequence

SIMulation → Simulation

Query parameter

None

Response format

<DISC>

Setting example

SYST:CONF SIMULATION

Query example

SYST:CONF?

Response example

SIM

Remarks

The setting is ignored during the System Lock/warning.

The response message to the query is not returned during the System Lock.

The setting cannot be done during the output on.

The setting cannot be done in the Sequence control state or Simulation control state.

4.2.1.35 Set Panel Display Operation: LCD Contrast Adjustment Value

:DISPlay:CONTRast

Description

Sets/gets the LCD contrast

Setting parameter

<contrast> | MINimum | MAXimum

<contrast> ::= <INT>

<INT> → LCD contrast: 0 to 99

MINimum → 0

MAXimum → 99

Query parameter

[MINimum | MAXimum]

MINimum → Gets the minimum value

MAXimum → Gets the maximum value

Response format

<INT>

Setting example

DISP:CONT 55

Query example

DISP:CONT?

Response example

55

Remarks

The setting is ignored during the System Lock/warning.

The response message to the query is not returned during the System Lock.

4.2.1.36 Set Panel Display Operation: LCD Display Color

:DISPlay[:WINDow]:BACKground:COLor

Description

Sets/gets the LCD display color

Setting parameter

<background color> ::= <DISC>

<DISC> ::= BLUE | WHITe

BLUE → Blue tone

WHITe → White tone

Query parameter

None

Response format

<DISC>

Setting example

DISP:BACK:COL WHIT

Query example

DISP:BACK:COL?

Response example

WHIT

Remarks

The setting is ignored during the System Lock/warning.

The response message to the query is not returned during the System Lock.

4.2.1.37 Set Panel Display Operation: Key Lock

:SYSTem:KLOCK

Description

Sets/gets the key lock

Setting parameter

<state> ::= <BOL>

<BOL> → 0/OFF: Disable, 1/ON: Enable

Query parameter

None

Response format

<NBOL>

Setting example

SYST:KLOC ON

Query example

SYST:KLOC?

Response example

1

Remarks

The setting is ignored during the System Lock/warning.

The response message to the query is not returned during the System Lock.

4.2.1.38 Set Panel Display Operation: Beep

:SYSTem:BEEPer:STATe

Description

Sets/gets the beep

Setting parameter

<state> ::= <BOL>

<BOL> → 0/OFF: Disable, 1/ON: Enable

Query parameter

None

Response format

<NBOL>

Setting example

SYST:BEEP:STAT ON

Query example

SYST:BEEP:STAT?

Response example

1

Remarks

The setting is ignored during the System Lock/warning.

The response message to the query is not returned during the System Lock.

4.2.1.39 Get State of Power Unit: Get Number of Connected Power Units

:SYSTem:CONFigure:NPU[:STATe]?

Description

Gets the number of connected power units

It gets the number of connected power units for the L1, L2, and L3 phases.

The status of each phase is assigned for each bit as follows:

Bit	Weight	Description
1	2	Power unit No.2 connected
0	1	Power unit No.1 connected

Query parameter

None

Response format

<INT>,<INT>,<INT>

The response for the three phases is returned regardless of the phase configuration.

0 is returned to a missing phase.

Query example

SYST:CONF:NPU?

Response example

1,2,1 (L1 phase: No.1 connected, L2 phase: No.2 connected, L3 phase: No.1 connected)

Remarks

The response message to the query is not returned during the System Lock.

4.2.1.40 Get State of Power Unit: Get Number of Energizations

:SYSTem:CONFigure:NPU:ENABle?

Description

Gets the operating power unit

It gets the power unit energization setting for the L1, L2, and L3 phases.

The status of each phase is assigned for each bit as follows:

Bit	Weight	Description
1	2	Power unit No.2 power on
0	1	Power unit No.1 power on

Query parameter

None

Response format

<INT>,<INT>,<INT>

The response for the three phases is returned regardless of the phase configuration.

0 is returned to a missing phase.

Query example

SYST:CONF:NPU:ENAB?

Response example

3,0,0 (in the single-phase, L1 phase: No.1,2 operating)

3,3,0 (in the single-phase three-wire, L1 phase: No.1,2 and L2 phase: No.1,2 operating)

3,3,3 (in the three-phase, L1 phase: No.1,2, L2 phase: No.1,2, and L3 phase: No.1,2 operating)

Remarks

The response message to the query is not returned during the System Lock.

4.2.1.41 Get State of Power Unit: Get Error State

:SYSTem:CONFigure:NPU:ERRor?

Description

Gets the power unit in which an error occurs

It gets the power unit in which an error occurs from the L1, L2, and L3 phases.

The status of each phase is assigned for each bit as follows:

If an error occurs in a power unit, the corresponding bit returns 1.

Bit	Weight	Description
1	2	Power unit No.2 error
0	1	Power unit No.1 error

Query parameter

None

Response format

<INT>,<INT>,<INT>

The response for the three phases is returned regardless of the phase configuration.

0 is returned to a missing phase.

Query example

SYST:CONF:NPU:ERR?

Response example

0,1,3 (L1 phase: no error, L2 phase: No.1 error, L3 phase: No.1,2 errors)

Remarks

The response message to the query is not returned during the System Lock.

4.2.1.42 Set Monitor Output: Monitor Output

:OUTPut:MONitor:MODE

Description

Sets/gets the monitor output

Setting parameter

<state> ::= <DISC>

<DISC> ::= CURRent | VOLTage

CURRent → Current monitor output mode

VOLTage → Voltage monitor output mode

Query parameter

None

Response format

<DISC>

Setting example

OUTP:MON:MODE CURR

Query example

OUTP:MON:MODE?

Response example

CURR

Remarks

The setting is ignored during the System Lock/warning.

The response message to the query is not returned during the System Lock.

4.2.1.43 Set Monitor Output: Specify Output Phase (Phase Number)

:OUTPut:INSTrument:NSElect

Description

Sets/gets the monitor output phase setting (phase number)

Setting parameter

<phase number> | MINimum | MAXimum

<phase number> ::= <INT>

<INT> → Phase number: 0 to 2

0: L1 phase | 1: L2 phase | 2: L3 phase

MINimum → 0

MAXimum → 2

Query parameter

[MINimum | MAXimum]

MINimum → Gets the minimum value

MAXimum → Gets the maximum value

Response format

<INT>

Setting example

OUTP:INST:NSEL 1

Query example

OUTP:INST:NSEL?

Response example

1

Remarks

The setting is ignored during the System Lock/warning.

The response message to the query is not returned during the System Lock.

4.2.1.44 Set Monitor Output: Specify Output Phase (Phase)

:OUTPut:INSTrument:SELect

Description

Sets/gets the monitor output phase setting (phase)

Setting parameter

<phase name> ::= <DISC>

<DISC> ::= L1 | L2 | L3

L1 → L1 phase, L2 → L2 phase, L3 → L3 phase

Query parameter

None

Response format

<DISC>

Setting example

OUTP:INST:SEL L1

Query example

OUTP:INST:SEL?

Response example

L1

Remarks

The setting is ignored during the System Lock/warning.

The response message to the query is not returned during the System Lock.

4.2.2 Continuous Function Commands

4.2.2.1 Common Command (IEEE488.2): Initialize Basic Setting

*RST

Description

Initializes the setting

Setting parameter

None

Setting example

*RST

Remarks

The command is ignored during the System Lock/warning.

The operation cannot be done in the Sequence control state or Simulation control state.

The operation cannot be done during the output on.

4.2.2.2 Common Command (IEEE488.2): Select and Set Basic Setting

*RCL

Description

Recalls from the setting memory

Setting parameter

<memory> ::= <INT>

<INT> →Basic Setting Memory number: 0-30

Setting example

* RCL 8

Remarks

The command is ignored during the System Lock/warning.

The operation cannot be done in the Sequence control state or Simulation control state.

The operation cannot be done during the output on.

4.2.2.3 Common Command (IEEE488.2): Store Basic Setting

*SAV

Description

Stores to the setting memory

Setting parameter

<memory> ::= <INT>

<INT> → Basic Setting Memory number: 1 to 30

Setting example

*SAV 8

Remarks

The command is ignored during the System Lock/warning.

The operation cannot be done in the Sequence control state or Simulation control state.

The operation cannot be done during the output on.

4.2.2.4 Panel Display Setting: Set/Get Normal View/Simple View Mode

:DISPlay[:WINDow]:DESign:MODE

Description

Sets/gets the Normal View/Simple View selection

Setting parameter

<design mode> ::= <DISC>

<DISC> ::= NORMAl | SIMPlE

NORMAl → Normal View

SIMPlE → Simple View

Query parameter

None

Response format

<DISC>

Setting example

DISP:DES:MODE NORM

Query example

DISP:DES:MODE?

Response example

NORM

Remarks

The setting is ignored during the System Lock/warning.

The response message to the query is not returned during the System Lock.

4.2.2.5 Panel Display Setting: Set/Get Display Items at Simple View

:DISPlay[:WINDow]:DESIgn:SIMPle:ITEM

Description

Set/get the display items at Simple View

Setting parameter

{<no> | MINimum | MAXimum},<item>

<no> ::= <INT>

<INT> ::= Item number: 1 to 3

MINimum → 1

MAXimum → 3

<item> ::= <DISC>

<DISC> ::= V | I | VAVE | IAVE | VMAX | VMIN | IMAX | IMIN | IPKH |
F | P | S | Q | PF | CF

V → Voltage effective value

(can be set when RMS is selected for the measurement display)

I → Current effective value (can be set when RMS is selected for the measurement display)

VAVE → Voltage average value (can be set when AVG is selected for the measurement display)
(cannot be set at polyphase)IAVE → Current average value (can be set when AVG is selected for the measurement display)
(cannot be set at polyphase)VMAX → Voltage maximum peak value
(can be set when PEAK is selected for the measurement display)VMIN → Voltage minimum peak value
(can be set when PEAK is selected for the measurement display)IMAX → Current maximum peak value
(can be set when PEAK is selected for the measurement display)IMIN → Current minimum peak value
(can be set when PEAK is selected for the measurement display)

IPKH → Output Current Peak-Hold Value

F → AC frequency (can be set at SYNC mode)

P → Active power

S → Apparent power (can be set at AC or ACDC mode)

Q → Reactive power (can be set at AC or ACDC mode)

- PF → Load power factor (can be set at AC or ACDC mode)
- CF → Load crest factor
(can be set at AC or ACDC mode)

Query parameter

<no> | MINimum | MAXimum

<no> ::= <INT>

<INT> ::= Item number: 1 to 3

MINimum → 1

MAXimum → 3

Response format

<DISC>

Setting example

DISP:DES:SIMP:ITEM 1,V

Query example

DISP:DES:MODE? 1

Response example

V

Remarks

The setting is ignored during the System Lock/warning.

The response message to the query is not returned during the System Lock.

4.2.2.6 Panel Display Setting: Measurement Display Phase Setting (Phase Number)

:DISPlay[:WINDow]:INSTrument:NSElect

Description

Sets/gets the measurement display phase setting (phase number)

Switches the measurement display phase displayed in the LCD

Setting parameter

<phase number> | MINimum | MAXimum

<phase number> ::= <INT>

<INT> → Phase number: 0 to 5

0: L1 phase | 1: L2 phase | 2: L3 phase |

3: L1-L2 line | 4: L2-L3 line | 5: L3-L1 line

MINimum → 0

MAXimum → 5

Query parameter

[MINimum | MAXimum]

MINimum → Gets the minimum value

MAXimum → Gets the maximum value

Response format

<INT>

Setting example

DISP:INST:NSEL 1

Query example

DISP:INST:NSEL?

Response example

1

Remarks

The setting is ignored during the System Lock/warning.

The response message to the query is not returned during the System Lock.

For single-phase, only 0 can be set.

For single-phase three-wire, 0, 1, and 3 can be set.

4.2.2.7 Panel Display Setting: Measurement Display Phase Setting (Phase)

:DISPlay[:WINDow]:INSTrument:SElect

Description

Sets/gets the measurement display phase setting (phase)

Switches the measurement phase displayed in the LCD

Setting parameter

<phase name> ::= <DISC>

<DISC> ::= L1 | L2 | L3 | L12 | L23 | L31

L1	→ L1 phase
L2	→ L2 phase
L3	→ L3 phase
L12	→ L1-L2 line
L23	→ L2-L3 line
L31	→ L3-L1 line

Query parameter

None

Response format

<DISC>

Setting example

DISP:INST:SEL L1

Query example

DISP:INST:SEL?

Response example

L1

Remarks

The setting is ignored during the System Lock/warning.

The response message to the query is not returned during the System Lock.

For single-phase, only L1 can be set.

For single-phase three-wire, L1, L2, and L12 can be set.

4.2.2.8 Panel Display Setting: Set/Get Measurement Display Selection

:DISPlay[:WINDow]:MEASure:MODE

Description

Sets/gets the measurement display selection

It sets the measurement phase displayed during the Continuous, Sequence control, and Simulation control.

Setting parameter

<disp meas mode> ::= <DISC>

<DISC> ::= RMS | AVG | PEAK | HC1 | HC2 | HC3 | HC4

RMS → Effective value

AVG → Average value

PEAK → Peak value

HC1 → Harmonic current 1

HC2 → Harmonic current 2

HC3 → Harmonic current 3

HC4 → Harmonic current 4

Query parameter

None

Response format

<DISC>

Setting example

DISP:MEAS:MODE RMS

Query example

DISP:MEAS:MODE?

Response example

RMS

Remarks

The setting is ignored during the System Lock/warning.

The response message to the query is not returned during the System Lock.

The harmonic currents 1 to 4 can be set at the Continuous.

4.2.2.9 Output Setting (for All Phases): Set/Get Output Range

[:SOURce]:VOLTage:RANGe

Description

Set/get the output range

Setting parameter

<volt range> ::= <DISC>

<DISC> ::= R100V | R200V

R100V → 100V range

R200V → 200V range

Query parameter

None

Response format

<DISC>

Setting example

VOLT:RANG R100V

Query example

VOLT:RANG?

Response example

R100V

Remarks

The setting is ignored during the System Lock/warning.

The response message to the query is not returned during the System Lock.

The setting cannot be done in the Sequence control state or Simulation control state.

The setting cannot be done during the output on.

4.2.2.10 Output Setting (for All Phases): Set Operation Mode

[[:SOURce]:]MODE

Description

Sets/gets the operation mode

Setting parameter

<mode> ::= <DISC>

<DISC> ::= AC_INT | AC_VCA | AC_SYNC | AC_EXT | AC_ADD |
 DC_INT | DC_VCA | DC_EXT | AC_ADD |
 ACDC_INT | ACDC_SYNC | ACDC_EXT | ACDC_ADD

AC_INT → AC-INT mode

AC_VCA → AC-VCA mode

AC_SYNC → AC-SYNC mode

AC_EXT → AC-EXT mode

AC_ADD → AC-ADD mode

DC_INT → DC-INT mode

DC_VCA → DC-VCA mode

ACDC_INT → ACDC-INT mode

ACDC_SYNC → ACDC-SYNC mode

ACDC_EXT → ACDC-EXT mode

ACDC_ADD → ACDC-ADD mode

The following table describes which operation mode can be set for each system.

AC/DC mode	Signal source	Single-phase	Polyphase connection
AC	INT	○	○
	VCA	○	○
	SYNC	○	○
	EXT	○	×
	ADD	○	×
DC	INT	○	×
	VCA	○	×
	SYNC	×	×
	EXT	×	×
	ADD	×	×
ACDC	INT	○	○
	VCA	×	×
	SYNC	○	○
	EXT	○	×
	ADD	○	×

○: Can be set, ×: Cannot be set

Query parameter

None

Response format

<DISC>

Setting example

MODE ACDC_INT

Query example

MODE?

Response example

ACDC_INT

Remarks

The setting is ignored during the System Lock/warning.

The response message to the query is not returned during the System Lock.

When the output function is the Sequence, only INT can be selected as the signal source.

When the output function is the Simulation, only the ACDC-INT mode can be selected as the operation mode.

4.2.2.11 Output Setting (for All Phases): Set/Get Output Frequency

[:SOURce]:FREQuency[:IMMediate]

Description

Sets/gets the output frequency

Setting parameter

<frequency> | MINimum | MAXimum

<frequency> ::= <REAL>

<REAL> → Frequency: 40.00 (AC-INT)/1.00 (other than AC-INT) to 550.00, Resolution 0.01

MINimum → 40.00 (AC-INT)/1.00 (other than AC-INT)

MAXimum → 550.00

Query parameter

[MINimum | MAXimum]

MINimum → Gets the minimum value

MAXimum → Gets the maximum value

Response format

<NR2>

Setting example

FREQ 50

Query example

FREQ?

Response example

50.0

Remarks

The setting is ignored during the System Lock/warning.

The response message to the query is not returned during the System Lock.

The setting cannot be done in the Sequence and Simulation.

The setting can be made only in the AC-INT, AC-VCA, AC-ADD, ACDC-INT, and ACDC-ADD modes.

4.2.2.12 Output Setting (for All Phases): Set Output On Phase

[[:SOURce]:PHASe:STARt[:IMMediate]

Description

Sets/gets the output on phase

Setting parameter

<phase> | MINimum | MAXimum

<phase> ::= <REAL>

<REAL> → Phase: 0.0 to 359.9, Resolution 0.1

MINimum → 0.0

MAXimum → 359.9

Query parameter

[MINimum | MAXimum]

MINimum → Gets the minimum value

MAXimum → Gets the maximum value

Response format

<NR2>

Setting example

PHAS:STAR 90

Query example

PHAS:STAR?

Response example

90.0

Remarks

The setting is ignored during the System Lock/warning.

The response message to the query is not returned during the System Lock.

The setting cannot be done in the Sequence and Simulation.

The setting cannot be done in the AC-EXT, ACDC-EXT, DC-INT, and DC-VCA modes.

4.2.2.13 Output Setting (for All Phases): Enable/Disable Output Off Phase Specification

[[:SOURce]:PHASe:STOP:ENABle

Description

Sets/gets whether to enable/disable the output off phase

Setting parameter

<state> ::= <BOL>

<BOL> → 0/OFF: Disable, 1/ON: Enable

Query parameter

None

Response format

<NBOL>

Setting example

PHAS:STOP:ENAB ON

Query example

PHAS:STOP:ENAB?

Response example

1

Remarks

The setting is ignored during the System Lock/warning.

The response message to the query is not returned during the System Lock.

The setting cannot be done in the Sequence and Simulation.

The setting cannot be done in the AC-EXT, ACDC-EXT, DC-INT, and DC-VCA modes.

4.2.2.14 Output Setting (for All Phases): Set Output Off Phase

[:SOURce]:PHASe:STOP[:IMMEDIATE]

Description

Sets/gets the output off phase

Setting parameter

<phase> | MINimum | MAXimum

<phase> ::= <REAL>

<REAL> → Phase: 0.0 to 359.9, Resolution 0.1

MINimum → 0.0

MAXimum → 359.9

Query parameter

[MINimum | MAXimum]

MINimum → Gets the minimum value

MAXimum → Gets the maximum value

Response format

<NR2>

Setting example

PHAS:STOP 90

Query example

PHAS:STOP?

Response example

90.0

Remarks

The setting is ignored during the System Lock/warning.

The response message to the query is not returned during the System Lock.

The setting cannot be done in the Sequence and Simulation.

The setting cannot be done in the AC-EXT, ACDC-EXT, DC-INT, and DC-VCA modes.

4.2.2.15 Output Setting (for All Phases): Set/Get Balanced/Unbalanced Mode

[:SOURce]:PHASe:MODE

Description

Sets/gets the balanced mode

Setting parameter

<mode> ::= <DISC>

BALance → Balanced mode

UNBalance → Unbalanced mode

Query parameter

None

Response format

<DISC>

Setting example

PHAS:MODE BAL

Query example

PHAS:MODE?

Response example

BAL

Remarks

The setting is ignored during the System Lock/warning.

The response message to the query is not returned during the System Lock.

The setting cannot be done in the single-phase.

4.2.2.16 Output Setting (for All Phases): Set Remote Sensing Function`:MEASure:CONFigure:SENSing`**Description**

Sets/gets the remote sensing

Setting parameter

`<state> ::= <BOL>`

`<BOL>` → 0/OFF: Disable, 1/ON: Enable

Query parameter

None

Response format

`<NBOL>`

Setting example

`MEAS:CONF:SENS ON`

Query example

`MEAS:CONF:SENS?`

Response example

1

Remarks

The setting is ignored during the System Lock/warning.

The response message to the query is not returned during the System Lock.

The remote sensing can be set only when the waveform is a sine wave for the AC mode in the AC-INT, AC-VCA, AC-SYNC, DC-INT, and DC-VCA modes.

When the Sequence or Simulation function is selected, the remote sensing is forcibly set to off.

4.2.2.17 Output Setting (for Specific Phase): Specify Phase To Set (Phase Number)

:INSTrument:NSELect

Description

Sets/gets the output phase setting (phase number)

It specifies the phase to set/get by the SOURce subsystem command.

It does not affect the phase specification by the SOURce:SEQuence subsystem.

Setting parameter

<phase number> | MINimum | MAXimum

<phase number> ::= <INT>

<INT> → Phase number: 0 to 4

0: All phases at once | 1: L1 phase | 2: L2 phase | 3: L3 phase | 4: Line

MINimum → 0

MAXimum → 4

Query parameter

[MINimum | MAXimum]

MINimum → Gets the minimum value

MAXimum → Gets the maximum value

Response format

<INT>

Setting example

INST:NSEL 1

Query example

INST:NSEL?

Response example

1

Remarks

The setting is ignored during the System Lock/warning.

The response message to the query is not returned during the System Lock.

For single-phase, only 0 and 1 can be set.

For single-phase three-wire, 0, 1, 2, and 4 can be set.

4.2.2.18 Output Setting (for Specific Phase): Specify Phase To Set (Phase)

:INSTrument:SELect

Description

Sets/gets the output phase setting (phase)

It specifies the phase to set/get by the SOURce subsystem command.

It does not affect the phase specification by the SOURce:SEQUence subsystem.

Setting parameter

<phase name> ::= <DISC>

<DISC> ::= ALL | L1 | L2 | L3 | LINE

ALL → All phases at once

L1 → L1 phase, L2 → L2 phase, L3 → L3 phase

LINE → Line

Query parameter

None

Response format

<DISC>

Setting example

INST:SEL L1

Query example

INST:SEL?

Response example

L1

Remarks

The setting is ignored during the System Lock/warning.

The response message to the query is not returned during the System Lock.

For single-phase, only ALL and L1 can be set.

For single-phase three-wire, ALL, L1, L2, and LINE can be set.

4.2.2.19 Output Setting (for Specific Phase): Set/Get AC Output Voltage

[:SOURce]:VOLTage[:LEVel][:IMMEdiate][:AMPLitude]

Description

Sets/gets the AC output voltage

Setting parameter

<volt> | MINimum | MAXimum

<volt> ::= <REAL>

<REAL> → AC output voltage

MINimum → Minimum value

MAXimum → Maximum value

For the setting value range, maximum value, minimum value, and resolution, see the instruction manual of the main unit.

Query parameter

[MINimum | MAXimum]

MINimum → Gets the minimum value

MAXimum → Gets the maximum value

Response format

<NR2>

Setting example

VOLT 100

Query example

VOLT?

Response example

100.0

Remarks

The setting is ignored during the System Lock/warning.

The response message to the query is not returned during the System Lock.

The setting cannot be done in the Sequence and Simulation.

4.2.2.20 Output Setting (for Specific Phase): Set/Get DC Output Voltage

[:SOURce]:VOLTage[:LEVel][:IMMEdiate]:OFFSet

Description

Sets/gets the DC output voltage

Setting parameter

<volt offs> | MINimum | MAXimum

<volt offs> ::= <REAL>

<REAL> → DC output voltage

MINimum → Minimum value

MAXimum → Maximum value

For the setting value range, maximum value, minimum value, and resolution, see the instruction manual of the main unit.

Query parameter

[MINimum | MAXimum]

MINimum → Gets the minimum value

MAXimum → Gets the maximum value

Response format

<NR2>

Setting example

VOLT:OFFS 10

Query example

VOLT:OFFS?

Response example

10.0

Remarks

The setting is ignored during the System Lock/warning.

The response message to the query is not returned during the System Lock.

The setting cannot be done in the Sequence and Simulation.

4.2.2.21 Output Setting (for Specific Phase): Select Output Waveform

[:SOURce]:FUNCtion[:SHAPE][:IMMediate]

Description

Sets/gets the output waveform

Setting parameter

<func shap> ::= <DISC>

<DISC> ::= SIN | ARB1 | ARB2 | ARB3 | ARB4 | ARB5 | ARB6 | ARB7 | ARB8 |
 ARB9 | ARB10 | ARB11 | ARB12 | ARB13 | ARB14 | ARB15 | ARB16 |
 CLP1 | CLP2 | CLP3

SIN → Sine wave

ARB1 → Arbitrary wave 1

:

ARB16 → Arbitrary wave 16

CLP1 → Clipped sine wave 1

CLP2 → Clipped sine wave 2

CLP3 → Clipped sine wave 3

Query parameter

None

Response format

<DISC>

Setting example

FUNC SIN

Query example

FUNC?

Response example

SIN

Remarks

The setting is ignored during the System Lock/warning.

The response message to the query is not returned during the System Lock.

The setting cannot be done in the Sequence and Simulation.

4.2.2.22 Output Setting (for Specific Phase): Set/Get Phase Angle at Polyphase System

[:SOURce]:PHASe:PHASe

Description

Sets/gets the phase angle

Setting parameter

<target>,{<phase> | MINimum | MAXimum}

<target> ::= <DISC>

L12 → Phase angle between L1-L2

L13 → Phase angle between L1-L3

<phase> ::= <REAL>

<REAL> → Phase angle: 0.0~359.9, Resolution 0.1

For the single-phase three-wire

L12 default value: 180.0deg

For the three-phase

L12 default value: 120.0 deg, L13 default value: 240.0deg

MINimum → Minimum value

MAXimum → Maximum value

Query parameter

<target> [, MINimum | MAXimum]

<target> ::= <DISC>

L12 → Phase angle between L1-L2

L13 → Phase angle between L1-L3

MINimum → Gets the minimum value

MAXimum → Gets the maximum value

Response format

<NR2>

Setting example

PHAS:PHAS L12,125

Query example

PHAS:PHAS? L12

Response example

125.0

Remarks

The setting is ignored during the System Lock/warning.

The response message to the query is not returned during the System Lock.

The setting cannot be done in the single-phase.

The phase angle between L1-L3 cannot be set in the single-phase three-wire.

4.2.2.23 Output Setting (for Specific Phase): Set DC Offset Voltage Adjustment Value (AC mode)

[:SOURce]:VOLTage:ADJ:OFFSet:AC

Description

Sets/gets the DC offset voltage adjustment value [mV] in the AC mode

Setting parameter

<adjust voltage> | MINimum | MAXimum

<adjust voltage> ::= <REAL>

<REAL> → Voltage adjustment value:-50.0 to 50.0, Resolution 0.1

MINimum → -50.0

MAXimum → 50.0

Query parameter

[MINimum | MAXimum]

MINimum → Gets the minimum value

MAXimum → Gets the maximum value

Response format

<NR2>

Setting example

VOLT:ADJ:OFFS:AC 10

Query example

VOLT:ADJ:OFFS:AC?

Response example

10.0

Remarks

The setting is ignored during the System Lock/warning.

The response message to the query is not returned during the System Lock.

4.2.2.24 Output Setting (for Specific Phase): Set DC Offset Voltage Adjustment Value (ACDC and DC modes)

[:SOURce]:VOLTage:ADJust:OFFSet:DC

Description

Sets/gets the DC offset voltage adjustment value [mV] in the ACDC and DC modes

Setting parameter

<adjust voltage> | MINimum | MAXimum

<adjust voltage> ::= <INT>

<INT> → Voltage adjustment value:-250 to 250, Resolution 1

MINimum → -250

MAXimum → 250

Query parameter

[MINimum | MAXimum]

MINimum → Gets the minimum value

MAXimum → Gets the maximum value

Response format

<INT>

Setting example

VOLT:ADJ:OFFS:DC 10

Query example

VOLT:ADJ:OFFS:DC?

Response example

10

Remarks

The setting is ignored during the System Lock/warning.

The response message to the query is not returned during the System Lock.

4.2.2.25 Set Output Voltage Limit: Voltage Limit (Effective Value)

[:SOURce]:VOLTage:LIMit:RMS

Description

Sets/gets the effective voltage setting range limit (effective value)

Setting parameter

<volt lim low> | MINimum | MAXimum

<volt lim low> ::= <REAL>

<REAL> → Voltage upper limit value

MINimum → Minimum value

MAXimum → Maximum value

For the setting value range, maximum value, minimum value, and resolution, see the instruction manual of the main unit.

Query parameter

[MINimum | MAXimum]

MINimum → Gets the minimum value

MAXimum → Gets the maximum value

Response format

<NR2>

Setting example

VOLT:LIM:RMS 100

Query example

VOLT:LIM:RMS?

Response example

100.0

Remarks

The setting is ignored during the System Lock/warning.

The response message to the query is not returned during the System Lock.

The setting cannot be done in the Sequence and Simulation.

4.2.2.26 Set Output Voltage Limit: Voltage Limit (Peak Value <Maximum>)

[:SOURce]:VOLTage:LIMit:HIGH

Description

Sets/gets the voltage setting range limit (peak value <maximum>)

Setting parameter

<volt lim high> | MINimum | MAXimum

<volt lim high> ::= <REAL>

<REAL> → Output voltage upper limit

MINimum → Minimum value

MAXimum → Maximum value

For the setting value range, maximum value, minimum value, and resolution, see the instruction manual of the main unit.

Query parameter

[MINimum | MAXimum]

MINimum → Gets the minimum value

MAXimum → Gets the maximum value

Response format

<NR2>

Setting example

VOLT:LIM:HIGH 200

Query example

VOLT:LIM:HIGH?

Response example

200.0

Remarks

The setting is ignored during the System Lock/warning.

The response message to the query is not returned during the System Lock.

The setting cannot be done in the Sequence and Simulation.

4.2.2.27 Set Output Voltage Limit: Voltage Limit (Peak Value <Minimum>)

[:SOURce]:VOLTage:LIMit:LOW

Description

Sets/gets the voltage setting range limit (peak value <minimum>)

Setting parameter

<volt lim low> | MINimum | MAXimum

<volt lim low> ::= <REAL> → Output voltage lower limit

MINimum → Minimum value

MAXimum → Maximum value

For the setting value range, maximum value, minimum value, and resolution, see the instruction manual of the main unit.

Query parameter

[MINimum | MAXimum]

MINimum → Gets the minimum value

MAXimum → Gets the maximum value

Response format

<NR2>

Setting example

VOLT:LIM:LOW -200

Query example

VOLT:LIM:LOW?

Response example

-200.0

Remarks

The setting is ignored during the System Lock/warning.

The response message to the query is not returned during the System Lock.

The setting cannot be done in the Sequence and Simulation.

4.2.2.28 Set Output Current Limit: Set Current Limit (Effective Value)

[:SOURce]:CURRent:LIMit:RMS[:AMPLitude]

Description

Sets/gets the current effective value [Arms] limiter

Setting parameter

<cur lim rms> | MINimum | MAXimum

<cur lim rms > ::= <REAL>

<REAL> → Output current effective value

MINimum → Minimum value

MAXimum → Maximum value

For the setting value range, maximum value, minimum value, and resolution, see the instruction manual of the main unit.

Query parameter

[MINimum | MAXimum]

MINimum → Gets the minimum value

MAXimum → Gets the maximum value

Response format

<NR2>

Setting example

CURR:LIM:RMS 5

Query example

CURR:LIM:RMS?

Response example

5.0

Remarks

The setting is ignored during the System Lock/warning.

The response message to the query is not returned during the System Lock.

4.2.2.29 Set Output Current Limit: Set Output OFF at Current Limit (Effective Value) Detection

[:SOURce]:CURRent:LIMit:RMS:MODE

Description

Sets/gets the output off after the RMS current limiter is activated

Setting parameter

<cur lim mode> ::= <DISC>

<DISC> ::= CONTInuous | OFF

CONTInuous → Continuous operation, output off disabled

OFF → Output off enabled

Query parameter

None

Response format

<DISC>

Setting example

CURR:LIM:RMS:MODE OFF

Query example

CURR:LIM:RMS:MODE?

Response example

OFF

Remarks

The setting is ignored during the System Lock/warning.

The response message to the query is not returned during the System Lock.

4.2.2.30 Set Output Current Limit: Set Time Before Turning Output OFF After Current Limit (Effective Value) is Detected
[:SOURce]:CURRent:LIMit:RMS:TIME

Description

Sets/gets the time [s] before turning the output off after the RMS current limiter is activated

Setting parameter

<cur lim time> | MINimum | MAXimum

<cur lim time> ::= <INT>

<INT> → Limiter time: 1 to 10

MINimum → 1

MAXimum → 10

Query parameter

[MINimum | MAXimum]

MINimum → Gets the minimum value

MAXimum → Gets the maximum value

Response format

<INT>

Setting example

CURR:LIM:RMS:TIME 5

Query example

CURR:LIM:RMS:TIME?

Response example

5

Remarks

The setting is ignored during the System Lock/warning.

The response message to the query is not returned during the System Lock.

4.2.2.31 Set Output Current Limit: Set Current Limit (Peak Value <Maximum>)

[:SOURce]:CURRent:LIMit:PEAK:HIGH

Description

Sets/gets the peak current limiter (positive) [A]

Setting parameter

<cur lim peak high> | MINimum | MAXimum

<cur lim peak high> ::= <REAL>

<REAL> → Peak current limiter (positive) setting value

MINimum → Minimum value

MAXimum → Maximum value

For the setting value range, maximum value, minimum value, and resolution, see the instruction manual of the main unit.

Query parameter

[MINimum | MAXimum]

MINimum → Gets the minimum value

MAXimum → Gets the maximum value

Response format

<NR2>

Setting example

CURR:LIM:PEAK:HIGH 10

Query example

CURR:LIM:PEAK:HIGH?

Response example

10.0

Remarks

The setting is ignored during the System Lock/warning.

The response message to the query is not returned during the System Lock.

4.2.2.32 Set Output Current Limit: Set Current Limit (Peak Value <Minimum>)

[:SOURce]:CURRent:LIMit:PEAK:LOW

Description

Sets/gets the peak current limiter (negative) [A]

Setting parameter

<cur lim peak low> | MINimum | MAXimum

<cur lim peak low> ::= <REAL>

<REAL> → Peak current limiter (negative) setting value

MINimum → Minimum value

MAXimum → Maximum value

For the setting value range, maximum value, minimum value, and resolution, see the instruction manual of the main unit.

Query parameter

[MINimum | MAXimum]

MINimum → Gets the minimum value

MAXimum → Gets the maximum value

Response format

<NR2>

Setting example

CURR:LIM:PEAK:LOW -10

Query example

CURR:LIM:PEAK:LOW?

Response example

-10.0

Remarks

The setting is ignored during the System Lock/warning.

The response message to the query is not returned during the System Lock.

4.2.2.33 Set Output Current Limit: Set Output OFF at Current Limit (Peak Value) Detection

[:SOURce]:CURRent:LIMit:PEAK:MODE

Description

Sets/gets the output off after the peak current limiter is activated

Setting parameter

<cur lim mode> ::= <DISC>

<DISC> ::= CONTInuous | OFF

CONTInuous → Continuous operation, output off disabled

OFF → Output off enabled

Query parameter

None

Response format

<DISC>

Setting example

CURR:LIM:PEAK:MODE OFF

Query example

CURR:LIM:PEAK:MODE?

Response example

OFF

Remarks

The setting is ignored during the System Lock/warning.

The response message to the query is not returned during the System Lock.

4.2.2.34 Set Output Current Limit: Time Before Turning Output OFF After Current Limit (Peak Value) is Detected
[:SOURce]:CURRent:LIMit:PEAK:TIME

Description

Sets/gets the time [s] before turning the output off after the peak current limiter is activated

Setting parameter

<cur lim time> | MINimum | MAXimum

<cur lim time> ::= <INT>

<INT> → Limiter time: 1 to 10

MINimum → 1

MAXimum → 10

Query parameter

[MINimum | MAXimum]

MINimum → Gets the minimum value

MAXimum → Gets the maximum value

Response format

<INT>

Setting example

CURR:LIM:PEAK:TIME 5

Query example

CURR:LIM:PEAK:TIME?

Response example

5

Remarks

The setting is ignored during the System Lock/warning.

The response message to the query is not returned during the System Lock.

4.2.2.35 Set Output Frequency Setting Range Limit: Set Upper Limit Value of Frequency Limit [:SOURce]:FREQuency:LIMit:HIGH

Description

Sets/gets the upper limit value [Hz] of the frequency setting range limit

Setting parameter

<frequency> | MINimum | MAXimum

<frequency> ::= <REAL>

<REAL> → Frequency: 40.00 (AC-INT)/1.00 (other than AC-INT) to 550.00, Resolution 0.01

MINimum → 40.00 (AC-INT)/1.00 (other than AC-INT)

MAXimum → 550.00

Query parameter

[MINimum | MAXimum]

MINimum → Gets the minimum value

MAXimum → Gets the maximum value

Response format

<NR2>

Setting example

FREQ:LIM:HIGH 60

Query example

FREQ:LIM:HIGH?

Response example

60.0

Remarks

The setting is ignored during the System Lock/warning.

The response message to the query is not returned during the System Lock.

The setting cannot be done in the Sequence and Simulation.

The setting can be made only in the AC-INT, AC-VCA, AC-ADD, ACDC-INT, and ACDC-ADD modes.

4.2.2.36 Set Output Frequency Setting Range Limit: Set Lower Limit Value of Frequency Limit
[:SOURce]:FREQUency:LIMit:LOW**Description**

Sets/gets the lower limit value [Hz] of the frequency setting range limit

Setting parameter

<frequency> | MINimum | MAXimum

<frequency> ::= <REAL>

<REAL> → 40.00 (AC-INT)/1.00 (other than AC-INT) to 550.00, Resolution 0.01

MINimum → 40.00 (AC-INT)/1.00 (other than AC-INT)

MAXimum → 550.00

Query parameter

[MINimum | MAXimum]

MINimum → Gets the minimum value

MAXimum → Gets the maximum value

Response format

<NR2>

Setting example

FREQ:LIM:LOW 40

Query example

FREQ:LIM:LOW?

Response example

40.0

Remarks

The setting is ignored during the System Lock/warning.

The response message to the query is not returned during the System Lock.

The setting cannot be done in the Sequence and Simulation.

The setting can be made only in the AC-INT, AC-VCA, AC-ADD, ACDC-INT, and ACDC-ADD modes.

4.2.2.37 Get Output Measured Value: Clear Current Peak-Hold Value

:MEASure[:SCALar]:CURRent:PEAK:CLEar

Description

Clears the current peak-hold value

Setting parameter

None

Setting example

MEAS:CURR:PEAK:CLE

Remarks

The setting is ignored during the System Lock/warning.

The response message to the query is not returned during the System Lock.

4.2.2.38 Get Output Measured Value: Get Current Peak-Hold Value

:MEASure[:SCALar]:CURRent:PEAK:HOLD?

Description

Gets the current peak-hold value [Apk]

Query parameter

None

Response format

<NR2>→ Query response range

For the query response range and resolution, see the instruction manual of the main unit.

Query example

MEAS:CURR:PEAK:HOLD?

Response example

26.55

Remarks

The response message to the query is not returned during the System Lock.

4.2.2.39 Get Output Measured Value: Get Synchronization Signal Source Frequency

:MEASure[:SCALar]:FREQuency?

Description

Gets the synchronization signal source frequency [Hz]

If the measured value exceeds the response range, 999.9 is returned as a measurement error

Query parameter

None

Response format

<NR2>→ Query response range

For the query response range and resolution, see the instruction manual of the main unit.

Query example

MEAS:FREQ?

Response example

50.4

Remarks

The response message to the query is not returned during the System Lock.

4.2.2.40 Get Output Measured Value (for Specific Phase): Specify Measurement Query Phase (Phase Number)

:MEASure:INSTrument:NSElect

Description

Sets/gets the measurement query phase (phase number)

It specifies the phase to query the measured value for by the MEASure subsystem command.

* This command does not affect the measured value display phase displayed in the LCD.

Setting parameter

<phase number> | MINimum | MAXimum

<phase number> ::= <INT>

<INT> → Phase number: 0 to 5

0: L1 phase | 1: L2 phase | 2: L3 phase |

3: L1-L2 line | 4: L2-L3 line | 5: L3-L1 line

MINimum → 0

MAXimum → 5

Query parameter

[MINimum | MAXimum]

MINimum → Gets the minimum value

MAXimum → Gets the maximum value

Response format

<INT>

Setting example

MEAS:INST:NSEL 1

Query example

MEAS:INST:NSEL?

Response example

1

Remarks

The setting is ignored during the System Lock/warning.

The response message to the query is not returned during the System Lock.

For single-phase, only 0 can be set.

For single-phase three-wire, 0, 1, and 3 can be set.

4.2.2.41 Get Output Measured Value (for Specific Phase): Specify Measurement Query Phase (Phase) :MEASure:INSTrument:SELect

Description

Sets/gets the measurement query phase (phase)

It specifies the phase to query the measured value for by the MEASure subsystem command.

* This command does not affect the measured value display phase displayed in the LCD.

Setting parameter

<phase name> ::= <DISC>

<DISC> ::= L1 | L2 | L3 | L12| L23| L31

L1 → L1 phase, L2 → L2 phase, L3 → L3 phase

L12 → L1-L2 line, L23 → L2-L3 line, L31 → L3-L1 line

Query parameter

None

Response format

<DISC>

Setting example

MEAS:INST:SEL L1

Query example

MEAS:INST:SEL?

Response example

L1

Remarks

The setting is ignored during the System Lock/warning.

The response message to the query is not returned during the System Lock.

For single-phase, only L1 can be set.

For single-phase three-wire, L1, L2, and L12 can be set.

4.2.2.42 Get Output Measured Value (for Specific Phase): Output Voltage (Effective Value)

:MEASure[:SCALar]:VOLTage[:RMS]?

Description

Gets the output voltage effective value [Vrms]

Query parameter

None

Response format

<NR2>→ Query response range

For the query response range and resolution, see the instruction manual of the main unit.

Query example

MEAS:VOLT?

Response example

100.4

Remarks

The response message to the query is not returned during the System Lock.

4.2.2.43 Get Output Measured Value (for Specific Phase): Output Voltage (Average Value)

:MEASure[:SCALar]:VOLTage:AVErage?

Description

Gets the output voltage average value [V]

Query parameter

None

Response format

<NR2>→ Query response range

For the query response range and resolution, see the instruction manual of the main unit.

Query example

MEAS:VOLT:AVE?

Response example

100.0

Remarks

The response message to the query is not returned during the System Lock.

The query can be made only when the measurement query phase is L1, L2, or L3.

4.2.2.44 Get Output Measured Value (for Specific Phase): Output Voltage (Peak Value <Maximum>)
:MEASure[:SCALar]:VOLTage:HIGH?

Description

Gets the voltage maximum value [Vpk]

Query parameter

None

Response format

<NR2>→ Query response range

For the query response range and resolution, see the instruction manual of the main unit.

Query example

MEAS:VOLT:HIGH?

Response example

141.4

Remarks

The response message to the query is not returned during the System Lock.

4.2.2.45 Get Output Measured Value (for Specific Phase): Output Voltage (Peak Value <Minimum>)
:MEASure[:SCALar]:VOLTage:LOW?

Description

Gets the voltage minimum value [Vpk]

Query parameter

None

Response format

<NR2>→ Query response range

For the query response range and resolution, see the instruction manual of the main unit.

Query example

MEAS:VOLT:LOW?

Response example

-141.4

Remarks

The response message to the query is not returned during the System Lock.

4.2.2.46 Get Output Measured Value (for Specific Phase): Output Current (Effective Value)`:MEASure[:SCALar]:CURRent[:RMS]?`**Description**

Gets the output current effective value [Arms]

Query parameter

None

Response format

<NR2>→ Query response range

For the query response range and resolution, see the instruction manual of the main unit.

Query example

MEAS:CURR?

Response example

12.75

Remarks

The response message to the query is not returned during the System Lock.

The query can be made only when the measurement query phase is L1, L2, or L3.

4.2.2.47 Get Output Measured Value (for Specific Phase): Output Current (Average)`:MEASure[:SCALar]:CURRent:AVErage?`**Description**

Gets the output current average value [A]

Query parameter

None

Response format

<NR2>→ Query response range

For the query response range and resolution, see the instruction manual of the main unit.

Query example

MEAS:CURR:AVE?

Response example

1.20

Remarks

The response message to the query is not returned during the System Lock.

The query can be made only when the measurement query phase is L1, L2, or L3.

4.2.2.48 Get Output Measured Value (for Specific Phase): Output Current (Peak Value <Maximum>)
:MEASure[:SCALar]:CURRent:HIGH?

Description

Gets the output current maximum peak value [Apk]

Query parameter

None

Response format

<NR2>→ Query response range

For the query response range and resolution, see the instruction manual of the main unit.

Query example

MEAS:CURR:HIGH?

Response example

30.0

Remarks

The response message to the query is not returned during the System Lock.

The query can be made only when the measurement query phase is L1, L2, or L3.

4.2.2.49 Get Output Measured Value (for Specific Phase): Output Current (Peak Value <Minimum>)
:MEASure[:SCALar]:CURRent:LOW?

Description

Gets the output current minimum peak value [Apk]

Query parameter

None

Response format

<NR2>→ Query response range

For the query response range and resolution, see the instruction manual of the main unit.

Query example

MEAS:CURR:LOW?

Response example

-30.0

4.2.2.50 Get Output Measured Value (for Specific Phase): Control Harmonic Measurement Function
:MEASure[:SCALar]:CURRent:HARMonic:ENABle**Description**

Sets/gets whether to enable/disable the harmonic measurement

Set to enable it before querying the harmonic current. You do not have to disable it after querying the harmonic current. It is automatically disabled when the harmonic measurement cannot be performed.

Setting parameter

<state> ::= <BOL>

<BOL> → 0/OFF: Disable, 1/ON: Enable

Query parameter

None

Response format

<NBOL>

Setting example

MEAS:CURR:HARM:ENAB ON

Query example

MEAS:CURR:HARM:ENAB?

Response example

1

Remarks

The setting is ignored during the System Lock/warning.

The response message to the query is not returned during the System Lock.

4.2.2.51 Get Output Measured Value (for Specific Phase): Get Harmonic Current Value :MEASure[:SCALar]:CURRent:HARMonic[:RMS]?

Description

Gets the harmonic current [Arms]

Query parameter

< page > ::= <INT> | MINimum | MAXimum

<INT> → Page: 1 to 4

1 (order 1 to 10) | 2 (order 11 to 20) | 3 (order 21 to 30) | 4 (order 31 to 40)

MINimum → 1

MAXimum → 4

Response format

<NR2>,<NR2>,<NR2>,<NR2>,<NR2>,<NR2>,<NR2>,<NR2>,<NR2>,<NR2>

→ Query response range

For the query response range and resolution, see the instruction manual of the main unit.

Query example

MEAS:CURR:HARM? 1

Response example

2.24,0.02,0.01,0.15,0.06,0.08,0.01,0.01,0.02,0.06

Remarks

The response message to the query is not returned during the System Lock.

The query can be made only when the measurement query phase is L1, L2, or L3.

4.2.2.52 Get Output Measured Value (for Specific Phase): Get Harmonic Current Percentage :MEASure[:SCALar]:CURRent:HARMonic:RATio?

Description

Gets the harmonic current percentage [%]

Query parameter

< page > ::= <INT> | MINimum | MAXimum

<INT> → Page: 1 to 4

1 (order 1 to 10) | 2 (order 11 to 20) | 3 (order 21 to 30) | 4 (order 31 to 40)

MINimum → 1

MAXimum → 4

Response format

<NR2>,<NR2>,<NR2>,<NR2>,<NR2>,<NR2>,<NR2>,<NR2>,<NR2>,<NR2>

→ Query response range

For the query response range and resolution, see the instruction manual of the main unit.

Query example

MEAS:CURR:HARM:RAT? 1

Response example

100.0,0.1,0.1,0.1,0.1,0.1,0.1,0.1,0.1,0.1

Remarks

The response message to the query is not returned during the System Lock.

The query can be made only when the measurement query phase is L1, L2, or L3.

4.2.2.53 Get Output Measured Value (for Specific Phase): Get Output Current Crest Factor
:MEASure[:SCALar]:CURRent:CFACtor?

Description

Gets the output current crest factor

Query parameter

None

Response format

<NR2>→ Query response range

For the query response range and resolution, see the instruction manual of the main unit.

Query example

MEAS:CURR:CRES?

Response example

1.41

Remarks

The response message to the query is not returned during the System Lock.

The query can be made only when the measurement query phase is L1, L2, or L3.

4.2.2.54 Get Output Measured Value (for Specific Phase): Get Apparent Power
:MEASure[:SCALar]:POWer[:AC]:APParent?

Description

Gets the apparent power [VA]

Query parameter

None

Response format

<INT>→ (1000 [VA] or more)

<NR2>→ (Less than 1000 [VA])

Query response range

For the query response range and resolution, see the instruction manual of the main unit.

Query example

MEAS:POW:APP?

Response example

367.0

Remarks

The response message to the query is not returned during the System Lock.

The query can be made only when the measurement query phase is L1, L2, or L3.

4.2.2.55 Get Output Measured Value (for Specific Phase): Get Power Factor

:MEASure[:SCALar]:POWer[:AC]:PFACtor?

Description

Gets the power factor

Query parameter

None

Response format

<NR2>→ Query response range
0.00 to 1.00, Resolution 0.01

Query example

MEAS:POW:PFAC?

Response example

0.68

Remarks

The response message to the query is not returned during the System Lock.

The query can be made only when the measurement query phase is L1, L2, or L3.

4.2.2.56 Get Output Measured Value (for Specific Phase): Get Reactive Power

:MEASure[:SCALar]:POWer[:AC]:REACtive?

Description

Gets the reactive power [var]

Query parameter

None

Response format

<INT>→ (1000 [var] or more)
<NR2>→ (Less than 1000 [var])

For the query response range and resolution, see the instruction manual of the main unit.

Query example

MEAS:POW:REAC?

Response example

269.0

Remarks

The response message to the query is not returned during the System Lock.

The query can be made only when the measurement query phase is L1, L2, or L3.

4.2.2.57 Get Output Measured Value (for Specific Phase): Get Active Power

:MEASure[:SCALar]:POWer[:AC][:REAL]?

Description

Gets the active power [W]

Query parameter

None

Response format

<INT>→ (1000 [W] or more)

<NR2>→ (Less than 1000 [W])

For the query response range and resolution, see the instruction manual of the main unit.

Query example

MEAS:POW?

Response example

249.0

Remarks

The response message to the query is not returned during the System Lock.

The query can be made only when the measurement query phase is L1, L2, or L3.

4.2.2.58 CO₂ Calculation Function: Clear Emission CO₂ Integration Value

:MEASure: CO2:TOTal:CLEar

Description

Clears the emission CO₂ integration value

Setting parameter

None

Setting example

MEAS: CO2:TOT:CLE

Remarks

The command is ignored during the System Lock/warning.

4.2.2.59 CO₂ Calculation Function: Set/Get Emission CO₂ Coefficient

:MEASure: CO2:COEFFicient

DescriptionSets/gets the emission CO₂ coefficient [tCO₂/kWh]**Setting parameter**

<coef> | MINimum | MAXimum

<coef> ::= <REAL>

<REAL> → Emission CO₂ coefficient value [tCO₂/kWh]: 0.000001 to 0.010000

Resolution 0.000001

MINimum → 0.000001

MAXimum → 0.010000

Query parameter

[MINimum | MAXimum]

MINimum → Gets the minimum value

MAXimum → Gets the maximum value

Response format

<NR2>

Setting example

MEAS: CO2:COEF 0.0001

Query example

MEAS: CO2:COEF?

Response example

0.000100

Remarks

The setting is ignored during the System Lock/warning.

The response message to the query is not returned during the System Lock.

4.2.2.60 CO₂ Calculation Function: Get Emission CO₂ Internal Loss Instantaneous Value

:MEASure: CO2:RATE:LOSS?

Description

Gets the emission CO₂ internal loss instantaneous value [kgCO₂/h]

Query parameter

None

Response format

<NR2>

Query example

MEAS: CO2:RATE:LOSS?

Response example

0.7221

Remarks

The response message to the query is not returned during the System Lock.

4.2.2.61 CO₂ Calculation Function: Get Emission CO₂ Output Power Instantaneous Value

:MEASure: CO2:RATE:OUTPut?

Description

Gets the emission CO₂ output power instantaneous value [kgCO₂/h]

Query parameter

None

Response format

<NR2>

Query example

MEAS: CO2:RATE:OUTP?

Response example

32.9112

Remarks

The response message to the query is not returned during the System Lock.

4.2.2.62 CO₂ Calculation Function: Get Emission CO₂ Internal Loss Integration Value

:MEASure: CO2:TOTal:LOSS?

Description

Gets the emission CO₂ internal loss integration value [tCO₂]

Query parameter

None

Response format

<NR2>

Query example

MEAS: CO2:TOT:LOSS?

Response example

0.068136

Remarks

The response message to the query is not returned during the System Lock.

4.2.2.63 CO₂ Calculation Function: Get Emission CO₂ Output Power Integration Value

:MEASure: CO2:TOTal:OUTPut?

Description

Gets the emission CO₂ output power integration value [tCO₂]

Query parameter

None

Response format

<NR2>

Query example

MEAS: CO2:TOT:OUTP?

Response example

1.163182

Remarks

The response message to the query is not returned during the System Lock.

4.2.2.64 Set Output Correction Function: Enable/Disable AGC Function

:OUTPut:AGC

Description

Sets/gets the AGC

Setting parameter

<state> ::= <BOL>

<BOL> → 0/OFF: Disable, 1/ON: Enable

Query parameter

None

Response format

<NBOL>

Setting example

OUTP:AGC ON

Query example

OUTP:AGC?

Response example

1

Remarks

The setting is ignored during the System Lock/warning.

The response message to the query is not returned during the System Lock.

The AGC function can be used only when the output function is the Continuous function and the output mode is AC-INT/AC-VCA/AC-SYNC/DC-INT/DC-VCA.

When an AC voltage waveform other than SIN is selected, the AGC function cannot be enabled.

When the AGC function is enabled, and the output function is set to the Sequence or Simulation, the AGC function is forcibly disabled.

When the output function is set to the Sequence or Simulation, the AGC function cannot be enabled.

4.2.2.65 Set Output Correction Function: Enable/Disable Autocal Function

:OUTPut:ACALibration

Description

Sets/gets the Autocal

Setting parameter

<state> ::= <BOL>

<BOL> → 0/OFF: Disable, 1/ON: Enable

Query parameter

None

Response format

<NBOL>

Setting example

OUTP:ACAL ON

Query example

OUTP:ACAL?

Response example

1

Remarks

The setting is ignored during the System Lock/warning.

The response message to the query is not returned during the System Lock.

The Autocal function can be used only when the output function is the Continuous function and the output mode is AC-INT/AC-VCA/AC-SYNC/DC-INT/DC-VCA.

When an AC voltage waveform other than SIN is selected, the Autocal function cannot be enabled.

When the Autocal function is enabled, and the output function is set to the Sequence or Simulation, the Autocal function is forcibly disabled.

When the output function is set to the Sequence or Simulation, the Autocal function cannot be enabled.

4.2.2.66 Set External Input Signal: External Input Gain

:INPut:GAIN

Description

Sets/queries the external input gain

The setting can be made in the following modes:

AC-EXT, AC+DC-EXT, AC-VCA, DC-VCA, AC-ADD, AC+DC-ADD

Setting parameter

<inp gain> | MINimum | MAXimum

<inp gain> ::= <REAL>

<REAL> → External input gain: 0.0 to 220.0 (100V range), Resolution 0.1
0.0 to 440.0 (200V range), Resolution 0.1

MINimum → 0.0

MAXimum → 220.0 (100V range) | 440.0 (200V range)

Query parameter

[MINimum | MAXimum]

MINimum → Gets the minimum value

MAXimum → Gets the maximum value

Response format

<NR2>

Setting example

INP:GAIN 10

Query example

INP:GAIN?

Response example

10.0

Remarks

For the polyphase system, the setting can be made only when the signal source is VCA.

The setting is ignored during the System Lock/warning.

The response message to the query is not returned during the System Lock.

The setting cannot be done in the Sequence and Simulation.

4.2.2.67 Set External Input Signal: External Synchronization Signal Source

:INPut:SYNC:SOURce

Description

Sets/gets the external synchronization signal source

The setting can be made in the AC-SYNC and AC+DC-SYNC modes

Setting parameter

<cloc> ::= <DISC>

<DISC> ::= LINE | EXT

LINE → Line synchronization

EXT → External synchronization

Query parameter

None

Response format

<DISC>

Setting example

INP:SYNC:SOUR EXT

Query example

INP:SYNC:SOUR?

Response example

EXT

Remarks

The setting is ignored during the System Lock/warning.

The response message to the query is not returned during the System Lock.

The setting cannot be done in the Sequence and Simulation.

The setting cannot be done during the output on.

4.2.2.68 Set/Get Output Waveform: Set/Get Clipped Sine Wave Type Specification

[:SOURce]:FUNCtion:CSINe:TYPE

Description

Sets/gets the clipped sine wave setting type

Setting parameter

<func shap>,<type>

<func shap> ::= <DISC>

<DISC> ::= CLP1 | CLP2 | CLP3

CLP1 → Clipped sine wave 1

CLP2 → Clipped sine wave 2

CLP3 → Clipped sine wave 3

<type> ::= <DISC>

<DISC> ::= CFACTor | CLIP

CFACTor → Crest factor

CLIP → Clip

Query parameter

<func shap>

<func shap> ::= <DISC>

<DISC> ::= CLP1 | CLP2 | CLP3

Response format

<DISC>

Setting example

FUNC:CSIN:TYPE CLP1, CFACTOR

Query example

FUNC:CSIN:CFAC? CLP1

Response example

CFAC

Remarks

The setting is ignored during the System Lock/warning.

The response message to the query is not returned during the System Lock.

The setting cannot be done in the Sequence control state or Simulation control state.

4.2.2.69 Set/Get Output Waveform: Set/Get Clipped Sine Wave Crest Factor

[:SOURce]:FUNCtion:CSINe:CFACtor

Description

Sets/gets the clipped sine wave crest factor

Setting parameter

<func shap>,{<cf> | MINimum | MAXimum}

<func shap> ::= <DISC>

<DISC> ::= CLP1 | CLP2 | CLP3

CLP1 → Clipped sine wave 1

CLP2 → Clipped sine wave 2

CLP3 → Clipped sine wave 3

<cf> ::= <REAL>

<REAL> → Crest factor: 1.10 to 1.41, Resolution 0.01

MINimum → 1.10

MAXimum → 1.41

Query parameter

<func shap>[, MINimum | MAXimum]

<func shap> ::= <DISC>

<DISC> ::= CLP1 | CLP2 | CLP3

MINimum → Gets the minimum value

MAXimum → Gets the maximum value

Response format

<NR2>

Setting example

FUNC:CSIN:CFAC CLP1,1.2

Query example

FUNC:CSIN:CFAC? CLP1

Response example

1.20

Remarks

The setting is ignored during the System Lock/warning.

The response message to the query is not returned during the System Lock.

The setting cannot be done in the Sequence control state or Simulation control state.

4.2.2.70 Set/Get Output Waveform: Set/Get Clipped Sine Wave Clip Ratio

[:SOURce]:FUNCtion:CSINe:CLIP

Description

Sets/gets the clipped sine wave clip ratio

Setting parameter

<func shap>,{<clip> | MINimum | MAXimum}

<func shap> ::= <DISC>

<DISC> ::= CLP1 | CLP2 | CLP3

CLP1 → Clipped sine wave 1

CLP2 → Clipped sine wave 2

CLP3 → Clipped sine wave 3

<clip> ::= <REAL>

<REAL> → Clip ratio: 40.0 to 100.0, Resolution 0.1

MINimum → 40.0

MAXimum → 100.0

Query parameter

<func shap>[, MINimum | MAXimum]

<func shap> ::= <DISC>

<DISC> ::= CLP1 | CLP2 | CLP3

MINimum → Gets the minimum value

MAXimum → Gets the maximum value

Response format

<NR2>

Setting example

FUNC:CSIN:CLIP CLP1, 80

Query example

FUNC:CSIN:CLIP? CLP1

Response example

80.0

Remarks

The setting is ignored during the System Lock/warning.

The response message to the query is not returned during the System Lock.

The setting cannot be done in the Sequence control state or Simulation control state.

4.2.2.71 Set/Get Output Waveform: Save Clipped Sine Wave`:TRACe|DATA:CSINe:STORE`**Description**

Saves the clipped sine wave

Setting parameter

None

Setting example`TRAC:CSIN:STOR`**Remarks**

The setting is ignored during the System Lock/warning.

4.2.2.72 Set/Get Output Waveform: Initialize Arbitrary Wave Memory`:TRACe|DATA:WAVE:CLEAr`**Description**

Initializes the arbitrary wave memory

Setting parameter`<memory> | MINimum | MAXimum``<memory> ::= <INT>``<INT> → Arbitrary wave memory number: 1 to 16``MINimum → 1``MAXimum → 16`**Setting example**`TRAC:WAV:CLE 1`**Remarks**

The setting is ignored during the System Lock/warning.

4.2.2.73 Set/Get Output Waveform: Transfer Arbitrary Wave Data

:TRACe|DATA:WAVe[:DATA]

Description

Sets the arbitrary wave

Setting parameter

<memory>,<data>

<memory> ::= <INT>

<INT> → Arbitrary wave memory number: 1 to 16

<data> ::= <BLK>

<BLK> → Arbitrary waveform data

#48192<DAB>...<DAB>

#: Represents that the block data is sent

4: Represents the number of the subsequent numbers

8192: Represents the number of the subsequent byte data

<DAB>...<DAB>: 16-bit, 4096 words waveform data

The waveform data format is the complement form of 2 in the big endian

Setting example

TRAC:WAV 1, #48192<DAB>...<DAB>

Remarks

Not available for GPIB and RS232.

The setting is ignored during the System Lock/warning.

4.2.2.74 Set/Get Output Waveform: Specify Arbitrary Wave Name

:TRACe|DATA:WAVe:NAME

Description

Sets/gets the arbitrary wave name

Setting parameter

<memory>,<name>

<memory> ::= <INT>

<INT> → Arbitrary wave memory number: 1 to 16

<name> ::= <STR>

<STR> → Arbitrary wave name (20 characters or less)

The arbitrary wave name should contain 20 one-byte characters (alphanumeric characters) or less.

However, the following 9 characters cannot be used:

\ / : * ? " < > |

Query parameter

<memory> | MINimum | MAXimum

<memory> ::= <INT>

<INT> → Arbitrary wave memory number: 1 to 16

MINimum → Gets the arbitrary wave name for the arbitrary wave memory number 1

MAXimum → Gets the arbitrary wave name for the arbitrary wave memory number 16

Response format

<STR>

Setting example

TRAC:WAV:NAME 1,"ARB1"

Query example

TRAC:WAV:NAME? 1

Response example

"ARB1"

Remarks

The setting is ignored during the System Lock/warning.

4.2.2.75 Set External Control Signal: Permit/Inhibit External Control Input
:SYSTem:CONFigure:EXTio[:STATe]

Description

Sets/gets the external control input

Note that the external control input is ignored in the Remote state.

Setting parameter

<state> ::= <BOL>

<BOL> → 0/OFF: Disable, 1/ON: Enable

Query parameter

None

Response format

<NBOL>

Setting example

SYST:CONF:EXT ON

Query example

SYST:CONF:EXT?

Response example

1

Remarks

The setting is ignored during the System Lock/warning.

The response message to the query is not returned during the System Lock.

4.2.2.76 Set External Control Signal: Set/Get External Control Output Polarity

:SYSTem:CONFigure:EXTio:POLarity

Description

Sets/gets the external control output polarity

Setting parameter

<polarity> ::= <DISC>

<DISC> ::= POSitive | NEGative

POSitive → Positive logic

NEGative → Negative logic

Query parameter

None

Response format

<DISC>

Setting example

SYST:CONF:EXT:POL POSITIVE

Query example

SYST:CONF:EXT:POL?

Response example

POS

Remarks

The setting is ignored during the System Lock/warning.

The response message to the query is not returned during the System Lock.

4.2.3 Sequence Function Commands

4.2.3.1 Set Panel Display: Set Step Time Display Unit

:DISPlay[:WINDow]:TIME:UNIT

Description

Sets/gets the Sequence/Simulation Step Time unit

It is reflected to the display and setting on the panel

The setting/getting from the remote command is made in seconds regardless of the DISP:TIME:UNIT setting

Setting parameter

<unit> ::= <DISC>

<DISC> ::= MS | S

MS → millisecond

S → second

Query parameter

None

Response format

<DISC>

Setting example

DISP:TIME:UNIT MS

Query example

DISP:TIME:UNIT?

Response example

MS

Remarks

The setting is ignored during the System Lock/warning.

The response message to the query is not returned during the System Lock.

4.2.3.2 Sequence Function Control: Get State

[:SOURce]:SEQuence:CONTRol[:STATe]?

Description

Gets the sequence control state

Query parameter

None

Response format

<DISC>

Query example

SEQ:CONT?

Response example

EDIT Edit state

CONTROL Control state

Remarks

The response message to the query is not returned during the System Lock.

4.2.3.3 Sequence Function Control: Execution Control

:TRIGger:SEQuence:SELEcted:EXECute

Description

Sets the sequence control

Setting parameter

<ctrl> ::= <DISC>

<DISC> ::= STOP | STARt | HOLD | BRAN1 | BRAN2

STOP → Stop running

STARt → Start/resume running

HOLD → Suspend

BRAN1 → Branch 1

BRAN2 → Branch 2

Setting example

TRIG:SEQ:SEL:EXEC HOLD

Remarks

The setting is ignored during the System Lock/warning.

The operation can be made only in the Sequence control state.

4.2.3.4 Sequence Function Control: Switch to Edit Mode

[[:SOURce]:SEQuence:EDIT

Description

Sets the Sequence state to the Edit state

Switches it from the Control state to the Edit state

Setting parameter

None

Setting example

SEQ:EDIT

Remarks

The setting is ignored during the System Lock/warning.

The response message to the query is not returned during the System Lock.

The setting can be made only in the Sequence control state.

4.2.3.5 Sequence Function Control: Compile Setting Parameter and Switch to Control Mode

:TRIGger:SEQuence:COMPile

Description

Compiles the sequence data

Setting parameter

None

Setting example

TRIG:SEQ:COMP

Remarks

The command is ignored during the System Lock/warning.

The operation can be made only in the Sequence edit state.

4.2.3.6 Sequence Function Control: Get Running Step Number

[:SOURce]:SEQUence:CSTep?

Description

Gets the running step number

Query parameter

None

Response format

<INT>

Query example

SEQ:CST?

Response example

2

Remarks

The setting is ignored during the System Lock.

The response message to the query is not returned during the System Lock.

4.2.3.7 Set Parameter Common to Steps (Enabled at Edit Mode): Set Parameter Common to Steps [:SOURce]:SEQuence:CPARAmeter

Description

Sets/gets the sequence step-control parameter

Dummy data should be set for parameters excluded depending on the step.

Dummy data are not set.

Setting parameter

<time>,<start phs>,<start phs enable>,<stop phs >,<stop phs enable>,<step term>,

<jump to>,<jump enable>,<jump cnt>,<code>,

<branch1>,<branch1 enable>,<branch2>,<branch2 enable>,<trig out>

<time> ::= <REAL>

<REAL> → Step Time: 0.0010 to 999.9999, Resolution 0.0001

<start phs> ::= <REAL>

<REAL> → Start Phase: 0.0 to 359.9, Resolution 0.1

<start phs enable> ::= <BOL>

<BOL> → 0/OFF: Disable, 1/ON: Enable

<stop phs> ::= <REAL>

<REAL> → Stop Phase: 0.0 to 359.9, Resolution 0.1

<stop phs enable> ::= <BOL>

<BOL> → 0/OFF: Disable, 1/ON: Enable

<step term> ::= <DISC>

<DISC> ::= CONTInue | END | HOLD

CONTInue → Continue

END → Exit

HOLD → Hold

<jump to> ::= <INT>

<INT> → Jump-to step number: 0 to 255

<jump enable> ::= <BOL>

<BOL> → 0/OFF: Disable, 1/ON: Enable

<jump cnt> ::= <INT>

<INT> → Jump count: 0 to 9999

Jump count 0 means infinite

<code> ::= <INT>

<INT> → Step sync output: 0 to 3

<branch1> ::= <INT>

<INT> → Branch 1 destination: 0 to 255

<branch1 enable> ::= <BOL>

<BOL> → 0/OFF: Disable, 1/ON: Enable

<branch2> ::= <INT>

<INT> → Branch 2 destination: 0 to 255

<branch2 enable> ::= <BOL>

<BOL> → 0/OFF: Disable, 1/ON: Enable

<trig out> ::= < B O L >

<BOL> → 0/OFF: Disable, 1/ON: Enable

Query parameter

None

Response format

<NR2>,<NR2>,<NBOL>,<NR2>,<NBOL>,<DISC>,<INT>,<NBOL>,<INT>,<INT>,
<INT>,<NBOL>,<INT>,<NBOL>,<NBOL>

Setting example

SEQ:CPAR 10,90,ON,270,ON,CONT,3,ON,5,2,5,ON,6,ON,ON

Query example

SEQ:CPAR?

Response example

10.0000,90.0,1,270.0,1,CONT,3,1,5, 2,5,1,6,1,1

Remarks

The setting is ignored during the System Lock/warning.

The response message to the query is not returned during the System Lock.

The setting can be made only in the Sequence edit state.

4.2.3.8 Set Parameter for Specified Step (Enabled at Edit Mode): Specify Step Number to Set
[:SOURce]:SEQuence:STEP**Description**

Sets/gets the Sequence edit target step number

Setting parameter

<seq step> | MINimum | MAXimum

<seq step> ::= <INT>

<INT> → Sequence edit target step number: 0 to 255

MINimum → 0

MAXimum → 255

Query parameter

[MINimum | MAXimum]

MINimum → Gets the minimum value

MAXimum → Gets the maximum value

Response format

<INT>

Setting example

SEQ:STEP 1

Query example

SEQ:STEP?

Response example

1

Remarks

The setting is ignored during the System Lock/warning.

The response message to the query is not returned during the System Lock.

The setting can be made only in the Sequence edit state.

4.2.3.9 Set Specified Step Parameter (Enabled at Edit Mode): Specify Phase To Set (Phase Number)

[:SOURce]:SEQuence:INSTrument:NSElect

Description

Sets/gets the phase to set sequence (phase number)

Setting parameter

<phase number> | MINimum | MAXimum

<phase number> ::= <INT>

<INT> → Phase number: 0 to 2

0: L1 phase | 1: L2 phase | 2: L3 phase

MINimum → 0

MAXimum → 2

Query parameter

[MINimum | MAXimum]

MINimum → Gets the minimum value

MAXimum → Gets the maximum value

Response format

<INT>

Setting example

SEQ:INST:NSEL 1

Query example

SEQ:INST:NSEL?

Response example

1

Remarks

The setting is ignored during the System Lock/warning.

The response message to the query is not returned during the System Lock.

4.2.3.10 Set Specified Step Parameter (Enabled at Edit Mode): Specify Phase To Set (Phase)

[:SOURce]:SEQuence:INSTrument:SELect

Description

Sets/gets the phase to set sequence (phase)

Setting parameter

<phase name> ::= <DISC>

<DISC> ::= L1 | L2 | L3

L1 → L1 phase, L2 → L2 phase, L3 → L3 phase

Query parameter

None

Response format

<DISC>

Setting example

SEQ:INST:SEL L1

Query example

SEQ:INST:SEL?

Response example

L1

Remarks

The setting is ignored during the System Lock/warning.

The response message to the query is not returned during the System Lock.

4.2.3.11 Set Parameter for Specified Step (Enabled at Edit Mode): Set Step Parameter

[:SOURce]:SEQuence:SPARAmeter

Description

Sets/gets the sequence intra-Step parameter

Note that the setting range shown is for the 1.5kVA 100V range.

Dummy data should be set for parameters excluded depending on the mode, step, and phase.

Dummy data are not set.

Setting parameter

<acv>,<acv mode>,<dcv>,<dcv mode>,<freq>,<freq mode>,<wave>,<phase>

<acv> ::= <REAL>

<REAL> → AC voltage: 0.0 to 155.0 [Vrms], Resolution 0.1

The maximum voltage and the unit are different depending on the range and waveform

<acv mode> ::= <DISC>

<DISC> ::= CONST | KEEP | SWEEP

CONST → Constant

SWEEP → Sweep

KEEP → Keep

<dcv> ::= <REAL>

<REAL> → AC voltage:-220.0 to 220.0 [V], Resolution 0.1

The maximum voltage is different depending on the range

<dcv mode> ::= <DISC>

<DISC> ::= CONST | KEEP | SWEEP

CONST → Constant

SWEEP → Sweep

KEEP → Keep

<freq> ::= <REAL>

<REAL> → Frequency: 1.00 to 550.00, Resolution 0.01

The lower limit value is different depending on the AC/DC mode

<freq mode> ::= <DISC>

<DISC> ::= CONST | KEEP | SWEEP

CONST → Constant

SWEEP → Sweep

KEEP → Keep

<wave> ::= <DISC>

<DISC> ::= SIN | ARB1 | ARB2 | ARB3 | ARB4 | ARB5 | ARB6 | ARB7 |

ARB8 | ARB9 | ARB10 | ARB11 | ARB12 | ARB13 | ARB14 |

ARB15 | ARB16 | CLP1 | CLP2 | CLP3

SIN → Sine wave

ARB1 → Arbitrary wave 1

:

ARB16 → Arbitrary wave 16
CLP1 → Clipped sine wave 1
CLP2 → Clipped sine wave 2
CLP3 → Clipped sine wave 3

<phase> ::= <REAL>

<REAL> → Phase angle: 0.0~359.9, Resolution 0.1

For the single-phase three-wire

L12 default value: 180.0deg

For the three-phase

L12 default value: 120.0 deg, L13 default value: 240.0deg

Query parameter

None

Response format

<NR2>,<DISC>,<NR2>,<DISC>,<NR2>,<DISC>,<DISC>,<NR2>

Setting example

SEQ:SPAR 10,SWEEP,20,SWEEP,50,SWEEP,SIN,120

Query example

SEQ:SPAR?

Response example

10.0,SWEEP,20.0,SWEEP,50.00,SWEEP,SIN,120.0

Remarks

The setting is ignored during the System Lock/warning.

The response message to the query is not returned during the System Lock.

The setting can be made only in the Sequence edit state.

4.2.3.12 Initialize/Read/Save Sequence Data (Enabled at Edit Mode): Initialize Sequence Data

:TRACe|DATA:SEQuence:CLEAr

Description

Initializes the sequence data

Setting parameter

<seq memory> | MINimum | MAXimum

<seq memory> ::= <INT>

<INT> → 0 to 5

0 : Sequence data being edited

1 to 5 : Sequence Memory numbers 1-5

MINimum → 0

MAXimum → 5

Setting example

TRAC:SEQ:CLE 1

Remarks

The command is ignored during the System Lock/warning.

The operation cannot be done unless the output function is the Sequence.

4.2.3.13 Initialize/Read/Save Sequence Data (Enabled at Edit Mode): Sequence Data Name

:TRACe|DATA:SEQuence:NAME

Description

Sets/gets the sequence data name

Setting parameter

{<seq memory> | MINimum | MAXimum},<name>

<seq memory> ::= <INT>

<INT> → 1 to 5: Sequence Memory numbers 1-5

MINimum → 1

MAXimum → 5

<name> ::= <STR>

<STR> → Sequence data name

The sequence data name should contain 20 one-byte characters
(alphanumeric characters) or less.

However, the following 9 characters cannot be used:

\ / : * ? " < > |

Query parameter

<seq memory> | MINimum | MAXimum

<seq memory> ::= <INT>

<INT> → 1 to 5: Sequence Memory numbers 1-5

MINimum → 1

MAXimum → 5

Setting example

TRAC:SEQ:NAME 1,"SEQ1"

Query example

TRAC:SEQ:NAME? 1

Response example

"SEQ1"

Remarks

The setting is ignored during the System Lock/warning.

The response message to the query is not returned during the System Lock.

The setting/query cannot be done unless the output function is the Sequence.

4.2.3.14 Initialize/Read/Save Sequence Data (Enabled at Edit Mode): Read Sequence Data`:TRACe|DATA:SEQuence:RECall`**Description**

Reads the sequence data

Setting parameter`<seq memory> | MINimum | MAXimum``<seq memory> ::= <INT>``<INT> → Sequence Memory number: 1 to 5``MINimum → 1``MAXimum → 5`**Setting example**`TRAC:SEQ:REC 1`**Remarks**

The command is ignored during the System Lock/warning.

The operation cannot be done unless the output function is the Sequence.

4.2.3.15 Initialize/Read/Save Sequence Data (Enabled at Edit Mode): Save Sequence Data`:TRACe|DATA:SEQuence:STORe`**Description**

Saves the sequence data

Setting parameter`<seq memory> | MINimum | MAXimum``<seq memory> ::= <INT>``<INT> → Sequence Memory number: 1 to 5``MINimum → 1``MAXimum → 5`**Setting example**`TRAC:SEQ:STOR 1`**Remarks**

The command is ignored during the System Lock/warning.

The operation cannot be done unless the output function is the Sequence.

4.2.4 Simulation Function Commands

4.2.4.1 Set Panel Display: Set Step Time Display Unit

:DISPlay[:WINDow]:TIME:UNIT

Description

Sets/gets the Sequence/Simulation Step Time unit

It is reflected to the display and setting on the panel

The setting/getting from the remote command is made in seconds regardless of the DISP:TIME:UNIT setting

Setting parameter

<unit> ::= <DISC>

<DISC> ::= MS | S

MS → millisecond

S → second

Query parameter

None

Response format

<DISC>

Setting example

DISP:TIME:UNIT MS

Query example

DISP:TIME:UNIT?

Response example

MS

* Same as the Sequence function command.

4.2.4.2 Simulation Function Control: Get State

[:SOURce]:SIMulation:CONTrol[:STATe]?

Description

Gets the simulation control state

Query parameter

None

Response format

<DISC>

Query example

SIM:CONT?

Response example

EDIT Edit state

CONTROL Control state

Remarks

The response message to the query is not returned during the System Lock.

4.2.4.3 Simulation Function Control: Execution Control

:TRIGger:SIMulation:SElected:EXECute

Description

Sets the simulation control

Setting parameter

<ctrl> ::= <DISC>

<DISC> ::= STOP | START

STOP → Stop running

START → Start running

Setting example

TRIG:SIM:SEL:EXEC STAR

Remarks

The command is ignored during the System Lock/warning.

The operation can be made only in the Simulation control state.

4.2.4.4 Simulation Function Control: Switch to Edit Mode

[[:SOURce]:SIMulation:EDIT

Description

Sets the Simulation state to the Edit state

Switches it from the Control state to the Edit state

Setting parameter

None

Setting example

SIM:EDIT

Remarks

The setting is ignored during the System Lock/warning.

The setting can be made only in the Simulation control state.

4.2.4.5 Simulation Function Control: Compile Setting Parameter and Switch to Control Mode

:TRIGger:SIMulation:COMPIle

Description

Compiles the simulation data

Setting parameter

None

Setting example

TRIG:SIM:COMP

Remarks

The setting is ignored during the System Lock/warning.

The operation can be made only in the simulation edit state.

4.2.4.6 Simulation Function Control: Get Running Step Number

[[:SOURce]:]SIMulation:CSTep?

Description

Gets the running step number

Query parameter

None

Response format

<INT>

Query example

SIM:CST?

Response example

- 0 Initial Step
- 1 Normal 1 step
- 2 Transition 1 step
- 3 Abnormal step
- 4 Transition 2 step
- 5 Normal 2 step

Remarks

The response message to the query is not returned during the System Lock.

4.2.4.7 Set Repeat Execution (Enabled at Edit Mode): Enable/Disable Repeat Execution

[:SOURce]:SIMulation:REPeat:ENABLE

Description

Sets/gets whether to enable/disable the Simulation repeat count

Setting parameter

<state> ::= <BOL>

<BOL> → 0/OFF: Disable, 1/ON: Enable

Query parameter

None

Response format

<BOL>

Setting example

SIM:REP:ENAB ON

Query example

SIM:REP:ENAB?

Response example

1

Remarks

The setting is ignored during the System Lock/warning.

The response message to the query is not returned during the System Lock.

The setting/query can be made only in the simulation edit state.

4.2.4.8 Set Repeat Execution (Enabled at Edit Mode): Set Repeat Execution Count

[:SOURce]:SIMulation:REPeat:COUNT

Description

Sets/gets the Simulation repeat count

Setting parameter

<sim count> | MINimum | MAXimum

<sim count> ::= <INT>

<INT> → Repeat count: 0 to 9999 (0 means the infinite repeat)

MINimum → 0

MAXimum → 9999

Query parameter

[MINimum | MAXimum]

MINimum → Gets the minimum value

MAXimum → Gets the maximum value

Response format

<INT>

Setting example

SIM:REP:COUN 10

Query example

SIM:REP:COUN?

Response example

10

Remarks

The setting is ignored during the System Lock/warning.

The response message to the query is not returned during the System Lock.

The setting/query can be made only in the simulation edit state.

4.2.4.9 Set Parameter for Initial Step (Enabled at Edit Mode): Set Output Voltage

[:SOURce]:SIMulation:INITial:VOLTage

Description

Sets/gets the Initial Step amplitude

Setting parameter

<volt> | MINimum | MAXimum

<volt> ::= <REAL>

<REAL> → AC output voltage: 0.0 to 155.0 (100V range), Resolution 0.1

0.0 to 310.0 (200V range), Resolution 0.1

MINimum → 0.0

MAXimum → 155.0 (100V range) | 310.0 (200V range)

Query parameter

[MINimum | MAXimum]

MINimum → Gets the minimum value

MAXimum → Gets the maximum value

Response format

<NR2>

Setting example

SIM:INIT:VOLT 100

Query example

SIM:INIT:VOLT?

Response example

100.0

Remarks

The setting is ignored during the System Lock/warning.

The response message to the query is not returned during the System Lock.

The setting/query can be made only in the simulation edit state.

4.2.4.10 Set Parameter for Initial Step (Enabled at Edit Mode): Set Frequency

[:SOURce]:SIMulation:INITial:FREQuency

Description

Sets/gets the Initial Step frequency

Setting parameter

<frequency> | MINimum | MAXimum

<frequency> ::= <REAL>

<REAL> → Frequency: 1.00 to 550.00, Resolution 0.01

MINimum → 1.00

MAXimum → 550.00

Query parameter

[MINimum | MAXimum]

MINimum → Gets the minimum value

MAXimum → Gets the maximum value

Response format

<NR2>

Setting example

SIM:INIT:FREQ 50

Query example

SIM:INIT:FREQ?

Response example

50.0

Remarks

The setting is ignored during the System Lock/warning.

The response message to the query is not returned during the System Lock.

The setting/query can be made only in the simulation edit state.

4.2.4.11 Set Parameter for Initial Step (Enabled at Edit Mode): Set Whether to Enable/Disable Start Phase Specification
[:SOURce]:SIMulation:INITial:PHASe:STARt:ENABLE

Description

Sets/gets whether to enable/disable the Initial Step start phase

Setting parameter

<state> ::= <BOL>

<BOL> → 0/OFF: Disable, 1/ON: Enable

Query parameter

None

Response format

<NBOL>

Setting example

SIM:INIT:PHAS:STAR:ENAB ON

Query example

SIM:INIT:PHAS:STAR:ENAB?

Response example

1

Remarks

The setting is ignored during the System Lock/warning.

The response message to the query is not returned during the System Lock.

The setting/query can be made only in the simulation edit state.

4.2.4.12 Set Parameter for Initial Step (Enabled at Edit Mode): Set Start Phase

[:SOURce]:SIMulation:INITial:PHASe:STARt[:IMMEDIATE]

Description

Sets/gets the Initial Step start phase

Setting parameter

<phase> | MINimum | MAXimum

<phase> ::= <REAL>

<REAL> → Phase: 0.0 to 359.9, Resolution 0.1

MINimum → 0.0

MAXimum → 359.9

Query parameter

[MINimum | MAXimum]

MINimum → Gets the minimum value

MAXimum → Gets the maximum value

Response format

<NR2>

Setting example

SIM:INIT:PHAS:STAR 0

Query example

SIM:INIT:PHAS:STAR?

Response example

0.0

Remarks

The setting is ignored during the System Lock/warning.

The response message to the query is not returned during the System Lock.

The setting/query can be made only in the simulation edit state.

4.2.4.13 Set Parameter for Initial Step (Enabled at Edit Mode): Set Whether to Enable/Disable Stop Phase Specification
[:SOURce]:SIMulation:INITial:PHASe:STOP:ENABle

Description

Sets/gets whether to enable/disable the Initial Step stop phase

Setting parameter

<state> ::= <BOL>

<BOL> → 0/OFF: Disable, 1/ON: Enable

Query parameter

None

Response format

<NBOL>

Setting example

SIM:INIT:PHAS:STOP:ENAB ON

Query example

SIM:INIT:PHAS:STOP:ENAB?

Response example

1

Remarks

The setting is ignored during the System Lock/warning.

The response message to the query is not returned during the System Lock.

The setting/query can be made only in the simulation edit state.

4.2.4.14 Set Parameter for Initial Step (Enabled at Edit Mode): Set Stop Phase

[:SOURce]:SIMulation:INITial:PHASe:STOP[:IMMEDIATE]

Description

Sets/gets the Initial Step stop phase

Setting parameter

<phase> | MINimum | MAXimum

<phase> ::= <REAL>

<REAL> → Phase: 0.0 to 359.9, Resolution 0.1

MINimum → 0.0

MAXimum → 359.9

Query parameter

[MINimum | MAXimum]

MINimum → Gets the minimum value

MAXimum → Gets the maximum value

Response format

<NR2>

Setting example

SIM:INIT:PHAS:STOP 0

Query example

SIM:INIT:PHAS:STOP?

Response example

0.0

Remarks

The setting is ignored during the System Lock/warning.

The response message to the query is not returned during the System Lock.

The setting/query can be made only in the simulation edit state.

4.2.4.15 Set Parameter for Initial Step (Enabled at Edit Mode): Set Synchronization Output

[:SOURce]:SIMulation:INITial:CODE

Description

Sets/gets the Initial Step - step sync output

Setting parameter

<code> | MINimum | MAXimum

<code> ::= <INT>

<INT> → Step sync output: 0 to 3, Resolution 1

MINimum → 0

MAXimum → 3

Query parameter

[MINimum | MAXimum]

MINimum → Gets the minimum value

MAXimum → Gets the maximum value

Response format

<INT>

Setting example

SIM:INIT:CODE 1

Query example

SIM:INIT:CODE?

Response example

1

Remarks

The setting is ignored during the System Lock/warning.

The response message to the query is not returned during the System Lock.

The setting/query can be made only in the simulation edit state.

4.2.4.16 Set Parameter for Normal 1 Step Parameter (Enabled at Edit Mode): Set Execution Time

[:SOURce]:SIMulation:NORMal1:TIME

Description

Sets/gets the Normal 1 Step Step Time

The short form of NORMal1 is NORM1. "1" cannot be omitted.

Setting parameter

<sim step time> | MINimum | MAXimum

<sim step time> ::= <REAL>

<REAL> → Step Time: 0.0010 to 999.9999, Resolution 0.0001

MINimum → 0.0010

MAXimum → 999.9999

Query parameter

[MINimum | MAXimum]

MINimum → Gets the minimum value

MAXimum → Gets the maximum value

Response format

<NR2>

Setting example

SIM:NORM1:TIME 10

Query example

SIM:NORM1:TIME?

Response example

10.0000

Remarks

The setting is ignored during the System Lock/warning.

The response message to the query is not returned during the System Lock.

The setting/query can be made only in the simulation edit state.

4.2.4.17 Set Parameter for Normal 1 Step Parameter (Enabled at Edit Mode): Set Output Voltage

[:SOURce]:SIMulation:NORMal1:VOLTage

Description

Sets/gets the Normal 1 Step amplitude

The short form of NORMal1 is NORM1. "1" cannot be omitted.

Setting parameter

<volt> | MINimum | MAXimum

<volt> ::= <REAL>

<REAL> → AC output voltage: 0.0 to 155.0 (100V range), Resolution 0.1

0.0 to 310.0 (200V range), Resolution 0.1

MINimum → 0.0

MAXimum → 155.0 (100V range) | 310.0 (200V range)

Query parameter

[MINimum | MAXimum]

MINimum → Gets the minimum value

MAXimum → Gets the maximum value

Response format

<NR2>

Setting example

SIM:NORM1:VOLT 100

Query example

SIM:NORM1:VOLT?

Response example

100.0

Remarks

The setting is ignored during the System Lock/warning.

The response message to the query is not returned during the System Lock.

The setting/query can be made only in the simulation edit state.

4.2.4.18 Set Parameter for Normal 1 Step Parameter (Enabled at Edit Mode): Set Frequency

[:SOURce]:SIMulation:NORMal1:FREQuency

Description

Sets/gets the Normal 1 Step frequency

The short form of NORMal1 is NORM1. "1" cannot be omitted.

Setting parameter

<frequency> | MINimum | MAXimum

<frequency> ::= <REAL>

<REAL> → Frequency: 1.00 to 550.00, Resolution 0.01

MINimum → 1.00

MAXimum → 550.00

Query parameter

[MINimum | MAXimum]

MINimum → Gets the minimum value

MAXimum → Gets the maximum value

Response format

<NR2>

Setting example

SIM:NORM1:FREQ 50

Query example

SIM:NORM1:FREQ?

Response example

50.0

Remarks

The setting is ignored during the System Lock/warning.

The response message to the query is not returned during the System Lock.

The setting/query can be made only in the simulation edit state.

4.2.4.19 Set Parameter for Normal 1 Step (Enabled at Edit Mode): Set Whether to Enable/Disable Start Phase Specification
[:SOURce]:SIMulation:NORMal1:PHASe:STARt:ENABle

Description

Sets/gets whether to enable/disable the Normal 1 Step start phase
The short form of NORMal1 is NORM1. "1" cannot be omitted.

Setting parameter

<state> ::= <BOL>
<BOL> → 0/OFF: Disable, 1/ON: Enable

Query parameter

None

Response format

<NBOL>

Setting example

SIM:NORM1:PHAS:STAR:ENAB ON

Query example

SIM:NORM1:PHAS:STAR:ENAB?

Response example

1

Remarks

The setting is ignored during the System Lock/warning.
The response message to the query is not returned during the System Lock.
The setting/query can be made only in the simulation edit state.

4.2.4.20 Set Parameter for Normal 1 Step (Enabled at Edit Mode): Set Start Phase

[:SOURce]:SIMulation:NORMal1:PHASe:STARt[:IMMEDIATE]

Description

Sets/gets the Normal 1 Step start phase

The short form of NORMal1 is NORM1. "1" cannot be omitted.

Setting parameter

<phase> | MINimum | MAXimum

<phase> ::= <REAL>

<REAL> → Phase: 0.0 to 359.9, Resolution 0.1

MINimum → 0.0

MAXimum → 359.9

Query parameter

[MINimum | MAXimum]

MINimum → Gets the minimum value

MAXimum → Gets the maximum value

Response format

<NR2>

Setting example

SIM:NORM1:PHAS:STAR 0

Query example

SIM:NORM1:PHAS:STAR?

Response example

0.0

Remarks

The setting is ignored during the System Lock/warning.

The response message to the query is not returned during the System Lock.

The setting/query can be made only in the simulation edit state.

4.2.4.21 Set Parameter for Normal 1 Step (Enabled at Edit Mode): Set Whether to Enable/Disable Stop Phase Specification
[:SOURce]:SIMulation:NORMal1:PHASe:STOP:ENABle

Description

Sets/gets whether to enable/disable the Normal 1 Step stop phase
The short form of NORMal1 is NORM1. "1" cannot be omitted.

Setting parameter

<state> ::= <BOL>
<BOL> → 0/OFF: Disable, 1/ON: Enable

Query parameter

None

Response format

<NBOL>

Setting example

SIM:NORM1:PHAS:STOP:ENAB ON

Query example

SIM:NORM1:PHAS:STOP:ENAB?

Response example

1

Remarks

The setting is ignored during the System Lock/warning.
The response message to the query is not returned during the System Lock.
The setting/query can be made only in the simulation edit state.

4.2.4.22 Set Parameter for Normal 1 Step Parameter (Enabled at Edit Mode): Set Stop Phase

[:SOURce]:SIMulation:NORMal1:PHASe:STOP[:IMMEDIATE]

Description

Sets/gets the Normal 1 Step stop phase

The short form of NORMal1 is NORM1. "1" cannot be omitted.

Setting parameter

<phase> | MINimum | MAXimum

<phase> ::= <REAL>

<REAL> → Phase: 0.0 to 359.9, Resolution 0.1

MINimum → 0.0

MAXimum → 359.9

Query parameter

[MINimum | MAXimum]

MINimum → Gets the minimum value

MAXimum → Gets the maximum value

Response format

<NR2>

Setting example

SIM:NORM1:PHAS:STOP 0

Query example

SIM:NORM1:PHAS:STOP?

Response example

0.0

Remarks

The setting is ignored during the System Lock/warning.

The response message to the query is not returned during the System Lock.

The setting/query can be made only in the simulation edit state.

4.2.4.23 Set Parameter for Normal 1 Step Parameter (Enabled at Edit Mode): Set Synchronization

Output

[:SOURce]:SIMulation:NORMal1:CODE

Description

Sets/gets the Normal 1 Step step sync output

The short form of NORMal1 is NORM1. "1" cannot be omitted.

Setting parameter

<code> | MINimum | MAXimum

<code> ::= <INT>

<INT> → Step sync output: 0 to 3, Resolution 1

MINimum → 0

MAXimum → 3

Query parameter

[MINimum | MAXimum]

MINimum → Gets the minimum value

MAXimum → Gets the maximum value

Response format

<INT>

Setting example

SIM:NORM1:CODE 1

Query example

SIM:NORM1:CODE?

Response example

1

Remarks

The setting is ignored during the System Lock/warning.

The response message to the query is not returned during the System Lock.

The setting/query can be made only in the simulation edit state.

4.2.4.24 Set Parameter for Normal 1 Step (Enabled at Edit Mode): Set Trigger Output (G1)

[:SOURce]:SIMulation:NORMal1:TRIGger[:STATe]

Description

Sets/gets the Normal 1 Step trigger (G1)

The short form of NORMal1 is NORM1. "1" cannot be omitted.

Setting parameter

<state> ::= <BOL>

<BOL> → 0/OFF: Disable, 1/ON: Enable

Query parameter

None

Response format

<NBOL>

Setting example

SIM:NORM1:TRIG ON

Query example

SIM:NORM1:TRIG?

Response example

1

Remarks

The setting is ignored during the System Lock/warning.

The response message to the query is not returned during the System Lock.

The setting/query can be made only in the simulation edit state.

4.2.4.25 Set Parameter for Trans 1 Step Parameter (Enabled at Edit Mode): Set Execution Time

[:SOURCE]:SIMulation:TRANsition1:TIME

Description

Sets/gets the Trans 1 Step - Step Time

Setting parameter

<sim step time> | MINimum | MAXimum

<sim step time> ::= <REAL>

<REAL> → Step Time: 0.0000, 0.0010 to 999.9999, Resolution 0.0001

MINimum → 0.0000

MAXimum → 999.9999

Query parameter

[MINimum | MAXimum]

MINimum → Gets the minimum value

MAXimum → Gets the maximum value

Response format

<NR2>

Setting example

SIM:TRAN1:TIME 10

Query example

SIM:TRAN1:TIME?

Response example

10.0000

Remarks

The setting is ignored during the System Lock/warning.

The response message to the query is not returned during the System Lock.

The setting/query can be made only in the simulation edit state.

4.2.4.26 Set Parameter for Trans 1 Step Parameter (Enabled at Edit Mode): Set Synchronization

Output

[:SOURce]:SIMulation:TRANsition1:CODE

Description

Sets/gets the Trans 1 Step step sync output

Setting parameter

<code> | MINimum | MAXimum

<code> ::= <INT>

<INT> → Step sync output: 0 to 3, Resolution 1

MINimum → 0

MAXimum → 3

Query parameter

[MINimum | MAXimum]

MINimum → Gets the minimum value

MAXimum → Gets the maximum value

Response format

<INT>

Setting example

SIM:TRAN1:CODE 1

Query example

SIM:TRAN:CODE?

Response example

1

Remarks

The setting is ignored during the System Lock/warning.

The response message to the query is not returned during the System Lock.

The setting/query can be made only in the simulation edit state.

4.2.4.27 Set Parameter for Trans 1 Step (Enabled at Edit Mode): Set Trigger Output (G2)

[[:SOURce]:SIMulation:TRANsition1:TRIGger[:STATe]

Description

Sets/gets the Trans 1 Step trigger (G2)

Setting parameter

<state> ::= <BOL>

<BOL> → 0/OFF: Disable, 1/ON: Enable

Query parameter

None

Response format

<NBOL>

Setting example

SIM:TRAN1:TRIG ON

Query example

SIM:TRAN1:TRIG?

Response example

1

Remarks

The setting is ignored during the System Lock/warning.

The response message to the query is not returned during the System Lock.

The setting/query can be made only in the simulation edit state.

4.2.4.28 Set Parameter for Abnormal Step Parameter (Enabled at Edit Mode): Set Execution Time
[:SOURce]:SIMulation:ABNormal:TIME**Description**

Sets/gets the Abnormal Step - Step Time

Setting parameter

<sim step time> | MINimum | MAXimum

<sim step time> ::= <REAL>

<REAL> → Step Time: 0.0010 to 999.9999, Resolution 0.0001

MINimum → 0.0010

MAXimum → 999.9999

Query parameter

[MINimum | MAXimum]

MINimum → Gets the minimum value

MAXimum → Gets the maximum value

Response format

<NR2>

Setting example

SIM:ABN:TIME 10

Query example

SIM:ABN:TIME?

Response example

10.0000

Remarks

The setting is ignored during the System Lock/warning.

The response message to the query is not returned during the System Lock.

The setting/query can be made only in the simulation edit state.

4.2.4.29 Set Parameter for Abnormal Step Parameter (Enabled at Edit Mode): Set Output Voltage [:SOURce]:SIMulation:ABNormal:VOLTage

Description

Sets/gets the Abnormal Step abnormal amplitude

Setting parameter

<volt> | MINimum | MAXimum

<volt> ::= <REAL>

<REAL> → AC output voltage: 0.0 to 155.0 (100V range), Resolution 0.1
0.0 to 310.0 (200V range), Resolution 0.1

MINimum → 0.0

MAXimum → 155.0 (100V range) | 310.0 (200V range)

Query parameter

[MINimum | MAXimum]

MINimum → Gets the minimum value

MAXimum → Gets the maximum value

Response format

<NR2>

Setting example

SIM:ABN:VOLT 100

Query example

SIM:ABN:VOLT?

Response example

100.0

Remarks

The setting is ignored during the System Lock/warning.

The response message to the query is not returned during the System Lock.

The setting/query can be made only in the simulation edit state.

4.2.4.30 Set Parameter for Abnormal Step Parameter (Enabled at Edit Mode): Set Frequency

[:SOURce]:SIMulation:ABNormal:FREQuency

Description

Sets/gets the Abnormal Step abnormal frequency

Setting parameter

<frequency> | MINimum | MAXimum

<frequency> ::= <REAL>

<REAL> → Frequency: 1.00 to 550.00, Resolution 0.01

MINimum → 1.00

MAXimum → 550.00

Query parameter

[MINimum | MAXimum]

MINimum → Gets the minimum value

MAXimum → Gets the maximum value

Response format

<NR2>

Setting example

SIM:ABN:FREQ 50

Query example

SIM:ABN:FREQ?

Response example

50.0

Remarks

The setting is ignored during the System Lock/warning.

The response message to the query is not returned during the System Lock.

The setting/query can be made only in the simulation edit state.

4.2.4.31 Set Parameter for Abnormal Step (Enabled at Edit Mode): Set Whether to Enable/Disable Start Phase Specification
[:SOURce]:SIMulation:ABNormal:PHASe:STARt:ENABle

Description

Sets/gets whether to enable/disable the Abnormal Step start phase

Setting parameter

<state> ::= <BOL>

<BOL> → 0/OFF: Disable, 1/ON: Enable

Query parameter

None

Response format

<NBOL>

Setting example

SIM:ABN:PHAS:STAR:ENAB ON

Query example

SIM:ABN:PHAS:STAR:ENAB?

Response example

1

Remarks

The setting is ignored during the System Lock/warning.

The response message to the query is not returned during the System Lock.

The setting/query can be made only in the simulation edit state.

4.2.4.32 Set Parameter for Abnormal Step (Enabled at Edit Mode): Set Start Phase

[:SOURce]:SIMulation:ABNormal:PHASe:STARt[:IMMediate]

Description

Sets/gets the Abnormal Step start phase

Setting parameter

<phase> | MINimum | MAXimum

<phase> ::= <REAL>

<REAL> → Phase: 0.0 to 359.9, Resolution 0.1

MINimum → 0.0

MAXimum → 359.9

Query parameter

[MINimum | MAXimum]

MINimum → Gets the minimum value

MAXimum → Gets the maximum value

Response format

<NR2>

Setting example

SIM:ABN:PHAS:STAR 0

Query example

SIM:ABN:PHAS:STAR?

Response example

0.0

Remarks

The setting is ignored during the System Lock/warning.

The response message to the query is not returned during the System Lock.

The setting/query can be made only in the simulation edit state.

4.2.4.33 Set Parameter for Abnormal Step (Enabled at Edit Mode): Set Whether to Enable/Disable Stop Phase Specification
[:SOURce]:SIMulation:ABNormal:PHASe:STOP:ENABle

Description

Sets/gets whether to enable/disable the Abnormal Step stop phase

Setting parameter

<state> ::= <BOL>

<BOL> → 0/OFF: Disable, 1/ON: Enable

Query parameter

None

Response format

<NBOL>

Setting example

SIM:ABN:PHAS:STOP:ENAB ON

Query example

SIM:ABN:PHAS:STOP:ENAB?

Response example

1

Remarks

The setting is ignored during the System Lock/warning.

The response message to the query is not returned during the System Lock.

The setting/query can be made only in the simulation edit state.

4.2.4.34 Set Parameter for Abnormal Step Parameter (Enabled at Edit Mode): Set Stop Phase
[:SOURce]:SIMulation:ABNormal:PHASe:STOP[:IMMediate]**Description**

Sets/gets the Abnormal Step stop phase

Setting parameter

<phase> | MINimum | MAXimum

<phase> ::= <REAL>

<REAL> → Phase: 0.0 to 359.9, Resolution 0.1

MINimum → 0.0

MAXimum → 359.9

Query parameter

[MINimum | MAXimum]

MINimum → Gets the minimum value

MAXimum → Gets the maximum value

Response format

<NR2>

Setting example

SIM:ABN:PHAS:STOP 0

Query example

SIM:ABN:PHAS:STOP?

Response example

0.0

Remarks

The setting is ignored during the System Lock/warning.

The response message to the query is not returned during the System Lock.

The setting/query can be made only in the simulation edit state.

4.2.4.35 Set Parameter for Abnormal Step Parameter (Enabled at Edit Mode): Set Synchronization

Output

[:SOURce]:SIMulation:ABNormal:CODE

Description

Sets/gets the Abnormal Step - step sync output

Setting parameter

<code> | MINimum | MAXimum

<code> ::= <INT>

<INT> → Step sync output: 0 to 3, Resolution 1

MINimum → 0

MAXimum → 3

Query parameter

[MINimum | MAXimum]

MINimum → Gets the minimum value

MAXimum → Gets the maximum value

Response format

<INT>

Setting example

SIM:ABN:CODE 1

Query example

SIM:ABN:CODE?

Response example

1

Remarks

The setting is ignored during the System Lock/warning.

The response message to the query is not returned during the System Lock.

The setting/query can be made only in the simulation edit state.

4.2.4.36 Set Parameter for Abnormal Step (Enabled at Edit Mode): Set Trigger Output (G3)

[[:SOURce]:SIMulation:ABNormal:TRIGger[:STATe]

Description

Sets/gets the Abnormal Step trigger (G3)

Setting parameter

<state> ::= <BOL>

<BOL> → 0/OFF: Disable, 1/ON: Enable

Query parameter

None

Response format

<NBOL>

Setting example

SIM:ABN:TRIG ON

Query example

SIM:ABN:TRIG?

Response example

1

Remarks

The setting is ignored during the System Lock/warning.

The response message to the query is not returned during the System Lock.

The setting/query can be made only in the simulation edit state.

4.2.4.37 Set Parameter for Trans 2 Step Parameter (Enabled at Edit Mode): Set Execution Time

[:SOURce]:SIMulation:TRANsition2:TIME

Description

Sets/gets the Trans 2 Step - Step Time

Setting parameter

<sim step time> | MINimum | MAXimum

<sim step time> ::= <REAL>

<REAL> → Step Time: 0.0000, 0.0010 to 999.9999, Resolution 0.0001

MINimum → 0.0000

MAXimum → 999.9999

Query parameter

[MINimum | MAXimum]

MINimum → Gets the minimum value

MAXimum → Gets the maximum value

Response format

<NR2>

Setting example

SIM:TRAN2:TIME 10

Query example

SIM:TRAN2:TIME?

Response example

10.0000

Remarks

The setting is ignored during the System Lock/warning.

The response message to the query is not returned during the System Lock.

The setting/query can be made only in the simulation edit state.

4.2.4.38 Set Parameter for Trans 2 Step Parameter (Enabled at Edit Mode): Set Synchronization

Output

[:SOURce]:SIMulation:TRANsition2:CODE

Description

Sets/gets the Trans 2 Step - step sync output

Setting parameter

<code> | MINimum | MAXimum

<code> ::= <INT>

<INT> → Step sync output: 0 to 3, Resolution 1

MINimum → 0

MAXimum → 3

Query parameter

[MINimum | MAXimum]

MINimum → Gets the minimum value

MAXimum → Gets the maximum value

Response format

<INT>

Setting example

SIM:TRAN2:CODE 1

Query example

SIM:TRAN2:CODE?

Response example

1

Remarks

The setting is ignored during the System Lock/warning.

The response message to the query is not returned during the System Lock.

The setting/query can be made only in the simulation edit state.

4.2.4.39 Set Parameter for Trans 2 Step (Enabled at Edit Mode): Set Trigger Output (G4)

[:SOURce]:SIMulation:TRANsition2:TRIGger[:STATe]

Description

Sets/gets the Trans 2 Step trigger (G4)

Setting parameter

<state> ::= <BOL>

<BOL> → 0/OFF: Disable, 1/ON: Enable

Query parameter

None

Response format

<NBOL>

Setting example

SIM:TRAN2:TRIG ON

Query example

SIM:TRAN2:TRIG?

Response example

1

Remarks

The setting is ignored during the System Lock/warning.

The response message to the query is not returned during the System Lock.

The setting/query can be made only in the simulation edit state.

4.2.4.40 Set Parameter for Normal 2 Step Parameter (Enabled at Edit Mode): Set Execution Time

[:SOURce]:SIMulation:NORMal2:TIME

Description

Sets/gets the Normal 2 Step Step Time

The short form of NORMal2 is NORM2. "2" cannot be omitted.

Setting parameter

<sim step time> | MINimum | MAXimum

<sim step time> ::= <REAL>

<REAL> → Step Time: 0.0010 to 999.9999, Resolution 0.0001

MINimum → 0.0010

MAXimum → 999.9999

Query parameter

[MINimum | MAXimum]

MINimum → Gets the minimum value

MAXimum → Gets the maximum value

Response format

<NR2>

Setting example

SIM:NORM2:TIME 10

Query example

SIM:NORM2:TIME?

Response example

10.0000

Remarks

The setting is ignored during the System Lock/warning.

The response message to the query is not returned during the System Lock.

The setting/query can be made only in the simulation edit state.

4.2.4.41 Set Parameter for Normal 2 Step (Enabled at Edit Mode): Set Whether to Enable/Disable Start Phase Specification
[:SOURce]:SIMulation:NORMal2:PHASe:STARt:ENABle

Description

Sets/gets whether to enable/disable the Normal 2 Step start phase
The short form of NORMal2 is NORM2. "2" cannot be omitted.

Setting parameter

<state> ::= <BOL>
<BOL> → 0/OFF: Disable, 1/ON: Enable

Query parameter

None

Response format

<NBOL>

Setting example

SIM:NORM2:PHAS:STAR:ENAB ON

Query example

SIM:NORM2:PHAS:STAR:ENAB?

Response example

1

Remarks

The setting is ignored during the System Lock/warning.
The response message to the query is not returned during the System Lock.
The setting/query can be made only in the simulation edit state.

4.2.4.42 Set Parameter for Normal 2 Step (Enabled at Edit Mode): Set Start Phase

[:SOURce]:SIMulation:NORMal2:PHASe:STARt[:IMMEDIATE]

Description

Sets/gets the Normal 2 Step start phase

The short form of NORMal2 is NORM2. "2" cannot be omitted.

Setting parameter

<phase> | MINimum | MAXimum

<phase> ::= <REAL>

<REAL> → Phase: 0.0 to 359.9, Resolution 0.1

MINimum → 0.0

MAXimum → 359.9

Query parameter

[MINimum | MAXimum]

MINimum → Gets the minimum value

MAXimum → Gets the maximum value

Response format

<NR2>

Setting example

SIM:NORM2:PHAS:STAR 0

Query example

SIM:NORM2:PHAS:STAR?

Response example

0.0

Remarks

The setting is ignored during the System Lock/warning.

The response message to the query is not returned during the System Lock.

The setting/query can be made only in the simulation edit state.

4.2.4.43 Set Parameter for Normal 2 Step (Enabled at Edit Mode): Set Whether to Enable/Disable Stop Phase Specification
[:SOURce]:SIMulation:NORMal2:PHASe:STOP:ENABLE

Description

Sets/gets whether to enable/disable the Normal 2 Step stop phase
The short form of NORMal2 is NORM2. "2" cannot be omitted.

Setting parameter

<state> ::= <BOL>
<BOL> → 0/OFF: Disable, 1/ON: Enable

Query parameter

None

Response format

<NBOL>

Setting example

SIM:NORM2:PHAS:STOP:ENAB ON

Query example

SIM:NORM2:PHAS:STOP:ENAB?

Response example

1

Remarks

The setting is ignored during the System Lock/warning.
The response message to the query is not returned during the System Lock.
The setting/query can be made only in the simulation edit state.

4.2.4.44 Set Parameter for Normal 2 Step Parameter (Enabled at Edit Mode): Set Stop Phase

[:SOURce]:SIMulation:NORMal2:PHASe:STOP[:IMMEDIATE]

Description

Sets/gets the Normal 2 Step stop phase

The short form of NORMal2 is NORM2. "2" cannot be omitted.

Setting parameter

<phase> | MINimum | MAXimum

<phase> ::= <REAL>

<REAL> → Phase: 0.0 to 359.9, Resolution 0.1

MINimum → 0.0

MAXimum → 359.9

Query parameter

[MINimum | MAXimum]

MINimum → Gets the minimum value

MAXimum → Gets the maximum value

Response format

<NR2>

Setting example

SIM:NORM2:PHAS:STOP 0

Query example

SIM:NORM2:PHAS:STOP?

Response example

0.0

Remarks

The setting is ignored during the System Lock/warning.

The response message to the query is not returned during the System Lock.

The setting/query can be made only in the simulation edit state.

4.2.4.45 Set Parameter for Normal 2 Step Parameter (Enabled at Edit Mode): Set Synchronization

Output

[:SOURce]:SIMulation:NORMal2:CODE

Description

Sets/gets the Normal 2 Step step sync output

The short form of NORMal2 is NORM2. "2" cannot be omitted.

Setting parameter

<code> | MINimum | MAXimum

<code> ::= <INT>

<INT> → Step sync output: 0 to 3, Resolution 1

MINimum → 0

MAXimum → 3

Query parameter

[MINimum | MAXimum]

MINimum → Gets the minimum value

MAXimum → Gets the maximum value

Response format

<INT>

Setting example

SIM:NORM2:CODE 1

Query example

SIM:NORM2:CODE?

Response example

1

Remarks

The setting is ignored during the System Lock/warning.

The response message to the query is not returned during the System Lock.

The setting/query can be made only in the simulation edit state.

4.2.4.46 Set Parameter for Normal 2 Step (Enabled at Edit Mode): Set Trigger Output (G5)

[:SOURce]:SIMulation:NORMal2:TRIGger[:STATe]

Description

Sets/gets the Normal 2 Step trigger (G5)

The short form of NORMal2 is NORM2. "2" cannot be omitted.

Setting parameter

<state> ::= <BOL>

<BOL> → 0/OFF: Disable, 1/ON: Enable

Query parameter

None

Response format

<NBOL>

Setting example

SIM:NORM2:TRIG ON

Query example

SIM:NORM2:TRIG?

Response example

1

Remarks

The setting is ignored during the System Lock/warning.

The response message to the query is not returned during the System Lock.

The setting/query can be made only in the simulation edit state.

4.2.4.47 Initialize/Read/Save Simulation (Enabled at Edit Mode): Initialize Simulation Data

:TRACe|DATA:SIMulation:CLEar

Description

Initializes the simulation data

Setting parameter

<sim memory> | MINimum | MAXimum

<sim memory> ::= <INT>

<INT> → 0 to 5

0 : Simulation data being edited

1 to 5 : Simulation Memory number 1-5

MINimum → 0

MAXimum → 5

Setting example

TRAC:SIM:CLE 1

Remarks

The setting is ignored during the System Lock/warning.

The response message to the query is not returned during the System Lock.

The operation cannot be done unless the output function is the Simulation.

4.2.4.48 Initialize/Read/Save Simulation (Enabled at Edit Mode): Simulation Data Name

:TRACe|DATA:SIMulation:NAME

Description

Sets/gets the simulation data name

Setting parameter

{<sim memory> | MINimum | MAXimum},<name>

<sim memory> ::= <INT>

<INT> → 1 to 5: Simulation Memory number 1-5

MINimum → 1

MAXimum → 5

<name> ::= <STR>

<STR> → Simulation data name

The simulation data name should contain 20 one-byte characters (alphanumeric characters) or less.

However, the following 9 characters cannot be used:

\ / : * ? " < > |

Query parameter

<sim memory> | MINimum | MAXimum

<sim memory> ::= <INT>

<INT> → 1 to 5: Simulation Memory number 1-5

MINimum → 1

MAXimum → 5

Setting example

TRAC:SIM:NAME 1,"SIM1"

Query example

TRAC:SIM:NAME? 1

Response example

"SIM1"

Remarks

The setting is ignored during the System Lock/warning.

The response message to the query is not returned during the System Lock.

The setting cannot be done unless the output function is the Simulation.

4.2.4.49 Initialize/Read/Save Simulation (Enabled at Edit Mode): Read Simulation Data

:TRACe|DATA:SIMulation:RECall

Description

Reads the simulation data

Setting parameter

<sim memory> | MINimum | MAXimum

<sim memory> ::= <INT>

<INT> → Simulation Memory number: 1 to 5

MINimum → 1

MAXimum → 5

Setting example

TRAC:SIM:REC 1

Remarks

The command is ignored during the System Lock/warning.

The operation cannot be done unless the output function is the Simulation.

4.2.4.50 Initialize/Read/Save Simulation (Enabled at Edit Mode): Save Simulation Data

:TRACe|DATA:SIMulation:STORe

Description

Saves the simulation data

Setting parameter

<sim memory> | MINimum | MAXimum

<sim memory> ::= <INT>

<INT> → Simulation Memory number: 1 to 5

MINimum → 1

MAXimum → 5

Setting example

TRAC:SIM:STOR 1

Remarks

The command is ignored during the System Lock/warning.

The operation cannot be done unless the output function is the Simulation.

5. Programming Sample

5.1 KP3000S Control Programming	230
5.2 Continuous Function Setting.....	231
5.3 Sequence Function Control	234
5.4 Simulation Function Control	236
5.5 Obtain Status Register	238
5.6 Cautions in Programming	240

5.1 KP3000S Control Programming

This section explains how to remote-control the KP3000S from the personal computer through the USB interface.

This section assumes an understanding of the VISA (Virtual Instrument System Architecture) programming interface and programming language supported by the VISA library.

This program is checking the operation in the following environment.

VISA library : National Instruments' NI-VISA.net 16 Library.

* Added ".NET 4.0 Development Support (NS)" to the function to be installed.

Programming Environment: Microsoft Visual Studio 2015 .Net Framework 4.0 or higher with C# language

a) Continuous output setting

Switch the output function mode to Continuous, make the output setting, then turn on the output. After that, use the measurement function to read the measured output value.

b) Sequence function control

Switch the output function mode to Sequence, read the sequence data pre-stored in the main unit, and start the sequence execution. After that, use the measurement function to read the measured output value.

c) Simulation function control

Switch the output function mode to Simulation, read the simulation data pre-stored in the main unit, and start the power fluctuation simulation. After that, use the measurement function to read the measured output value.

d) Obtain status register

After setting the warning status transition filter and the warning event enable register, obtain the status byte to check for the warning state.

These explanations are intended for helping you understand the remote command control procedure, and thus omit general programming considerations such as error detection processing and variable initialization processing.

For the VISA library installation, see the document from the VISA library distributors.

5.2 Continuous Function Setting

```
using System.Windows.Forms;

// <Process flow>
// ■Initialize the communication state.
// Namespace declaration of NI-VISA library
using NationalInstruments.VisaNS;

// Search for KP3000S using the resource string
string[] strResNames;

// Generate the VISA session of the NI-VISA library
ResourceManager rm;
rm = ResourceManager.GetLocalManager();

// Use the VISA session to specify the KP3000S serial number and
// establish the communication session with the KP3000S
//
// In your program, write the exception handling.
// Use catch to write the error handling when communication session is established.
// Whenever an error occurs, NI-VISA library throws it to the exception.
//
strResNames = rm.FindResources("USB0::0x0D4A::0x0021::0000000::INSTR");
MessageBasedSession bs;
bs = new MessageBasedSession(strResNames[0]);

// Set to the Remote State
new UsbSession(bs.ResourceName).ControlRen(RenMode.Assert);

// Clear the device
bs.Clear();

// Clear the error status
bs.Write("*CLS");
System.Threading.Thread.Sleep(1000);

// ■Set the output function to Continuous.
bs.Write(":SYSTem:CONFigure:MODE CONTInuous");
System.Threading.Thread.Sleep(1000);
```

```
// ■Return the KP3000S to the initial state just after the startup.
// Return the output setting to the state just after the startup.
bs.Write("*RST");
System.Threading.Thread.Sleep(1000);

// ■Set the output mode.
bs.Write(":SOURce:MODE AC_INT");
System.Threading.Thread.Sleep(1000);

// ■Set the output range.
bs.Write(":SOURce:VOLtage:RANGe R100V");
System.Threading.Thread.Sleep(1000);

// ■Set the output waveform.
bs.Write(":SOURce:FUNcTION:SHAPE:IMMediate SIN");
System.Threading.Thread.Sleep(1000);

// ■Set the output frequency.
bs.Write(":SOURce:FREQuency:IMMediate 50.00");
System.Threading.Thread.Sleep(1000);

// ■Set the output voltage.
bs.Write(":SOURce:VOLtAge:LEVel:IMMediate:AMPLitude 100.0");
System.Threading.Thread.Sleep(1000);

// ■Turn on the output.
bs.Write(":OUTPut:STATe ON");
System.Threading.Thread.Sleep(1000);

// ■Obtain the measured output voltage value.
string strMeasureVoltageRMS = "";
strMeasureVoltageRMS = bs.Query(":MEASure:SCALAr:VOLtAge:RMS?");

// ■Obtain the measured output current value.
string strMeasureCurrentRMS = "";
strMeasureCurrentRMS = bs.Query(":MEASure:SCALAr:CURRent:RMS?");

// ■Turn off the output.
bs.Write(":OUTPut:STATe OFF");
```

```
// Clear the Remote state
new UsbSession(bs.ResourceName).ControlRen(RenMode.Deassert);

// ■ Terminate the communication and release the session.
bs.Terminate();
bs.Dispose();
```

5.3 Sequence Function Control

```
using System.Windows.Forms;

// <Process flow>
// ■Initialize the communication state.
// Namespace declaration of NI-VISA library
using NationalInstruments.VisaNS;

// Search for KP3000S using the resource string
string[] strResNames;

// Generate the VISA session of the NI-VISA library
ResourceManager rm;
rm = ResourceManager.GetLocalManager();

// Use the VISA session to specify the KP3000S serial number and
// establish the communication session with the KP3000S
//
// In your program, write the exception handling.
// Use catch to write the error handling when communication session is established.
// Whenever an error occurs, NI-VISA library throws it to the exception.
//
strResNames = rm.FindResources("USB0::0x0D4A::0x0021::0000000::INSTR");
MessageBasedSession bs;
bs = new MessageBasedSession(strResNames[0]);

// Set to the Remote State
new UsbSession(bs.ResourceName).ControlRen(RenMode.Assert);

// Clear the device
bs.Clear();

// Clear the error status
bs.Write("*CLS");
System.Threading.Thread.Sleep(1000);

// ■Set the output function to Sequence.
bs.Write(":SYSTem:CONFigure:MODE SEquence");
System.Threading.Thread.Sleep(1000);
```

```
// ■ Recall the sequence data from the Sequence Memory 1.
bs.Write(":TRACe:SEQuence:RECall 1");
System.Threading.Thread.Sleep(1000);

// ■ Compile the sequence data.
bs.Write(":TRIGger:SEQuence:COMPile");
System.Threading.Thread.Sleep(1000);

// ■ Turn on the output.
bs.Write(":OUTPut:STATe ON");
System.Threading.Thread.Sleep(1000);

// ■ Start the sequence.
bs.Write(":TRIGger:SEQuence:SELEcted:EXECute STARt");
System.Threading.Thread.Sleep(1000);

// ■ Obtain the measured output voltage value.
string strMeasureVoltageRMS = "";
strMeasureVoltageRMS = bs.Query(":MEASure:SCALAr:VOLTage:RMS?");

// ■ Obtain the measured output current value.
string strMeasureCurrentRMS = "";
strMeasureCurrentRMS = bs.Query(":MEASure:SCALAr:CURRent:RMS?");

// ■ Turn off the output.
bs.Write(":OUTPut:STATe OFF");
System.Threading.Thread.Sleep(1000);

// ■ Change to the Edit mode.
bs.Write(":SOURce:SEQuence:EDIT");

// Clear the Remote state
new UsbSession(bs.ResourceName).ControlRen(RenMode.Deassert);

// ■ Terminate the communication and release the session.
bs.Terminate();
bs.Dispose();
```

5.4 Simulation Function Control

```
using System.Windows.Forms;

// <Process flow>
// ■Initialize the communication state.
// Namespace declaration of NI-VISA library
using NationalInstruments.VisaNS;

// Search for KP3000S using the resource string
string[] strResNames;

// Generate the VISA session of the NI-VISA library
ResourceManager rm;
rm = ResourceManager.GetLocalManager();

// Use the VISA session to specify the KP3000S serial number and
// establish the communication session with the KP3000S
//
// In your program, write the exception handling.
// Use catch to write the error handling when communication session is established.
// Whenever an error occurs, NI-VISA library throws it to the exception.
//
strResNames = rm.FindResources("USB0::0x0D4A::0x0021::0000000::INSTR");
MessageBasedSession bs;
bs = new MessageBasedSession(strResNames[0]);

// Set to the Remote State
new UsbSession(bs.ResourceName).ControlRen(RenMode.Assert);

// Clear the device
bs.Clear();

// Clear the error status
bs.Write("*CLS");
System.Threading.Thread.Sleep(1000);

// ■Set the output function to Simulation.
bs.Write(":SYSTem:CONFigure:MODE SIMulation");
System.Threading.Thread.Sleep(1000);
```

```
// ■ Recall the power fluctuation simulation data from the Simulation Memory 1.
bs.Write(":TRACe:SIMulation:RECall 1");
System.Threading.Thread.Sleep(1000);

// ■ Compile the simulation data.
bs.Write(":TRIGger:SIMulation:COMPile");
System.Threading.Thread.Sleep(1000);

// ■ Turn on the output.
bs.Write(":OUTPut:STATe ON");
System.Threading.Thread.Sleep(1000);

// ■ Starts the Simulation.
bs.Write(":TRIGger:SIMulation:SElected:EXECute START");
System.Threading.Thread.Sleep(1000);

// ■ Obtain the measured output voltage value.
string strMeasureVoltageRMS = "";
strMeasureVoltageRMS = bs.Query(":MEASure:SCALar:VOLTage:RMS?");

// ■ Obtain the measured output current value.
string strMeasureCurrentRMS = "";
strMeasureCurrentRMS = bs.Query(":MEASure:SCALar:CURRent:RMS?");

// ■ Turn off the output.
bs.Write(":OUTPut:STATe OFF");
System.Threading.Thread.Sleep(1000);

// ■ Change to the Edit mode.
bs.Write(":SOURce:SIMulation:EDIT");

// Clear the Remote state
new UsbSession(bs.ResourceName).ControlRen(RenMode.Deassert);

// ■ Terminate the communication and release the session.
bs.Terminate();
bs.Dispose();
```

5.5 Obtain Status Register

```
using System.Windows.Forms;

// <Process flow>
// ■ Initialize the communication state.
// Namespace declaration of NI-VISA library
using NationalInstruments.VisaNS;

// Search for KP3000S using the resource string
string[] strResNames;

// Use the VISA session to specify the KP3000S serial number and
// establish the communication session with the KP3000S
//
// In your program, write the exception handling.
// Use catch to write the error handling when communication session is established.
// Whenever an error occurs, NI-VISA library throws it to the exception.
//
strResNames = rm.FindResources("USB0::0x0D4A::0x0021::00000000::INSTR");
MessageBasedSession bs;
bs = new MessageBasedSession(strResNames[0]);

// Set to the Remote State
new UsbSession(bs.ResourceName).ControlRen(RenMode.Assert);

// Clear the device
bs.Clear();

// Clear the error status
bs.Write("*CLS");
System.Threading.Thread.Sleep(1000);

// Set the warning transition filter (positive logic)
bs.Write(":STATus:WARNing:PTRansition 65535");
System.Threading.Thread.Sleep(1000);

// Set permission of the warning event register
bs.Write(":STATus:WARNing:ENABle 65535");
System.Threading.Thread.Sleep(1000);
```



```

// ■Obtain the status byte to check if the warning state is detected

// ReadStatusByte() needs to be repeatedly queried in order to detect the change
// in each bit of the register.
// In actual programming, the status byte is acquired by worker-threading or
// other means.

StatusByteFlags sbFlag = 0;
sbFlag = bs.ReadStatusByte();

short sFlag = (short)sbFlag;

// Status changes
if (sFlag != 0)
{
    // Is the warning register detected?
    if ((sFlag & 2) == 2)
    {
        // Obtain the warning state
        string strWarn = "";
        strWarn = bs.Query(":STATus:WARNing:CONDition?");

        System.Threading.Thread.Sleep(1000);

        // Release the warning
        // This also clears the warning screen display on the KP3000S.
        bs.Write(":SYSTem:WRELease");
        System.Threading.Thread.Sleep(1000);
    }
}

// Clear the Remote state
new UsbSession(bs.ResourceName).ControlRen(RenMode.Deassert);

// ■Terminate the communication and release the session.
bs.Terminate();
bs.Dispose();

```

5.6 Cautions in Programming

- a) When a program command send from the computer is interrupted on the way, an error may occur in the next program command. If there was an interruption on the way, perform the device clear.
- b) When the computer interrupts receiving on the way after the computer sent a query message then data transfer was started with the KP3000S specified as talker, the KP3000S may freeze awaiting for send. If there was an interruption on the way, perform the device clear.
- c) After the computer sent a query message, if the computer sends another query message without specifying the KP3000S as talker, the response to the first query may be returned with the trailing response to the next one (without delimiter).

When the KP3000S does not work as talker after a query message is sent, perform the device clear.

6. Error Message List

6.1 Error Message List	242
------------------------------	-----

6.1 Error Message List

Table 6.1 shows the list of error messages.

Table 6.1 Error Message List

ID	Message	Meaning
0	No error	There is no error.
-100	Command error	An illegal command was received.
-102	Syntax error	An undefined command or parameter was received.
-103	Invalid separator	An illegal separator was received.
-104	Data type error	The received command or parameter was undefined, and thus was recognized as an illegal command.
-108	Parameter not allowed	There are too many parameters.
-109	Missing parameter	One or more parameters are missing.
-110	Command header error	There is an error in the command header.
-111	Header separator error	There is an error in the keyword separator of the command header.
-113	Undefined header	The received string contains an invalid header.
-120	Numeric data error	There is an error in the numerical parameter.
-130	Suffix error	There is an error in the suffix of the numerical parameter.
-140	Character data error	There is an error in the discrete parameter.
-144	Character data too long	The discrete parameter is too long.
-150	String data error	There is an error in the string parameter.
-160	Block data error	There is an error in the block parameter.
-200	Execution error	An error was detected during command execution.
-222	Data out of range	A command parameter is out of the valid range.
-300	Device-specific error	This is a device-specific error.
-350	Queue overflow	The error queue overflowed and thus can no longer hold a new error.
-363	Input buffer overrun	The command input buffer overflowed.
-410	Query INTERRUPTED	A new response message entered the output queue, and thus the previous message was lost.
-420	Query UNTERMINATED	The talker was specified, but the output queue has no response message.
-430	Query DEADLOCKED	Send/receive came to a deadlock. Sending is canceled.
-440	Query UNTERMINATED after indefinite response	The response request order is wrong.
2	Invalid in This Output Mode	This output mode does not allow the setting (execution). Change the output mode.
3	Invalid with Output ON	The output on state does not allow the setting (execution). Turn the output off, then set (execute).
4	Invalid with Output OFF	The output off state does not allow the setting (execution). Turn the output on, then set (execute).
5	Busy	The busy state does not allow the setting (execution). Execute after the busy icon disappears.
6	Invalid with Remote Control	The remote control state does not allow the setting (execution). Bring the state to local control, then set (execute).
13	Auto Cal Disabled	The Autocal setting becomes off because of out of the calibration range.

6.1 Error Message List

15	AGC Disabled	The AGC setting becomes off because of out of the calibration range.
20	Invalid	The condition cannot be set (executed).
24	USB Memory Unconnected	No USB memory is connected. Connect a USB memory.
25	USB Memory Removed illegally	The USB memory was removed before the eject operation. Perform the eject operation before removing a USB memory.
26	USB Memory Access Error	The USB memory has an access error.
27	Too Many Files	There are too many files in the USB memory. Each folder can contain 500 files or less.
29	Sync Frequency Unlocked	The output cannot be turned on because of not locking to the synchronization frequency.
30	Remote Controller Error	Communication with the remote controller cannot be made. Make sure the remote controller cable is connected properly.
31	Internal Memory Error	The internal memory has an error.
32	Calibration Data Error ME	The adjustment data is abnormal. Cycle the power. If it still occurs, contact the seller (NF Corporation or our agent) from whom you purchased the product.
33	Line Overvoltage	The power input voltage is excessive. Check if the power input is appropriate.
34	Line Undervoltage	The power input voltage is insufficient. Check if the power input is appropriate.
35	Line Frequency Error	The power input frequency is abnormal. Check if the power input is appropriate.
36	Communication Failure PU	There is a communication error between the firmware and the power unit. Cycle the power. If it still occurs, contact the seller (NF Corporation or our agent) from whom you purchased the product.
37	Communication Failure ME	There is a communication error between the firmware and the output measurement section. Cycle the power. If it still occurs, contact the seller (NF Corporation or our agent) from whom you purchased the product.
38	Communication Failure SC	The polyphase system communication is abnormal. Make sure the System Cable is connected properly.
40	Polyphase Connection Timeout	In the polyphase system, the connection destination cannot be recognized in the specified time. Make sure the System Cable is connected properly, then turn on the power of all the cabinets in 20 seconds.
41	Mismatched Firmware Versions	In the polyphase system, the main firmware versions of the cabinets do not match.
45	Mismatched Cabinet Connect	In the polyphase system, the output capacities of the phases do not match.
47	No Available Power Unit	There is no power unit that can be started.
68	PU-ON Setting Updated	The power unit power-on setting was updated.
69	Polyphase Connection Updated	A phase configuration is detected that is different from the previous one.
82	Sequence Compile Error	Sequence compilation failed.
83	Simulation Compile Error	Simulation compilation failed.

6.1 Error Message List

84	System Updated Please Reboot	The firmware was updated.
85	System Updated Please Reboot	The firmware was updated.
87	Unbalanced Line Voltage	In the polyphase system, there is a cabinet with a different power supply voltage. Use the same power supply voltage.
88	12V Error	The internal auxiliary power is abnormal.

7. Specifications

7.1 Interface Functions.....	246
7.2 GPIB Bus Driver	246
7.3 Code Used	247
7.4 Response to Interface Message	247
7.5 Multi-Line Interface Message.....	248
7.6 List of functions supported by LXI.....	249

7.1 Interface Functions

Table 7.1 Interface Functions

Function		Subset	Description
Source handshake		SH1	All send handshake functions provided
Acceptor handshake		AH1	All receive handshake functions provided
Talker		T6	Basic talker functions, Talker release by the MLA
Listener		L4	Basic listener functions, Listener release by the MTA
Service request	USBTMC	SR1	All service request functions provided
	GPIB	SR0	Service request function not provided
Remote/Local		RL1	All remote/local functions provided
Parallel poll		PP0	Parallel poll function not provided
Device clear		DC1	All device clear functions provided
Device trigger		DT0	Device trigger function not provided
Controller		C0	Controller function not provided

- RS232 and LAN interface do not correspond to all the above functions.

7.2 GPIB Bus Driver

Table 7.2 Bus Driver Specifications

Data bus	DIO1 to 8	Open collector
Handshake bus	NRFD, NDAC, DAV	Open collector tri-state
Management bus	SRQ EOI	Open collector tri-state

7.3 Code Used

The KP3000S as the listener can accept ISO 7-bit codes (JIS/ASCII), except when receiving binary data, and ignores MSB of 8-bit data (e.g., parity). Any program codes are interpreted and executed with no case sensitivity. However, the control characters except <CR>, <LF>, and <TAB> (codes from 0 to 8, B, D to 1F, and 7F in hexadecimal) are ignored.

As the talker, it sends ISO 7-bit codes (JIS or ASCII) with no parity except when sending binary data (MSB of 8-bit data = 0). All alphabetical characters in the program code are sent in uppercase.

When binary data is sent and received, all 8-bit patterns are valid and the standard IEEE floating point format (including any control codes) is supported.

7.4 Response to Interface Message

Table 7.3 Response to Interface Message

IFC	<ul style="list-style-type: none"> • Initialize the GPIB interface message. • Release the specified listener or talker.
DCL and SDC	<ul style="list-style-type: none"> • Clear the I/O buffer for GPIB.
LLO	<ul style="list-style-type: none"> • Disable the LOCAL key on the panel.
GTL	<ul style="list-style-type: none"> • Turn to the Local state.

7.5 Multi-Line Interface Message

*2					b7	0	*1	0	0	0	0	1	1	1	1	1	1												
					b6	0	MSG	0	MSG	1	MSG	0	MSG	0	MSG	1	MSG												
					b5	0		1		0		1		0		1													
b4	b3	b2	b1	Row	Column	0	1	2	3	4	5	6	7																
0	0	0	0	0	NUL		DLE		SP	↑	0	↑	@	↑	P	↑	`	↑	p	↑									
0	0	0	1	1	SOH	GTL	DC1	LLO	!	↑	1	↑	A	↑	Q	↑	a	↑	q	↑									
0	0	1	0	2	STX		DC2		"	↑	2	↑	B	↑	R	↑	b	↑	r	↑									
0	0	1	1	3	ETX		DC3		#	↑	3	↑	C	↑	S	↑	c	↑	s	↑									
0	1	0	0	4	EOT	SDC	DC4	DCL	\$	↑	4	↑	D	↑	T	↑	d	↑	t	↑									
0	1	0	1	5	ENQ	*3 PPC	NAK	PPU	%	↑	5	↑	E	↑	U	↑	e	↑	u	↑									
0	1	1	0	6	ACK		SYN		&	↑	6	↑	F	↑	V	↑	f	↑	v	↑									
0	1	1	1	7	BEL		ETB		'	↑	7	↑	G	↑	W	↑	g	↑	w	↑									
1	0	0	0	8	BS	GET	CAN	SPE	(↑	8	↑	H	↑	X	↑	h	↑	x	↑									
1	0	0	1	9	HT	TCT	EM	SPD)	↑	9	↑	I	↑	Y	↑	i	↑	y	↑									
1	0	1	0	10	LF		SUB		*	↑	:	↑	J	↑	Z	↑	j	↑	z	↑									
1	0	1	1	11	VT		ESC		+	↑	:	↑	K	↑	[↑	k	↑	{	↑									
1	1	0	0	12	FF		FS		,	↑	<	↑	L	↑	*4	↑	l	↑		↑									
1	1	0	1	13	CR		GS		-	↑	=	↑	M	↑]	↑	m	↑	}	↑									
1	1	1	0	14	SO		RS		.	↑	>	↑	N	↑	^	↑	n	↑	~	↑									
1	1	1	1	15	SI		US		/	↑	?	↑	UNL	↑	O	↑	_	↑	DEL	↑									
					Address command group (ACG)					Universal command group (UCG)					Listener address group (LAG)					Talker address group (TAG)									
										Primary command group (PCG)										Secondary command group (SCG)									

Figure 7.1 Multi-Line Interface Message

- Note: *1 MSG means an interface message
 *2 b1=DIO1...b7=DIO7. DIO8 is not used
 *3 Accompanied by the secondary command
 *4 "\" for IEC standard, "¥" for JIS
- | | |
|-------------------------------|---------------------------------|
| GTL : Go To Local | TCT : Take Control |
| SDC : Selected Device Clear | LLO : Local Lockout |
| PPC : Parallel Poll Configure | DCL : Device Clear |
| GET : Group Execute Trigger | PPU : Parallel Poll Unconfigure |
| | SPE : Serial Poll Enable |
| | SPD : Serial Poll Disable |
| | UNL : Unlisten |
| | UNT : Untalk |

7.6 List of functions supported by LXI

(Recommendation and Permission)

LXI Version 1.4 Core 2011

Section	Function	Correspondence
7.1.1	Gigabit Ethernet	×
7.2.1	MAC Address Visible While in Rack	○
7.4	Incorporate Auto-MDIX	○
7.6.1	Provide Override for Auto-Negotiation	×
8.1.1	LXI Devices should also support IPv6 to ensure long-term network compatibility	×
8.4	Provide Way to Disable ICMP Ping Responder	×
8.5	Support ICMP Ping Client	×
8.6.2	30-Second DHCP Timeout	×
8.6.4	Accept the First DHCP Offer Received	○
8.6.5.1	Additional DHCP Options Allowed for LXI Device Updates	×
8.6.8	Provide Manual DNS IP Address Entry	×
8.6.9	User Configured Hosts File Allowed	×
8.8	Check Network Configuration Values for Validity	○
8.9	Single Hostname for All Naming Services	○
8.11	Support Dynamic DNS Hostname Registration	×
8.11.1	Provide User Control of Dynamic DNS Registration	×
8.12	Provide DNS Client	×
8.13.1	LAN Configuration Initialize (LCI) Additional Settings	○
9.1.2	Web Server Root Document	○
9.2.1.1	LXI Device Address String Label	○
9.2.2	Web Page Title	×
9.2.3.1	How To Determine Actual Hostname with Unicast DNS	×
9.2.3.4	If both DNS and mDNS are enabled	×
9.3.1	No password protection for device identification indicator	○
9.4.1	Status Page Link on the Welcome Page	×
9.5.1	Default Description for LXI Device	○

7.6 List of functions supported by LXI

9.5.2	Auto-Negotiate Enable/Disable Through Web Page	○
9.5.3	Ping Enable/Disable Through Web Page	○
9.5.4	Other Information on the LAN Configuration Page	○
9.5.5	Disable Switch for LAN Configuration Page	×
9.5.6	mDNS Enable/Disable Through Web Page	○
9.7	Status Web Page Contents	×
9.7.1	Other Information on the Status Web Page	×
9.8.1	Blank password	○
9.10	LXI Web Interface Example	×
9.11	LXI Device Control Using Web Page	○
9.12	Software/Firmware Upgrade Using Web Interface	○
9.13	LXI Glossary	○
10.1.2.1	Additional VXI-11 and SCPI Support Is Optional	×
10.2.1	HTTP Redirection	×
10.3.2	Default mDNS Hostname	○
10.4.2.2	Default Service Name	○
10.4.3.5	TXT Record Key Default Values	×
10.4.3.9	Maximum Length of TXT Record	○
10.4.3.10	Additional Service Advertisements	○
10.4.3.12	Additional Service Advertisement Order	×

WABUN: (DA00030862-002)

NOTES

- Reproduction of the contents of this manual is forbidden by applicable laws.
- The contents of this manual may be revised without notice.
- Information provided in this manual is intended to be accurate and reliable. However, we assume no responsibility for any damage regarding the contents of this manual.
- Should you notice any doubtful or wrong statement, or lack of description, please contact us or our agent.

©Copyright 2011-2018, **NF Corporation**

PROGRAMMABLE AC/DC POWER SOURCE KP3000S INSTRUCTION MANUAL (Remote Control)

NF Corporation

6-3-20, Tsunashima Higashi, Kohoku-ku, Yokohama
223-8508 JAPAN

Phone +81-45-545-8111 Fax +81-45-545-8187

