



FREQUENCY RESPONSE ANALYZER

FRA51615

**INSTRUCTION MANUAL
(OPERATIONS)**

NF Corporation

DA00061633-004

FREQUENCY RESPONSE ANALYZER

FRA51615

**INSTRUCTION MANUAL
(OPERATIONS)**

Registered Trademarks

National Instruments, LabVIEW, and Measurement Studio are registered trademarks of National Instruments Corporation in the United States.

WINDOWS® EMBEDDED 8.1 INDUSTRY PRO

Used with permission from Microsoft.

Other company names and product names used in this instruction manual may be trademarks or registered trademarks of their respective companies.

Copyright

NI Measurement Studio

Copyright (C) 2010 National Instruments Corporation

All Rights Reserved.

— Preface —

Thank you for purchasing the "FRA51615 FREQUENCY RESPONSE ANALYZER".

For safe and correct use of this product, please read the "Safety Precautions" section that follows before attempting to use the instrument.

■ Marks and symbols

For safe operation by the user and to prevent damage to the instrument, please give attention to the following marks and symbols that are used in this manual.

WARNING

This mark indicates information for preventing the possibility of death or serious personal injury from electrical shock or other hazards or damage to the instrument in the use or handling of this instrument.

CAUTION

This mark indicates information for preventing the possibility of injury to the user or damage to the instrument and the use for handling of this instrument.

■ The scope of this Manual

This manual describes the FRA51615 that conform to requirements of CE Marking.

Products without CE Marking affixed, may not meet directives for CE Marking (EMC and others).

Please confirm the CE Marking is affixed on the rear panel.

- The manuals provided for the FRA51615 are listed below.
 - Instruction manual (Operations)

This manual describes operation of the FRA51615 from the instrument's control panel, specifications, maintenance, and other basic matters.
 - Instruction manual (Remote Control)

This manual describes remote control of the FRA51615
- The chapters of this manual are described below

If you're using this equipment for the first time, begin reading from Chapter 1.

1. Introduction

This chapter provides a general description of the instrument, including its features, applications, functions, and basic operating principles.

2. Preparation before use

This chapter describes important preparation that must be done before operating the instrument.

3. Panel operations

This chapter explains the function, operating procedure, default values, and measurement values for each part of the display screen. Read this chapter for a quick overall understanding of the panel and its use.

4. Basic operation

This chapter explains the basic operating procedures of the FRA51615. Refer to this chapter as you use the instrument.

5. Advanced operation

This chapter explains a wider range of operations.

6. File formats

This chapter explains the various file formats for saving data in external storage devices (USB memory).

7. Troubleshooting

This chapter describes how to deal with error messages and cases in which you think the instrument is malfunctioning.

8. Maintenance

This chapter explains maintenance, repacking, transportation, and performance testing methods.

9. Specifications

This chapter describes the instrument specifications (functions and performance).

———— Safety Precautions ————

For safe use of this product, give full attention to the following warnings and cautions.

The NF Corporation shall not be held liable for damages that arise from failure to observe these warnings and cautions.

This product is a Class I device (with protective conductor terminals) that conforms to the IEC insulation standards.

- Be sure to observe the instructions in the instruction manual.

This instruction manual contains information for the safe operation and use of this product.

Read the instructions and information before using the product.

All of the warning items contained in this instruction manual are intended to avoid risks that may lead to serious accidents. Follow the warnings and instructions carefully.

- Be certain that the product is properly grounded.

This product uses a line filter which may cause electric shock if the product is not grounded.

To prevent electrical shock accidents, connect the product to an earth ground so that ground resistance is 100 Ω or less.

This product is automatically grounded by connecting a 3-pin power plug to a power outlet with a protective ground contact.

- Check the power supply voltage.

This instrument operates on the power source voltage described in "2.3 Grounding and Power Connections".

Before plugging in the power cord, confirm that the outlet voltage conforms to the rated voltage of this instrument.

- If you think something is wrong, ...

If smoke or an unusual odor or sound comes from the instrument, immediately remove the power cord from the socket and cease use of the instrument.

If any such abnormality occurs, take measures to prevent the use of the instrument until repairs have been completed and promptly contact the NF Corporation or its authorized agent.

- Do not use this product when gas is present.

Operating the instrument in the presence of flammable gases may cause an explosion.

- Do not open the product case.

To prevent exposure to high voltages, never remove the cover of the instrument.

Only technicians certified by the NF Corporation are authorized to inspect or touch anything inside the product case.

- Do not modify this product.

Never modify this product in any way. Modification might create new risks. The NF Corporation may refuse to service an instrument that has an unauthorized modification.

- Do not expose this product to water.

Use of this product when it is wet may result in electrical shock or fire. If the instrument becomes wet, immediately unplug the power cord and contact the NF Corporation or its authorized agent.

- If lightning occurs nearby, turn off the power switch and unplug the power cord.

A lightning strike may cause electrical shock, fire, or instrument malfunction.

- Safety-related symbols

The marks and codes defined below are used in this manual or on the instrument itself to indicate safety information or instructions.



Instruction manual reference symbol

This notifies the user of a potential hazard and indicates that the user must refer to the instruction manual.



Electric shock danger symbol

This symbol indicates a location that presents a risk of electric shock under specific conditions.



Warning symbol

This contains information to avoid risks when handling the equipment that could result in the death or serious injury of the operator.



Caution symbol

This contains information to avoid risks when handling the equipment that could result in minor or moderate injury of the operator or damage to property.

- Other symbols



Indicates that the "ON" position of the power switch



Indicates the "OFF" position of the power switch



Indicates that the outer conductor of the connector is connected to the instrument enclosure.

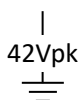

Indicates that the outer conductor of the connector is insulated from the instrument enclosure.

However, safe operation of the instrument requires that the potential difference from the grounding potential is restricted to 42 Vpk or less.



Indicates that the outer conductor of the connector is insulated from the instrument enclosure.

However, the potential difference from ground or from the line neutral point must be 600 V or less and restricted to MEASUREMENT CATEGORY II at the mains.

This product is grounded when in use, so the electrical potential of the instrument enclosure is equal to the ground potential.

- **MEASUREMENT CATEGORIES**

MEASUREMENT CATEGORIES specified by IEC61010-2-030 may be specified for the measurement connectors and other connectors of this instrument based on the location on the mains that is being measured. The relevant MEASUREMENT CATEGORIES are listed below.

MEASUREMENT CATEGORY IV (CAT IV):

Circuits connected to the source of the building's low-voltage mains installation

MEASUREMENT CATEGORY III (CAT III):

Circuits connected to the distribution part of the building's low-voltage mains installation

MEASUREMENT CATEGORY II (CAT II):

Circuits connected directly to utilization points of the low-voltage mains installation

No MEASUREMENT CATEGORY:

Circuits not intended to be directly connected to the mains

- **Electromagnetic compatibility**

Applied EMC standard: EN 61326-1, EN 61326-2-1

Intended electromagnetic environment: Industrial

Emissions, which exceed the levels required by that standard, can occur when this product is connected to a test object.

This product is a CISPR 11 Group 1 Class A equipment.

This product may cause interference if used in residential areas. Such use must be avoided unless the user takes special measures to reduce electromagnetic emissions to prevent interference to the reception of radio broadcasts.

⚠ CAUTION

This product is not intended for use in residential environments and may not provide adequate protection to radio reception in such environments.

- **Disposal of this product**

To protect the environment, follow the guidelines described below for the disposal of this product.

a) This device is equipped with a lithium battery. Use the services of an industrial waste disposal contractor to dispose of such batteries.

b) The LCD backlight module that is used in this product does not contain mercury.

c) Use the services of an industrial waste disposal contractor for disposal of the entire product.

Contents

	Page
1. Introduction.....	1-1
1.1 Features.....	1-2
1.2 Applications	1-3
1.3 Operating principles.....	1-6
2. Preparation before use	2-1
2.1 Inspection	2-2
2.2 Installation.....	2-5
2.3 Grounding and power connections	2-11
2.4 Quick operation check	2-13
2.5 Calibration.....	2-14
3. Panel operations.....	3-1
3.1 Function and use of each part of the panels	3-2
3.2 Input and output connectors	3-9
3.3 Outline of operation screen.....	3-20
3.4 Operation tree.....	3-33
3.5 Operation screen reference	3-39
3.6 Initial settings	3-88
4. Basic operation.....	4-1
4.1 Display and operation for powering up.....	4-2
4.2 Simple operation for the first use	4-5
4.3 Oscillator settings	4-14
4.4 Integration.....	4-18
4.5 Measurement control	4-20
4.6 Graph display mode.....	4-22
4.7 High-frequency measurements.....	4-27
5. Advanced operation.....	5-1
5.1 Analysis mode	5-2
5.2 Delay.....	5-3
5.3 Input settings	5-5
5.4 Oscillator control	5-8
5.5 Graph display.....	5-12
5.6 Marker operations	5-20
5.7 Amplitude compression.....	5-26
5.8 Automatic high density sweep	5-29
5.9 Error correction	5-31

5.10	Differentiation and integration function.....	5-51
5.11	Sequence measurement.....	5-52
5.12	Memory operations	5-54
5.13	External reference clock	5-64
5.14	Other operations	5-66
6.	File formats.....	6-1
6.1	Overview.....	6-2
6.2	Measurement data file format	6-2
6.3	Measurement conditions file format	6-6
6.4	Screen capture file format.....	6-10
7.	Troubleshooting.....	7-1
7.1	Error messages	7-2
7.2	Information messages.....	7-6
7.3	Quick diagnosis	7-8
8.	Maintenance	8-1
8.1	Introduction	8-2
8.2	Daily maintenance	8-3
8.3	Storage, repacking, and transportation	8-3
8.4	Checking the version number	8-3
8.5	Performance test	8-4
8.6	Calibration.....	8-14
9.	Specifications.....	9-1
9.1	Oscillator section	9-2
9.2	Analysis input section	9-4
9.3	Measurement processing section	9-6
9.4	Analysis processing section.....	9-9
9.5	Display section.....	9-16
9.6	Memory.....	9-16
9.7	External memory.....	9-17
9.8	External input/output function	9-17
9.9	Miscellaneous specifications.....	9-19

Figures and Tables

	Page
Figure 1-1 Example of gain-phase characteristic measurement	1-3
Figure 1-2 Example of loop gain measurement	1-4
Figure 1-3 Example of impedance characteristic measurement	1-5
Figure 1-4 Principal of frequency transfer characteristic measurement with the FRA51615.....	1-6
Figure 1-5 Block diagram	1-7
Figure 2-1 Rack mounting kit assembly diagram (JIS).....	2-7
Figure 2-2 Rack mounting kit assembly diagram (EIA)	2-8
Figure 2-3 Rack mounting kit dimensions (JIS).....	2-9
Figure 2-4 Rack mounting kit dimensions (EIA)	2-10
Figure 3-1 Front panel.....	3-2
Figure 3-2 Rear panel	3-3
Figure 3-3 Isolation rating of the analyzer input connectors	3-9
Figure 3-4 Isolation withstand voltage of the analysis module input connectors by frequency.....	3-10
Figure 3-5 Maximum input voltage of the analysis module input connectors by frequency.....	3-11
Figure 3-6 Isolation rating of the oscillator output connector.....	3-12
Figure 3-7 Isolation withstand voltage of the oscillator output connector by frequency.....	3-13
Figure 3-8 Isolation withstand voltage between signal connectors	3-14
Figure 3-9 Isolation withstand voltage between the signal connectors by frequency	3-15
Figure 3-10 Screen immediately after startup	3-20
Figure 3-11 Top menu	3-22
Figure 3-12 Top menu switching	3-22
Figure 3-13 Example of a settings dialog	3-23
Figure 3-14 Navigating the menu hierarchy	3-23
Figure 3-15 Graph display styles	3-32
Figure 4-1 Connections for loop gain measurement	4-6
Figure 4-2 Example of connections for measuring the loop gain of a DC-DC converter	4-6
Figure 4-3 Nyquist plots obtained from actual measurements	4-9
Figure 4-4 Example of connections for gain-phase measurement.....	4-10
Figure 4-5 Example of connections for transfer characteristic measurement.....	4-10
Figure 4-6 Example of connections for measuring impedance	4-11
Figure 4-7 Example of connections for measuring impedance with high-power	4-13
Figure 5-1 Example of a response waveform that requires a delay	5-3
Figure 5-2 Change in output voltage for the SLOW setting.....	5-8
Figure 5-3 Oscillation stop mode setting and change in output voltage	5-9

Figure 5-4	Frequency change mode and waveform change	5-10
Figure 5-5	Graph display styles	5-12
Figure 5-6	Example of phase measurements	5-16
Figure 5-7	Example of marker search (Bode plot, MAX / MIN / PEAK / BOTTOM)	5-21
Figure 5-8	Example of marker search (Bode plot, Y1 VALUE).....	5-22
Figure 5-9	Example of marker search (Bode plot, Δ Y1 VALUE)	5-22
Figure 5-10	Example of marker search (Nyquist plot, X MAX / PEAK / VALUE).....	5-22
Figure 5-11	Example of marker search (Nyquist plot, Δ X)	5-23
Figure 5-12	Example of using amplitude compression (gain-phase measurement).....	5-26
Figure 5-13	Example of using amplitude compression (impedance measurement).....	5-26
Figure 5-14	Operation for amplitude	5-27
Figure 5-15	Example of measurement using the automatic high density sweep.....	5-29
Figure 5-16	Error correction data flow.....	5-31
Figure 5-17	Connections for calibration	5-32
Figure 5-18	Operation of the potential slope elimination function	5-34
Figure 5-19	Examples of potential fluctuation waveforms that cannot be eliminated	5-35
Figure 5-20	Example of connections for gain-phase measurement	5-38
Figure 5-21	Example of connections for systematic error	5-38
Figure 5-22	Impedance measurement connection example (2-port connection)	5-41
Figure 5-23	Operation of the open correction and short correction functions.....	5-42
Figure 5-24	Connections for open correction and short correction	5-42
Figure 5-25	Load correction operation	5-46
Figure 5-26	Conversion among displacement, speed, and acceleration by differentiation and integration.....	5-51
Figure 6-1	Structure of the measurement data file (no sequence measurement)	6-2
Figure 6-2	Structure of the measurement data file (with sequence measurement).....	6-3
Figure 6-3	Structure of the measurement conditions file	6-6
Figure 9-1	Isolation voltage specifications relative to the enclosure	9-6
Figure 9-2	Isolation voltage specifications between signal connectors	9-6
Figure 9-3	External dimensions	9-20

Table 2-1	Packing list	2-2
Table 3-1	Initial settings 1/8.....	3-88
Table 4-1	Display modes for display unit GAIN	4-22
Table 4-2	Display modes for display unit IMPEDANCE	4-23
Table 4-3	Graph axis parameters for display unit GAIN	4-24
Table 4-4	Graph axis parameters for display unit IMPEDANCE.....	4-24
Table 4-5	Display parameter conversion formulas for display unit GAIN.....	4-25
Table 4-6	Display parameter conversion formulas for display unit IMPEDANCE	4-26
Table 5-1	Error due to potential slope (theoretical values)	5-34
Table 6-1	Data file format (header)	6-3
Table 6-2	Data file format (measurement conditions part).....	6-4
Table 6-3	Data file formats (measurement data part)	6-5
Table 6-4	Measurement conditions file format (header)	6-6
Table 6-5	Measurement conditions file format (measurement conditions part)	6-6
Table 7-1	Power-up errors.....	7-2
Table 7-2	Panel operation errors	7-3
Table 7-3	Errors that occur during measurement	7-5
Table 7-4	Other errors	7-5
Table 7-5	Messages presented at start-up	7-6
Table 7-6	Messages presented during operation	7-6
Table 7-7	Troubleshooting.....	7-8

1. Introduction

1.1	Features	1-2
1.2	Applications	1-3
1.3	Operating principles	1-6
1.3.1	Basic principles	1-6
1.3.2	Block diagram	1-7

1.1 Features

The "FRA51615 FREQUENCY RESPONSE ANALYZER" measures the loop gain frequency characteristics of circuits such as inverters and switching power supplies by frequency sweeping. The instrument has a sweep oscillator that uses the synthesizer method for driving the circuit being measured, an analyzer for measuring the response of the circuit being measured to the driving signal and obtaining gain and phase data, and a display screen for presenting the results. In addition to measuring the loop gain of inverters, switching power supplies, and DC-DC converters, and mechanical servo characteristics, the instrument can also measure the gain-phase characteristics of electronic circuits.

(1) High accuracy and wide dynamic range

The internal oscillator of the instrument maintains high frequency accuracy and resolution by using the synthesizer method. The analyzer ensures a wide dynamic range with a high-resolution A/D converter and an automatic ranging function.

(2) Isolated input and output connectors

The two analysis inputs and oscillator outputs are independently isolated from the instrument enclosure (600 V CAT II/300 V CAT III).

(3) Wide frequency range (10 μ Hz to 15 MHz)

This instrument can measure across a 10 μ Hz to 15 MHz frequency range with a single sweep.

(4) Impedance measurement function

Combined with a power amplifier, or shunt resistance, etc., this instrument can measure impedance over a much wider range of voltage/current than a normal LCR meter is capable of handling.

(5) Color LCD and touch panel

The frequency characteristic graph and measurement condition setting menu are displayed on a color LCD that is equipped with a touch panel. Various settings and operations can be performed intuitively by touching the screen.

(6) High-speed measurement (as fast as 0.5 ms per data point)

Frequency sweeping is performed at up to 0.5 ms per data point. This performance contributes to shortening the Takt time.

(7) GPIB/USB/RS-232/LAN interface as standard equipment

It is possible to set measurement conditions and read measurement data with an external personal computer.

1.2 Applications

This instrument features isolated input and output and highly-accurate measurement over a wide dynamic range, enabling application in a variety of fields such as those listed below.

- | | |
|------------------------------|--|
| ● Power electronics | Loop characteristic measurement of inverters, switching power supplies, etc. |
| ● Contactless power supplies | Frequency characteristic measurement of transmission coils and driver amplifiers |
| ● Servo systems | Servo characteristic measurement of optical disk drives, robots, camera lens control systems, etc. |
| ● Electronic circuits | Frequency characteristic measurement of filters, and amplifiers, etc.
Loop characteristic measurement of DC-DC converters |
| ● Electronic components | Frequency characteristic measurement of coils, capacitors, and other electronic components |
| ● Audio equipment | Frequency characteristic measurements of speakers, microphones, etc. |
| ● Vibration analysis | Measurement of resonance characteristics |

■ Example of frequency response characteristic measurement

An example of measuring frequency response characteristics (gain-phase characteristics) for amplifiers, filters, and other such circuits is illustrated in Figure 1-1. The setup includes the sweep oscillator (OSC), the equipment under test (EUT), and two measurement channels (CH1 and CH2).

The gain and phase of the EUT are obtained by measuring the input voltage from CH2, measuring the output voltage from CH1, and dividing the measured output voltage by the input voltage. By taking the measurements while sweeping the OSC frequency, the frequency characteristic is obtained automatically and displayed in graph form on the LCD of the instrument.

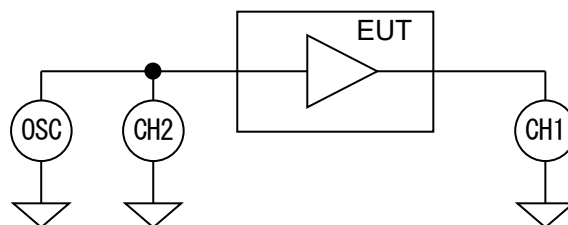

Figure 1-1 Example of gain-phase characteristic measurement

■ Example of loop gain characteristic measurement

The loop gain characteristic is obtained by injecting a perturbation signal into a negative feedback loop and measuring the response to the perturbation signal.

The internal signal generator of the instrument is in a floating state with respect to the enclosure, so it is possible to measure the linking characteristic without using an isolation transformer for signal injection.

The high withstand voltage isolation of up to 600 V (CAT II) enables measurement on the primary side of inverters and switching power supplies that are connected directly to the mains.

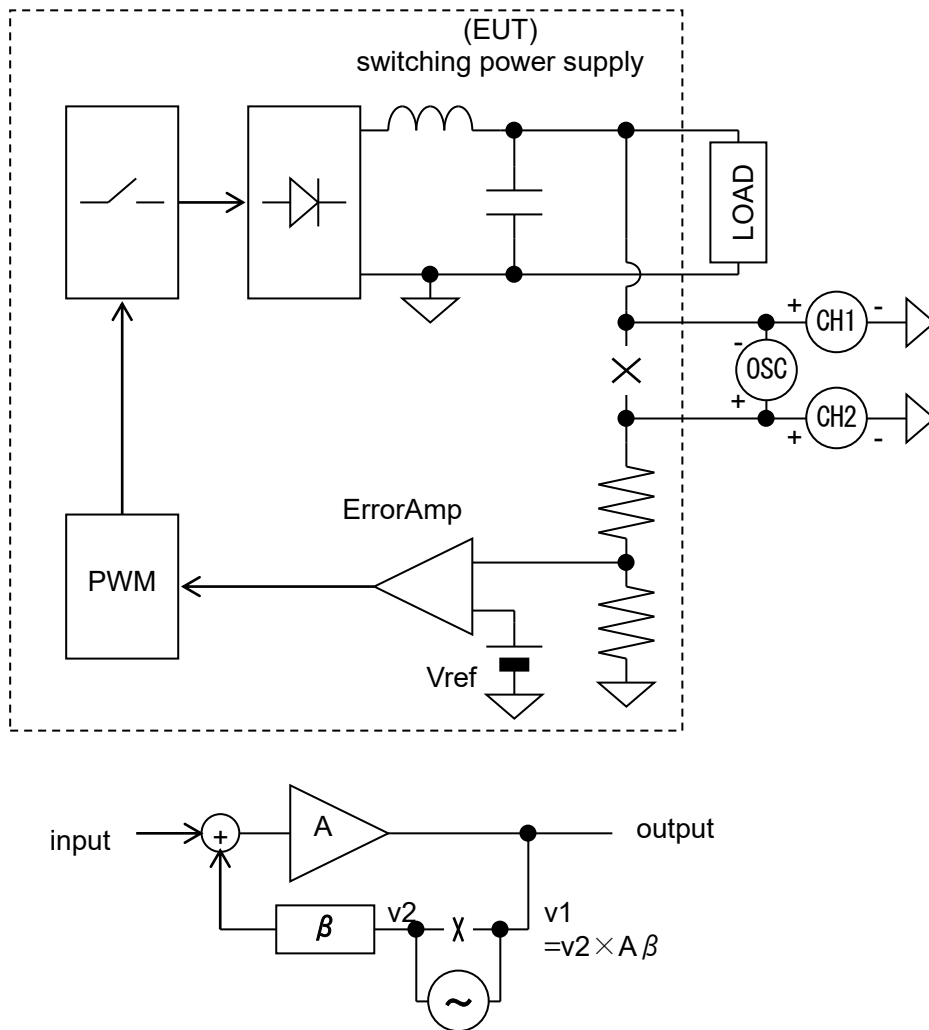

Figure 1-2 Example of loop gain measurement

By measuring the characteristics with this instrument, it is possible to obtain the phase margin, gain margin, and other indices that are needed to determine negative feedback loop stability.

■ Example of impedance characteristic measurement

The impedance of the DUT can be measured by using this instrument to measure the voltage (v) with CH1 and the current (i) with CH2, and calculating the impedance by taking the vector ratio of CH1 and CH2.

The current of the DUT (i) is converted to a voltage with a shunt resistance, current probe, or CT, etc., and the voltage is input to CH2.

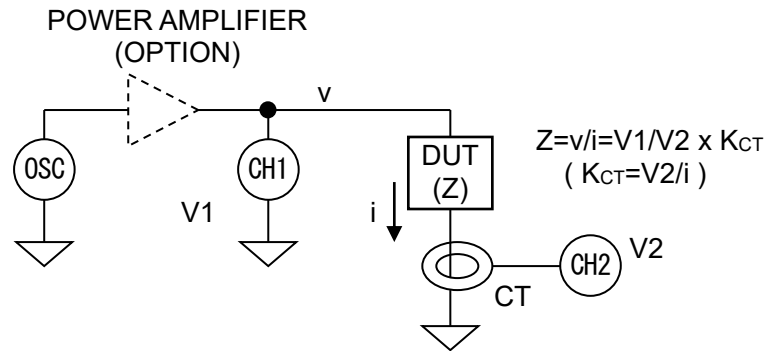

Figure 1-3 Example of impedance characteristic measurement

It is possible to measure the impedance of the DUT at high voltage or large current by amplification of the output of the sweep oscillator with the power amplifier as needed. This instrument differs from LCR meters, impedance analyzers, and other such devices that limit the signal level to less than 1 V in that measurement is possible under the signal amplitude conditions actually used by the EUT, thus enabling evaluation of materials that handle high energy levels, such as magnets and dielectrics.

1.3 Operating principles

1.3.1 Basic principles

The Frequency Response Analyzer (FRA) measures the frequency transfer characteristics of the equipment under test (EUT) with high accuracy over a wide dynamic range. It is equipped with a sweep oscillator and two analysis input channels (CH1,CH2), and makes highly-accurate calculations of analysis frequency component vectors (amplitude and phase) from Fourier coefficients obtained from a discrete Fourier transform of the input signals. By measuring the EUT input signal (V_{in}) and output signal (V_{out}) with the analysis input channels (CH1 and CH2) and calculating the vector ratio (CH1/CH2), the gain and phase at the analysis frequency (f) of the EUT can be obtained.

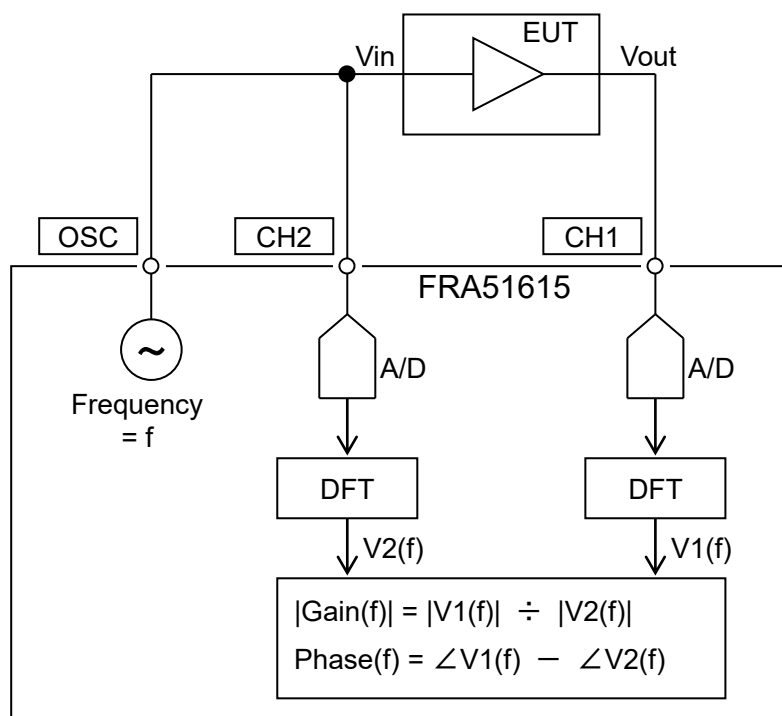

Figure 1-4 Principal of frequency transfer characteristic measurement with the FRA51615

The loop characteristic measurement and impedance characteristic measurement both differ from the gain-phase measurement only in the connections and the units of the measurement results, so the measurement principle is the same as for the gain-phase measurement described above.

One round of measurement produces the gain and phase values at the analysis frequency (f). By measuring the gain and phase while sweeping the oscillator and analysis frequencies, frequency characteristics such as Bode plots can be obtained. Also, when auto-range is set, the range of the analysis module is optimized for each frequency being measured, so the dynamic range is greatly increased for measurement of A/D converters.

1.3.2 Block diagram

In this section, schematic block diagrams of the instrument are presented and the main functions are explained.

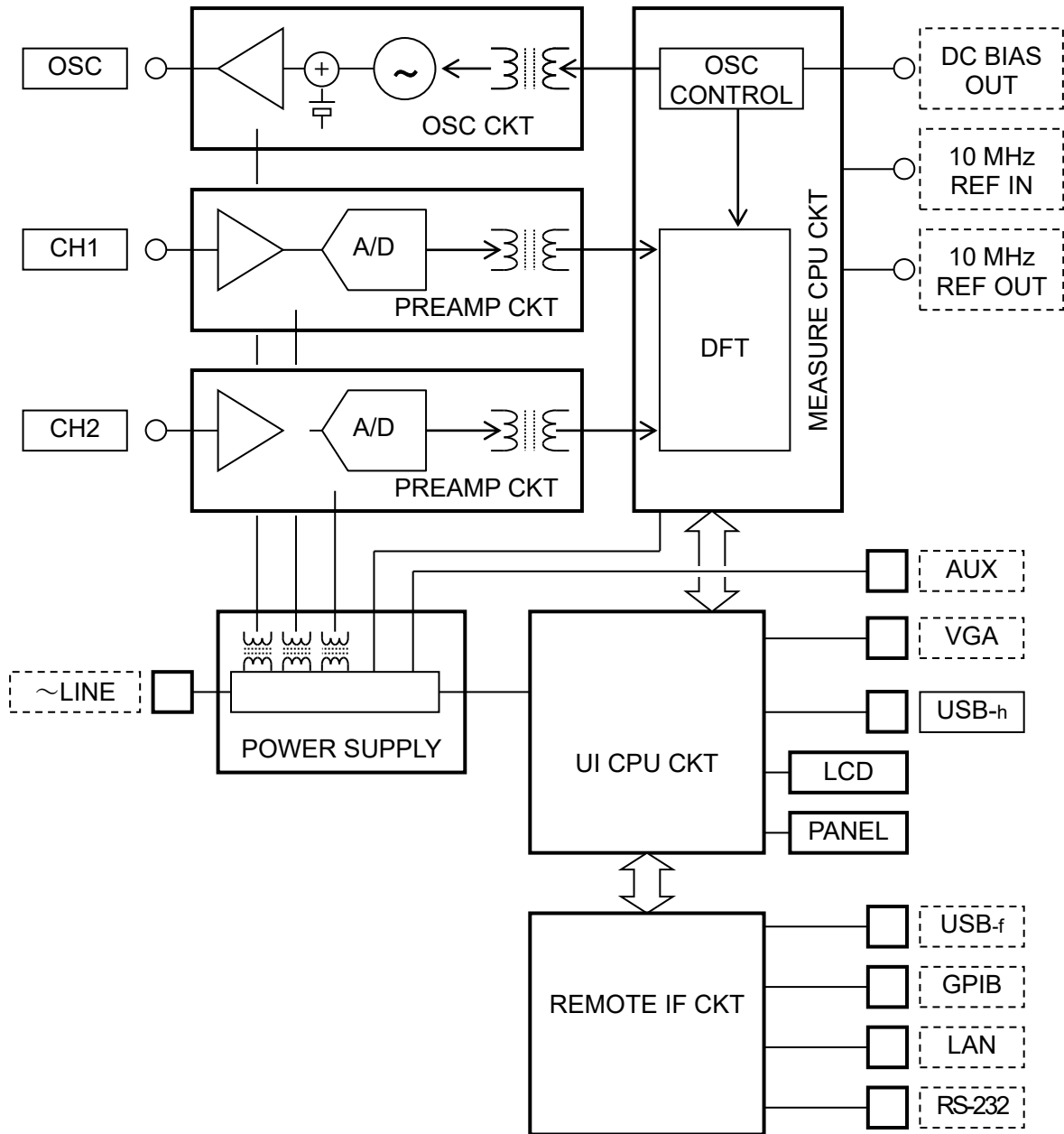

Figure 1-5 Block diagram

a) OSC CKT

This is the oscillator that generates the measurement signal for the instrument. The synthesizer uses a digital direct synthesis method to have a setting resolution of 10 μ Hz in the range from 10 μ Hz to 15 MHz. The synthesizer features both immediate frequency change and phase continuity. This instrument is also equipped with a function for stopping oscillation at 0° phase and a function for changing frequency at 0° phase, and can thus suppress effects on the equipment under test to the minimum.

b) PREAMP CKT

This is the analysis module that comprises a variable attenuator, variable-gain amplifier, and an A/D converter. It has two input channels (CH1 and CH2). The DC component of the input signal is removed and the signal is amplified (or attenuated) to an appropriate level before 16-bit A/D conversion. Both channels have a maximum input voltage of 600 V and are rated for MEASUREMENT CATEGORY II (CAT II). (The maximum voltage for CAT III is 300 V).

The OSC output and the inputs for CH1 and CH2 are isolated from the enclosure and the terminals are isolated from each other with an insulation rating of 600 V CAT II or 300 V CAT III. Although it is possible to take measurements on circuits that are connected to the primary side of the mains, it is necessary to use the rated voltage and over-voltage category.

c) MEASURE CPU CKT

This performs OSC CKT and PREAMP CKT configuration and control. It also performs discrete Fourier transform (DFT) processing of the digital data after A/D conversion of the signal by PREAMP CKT, conversion to gain and phase or impedance, and various types of error correction. The error-corrected measurement data is sent to UI CPU CKT.

d) UI CPU CKT

This module displays the measurement data received from MEASURE CPU CKT on the LCD screen in various graph formats. It also sends measurement commands to MEASURE CPU CKT according specifications from the front panel and remote interfaces. The USB-_H connector on the front panel is used for connection of memory devices.

e) POWER SUPPLY CKT

In addition to supplying power to the digital modules and control module, this module provides a high-impedance isolated power supply to CH1, CH2, and OSC.

f) REMOTE IF CKT

This module performs communication with external controllers for the output of various types of settings and measurement data. It converts between the communication protocols of the GPIB, USB, RS-232, and LAN general interfaces and the internal communication protocol of UI CPU CKT. The USB_f connector is located on the rear panel and is used for connection to a personal computer that can serve as a controller for this instrument.

(Blank)

2. Preparation before use

2.1	Inspection.....	2-2
2.2	Installation.....	2-5
2.2.1	General cautions	2-5
2.2.2	Installation environment.....	2-5
2.2.3	Rack mounting.....	2-6
2.3	Grounding and power connections.....	2-11
2.4	Quick operation check.....	2-13
2.5	Calibration.....	2-14

2.1 Inspection

■ Safety check

Before using this product, read the "Safety Precautions" section at the beginning of this manual and perform the safety checks described there.

Before connecting the instrument to a power supply, read "2.3 Grounding and power connections" and perform all safety checks fully.

■ Packing check

First check for any damage that may have occurred during transportation.

After unpacking the equipment, refer to "Table 2-1 Packing list" and confirm that all items are present in the quantities listed.

Table 2-1 Packing list

Main unit	1
Accessories	
Instruction Manual (operation)	1
Instruction Manual (remote control)	1
Power cord set (2 m, with three-pin plug)	1
Signal cables (BNC-BNC, 50Ω, 1m, 600V CAT II)	3
Calibration cables (BNC-BNC, 50Ω, 20 cm)	2
BNC adapter (600V CAT II)	1

* The included signal cable is the same product as the "PC-002-3347 High withstand voltage BNC cable" (optional).

* The included BNC adapter is the same product as the "PC-001-4503 High withstand voltage BNC adapter (T-branch)" (optional).

* The included calibration cable is the same product as the "PA-001-3059 HIGH WITHSTAND VOLTAGE BNC CABLE SET (20 cm, 2 CABLES)" (optional).

* Impedance measurement cannot be performed with this instrument alone. The optional accessories listed below may be required. For more information, contact NF Corporation or its authorized agent.

■ Optional accessories

PC-002-3347 High withstand voltage BNC cable

A high withstand voltage BNC cable (1m) that can be used for 600 V CAT II or 300 V CAT III.

PA-001-3059 HIGH WITHSTAND VOLTAGE BNC CABLE SET (20 cm, 2 CABLES)

A two-cable set of high withstand voltage BNC cables (20 cm) that can be used for 600 V CAT II or 300 V CAT III.

PC-001-4503 High withstand voltage BNC adapter (T-branch)

A high withstand voltage BNC adapter that can be used for 600 V CAT II or 300 V CAT III.

PA-001-0419 High withstand voltage clip cable set (3 per set)

A high withstand voltage clip cable (1m) that can be used for 600 V CAT II or 300 V CAT III.

PA-001-0421 High withstand voltage alligator clip cable set (large) (3 per set)

A set of three high withstand voltage alligator clip cables (1m) that can be used for 600 V CAT II or 300 V CAT III.

PC-007-0364 High withstand voltage extension BNC cable

A high withstand voltage BNC extension cable (1 m) that can be used for 600 V CAT II or 300 V CAT III.

PA-001-3058 HIGH WITHSTAND VOLTAGE BNC EXTENSION CABLE SET (15 cm, 3 CABLES)

A set of three high withstand voltage BNC extension cables (15 cm) that can be used for 600 V CAT II or 300 V CAT III.

The following optional accessories have restrictions concerning the circuits for which safe measurement as possible when used together with this instrument.

PA-001-0420 High withstand voltage alligator clip cable set (small) (3 per set)

A set of three high withstand voltage small alligator clip cables (1m) that can be used for 300 V CAT II or less.

The following optional accessories are restricted to circuits that have no MEASUREMENT CATEGORY and 42 Vpk or less for safe measurement when used together with this instrument.

5055 SIGNAL INJECTOR / PROBE

A probe for servo loop measurements of circuits (limit to 11 V) that have low stray capacitance.

PA-001-0368 IMPEDANCE MEASUREMENT ADAPTER

An adapter for use in measuring the impedance of electronic components, etc.

To protect the BNC connector of the instrument, use of the "PA-001-3058 HIGH WITHSTAND VOLTAGE BNC EXTENSION CABLES SET (15 cm, 3 CABLES SET)" for connection is recommended.

PA-001-0369 LOOP GAIN MEASUREMENT ADAPTER

An adapter that simplifies wiring connections for servo loop measurements.

To protect the BNC connector of the instrument, use of the "PA-001-3058 HIGH WITHSTAND VOLTAGE BNC EXTENSION CABLES SET (15 cm, 3 CABLES SET)" for connection is recommended.

PA-001-1838 TEST FIXTURE ADAPTER (1 ohm)

PA-001-1839 TEST FIXTURE ADAPTER (100 ohm)

An adapter for connecting to various LCR meter test fixtures for measuring the impedance of electronic components.

PA-001-0422 Alligator clip cable set (3 per set)

The options listed below have an isolation withstand voltage or maximum measurement voltage as 42 Vpk or more, but they do not have a measurement category and so cannot be used for measuring circuits that are directly connected to the main power supply.

PA-001-0370 SHUNT RESISTOR

An shunt resistor (1 ohm). Maximum current 1A, Isolation withstand voltage of 250 Vrms, no measurement category.

PA-001-1840 HI-POWER IMPEDANCE MEASUREMENT ADAPTER (1 ohm)

PA-001-1841 HI-POWER IMPEDANCE MEASUREMENT ADAPTER (100 ohm)

An adapter for measuring the impedance of a sample at up to 250 Vrms using a power amplifier. No isolation.

For more information refer to the respective product manuals.

PA-001-3036 RACK MOUNT KIT (EIA)

This is the kit for mounting the instrument on an EIA standard rack.

PA-001-3037 RACK MOUNT KIT (JIS)

This is the kit for mounting the instrument on a JIS standard rack.

■ Thermal printer

A hard copy of what is displayed on the LCD screen of the instrument can be printed out by connecting a thermal printer to the USB port on the front panel of the instrument.

Manufacturer	Seiko Instruments Inc.
Product name	Thermal printer
Model	DPU-S445-00B-E

Only the printer described above can be used.

The NF Corporation does not handle this product. For more information, please refer to the product instruction manual.

 **WARNING**

There are locations of high-voltage inside this product. Do not remove the cover of this instrument.

The interior of this instrument should not be inspected by anyone other than service technicians who are trained to avoid hazards.

2.2 Installation

2.2.1 General cautions

⚠ CAUTION

Attention should be given to the following items to reduce the possibility of damage to this instrument.

- The instrument has a fan for forced-air cooling. If you notice that the fan is not moving, immediately disconnect the instrument from the power source and contact the NF Corporation or its authorized agent. Continued use of the instrument while the fan is stopped may increase damage to the instrument and make repair difficult.
 - The instrument has air intake and exhaust vents on the sides, rear, and bottom. Do not cover the air vents.
 - Do not use this instrument while it is positioned such that it is resting on a surface with a side or the rear facing down. Doing so creates the risk of the instrument tipping over. The instrument must be placed on a level surface such as a desk with the bottom side facing down and with all four feet attached when in use.
-

2.2.2 Installation environment

- Place this instrument in a location that satisfies the following conditions.
 - Operation: +5 to +40°C, 5 to 85 %RH (absolute humidity 1 to 25 g/m³, no condensation)
 - Storage: -10 to + 50°C, 5 to 95 %RH (absolute humidity 1 to 29 g/m³, no condensation)
- Place the instrument in a location of altitude 2000 m or less.
- Avoid using the instrument in environments where there is strong radio-frequency electromagnetic radiation. Using the instrument in such environments may result in temporary fluctuations in measurement results.

⚠ CAUTION

Avoid installation in the following locations.

- Where there is flammable gas
There is a risk of explosion. Never install or use it in such a location.
 - Outdoors, where exposed to direct sunlight, or near fire or a heat source
The performance may not be satisfied, or a failure may occur.
 - Where there are corrosive gases and vapors, a lot of dust and particles, salty air and oily smoke, and metal powder, etc.
 - Where there is a lot of vibration
Malfunction or a failure may occur.
 - Near an electromagnetic field source, high-voltage equipment, power line, or pulse noise source
Malfunction or a failure may occur.
-

Signal cables should be placed away from the power cords and other components of this instrument and

other equipment that may produce inductive noise. Failure to do so may result in instrument malfunction or measurement error.

To ensure accurate measurement, calibrate the instrument after a warm-up period of at least 30 minutes before use.

2.2.3 Rack mounting

This instrument can be installed in a 19-inch IEC rack or EIA standard rack, or a JIS standard rack by using the appropriate optional rack mounting kit. Rack mounting kits are available for millimeter racks (JIS) and inch-racks (EIA).

First, assemble the rack mounting kit as shown in "Figure 2-1 Rack mounting assembly diagram (JIS)" or "Figure 2-2 Rack mounting assembly diagram (EIA)" and then install the instrument in the rack.

WARNING

When mounting unit in the rack, be sure to use a rack rail or other means and support the instrument while working. Failure to do so, may result in injury to yourself or damage to the instrument from falling.

CAUTION

- Make sure that there are sufficient air vents in the rack or that a cooling fan is installed.
- The instrument has air vents on both sides and in the rear.

Make sure that there is at least 20 mm of distance between the sides of the instrument and the inner walls of the rack.

- There is an air exhaust vent on the rear panel.

Make sure that there is at least 50 mm between the rear of the instrument and the inner wall of the rack.

If the ambient temperature exceeds the specification or if the air exhaust vent is blocked, the performance of the instrument may decrease or the instrument may be damaged.

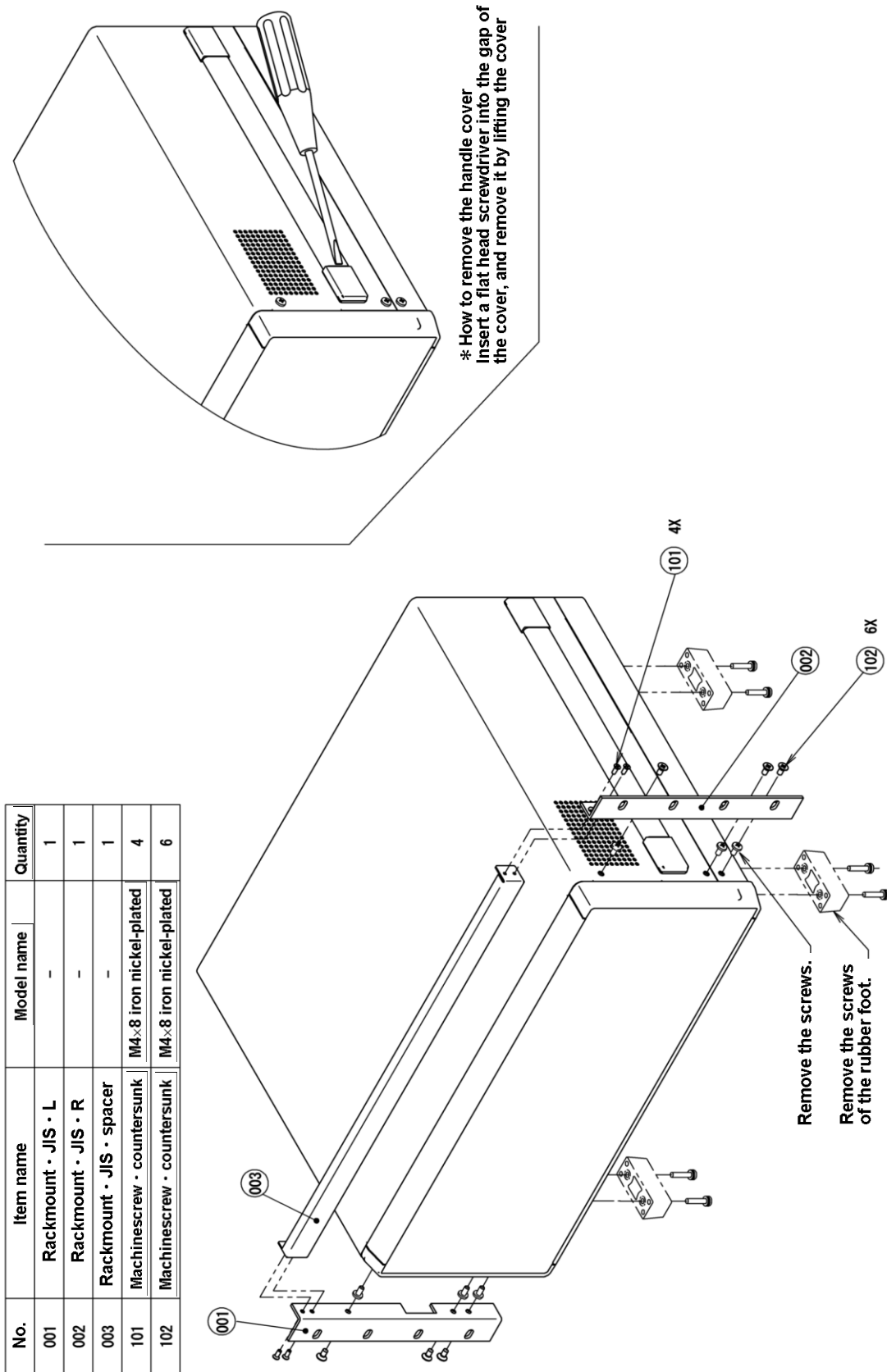

Figure 2-1 Rack mounting kit assembly diagram (JIS)

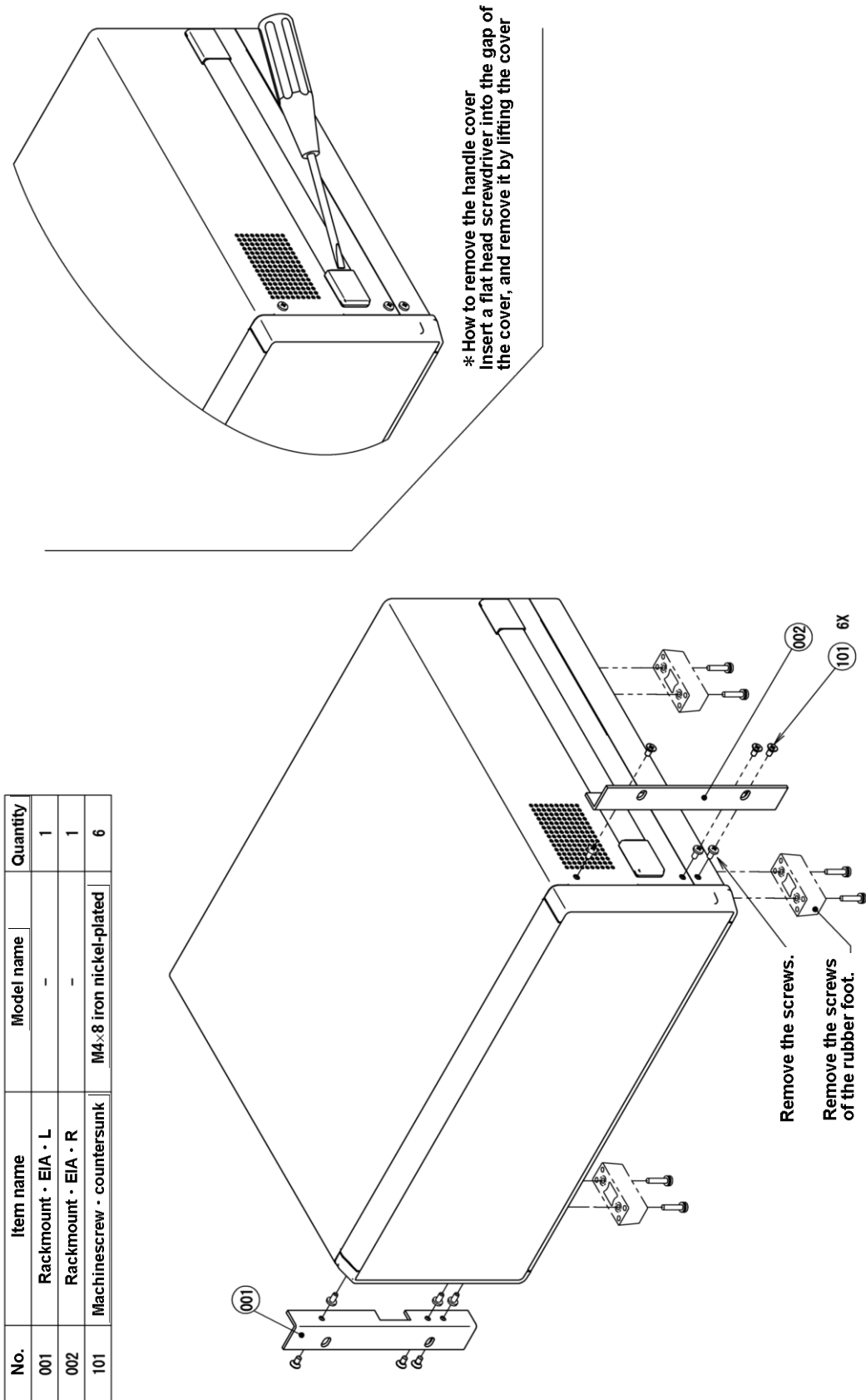

Figure 2-2 Rack mounting kit assembly diagram (EIA)

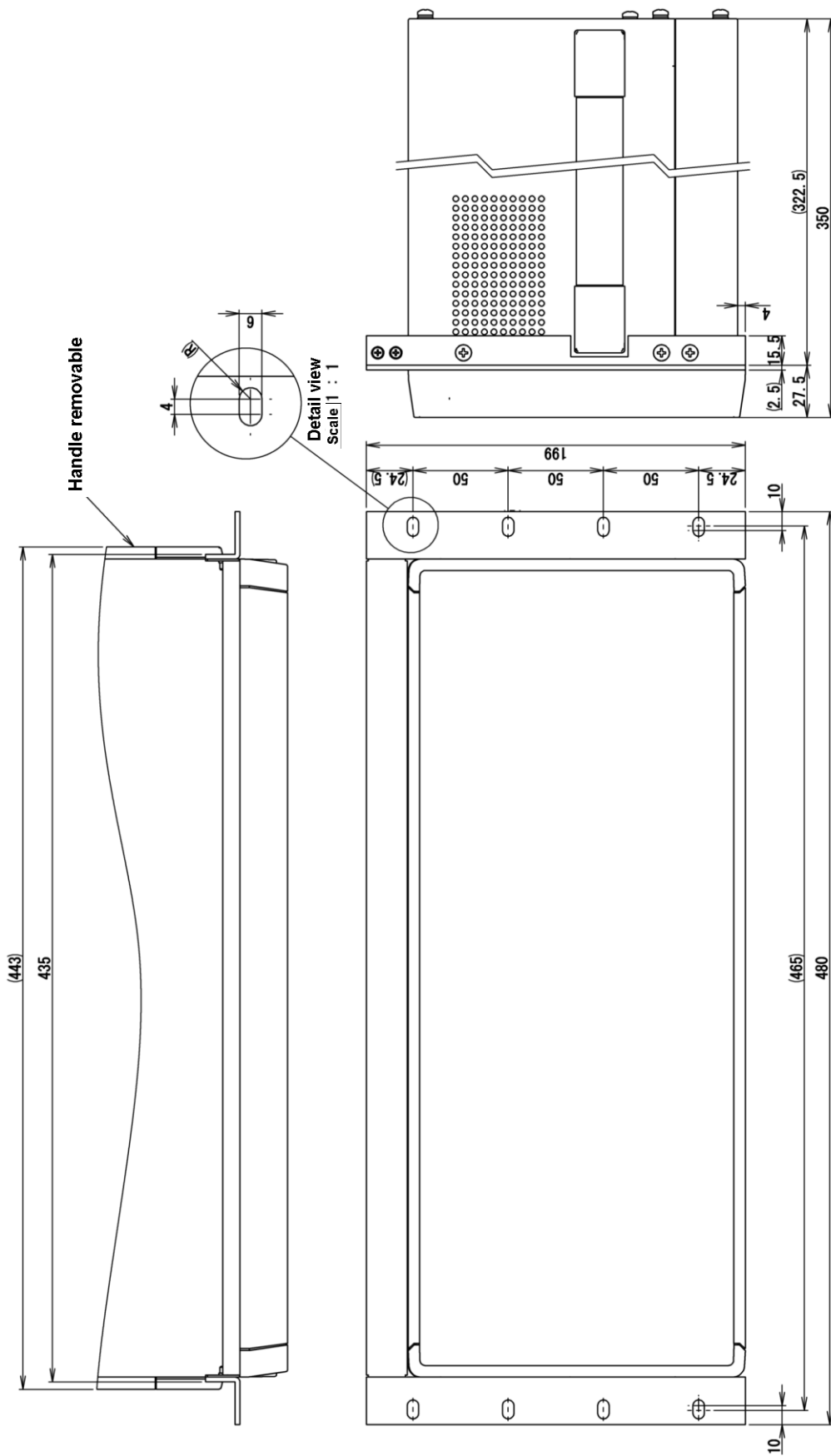

Figure 2-3 Rack mounting kit dimensions (JIS)

Caution

- When storing in a rack, do not hold with rack mount adapter alone. Be sure to provide L bracket or shelf on the rack side and hold the main unit.
- When the opening of the rack is narrow, remove the side handle.

Surface treatment

Rack mount adapter : Ultralight-gray coating (Munsell 6PB9.2/0.1)

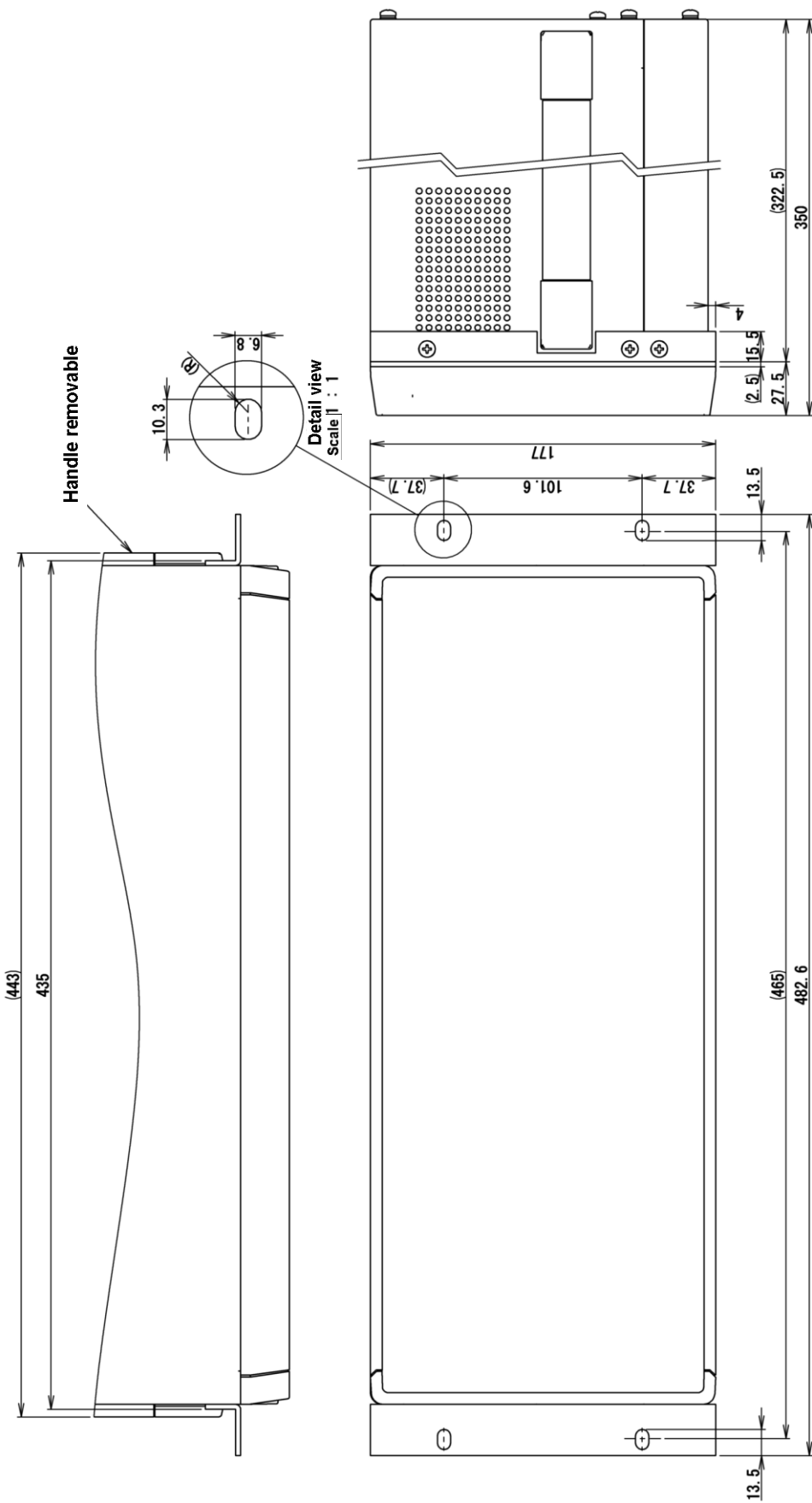

Figure 2-4 Rack mounting kit dimensions (EIA)

Surface treatment
 Rack mount adapter : Ultralight-gray coating (Munsell 6PB9.2/0.1)

- Caution**
- When storing in a rack, do not hold with rack mount adapter alone. Be sure to provide L bracket or shelf on the rack side and hold the main unit.
 - When the opening of the rack is narrow, remove the side handle.

2.3 Grounding and power connections

- The instrument must be grounded.

⚠ WARNING

This instrument uses line filters and there is risk of electrical shock if the instrument is not grounded.

To prevent electrical shock, connect it to an earth ground so that ground resistance is 100 Ω or less.

This instrument is automatically grounded when the provided power cord with a three-terminal plug is inserted into three-terminal ground-protected outlet.

- Power supply specifications

Power supply voltage range	: 100 VAC to 230 VAC \pm 10%, not to exceed 250 V
Frequency	: 50 Hz / 60 Hz \pm 2Hz
Power consumption	: 100 VA, maximum
Overvoltage category	: II

- Connecting the power supply

- 1) Confirm that the voltage of the mains to which the instrument is connected is within the specified voltage range of the instrument.
- 2) Set the power switch that is on the rear panel to the off position.
- 3) Insert the power cord into the power inlet that is on the rear panel of the instrument.
- 4) Plug the power cord into a ground-protected power outlet.
- 5) Set the power switch to the on position and keep the power switch on during normal operation of the instrument.

⚠ CAUTION

The power cord set that comes with the instrument is intended for use only with this instrument.

The power cord set should not be used with any other product or for any other purpose.

When connecting the instrument to the mains, be sure to use only the power cord that is provided with the instrument.

If the power to the instrument is turned off, wait at least one minute before turning it back on again.

- In an emergency, the power cord can be used to disconnect the instrument from the mains.

 **WARNING**

Confirm that there is sufficient space around the power inlet of the instrument to ensure that the power cord can be removed easily. Alternatively, plug the power cord into a power outlet that is easily accessible and has sufficient space around it to allow easy removal of the power plug.

If smoke or an unusual odor or sound is emitted from the instrument, immediately unplug the power cord and do not use the instrument again until it has been repaired.

2.4 Quick operation check

If the instrument has not been used for a long time after purchase, you should check instrument operation by the procedure described below. Prepare the two calibration cables and the BNC adapter that are supplied with the instrument.

For a description of the labels and operation of the keys and screen displays, etc., please refer to "3.1 Function and use of each part of the panels" and "3.3 Operation screens".

1. After connecting the instrument to the power supply, press the standby switch on the front panel and then wait until the system check ends normally.

About the appearance of the display after the power has been turned on

→ "4.1 Display and operation for powering up".

2. Initialize the settings.

Press the **MENU** key two times and then tap on [Other] on the second page of the top menu. Select **【Other】** - [RESET] and then press the **ENTER** key. When the confirmation message is displayed, tap on the [YES] button.

3. Plug the provided BNC adapter into the OUTPUT OSC connector. Plug the provided calibration cables (20 cm) into the BNC adapter and connect them to INPUT CH1 and INPUT CH2 as shown in the following diagram.

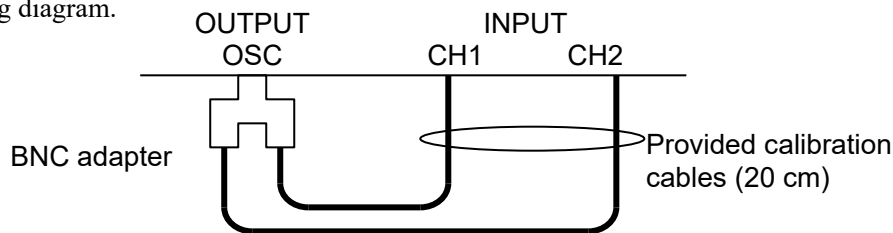

4. Run the calibration (self-measurement for error correction).

Tap on [Calib.] on the second page of the top menu. Select **【Calibration】** - [CALIBRATION] and then press the **ENTER** key. When the cable connection confirmation message is displayed, tap on the [OK] button and then wait until the calibration is completed.

For information on calibration → "5.9.1 Calibration".

5. Turn the oscillator output on.

On the front panel, press the ON **AC/DC** key to turn on the oscillator output.

The AC lamp and DC lamp to the right of the ON **AC/DC** key both light up.

6. Perform a sweep measurement to confirm that correct measurement is possible.

On the front panel, press the MEASURE START **UP** key to perform an up-sweep measurement.

When the measurement is finished, a graph display of the gain and phase is presented. The normal values are 0 dB \pm 0.05 dB for the gain and 0 deg \pm 3.0 deg for the phase.

This concludes the simple operation check.

2.5 Calibration

The instrument performance test described in "8.5 Performance test" should be performed. Although the testing interval depends on how often the instrument is used and the conditions under which it is used, the test should be performed at least once a year. When the instrument is used for important measurements or tests, it is recommended that the performance test be performed immediately before use.

If the instrument fails to satisfy the specifications in the performance test, the NF Corporation will make adjustments or calibrate the instrument to restore performance. If calibration or adjustment is necessary, please contact the NF Corporation or its authorized agent. Please understand that there is a charge for calibration and adjustment.

3. Panel operations

3.1	Function and use of each part of the panels	3-2
3.1.1	Front panel	3-2
3.1.2	Rear panel	3-3
3.1.3	Display screen and keys	3-4
3.1.4	Front panel keys	3-5
3.2	Input and output connectors	3-9
3.3	Outline of operation screen	3-20
3.3.1	Menu operation	3-20
3.3.2	Outline of graph display	3-32
3.4	Operation tree	3-33
3.5	Operation screen reference	3-39
3.5.1	OSC dialog	3-40
3.5.2	Measure dialog	3-48
3.5.3	Sweep dialog	3-51
3.5.4	Graph dialog	3-55
3.5.5	Marker dialog	3-62
3.5.6	Trace dialog	3-68
3.5.7	Input dialog	3-70
3.5.8	Storage dialog	3-73
3.5.9	Remote dialog	3-79
3.5.10	Calibration dialog	3-82
3.5.11	Other dialogs	3-86
3.5.12	BASIC SETUP dialog	3-87
3.6	Initial settings	3-88

3.1 Function and use of each part of the panels

The names and functions of each part of the front panel and rear panel and how each is used are described in the section.

3.1.1 Front panel

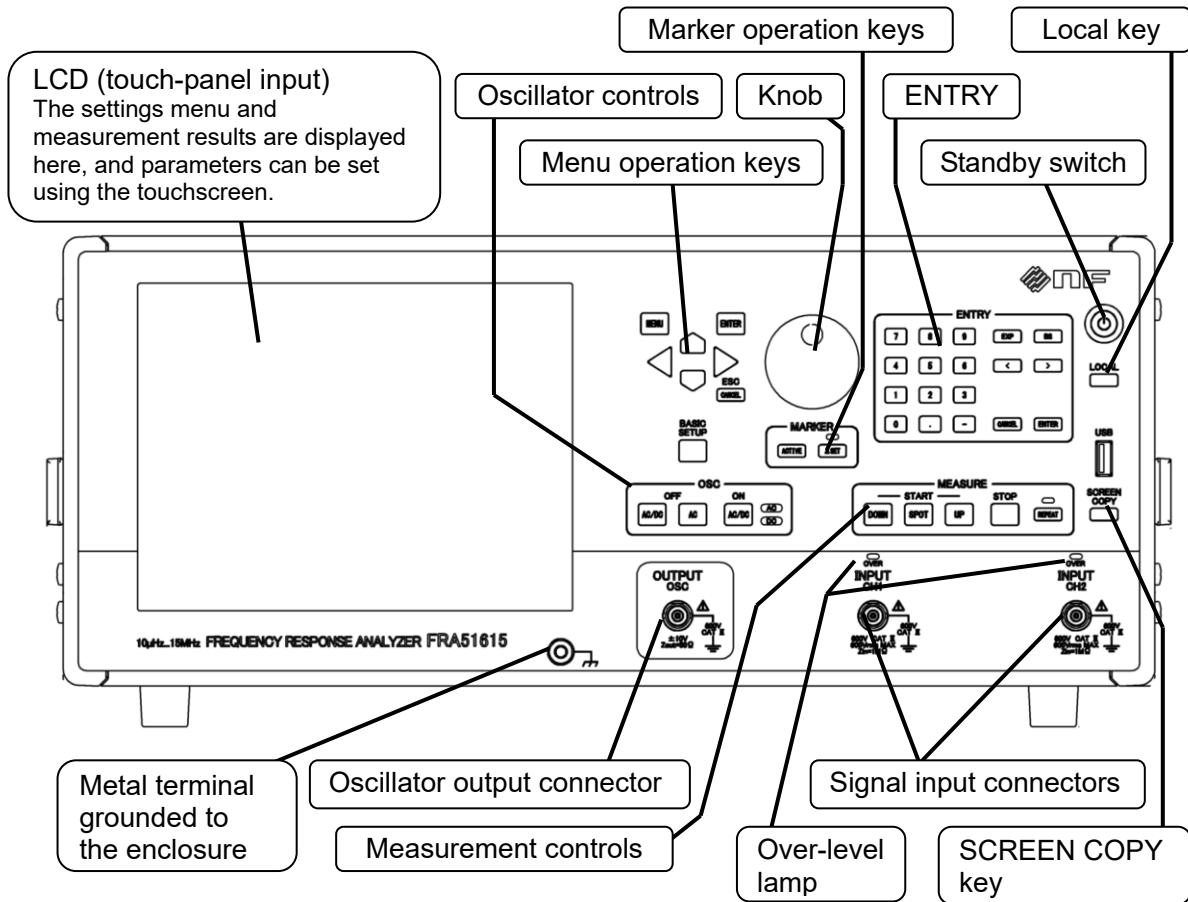

Figure 3-1 Front panel

3.1.2 Rear panel

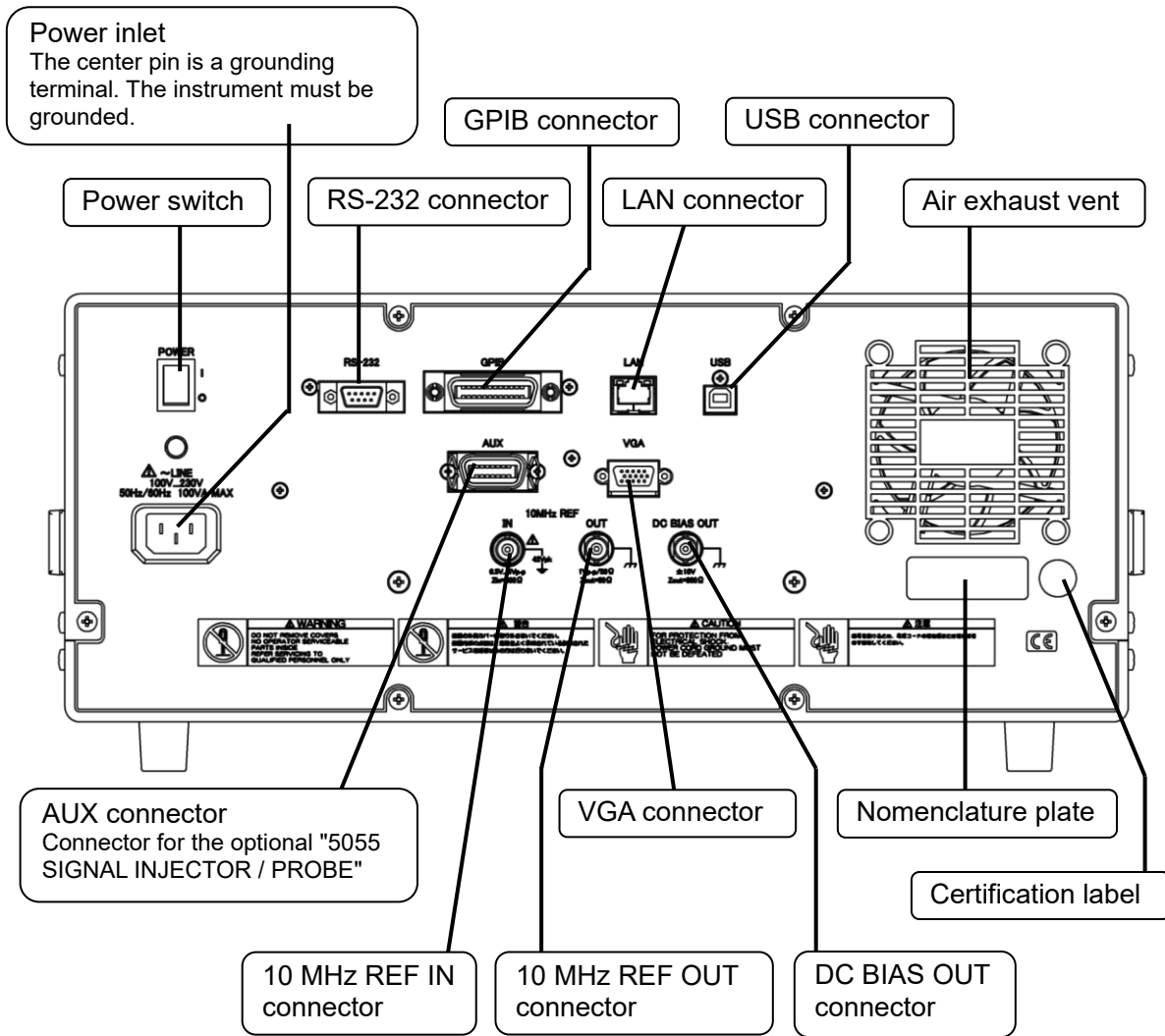

Figure 3-2 Rear panel

3.1.3 Display screen and keys

This instrument is operated by using the keys and LCD touch screen on the front panel. Some operations can be performed either way. All of the input devices are always available for use, so they can be used together to complete single operations. For example when entering numerical values, it is possible to use the LCD touch screen to enter the first digits of the number and then complete the entry by using the keys on the front panel.

This instrument uses a graphical user interface (GUI). Settings and operations can be performed by opening menus and tapping on the functions that are displayed on the screen. Functions can also be invoked by tapping on the LCD screen button controls.

[Hardware Key Title]

Indicates a key with this name or symbol printed on the key top. Keys that do not have printed labels are identified by the name that appears directly above them on the panel.

A cursor key indicates the direction by its shape and the title is not printed on it.

[Hardware Key Title] / Secondary Function Name

Indicates a key that has secondary function printed around the key, in addition to the main function printed on the key top. In this manual, the notation "/secondary function name" is appended to a description to indicate that the secondary function is to be executed. When the main function is to be executed, the notation "/secondary function name" is not appended.

[Lamp Title]

Indicate the name of the nearest key or the lamp that displays a title when it is lit.

【Dialog Title】

Indicates the GUI dialog box (window) that is displayed on the LCD screen.

[Button Title]

Indicates GUI button that is displayed on the LCD screen. Input is performed by tapping the button on the screen.

3.1.4 Front panel keys

- Menu operation keys and knob

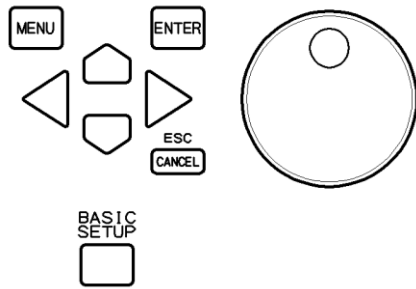

- **MENU** : This displays the top menu on the LCD. The top menu has two pages. Each time the key is pressed moves to the next display in the continuous sequence of Page 1/2 → Page 2/2 → (top menu clear) → Page 1/2 →... . For more information, refer to "■ Top menu" in "3.3.1 Menu operation".
- **ENTER** : If pressed when a menu item is selected, the selected item is put into the editing state. If pressed while in the editing state, the editing result is set.
- **CANCEL** / **ESC** : If pressed, the editing operation (changing of the setting) is canceled and the setting is returned to the value before editing.
- **Up/down/left/right keys** : The left and right keys are used for navigating hierarchical menus or for moving the cursor between numerical values or between characters in a text string during editing. The up and down keys are used for moving between menus and increasing or decreasing numerical or text values during editing.
- **BASIC SETUP** : If pressed, a shortcut menu is displayed for quick access to items that are frequently changed.
- **Knob** : This is turned to move between menus or to increase or decrease the values of numbers or text during editing. It is also used for moving markers when markers are displayed on a measured value graph.

- Marker operation keys

The two types of markers used for reading data trace values displayed on a graph are main markers and delta markers. Each type of marker can be set to display or hide by using [MARKER] on the **【Marker】** dialog box.

The two types of data traces referred to by markers are measurement data (MEAS DATA TRACE) and reference data (REF DATA TRACE). Data traces can be displayed or hidden by using the [DISPLAY TRACE] on the **【Graph】** dialog.

You can switch the selection between the currently displayed markers and the data trace indicated by the markers by using the keys shown below. Markers and data traces that are not being displayed cannot be selected.



- ACTIVE** : If pressed, the data trace that is indicated by the markers is switched.

When the **ΔSET** lamp is not lit, each time this button is pressed, the data trace indicated by the main marker is toggled between the measurement data trace and the reference data trace.

When the **ΔSET** lamp is lit, each time this button is pressed, the data trace indicated by the delta marker is toggled between the measurement data trace and the reference data trace.
- ΔSET** : If pressed, the marker that is operative is switched. Each time the button is pressed toggles the **ΔSET** lamp on and off.

If the knob is turned while the **ΔSET** lamp is not lit, the main marker and the delta marker move together on the x axis, maintaining a constant distance between them.

If the knob is turned while the **ΔSET** lamp is lit, the delta marker moves, but the position of the main marker does not change.

The reading value of the marker depends on whether or not the **ΔSET** lamp is lit.

ΔSET lamp is not lit : The main marker value is displayed.

ΔSET lamp is lit : The difference between the main marker in the delta marker is displayed.

- SCREEN COPY** key



- SCREEN COPY**: This outputs an image of the current LCD screen.

If a USB memory device has been inserted into the USB port of the front panel, image data for the current screen is output to the USB device as a file in bitmap format (.bmp). If the specified printer is connected, the screen image is printed. For information on the printer, refer to section "5.14.7 Printer".

• Measurement controls

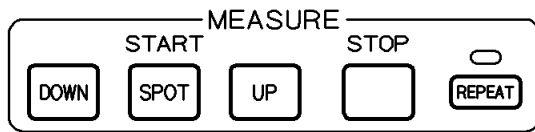

- **DOWN** **UP** : Pressing either of these buttons begins a sweep measurement. **DOWN** indicates that the sweep direction is from the upper limit of the sweep frequency to the lower limit; **UP** indicates that the sweep direction is from the lower limit to the upper limit.
- **SPOT** : Pressing this button begins a spot measurement at the frequency that is currently set.
- **STOP** : Pressing this button stops a sweep or spot measurement.
- **REPEAT** : Pressing this button toggles the **REPEAT** lamp that is above the key on and off.
If a sweep or spot measurement is started while the **REPEAT** lamp is lit, the measurement is repeated. Spot measurements are repeated at the same frequency and sweep measurements are repeated by repeating the sweep after the sweep ends. Pressing the **STOP** key ends the measurements.
If a spot measurement is begun while the **REPEAT** lamp is not lit, the measurement is performed one time at the current frequency. If a sweep measurement is begun, the sweep is made one time.

• Oscillator controls

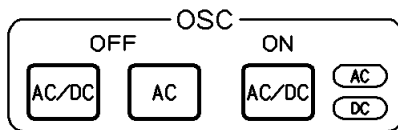

- **AC/DC OFF** : Turns the output voltages off. Neither the **AC** lamp or the **DC** lamp is lit.
- **AC OFF** : Turns only the AC output voltage off. Only the **AC** lamp is not lit.
- **AC/DC ON** : Turns the output voltages on. Both the **AC** lamp and the **DC** lamp are lit.
When the setting is changed, the actual output voltages do not change until this key is pressed, even if the **AC** lamp and **DC** lamp are lit.

• Local key



Pressing this key changes the panel control mode from remote state to local state. However, if remote with lockout state is in effect (GPIB and USBTMC only), this key is disabled.

- ENTRY (keypad)

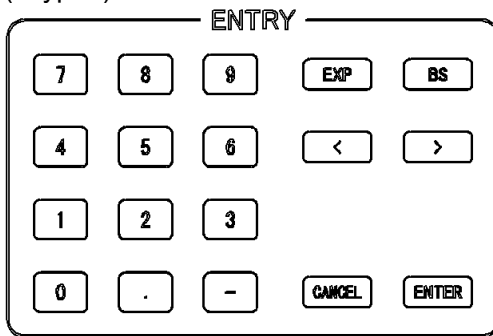

This is a set of keys for entering parameter settings.

- 0 to 9, ., - : These are used to input numerical values
- EXP : These are used to input numerical values in exponent format.
- BS : Backspace key
Pressing this key when entering values deletes the numerical character that is to the left of the cursor. After deletion, the string of characters that is to the right of the cursor shifts one character to the left.
- < > : Keys for moving the cursor position to the left or right
- ENTER : Pressing this key after entering the numerical value sets that value. The current setting is maintained until this key is pressed.
- CANCEL : Pressing this key cancels the input that is in progress and returns the setting to the previous value.

- LCD touch panel

The LCD panel of this instrument is equipped with a touch panel. You can select and set instrument functions and measurement parameters by touching the screen. The touch panel uses a resistive film, so you can use a nonconductive stylus pen or a gloved finger tip to operate it.

The surface of the touch panel is easily scratched, so do not use hard or sharp objects to operate it.

3.2 Input and output connectors

■ Analyzer input connectors (CH1 and CH2)

The input and output channels of the instrument analysis module (CH1 and CH2) are each electrically isolated from the instrument enclosure. The oscillator output (OSC) is also isolated.

Maximum input voltage : 600 V CAT II or 300 V CAT III (BNC signal to BNC ground)

Input impedance : 1 M Ω \pm 2%, 20 pF \pm 5 pF in parallel

Isolation voltage : 600 V CAT II or 300 V CAT III (BNC ground to enclosure)

Connector : Front panel, insulated BNC connector

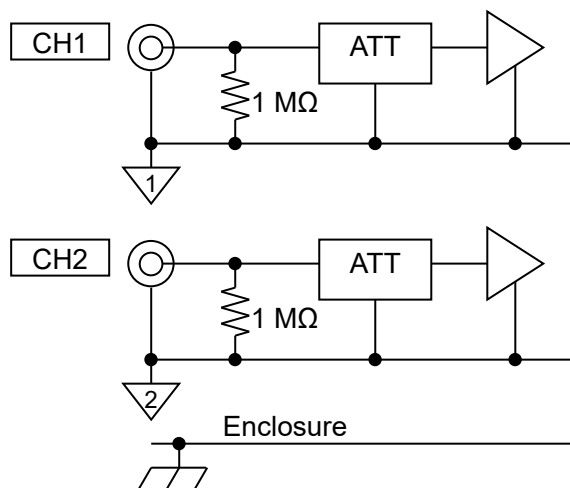

The isolation of the input connectors and the enclosure is maintained even when the power is turned off.

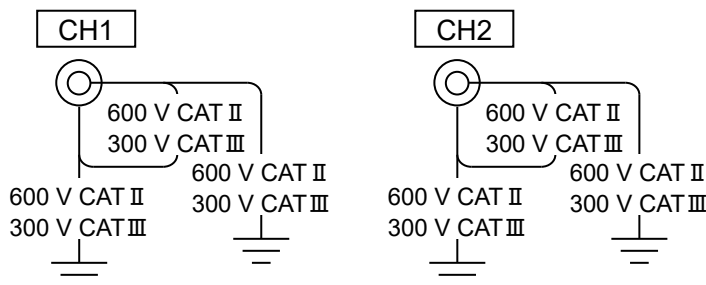

Figure 3-3 Isolation rating of the analyzer input connectors

⚠ WARNING

Do not connect this instrument to circuits that exceed MEASUREMENT CATEGORY II/600 V or MEASUREMENT CATEGORY III/300 V. Doing so may result in insulation breakdown and risk of electrical shock. This instrument may also be damaged by connection to circuits that exceed the specifications.

Using a BNC connector that has exposed metal parts rather than the insulated BNC cable that is provided with this instrument may expose the user to high voltages and the risk of electrical shock. The coaxial BNC cable that is provided with this instrument is designed for safety. When dealing with dangerously high voltages that exceed 30 Vrms or 42Vpk, be certain to use the provided cable.

The maximum isolation voltage is restricted according to the frequency as described below. Applying high voltages at high frequencies may result in a large AC current flowing in floating capacitance within the instrument, creating a risk of damage to the equipment. Be certain to use the instrument at voltages below the rated isolation voltage.

o Maximum isolation voltage by frequency

- Below 45 Hz : 600 Vpk (AC + DC)
- 45 Hz to 100 kHz : 600 Vrms
- 100 kHz to 3 MHz : $600 \text{ Vrms (AC)} \times 100 \div F$, where F is frequency in kHz
- 3 MHz to 15 MHz : 20 Vrms (AC)

For frequencies of 45 Hz or higher, the RMS voltage including DC is 600 Vrms or less and the peak voltage is 849 Vpk or less.

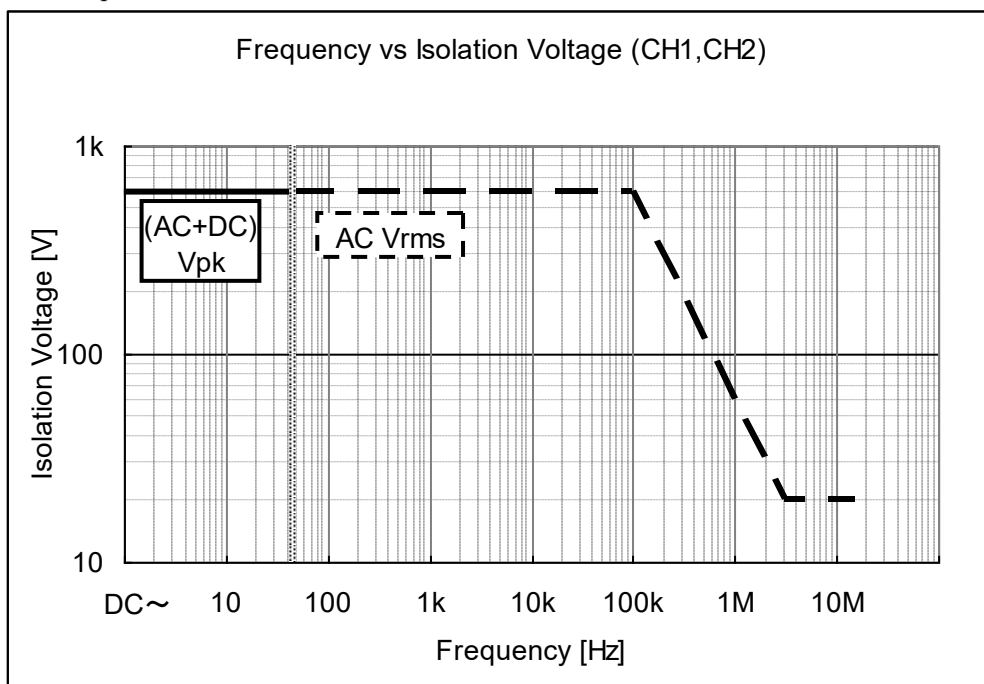

Figure 3-4 Isolation withstand voltage of the analysis module input connectors by frequency

This rating is for when there is no transient overvoltage. For measurements in mains circuits where transient overvoltages can occur, use the MEASUREMENT CATEGORY specifications described previously.

⚠ WARNING

Do not apply voltages that exceed the rated isolation voltage. Doing so may result in insulation breakdown and risk of electrical shock. Damage to the instrument may also result.

The maximum input voltage is restricted according to the frequency as described below. Applying high voltages at high frequencies may result in a large AC current flowing in floating capacitance within the instrument, creating a risk of damage to the equipment. Be certain to use the instrument at voltages below the rated isolation voltage.

○ Maximum input voltage by frequency

Below 45 Hz	: 600 V _{pk} (AC+DC)
45 Hz to 100 kHz	: 600 V _{rms}
100 kHz to 3 MHz	: $600 \text{ V}_{\text{rms}} (\text{AC}) \times 100 \div F$, where F is frequency in kHz
3 MHz to 15 MHz	: 20 V _{rms} (AC)

For frequencies of 45 Hz or higher, the RMS voltage including DC is 600 V_{rms} or less and the peak voltage is 849 V_{pk} or less.

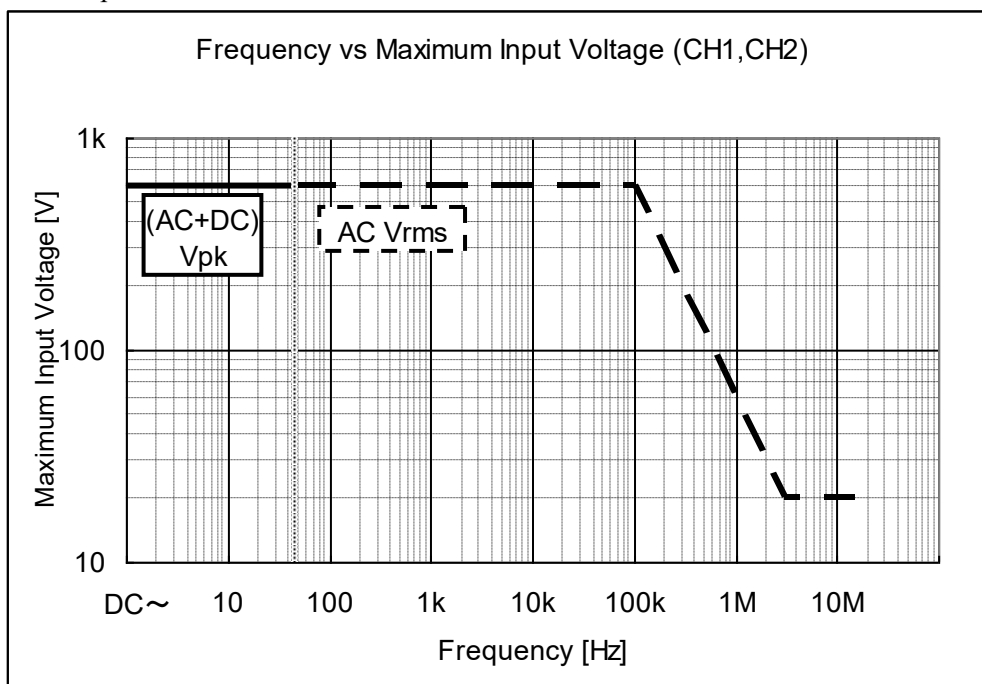

Figure 3-5 Maximum input voltage of the analysis module input connectors by frequency

This rating is for when there is no transient overvoltage. For measurements in commercial mains circuits where entrancing over voltages can occur, use the MEASUREMENT CATEGORY specifications described previously.

WARNING

Do not apply voltages that exceed the rated isolation voltage. Doing so may result in insulation breakdown and risk of electrical shock. Damage to the instrument may also result.

■ Oscillator output connector (OSC)

The oscillator output (OSC) is electrically isolated from the instrument enclosure. The analyzer inputs (CH1 and CH2) are also both isolated.

Maximum output voltage : ± 10 V (AC + DC)

Maximum output current : ± 100 mA

Output impedance: : $50 \Omega \pm 2\%$

Isolation voltage : 600 V CAT II or 300 V CAT III (BNC ground to enclosure)

Connectors : Front panel, insulated BNC connector

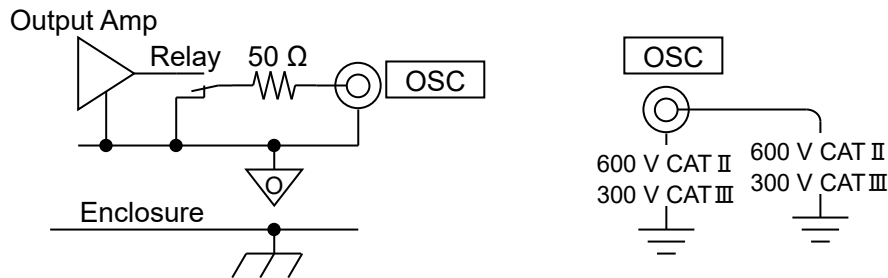

Figure 3-6 Isolation rating of the oscillator output connector

WARNING

Do not connect the instrument to circuits that exceed MEASUREMENT CATEGORY II/600 V or MEASUREMENT CATEGORY III/300 V. Doing so may result in insulation breakdown and risk of electrical shock or damage to the equipment.

Using a BNC connector that has exposed metal parts rather than the insulated BNC cable that is provided with this instrument may expose the user to high voltages and the risk of electrical shock. The coaxial BNC cable that is provided with this instrument is designed for safety. When dealing with dangerously high voltages that exceed 30 Vrms or 42Vpk, be certain to use the provided cable.

The AC signal is output from the OSC connector on the front panel. The DC bias is output from either the front panel OSC connector or the rear panel DC BIAS OUTPUT connector (simultaneous output from both connectors is not possible). The connector for output of the DC bias can be selected from the menu.

About the DC bias setting → "4.3 Oscillator settings".

The output impedance is 50 ohms, regardless of whether the output is on or off. Even when the output is set to off, the relay is constantly connected to the internal output amplifier (the relay is always on). For that reason, turning the output on or off does not affect the output impedance.

When the power supply is off, the relay is also off and the output amplifier is disconnected from the OSC connector. Even in that state, the output impedance is remains at 50 ohms. However, when the power is turned on or turned off, the output impedance is temporarily unstable.

The output voltage is set at a time of no load (open load). When a 50 ohm load is connected, the output is at half of the set voltage. The maximum output current is 100 mA. This instrument can be connected to a load resistance of 50 ohms or more at maximum output.

The maximum isolation voltage is restricted according to the frequency as described below. Applying high voltages at high frequencies may result in a large AC current flowing in floating capacitance within the instrument, creating a risk of damage to the equipment. Be certain to use the instrument at voltages below the rated isolation voltage.

○ Maximum isolation voltage by frequency

- Below 45 Hz : 600 Vpk (AC + DC)
- 45 Hz to 100 kHz : 600 Vrms
- 100 kHz to 3 MHz : $600 \text{ Vrms (AC)} \times 100 \div F$, where F is frequency in kHz
- 3 MHz to 15 MHz : 20 Vrms (AC)

For frequencies of 45 Hz or higher, the RMS voltage including DC is 600 Vrms or less and the peak voltage is 849 Vpk or less.

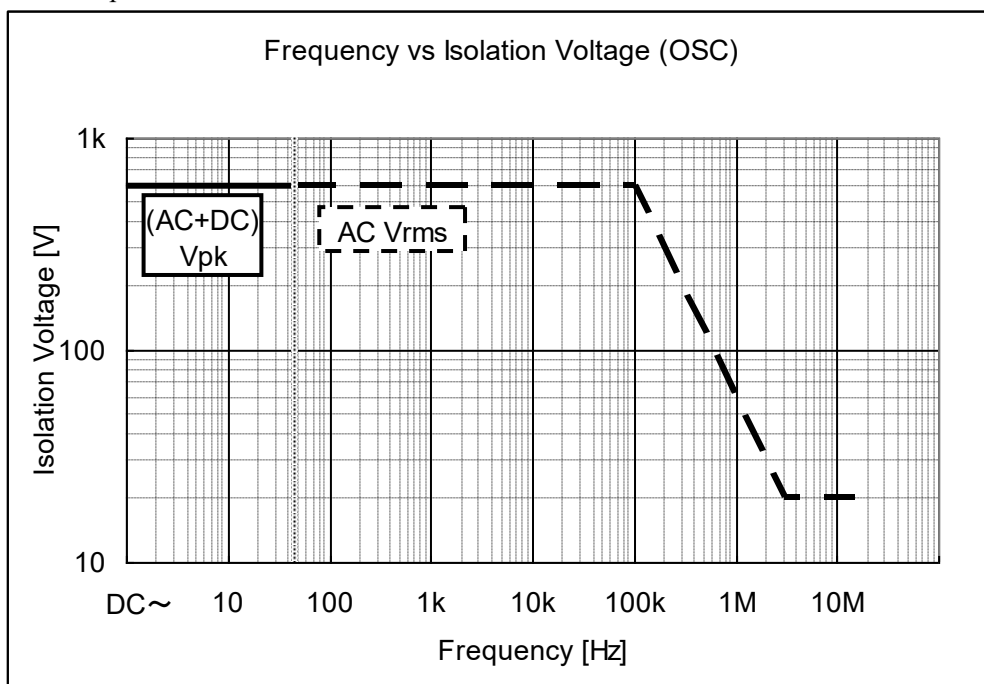

Figure 3-7 Isolation withstand voltage of the oscillator output connector by frequency

This rating is for when there is no transient overvoltage. For measurements in mains circuits where transient overvoltages can occur, use the MEASUREMENT CATEGORY specifications described previously.

⚠ WARNING

Do not apply voltages that exceed the rated isolation voltage. Doing so may result in insulation breakdown and risk of electrical shock. Damage to the instrument may also result.

⚠ CAUTION

Applying an external signal to the OSC output connector will damage the internal circuits. Never input a signal to the OSC output connector.

■ Ratings for isolation between CH1, CH2, and OSC

The analyzer input connectors (CH1 and CH2) and the oscillator output connector (OSC) are all mutually isolated.

Isolation voltage : 600 V CAT II or 300 V CAT III (between CH1, CH2, and OSC, to BNC ground)

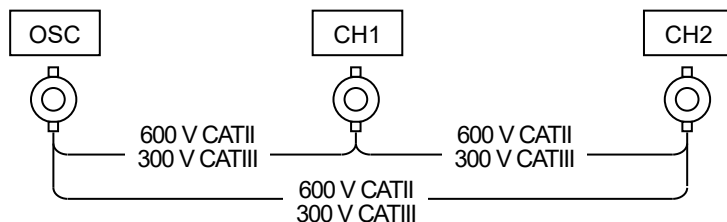

Figure 3-8 Isolation withstand voltage between signal connectors

The maximum isolation voltage is restricted according to the frequency as described below. Applying high voltages at high frequencies may result in a large AC current flowing in floating capacitance within the instrument, creating a risk of damage to the equipment. Be certain to use the instrument at voltages below the rated isolation voltage.

○ Maximum isolation voltage by frequency

Below 45 Hz	: 600 V _{pk} (AC+DC)
45 Hz to 100 kHz	: 600 V _{rms}
100 kHz to 3 MHz	: 600 V _{rms} (AC) × 100 ÷ F, where F is frequency in kHz
3 MHz to 15 MHz	: 20 V _{rms} (AC)

For frequencies of 45 Hz or higher, the RMS voltage including DC is 600 V_{rms} or less and the peak voltage is 849 V_{pk} or less.

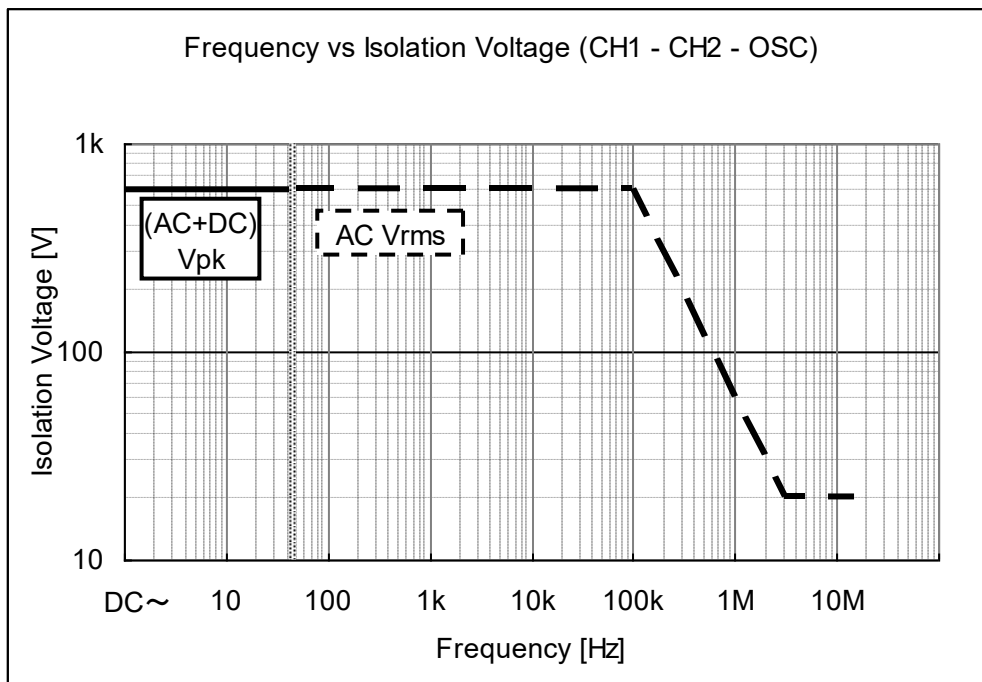

Figure 3-9 Isolation withstand voltage between the signal connectors by frequency

This rating is for when there is no transient overvoltage. For measurements in mains circuits where transient overvoltages can occur, use the MEASUREMENT CATEGORY specifications described previously.

⚠ WARNING

Do not apply voltages that exceed the rated isolation voltage. Doing so may result in insulation breakdown and risk of electrical shock. Damage to the instrument may also result.

■ AUX

This is a special connector for supplying power to the "5055 SIGNAL INJECTOR / PROBE " (optional) when using the probe for servo loop measurements. Use the cable that is provided with the probe to connect the probe to this instrument. Do not use the cable for connecting any device other than the 5055.

Concerning use of the 5055 → the 5055 manual.

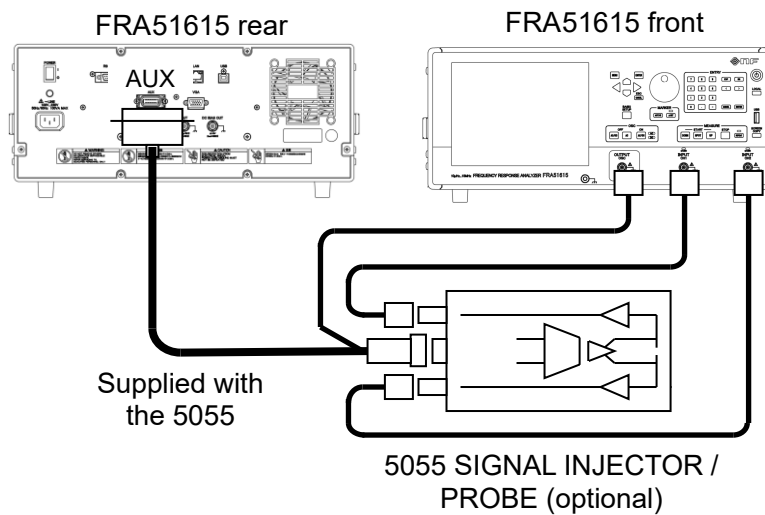

It is possible to do servo loop measurements (loop characteristic measurements) even without the 5055, using this instrument alone. The isolation withstand voltage with this instrument is 600 V, but it is restricted to 10 V when the instrument is used together with the 5055. The advantage of using the 5055 is that it has little effect on measured circuits where the floating capacitance is extremely small. For more information, refer to the manual for the 5055.

■ VGA

This connector outputs a video signal that is the same as the instrument LCD to an external monitor or projector.

Connector : 15-pin mini-D-sub (female), analog RGB component video signal

Signal : 800 × 600 pixel (SVGA)

Horizontal frequency = 37.9 kHz; vertical frequency = 60.3 Hz

■ DC BIAS OUT

This is an output connector for supplying DC bias to the equipment under test.

Maximum output voltage : ±10 V

Output impedance : 600 Ω ±2%

Connector : Rear panel, BNC connector

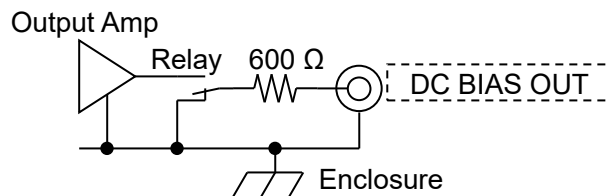

If the connector to which the DC bias voltage is output is set to the rear-panel DC BIAS OUT connector, the DC bias (DC voltage) is output from this connector. In that case, only the AC component is output from the OSC connector on the front panel.

About the setting of the DC bias → "4.3 Oscillator settings".

The output impedance is 600 ohms, regardless of whether the output is on or off. Even when the output is set to off, the relay is constantly connected to the internal output amplifier (the relay is always on). For that reason, turning the output on or off does not affect the output impedance.

When the power supply is off, the relay is also off and the output amplifier is disconnected from the rear-panel DC BIAS OUT connector. Even in that state, the output impedance remains at 600 ohms. However, when the power is turned on or turned off, the output impedance is temporarily unstable.

The output voltage is set when there is no load (open load). When a 600 ohm load is connected, the output is at half of the set voltage.

⚠ CAUTION

- Applying an external signal to the DC BIAS OUT connector will damage the internal circuits. Never input a signal to the DC BIAS OUT connector.
- The BNC ground of the DC BIAS OUT connector is connected to the enclosure. Do not connect signals for which there is a difference in potential relative to the enclosure. Doing so may damage the instrument.

■ 10 MHz REF IN

If a clock signal is input to this connector, that replaces the internal reference clock of the instrument and the instrument will operate on the external clock. The accuracy of the measurement frequency is determined by the accuracy of the clock frequency that is input. Frequency-synchronized measurement across multiple devices is possible by using a common reference clock.

Input voltage	: 0.5 V _{p-p} to 5 V _{p-p}
Input waveform	: Sinusoidal or square
Input impedance	: 300 Ω (nominal), AC coupling
Maximum non- destructive voltage	: 10 V _{p-p}
Signal ground	: Isolated from enclosure, ±42 V (DC + AC _{pk}) max.
Connector	: Rear panel, BNC connector

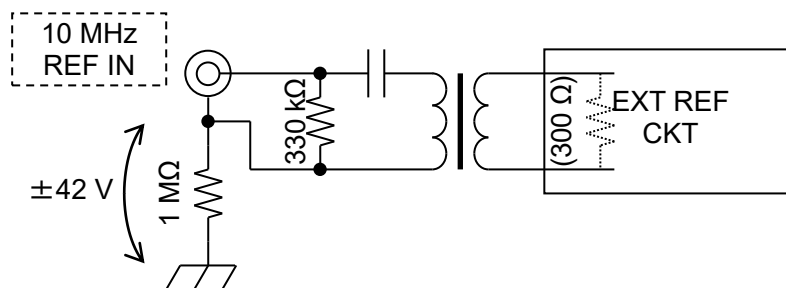

⚠ WARNING

Do not apply voltages that exceed the rated isolation voltage. Doing so may result in insulation breakdown and risk of electrical shock or damage to the instrument.

■ 10 MHz REF OUT

This connector outputs the clock signal that is actually used as the reference clock by the instrument. When the instrument is operating on an external 10 MHz reference clock (input to 10 MHz REF IN), the frequency that is output is the same as the frequency of the external reference clock.

Output voltage	: 1 V _{p-p} / 50 Ω
Output waveform	: Square
Output impedance	: 50 Ω (nominal), AC coupling
Connector	: Rear panel, BNC connector

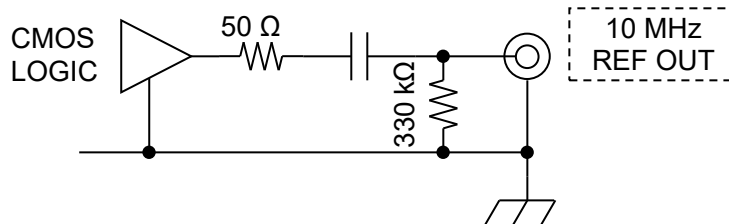
**⚠ CAUTION**

- Applying an external signal to the 10 MHz REF OUT connector will damage the internal circuits. Never input a signal to the 10 MHz REF OUT connector.
- The BNC ground of the 10 MHz REF OUT connector is connected to the enclosure. Do not connect signals for which there is a difference in potential relative to the enclosure. Doing so may damage the instrument.

3.3 Outline of operation screen

3.3.1 Menu operation

Most of the settings for this instrument are done by touch operation of menus and dialog windows on the LCD screen. The basic menu operation is explained here.

A screen with no menus at all is presented immediately after startup, as shown below. For explanation, all of the items of the measurement conditions display area are displayed.

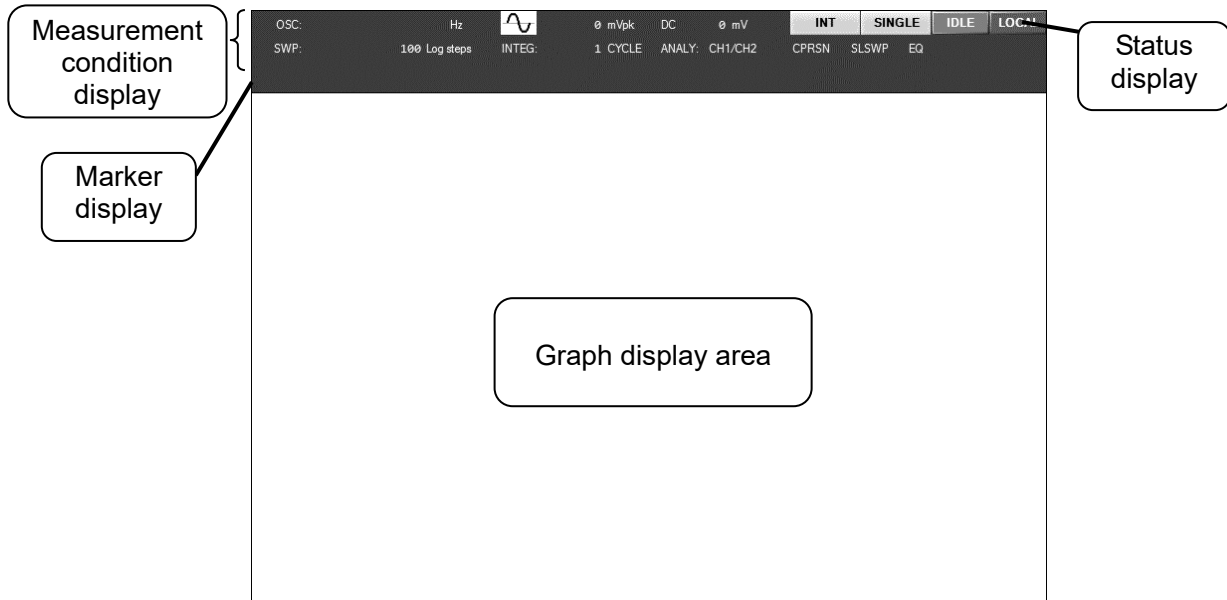

Figure 3-10 Screen immediately after startup

■ Measurement conditions display area

The main current setting states (measurement conditions) are displayed in this area. The meanings of the abbreviations and display items are described below.

[From the upper left]

- OSC : This represents the current output state of the oscillator. In order from the left, the frequency, waveform, AC voltage, and DC bias are displayed. The AC voltage and DC bias are displayed as 0 V when the output is in the off state, regardless of the setting.

[From the lower left]

- SWP : Displays the sweep resolution
- INTEG : Displays the number of integrations or the integration time
- ANALY : Displays the analysis mode

The following items are displayed when the respective functions are on and are not displayed when the functions are off.

- CPRSN : This is displayed when the amplitude compression function (AMPLITUDE COMPRESSION) is on.
- SLSWP : This is displayed when the automatic density sweep function (SLOW SWEEP) is on.
- EQ : This is displayed when the equalizing function (EQUALIZING) is on.

- OP : This is displayed when the open correction function (OPEN CORRECTION) is on.
- SH : This is displayed when the short correction function (SHORT CORRECTION) is on.
- LD : This is displayed when the load correction function (LOAD CORRECTION) is on.
- PX : This is displayed when the port extension function (PORT EXTENTION) is on.

EQ is enabled when the display unit setting is GAIN. OP, SH, LD, and PX are effective when the display unit setting is IMPEDANCE. For information on the display unit setting, refer to "3.5.4 Graph dialog".

■ Status display

This indicates the status of the instrument (remote control, measurement in progress, etc.).

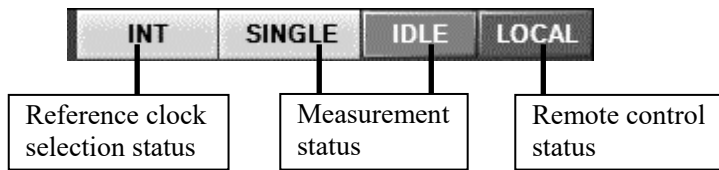

• Reference clock selection status

- INT** : Operating on the internal reference clock
- EXT** : Operating on an external reference clock

• Measurement status

- CAL** : Calibrating
- SINGLE IDLE** : Idle
- SINGLE SPOT** : Spot measurement
- SINGLE UP** : Upsweep
- SINGLE DOWN** : Downsweep
- REPEAT IDLE** : Idle (repeat mode)
- REPEAT SPOT** : Spot measurement (repeat mode)
- REPEAT UP** : Upsweep (repeat mode)
- REPEAT DOWN** : Downsweep (repeat mode)

In single mode (front panel **REPEAT** lamp is not lit), the instrument goes into the idle state (IDLE) when the measurement is completed.

In repeat mode (front panel **REPEAT** lamp is lit), the same measurement is performed again when the measurement is completed. For sweep measurements, the sweep measurement is performed again over the same sweep frequency range.

• Remote control status

- LOCAL** : Local state
- REM** : Remote control state
- LLO** : Local with lockout state

■ Marker display

The marker value for reading measurement data is displayed. For the operating method and function details, refer to "3.5.5 Marker dialog" and "5.6 Marker operations".

■ Top menu

Pressing the **MENU** key when no menus are currently displayed ("Figure 3-10 Screen immediately after startup", etc.) displays the top menu ("Figure 3-11 Top menu").

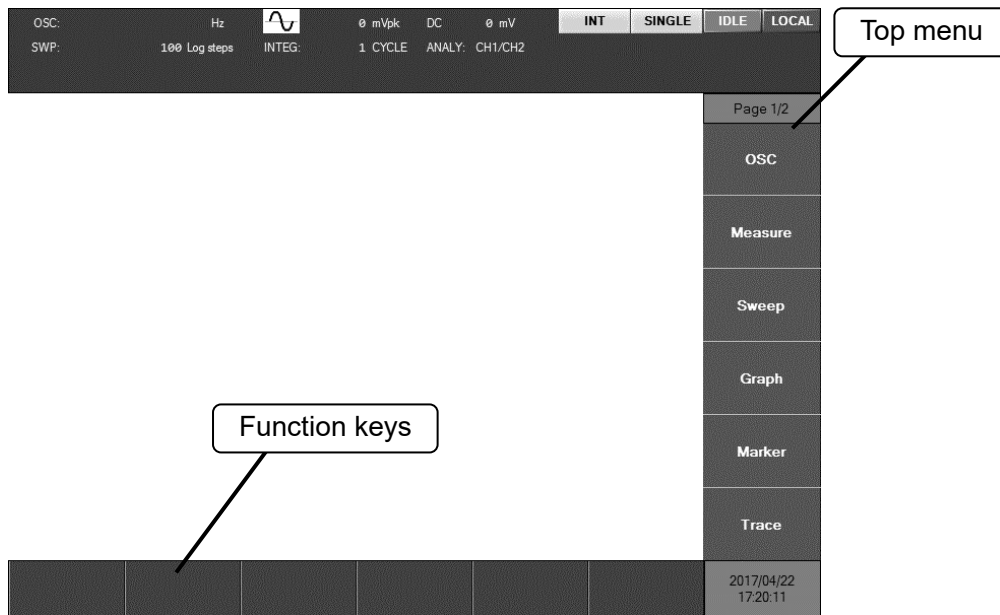

Figure 3-11 Top menu

The top menu has two pages. The current page number is displayed at the top of the menu ("Page 1/2", "Page 2/2"). Each time the **MENU** key is pressed, the display is moved to the next display in the continuous sequence of Page 1/2 → Page 2/2 → (top menu clear) → Page 1/2 → ...

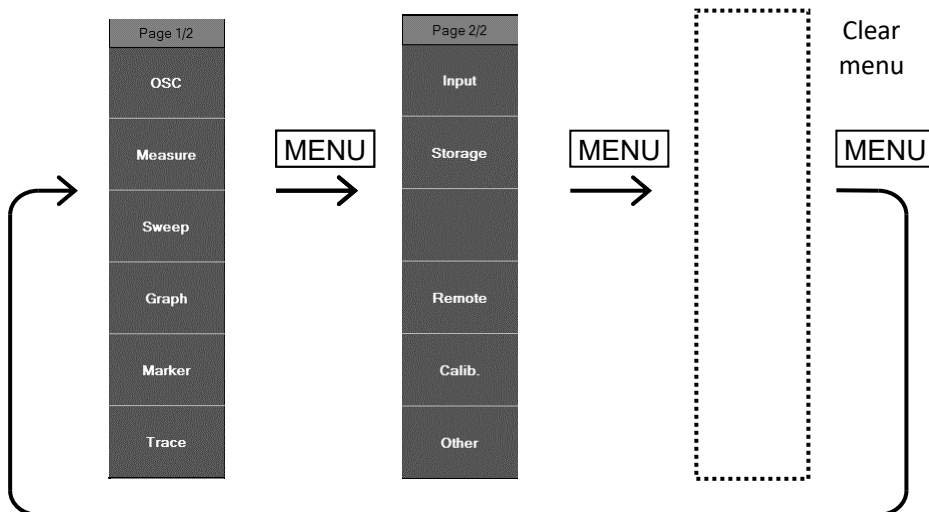

Figure 3-12 Top menu switching

■ Function keys

The display changes according to the settings dialog. Tap on a function name on the screen to invoke that function.

■ Settings dialog

Tap on the top menu to be set and the settings dialog will be presented.

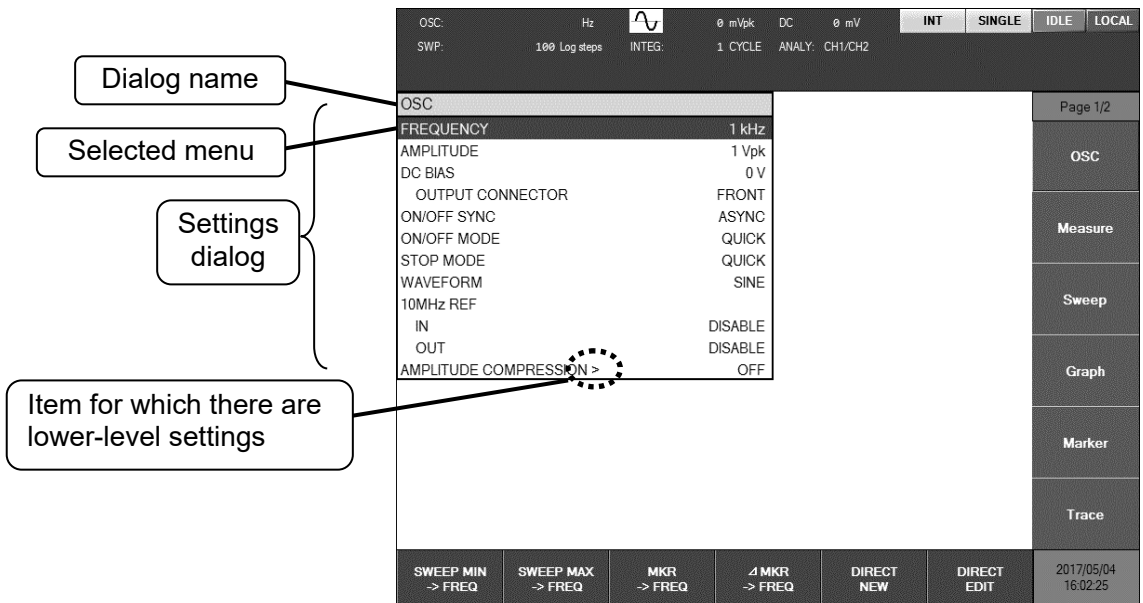

Figure 3-13 Example of a settings dialog

In the settings dialog window, the selected menu item is highlighted. You can change the selected item by using the up and down cursor keys or turning the knob. You can also make selections by tapping directly on the screen.

The settings dialogs are hierarchical. Menu items for which ">" appears at the end have subitems. Selecting lines that end in ">" and pressing the **ENTER** key opens a lower level settings dialog window. To return to the upper level window, press the **CANCEL** key. As you descend the hierarchy, one ">" character is superadded at the end of the dialog window name.

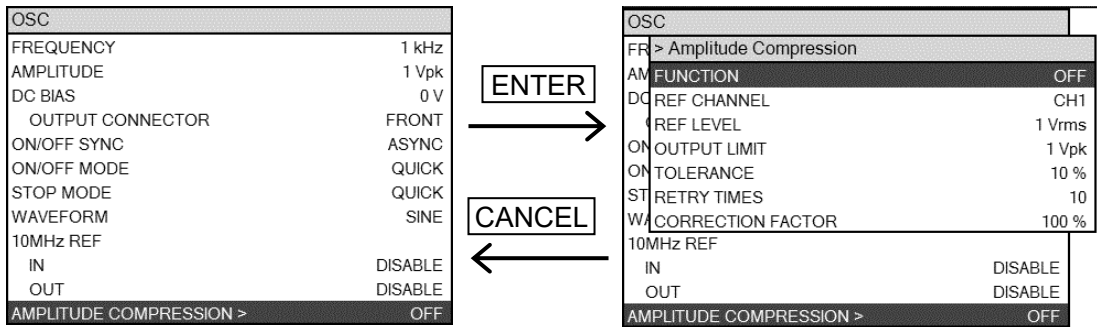

Figure 3-14 Navigating the menu hierarchy

You can change the settings by selecting the menu to be set and pressing either the **ENTER** key or a key on the keypad. The operation differs depending on the setting parameter type (numerical value, list selection, text string, etc.), so the operation for each parameter type is explained below. For the actual settings (frequency, amplitude, etc.), refer to "3.5 Operation screen reference".

■ Numerical settings (immediate)

You can change parameters by selecting a menu and then pressing the **ENTER** key. Use the left and right keys to move the cursor to the digit that you want to change. The digit to be changed will be highlighted. Use the up-and-down keys or turn the knob to increase or decrease the value of the selected digit.

Pressing the up key or turning the knob clockwise will change the value sequentially in the order of 0 → 1 → 2 → 3 → 4 → ... → 9 → 0 → 1 →. Pressing the down key or turning the knob counterclockwise will change the values in the reverse direction.

Changes are immediately applied to the instrument. (The AC amplitude and DC bias are exceptions. The actual output signal is not changed until the **AC/DC ON** key is pressed.)

Change operations that exceed the set range are not possible.

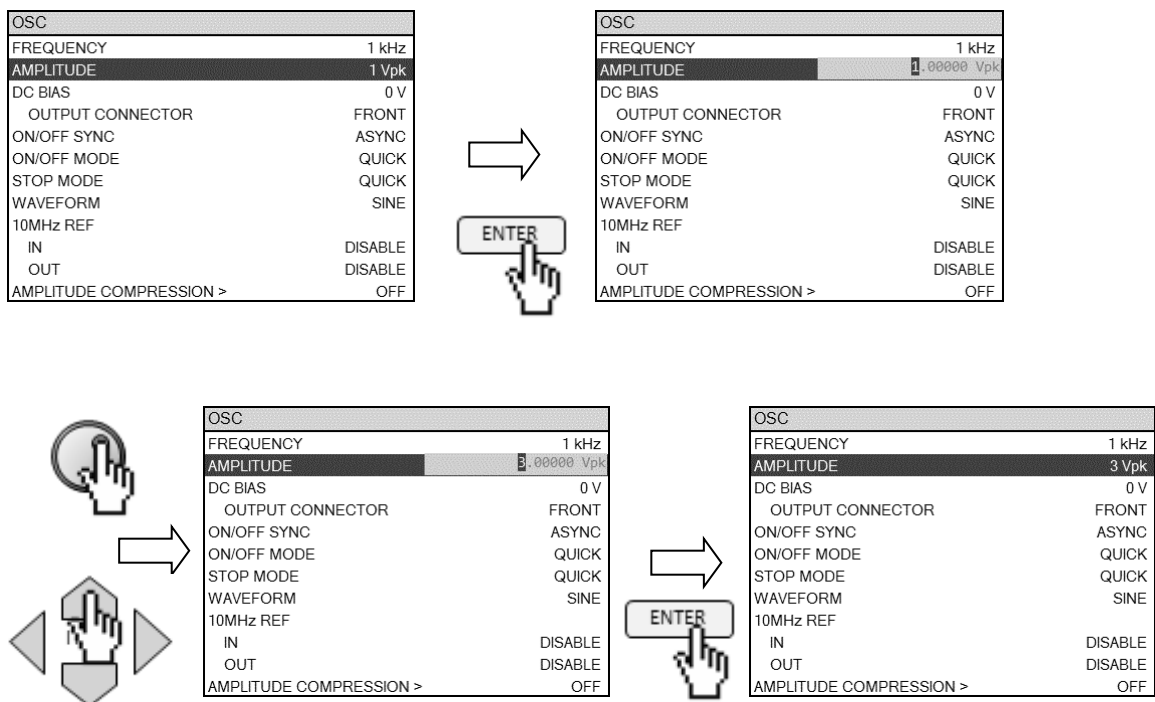

Pressing the **ENTER** key exits the parameter change mode and returns to the normal menu display.

Pressing the **CANCEL** key also returns to the menu display, but the changes that are made up to that time are not canceled and the value that was last changed becomes effective.

■ Numerical settings (confirming)

This operation is the same as the numerical value settings (immediate) described above, but the changes do not become effective until the **ENTER** key is pressed.

A range check is performed when the **ENTER** key is pressed, and if a value that lies outside the set range has been entered, an error message is displayed and the setting is returned to the value prior to the change. If the **CANCEL** key is pressed, the change operations that have been performed up to that time (up and down keys or knob) are canceled and the parameter values are returned to the original values.

■ Numerical settings (new input)

If any of the number keys **0** to **9** of the ENTRY keypad on the front panel are pressed or if the function key **[DIRECT NEW]** at the bottom of the LCD screen is tapped while the menu is selected, the numerical value input dialog **[NUM]** is displayed on the LCD screen. Numerical values that have been input with the front panel ENTRY keypad and **[NUM]** dialog are set by pressing the **ENTER** key or tapping the **ENTER** button.

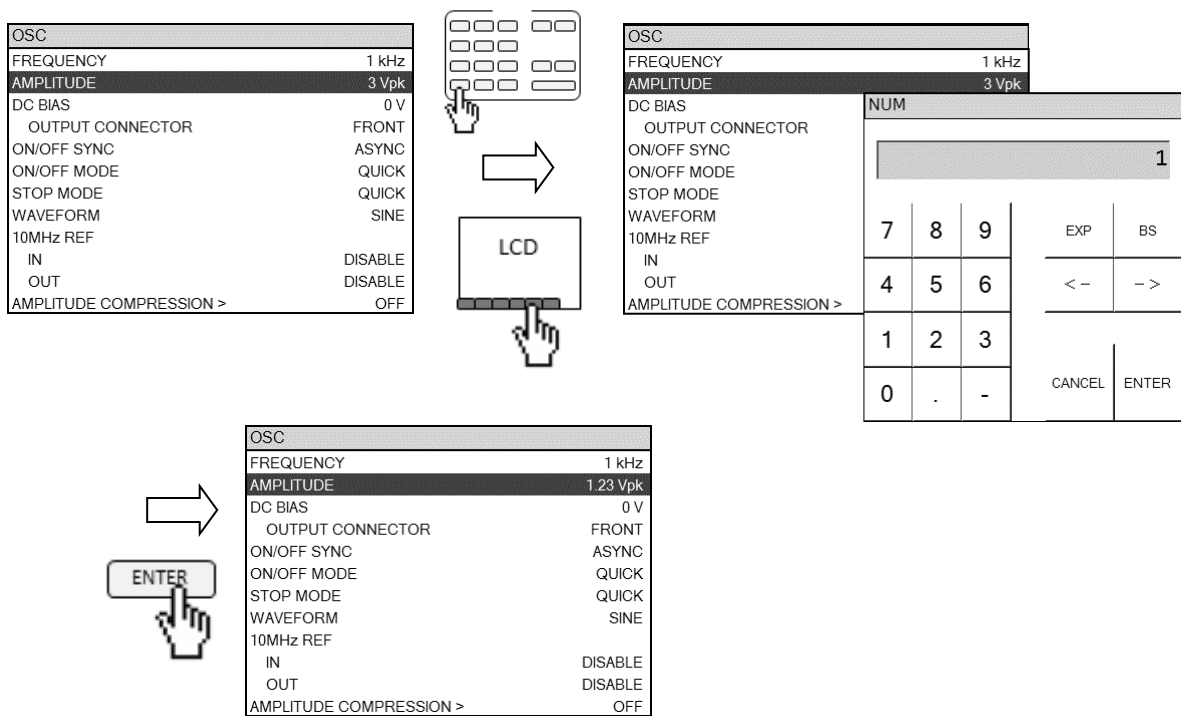

Use the left and right keys to move the cursor position when editing numerical values. The digit to the left of the cursor can be deleted by pressing the **BS** key or tapping on the **[BS]** button (backspace operation).

The **EXP** key (or **[EXP]** button) stands for the exponent (power of 10) and "e" is displayed in the value input area. For example, pressing **1**, **2**, **.**, **3**, **e**, **-**, **1**, **2**, and **ENTER** results in 12.3×10^{-12} .

Pressing the **CANCEL** key (or tapping the **[CANCEL]** button) discards what has been input and returns to the value prior to input.

The function keys are used mainly for entering SI prefixes. It is also possible to add SI prefixes such as "m" and "k" by tapping the function key after entering the numerical value with the numeric keypad.

■ Numerical settings (edit)

With the menu selected, tap on the [DIRECT EDIT] function key at the bottom of the LCD screen to display the 【NUM】 dialog for entering numerical values. The currently set value is displayed and can be edited.

The behavior is the same as "■ Numerical settings (new input)" described above, except that the current set value is already displayed in the numerical value input area when editing begins.

■ List operations (immediate setting)

In this operation, the settings are made by choosing one from several options, such as waveforms (sinusoidal, square, triangular).

With the menu selected, press the **ENTER** key to open a list box. Use the up and down keys or turn the knob to move the cursor. Each time the cursor is moved, the currently highlighted item is set. Pressing either the **ENTER** key or the **CANCEL** key closes the listbox and makes the setting fixed with the highlighted item.

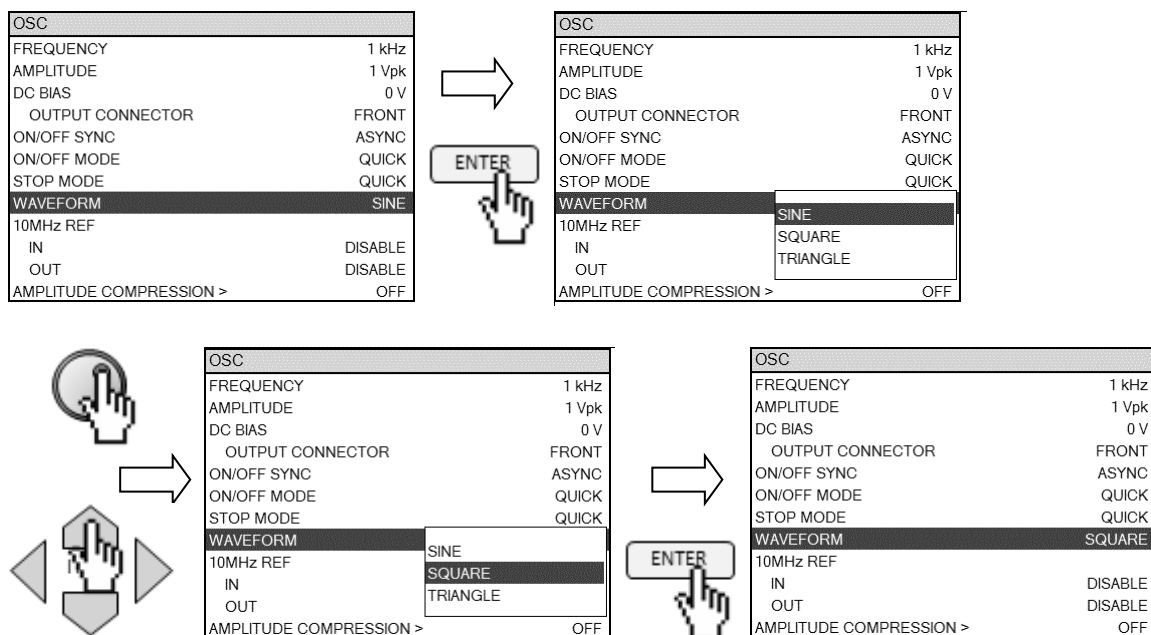

■ List operations (confirming)

This operation is the same as "■ List operations (immediate setting)" described above, but the changes do not become effective until the **ENTER** key is pressed and the list box is closed. When the **CANCEL** key is pressed, the operations up to that time (up and down key or knob operations to move the cursor) are discarded and the previous setting is restored.

■ Text settings (immediate)

The operation is the same as "■ Numerical settings (immediate)" described previously, but alphabetic characters and symbols can be used in addition to numerals.

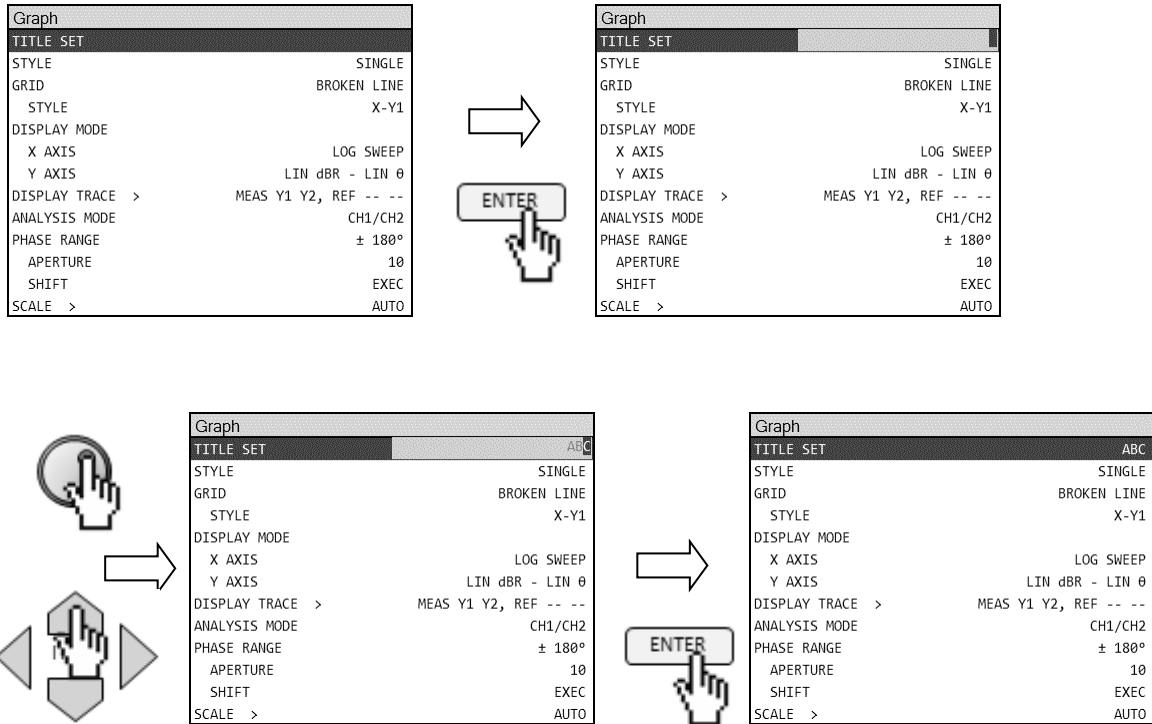

The editing mode is exited and the edited text is set by pressing the **ENTER** key or the **CANCEL** key.

The characters that can be used with this instrument are shown below. However, some of the characters cannot be input for some items, such as file names.

A B C D E F G H I J K L M N O P Q R S T U V W X Y Z
a b c d e f g h i j k l m n o p q r s t u v w x y z
0 1 2 3 4 5 6 7 8 9 ! " # \$ % & ' () - = ^ ~ ¥ | @
` [] { } ; : + * , . < > / ? _ (space)

■ Text settings (confirming)

This operation is the same as "■ Numerical settings (confirming)", but alphabetic characters and symbols can be used in addition to numerals. The values are set by pressing the **ENTER** key. Pressing the **CANCEL** key discards the input and restores the text as it was prior to editing.

■ Text settings (new input)

If any of the number keys **0** to **9** of the ENTRY keypad on the front panel are pressed or if the function key **[DIRECT NEW]** at the bottom of the LCD screen is tapped while the menu is selected, the text input dialog **【TEXT】** is displayed on the LCD screen.

Text that has been input with the front panel ENTRY keypad and **【TEXT】** dialog is set by pressing the **ENTER** key or tapping the **[ENTER]** button.

Pressing the **CANCEL** key (or tapping the **[CANCEL]** button) discards what has been input and returns to the text prior to input.

The editing operations (**BS** key and left and right keys) are the same as for numerical value settings (new input) as described above.

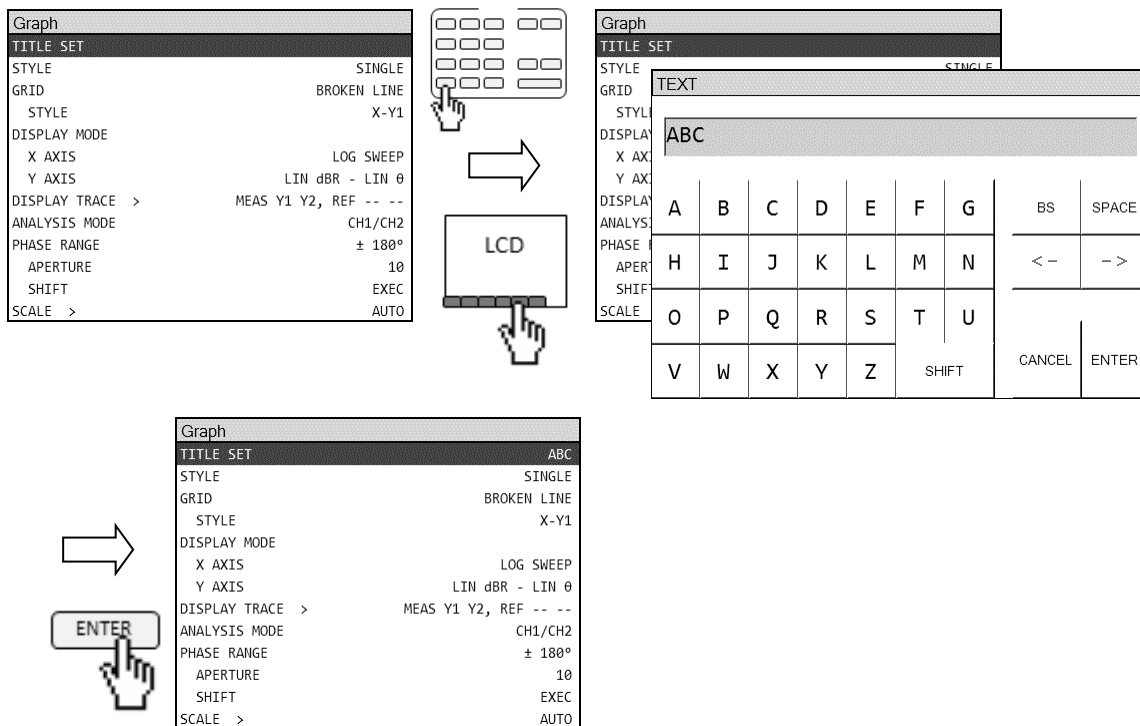

3.3 Outline of operation screen

Tapping on the [SHIFT] button of the 【TEXT】 dialog changes the character set of the 【TEXT】 dialog.

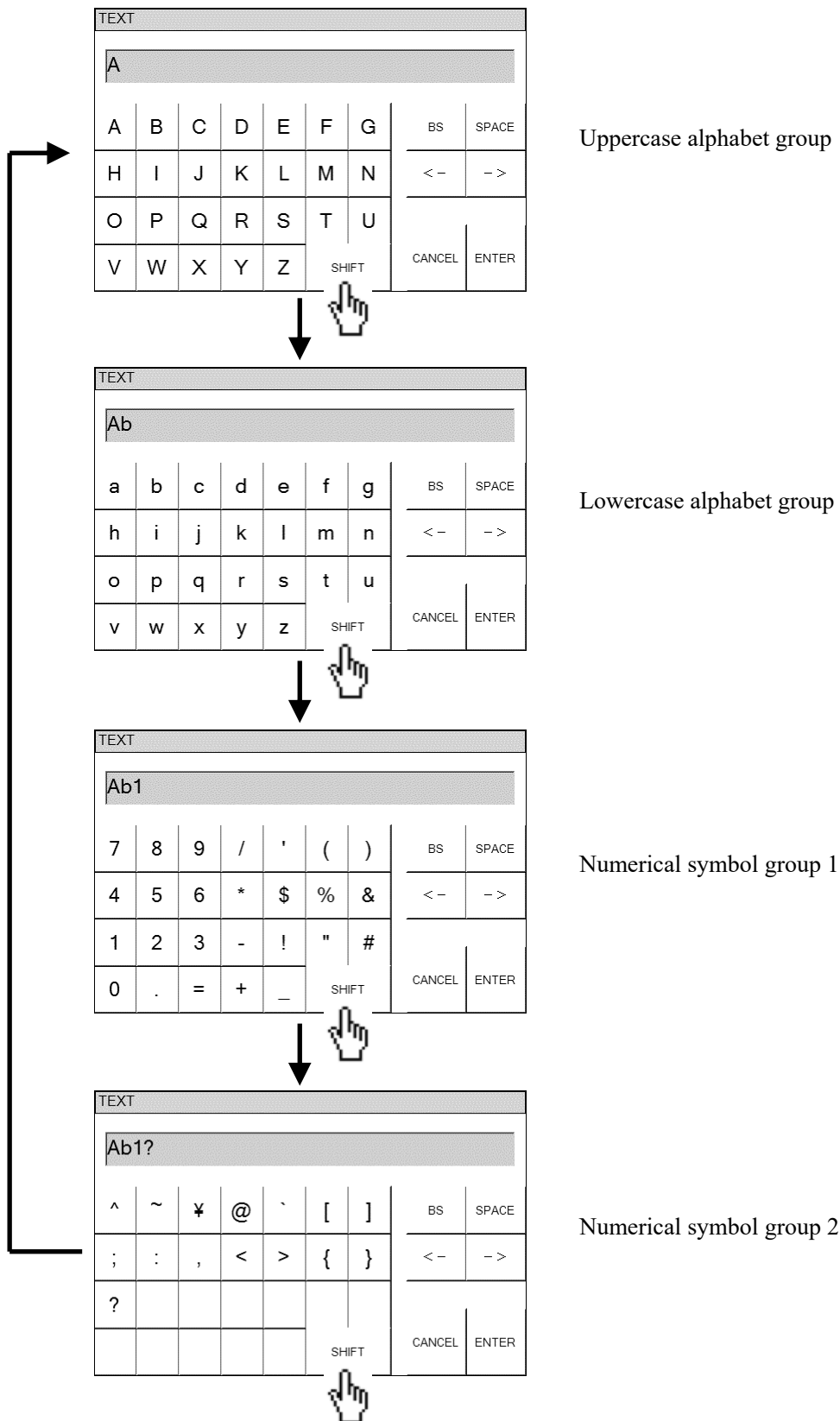

■ Text settings (edit)

With the menu selected, tap on the [DIRECT EDIT] function key at the bottom of the LCD screen to display the [TEXT] dialog for entering text. The currently set value is displayed and can be edited.

The operation is the same as "■ Text settings (new input)", except that the current set value is already displayed in the numerical value input area when the editing begins.

■ Execution operations (selection)

To open the listbox for the selected menu, press the **ENTER** key. Select an item in the listbox for execution by using the up and down keys or turning the knob and then press the **ENTER** key to execute the selected function. To close the listbox without executing any function, press the **CANCEL** key.

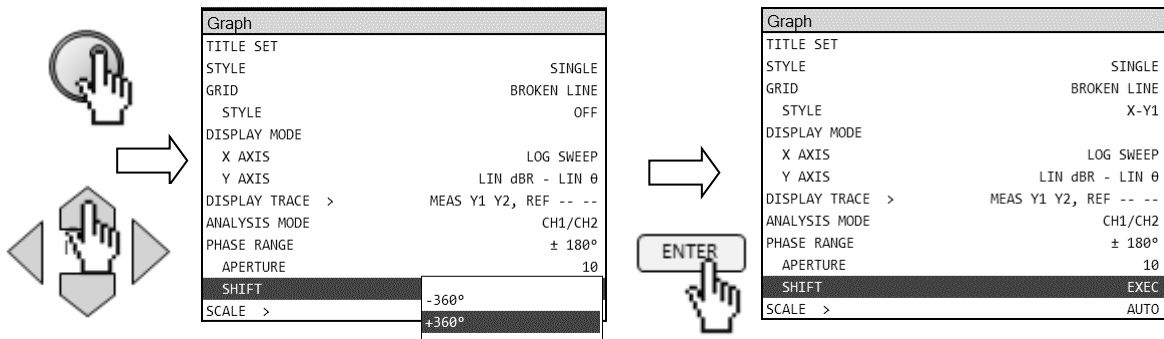
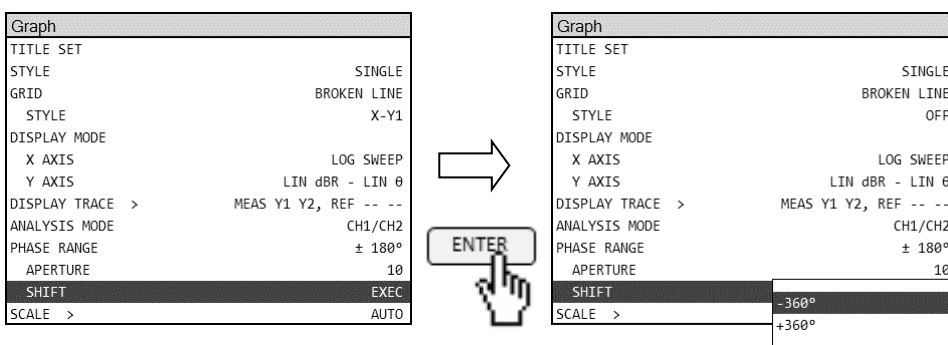

■ Execution operations (confirming)

To open a confirmation dialog for the selected menu, press the **ENTER** key. To execute the selected function, tap on the [OK] button of the confirmation dialog. To cancel the operation, tap on the [CANCEL] button. The confirmation dialog is presented for operations that involve major changes, such as initializing all settings, etc.

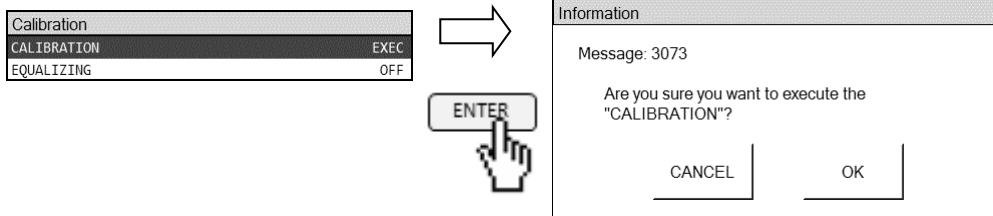

3.3.2 Outline of graph display

■ Graph axes

The graphs used to display measurement data on this instrument have three axes: X, Y1, and Y2. The graphs also have two display layout styles (SINGLE and SPLIT). The display style can be set using the [Graph] – [STYLE] menu.

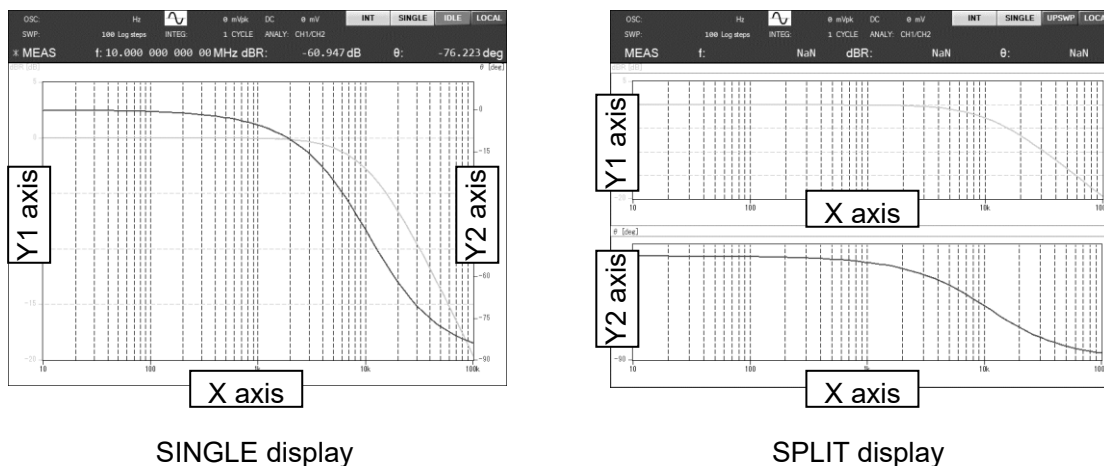

Figure 3-15 Graph display styles

In the SINGLE display style, Y1 is the left vertical axis and Y2 is the right vertical axis. In the SPLIT style, two graphs are displayed, one above the other, with Y1 as the left vertical axis of the upper graph and Y2 as the left vertical axis of the lower graph. The X axis is the same for both graphs.

■ Types of display data

The two types of data that are displayed in graph form are measurement data (MEAS DATA) and reference data (REF DATA). The result of sweep measurements are MEAS DATA. MEAS DATA traces are updated during sweep measurement operation. The reference data can be updated by copying measurement data with a menu operation.

The MEAS DATA and REF DATA traces can be individually set to be displayed or to be hidden in the graph.

■ Markers

Two types of markers are used to specify the range for reading X, Y1, and Y2 values of the data trace in a graph: main markers and delta markers. The delta marker is used for reading X, Y1, and Y2 axis difference values relative to the main marker. The value is displayed in the marker display area in the upper part of the LCD screen.

The main marker is displayed on the graph as “*” and the delta marker is displayed as “△”. The data that is referenced by the markers can be set to measurement data (MEAS DATA) and reference data (REF DATA) by using the **ACTIVE** and **△SET** keys.

3.4 Operation tree

The operation tree for operating this instrument from its panels is presented below. For more information on the keys and screen notation, please refer to "3.1 Function and use of each part of the panels".

Front panel

MENU key	: Top menu display on/off
ENTER key	: Confirm setting
CANCEL/ESC	: Cancel setting
BASIC SETUP key	: Open dialogue that lists frequently-set parameters
[SWEEP LOWER]	: Set the sweep lower frequency limit
[SWEEP UPPER]	: Set the sweep upper frequency limit
[AMPLITUDE]	: Set the AC amplitude
[INTEGRATION]	: Set the integration count or time.
Up/down/left/right keys	: Move the cursor and change numerical values
Modifying knob	: Select menus, change parameters, and move markers, etc.
SCREEN COPY key	: Print an image of the LCD screen
LOCAL key	: Return the instrument to local control state
(Oscillator control keys)	
AC/DC OFF key	: Turn AC and DC outputs both off
AC OFF key	: Turn only the AC output off
AC/DC ON key	: Turn the AC and DC outputs both on
AC lamp	: Lit during AC output
DC lamp	: Lit during DC output
(Measurement control keys)	
DOWN key	: Start downsweep measurement
SPOT key	: Start spot measurement
UP key	: Start upsweep measurement
STOP key	: Stop measurement
REPEAT key	: Toggle between single measurement and repeat measurement
REPEAT lamp	: Lit while in repeat measurement mode

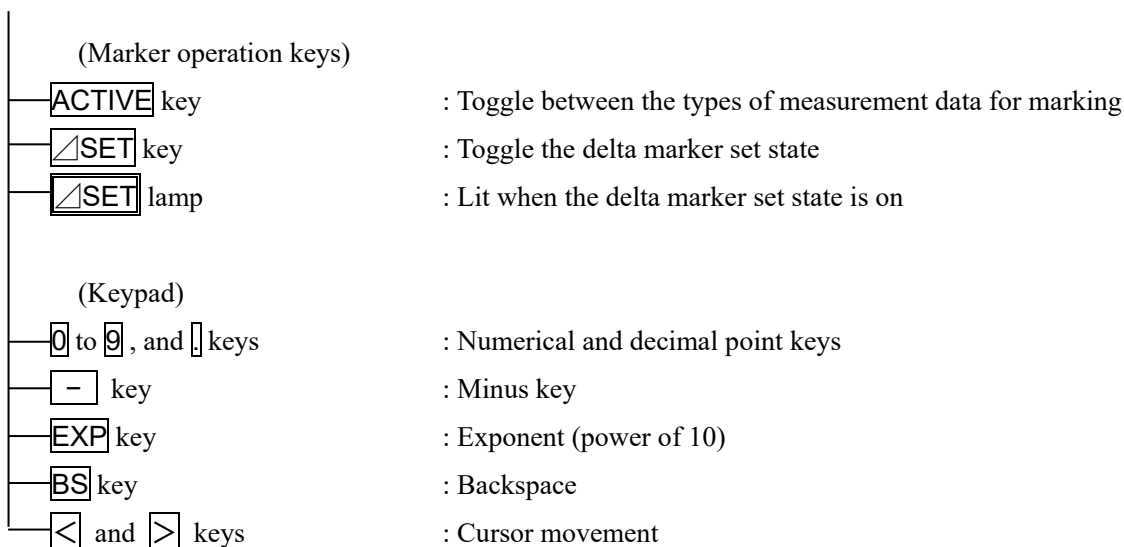

Top menu 1/2

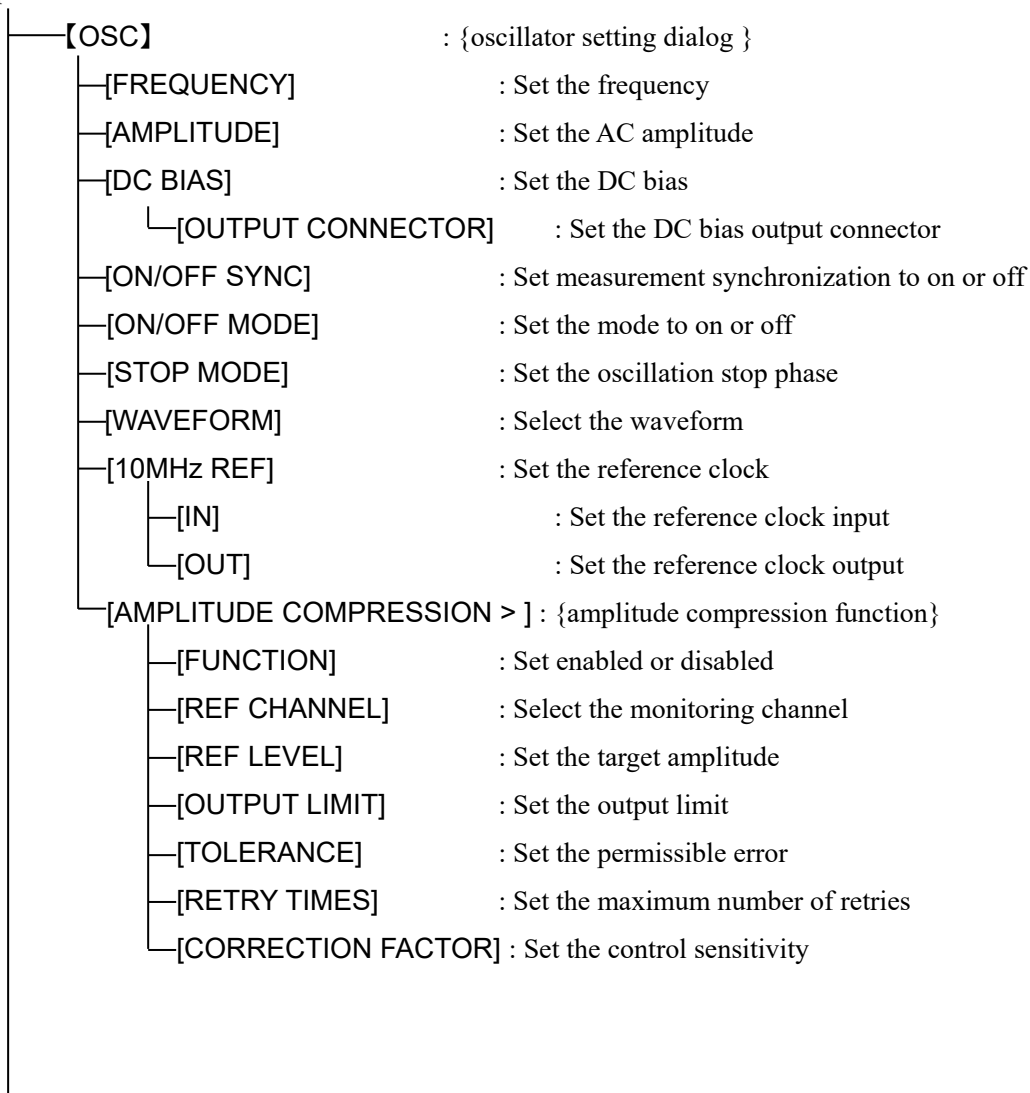

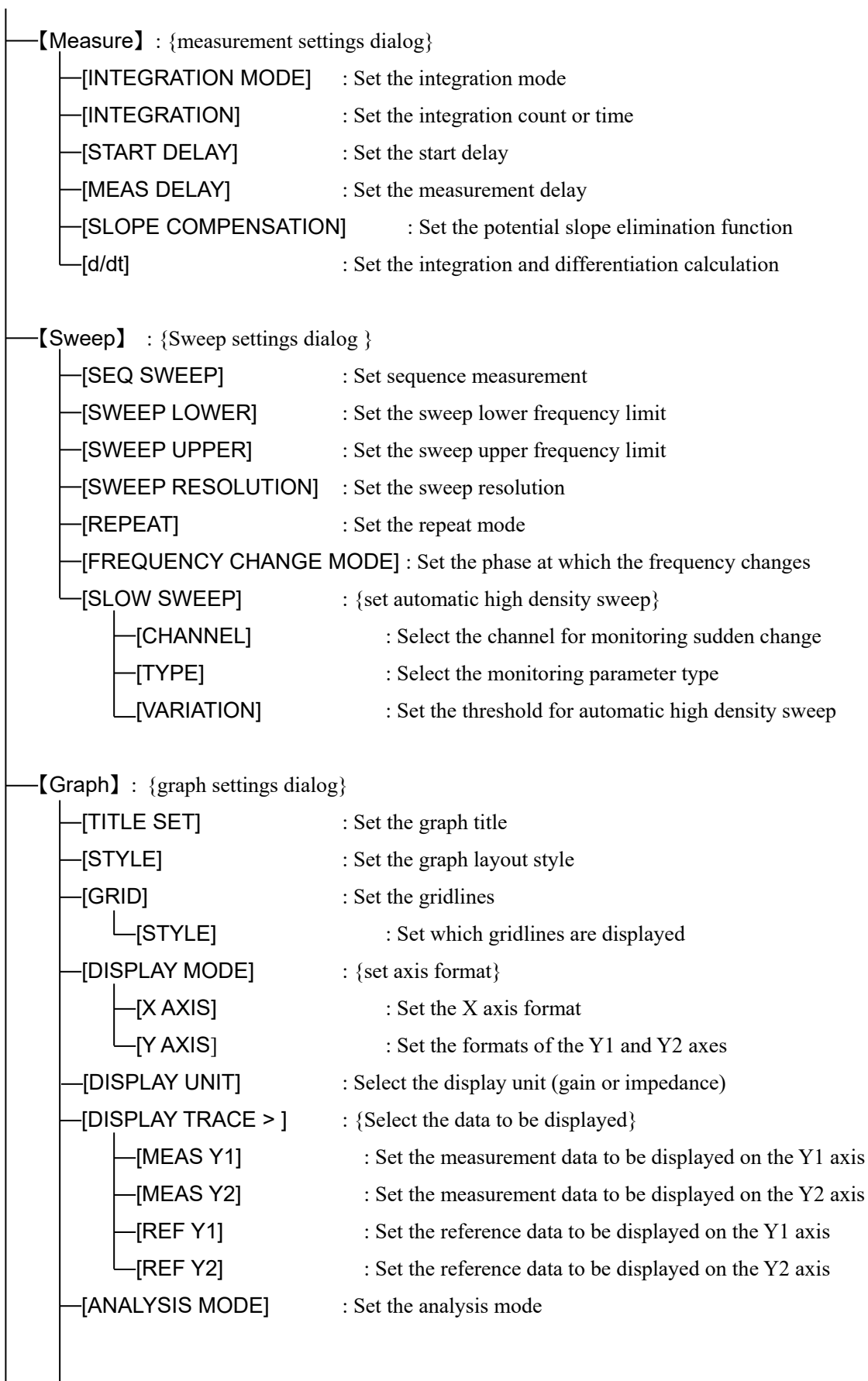

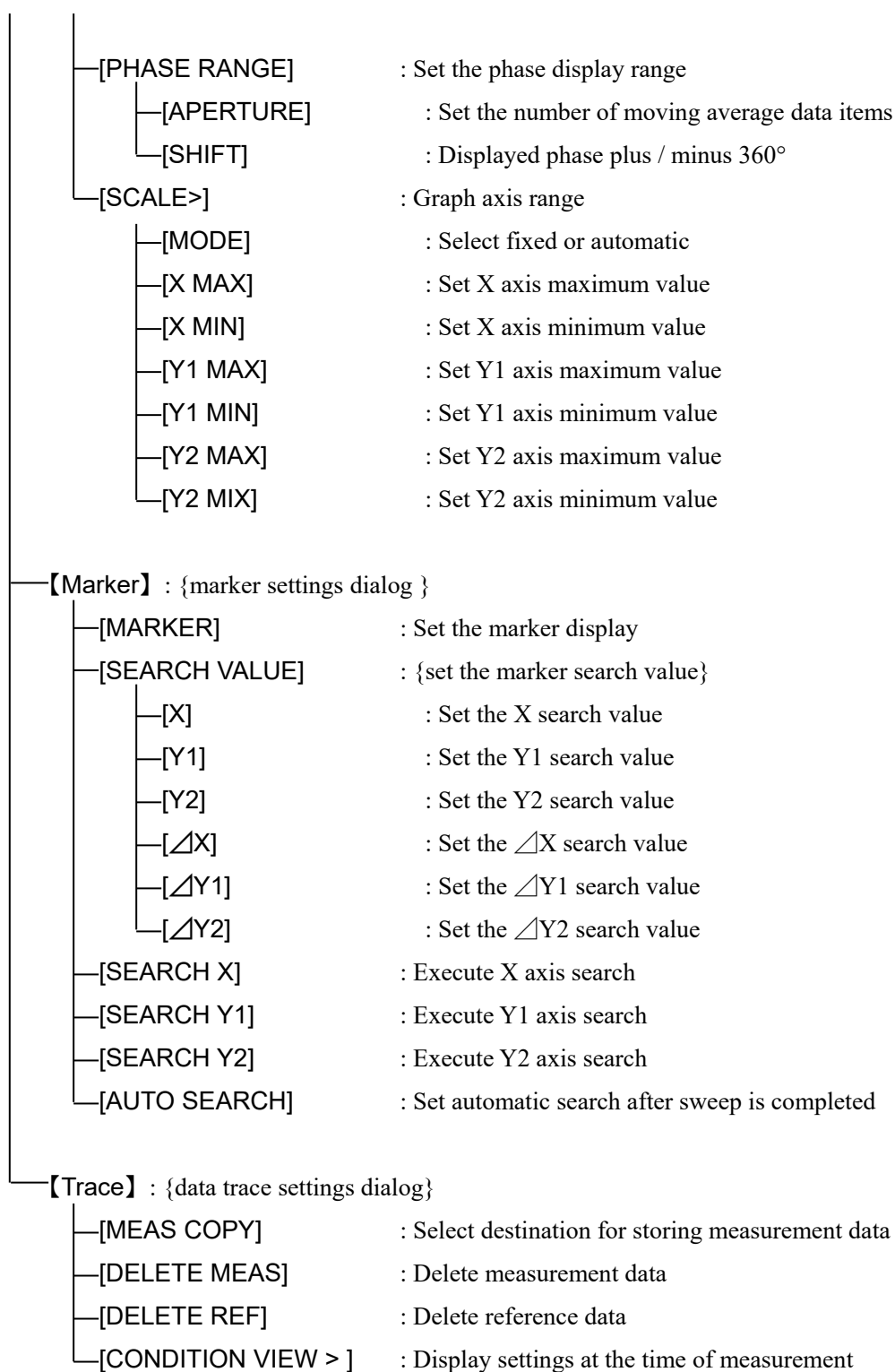

Top menu 2/2

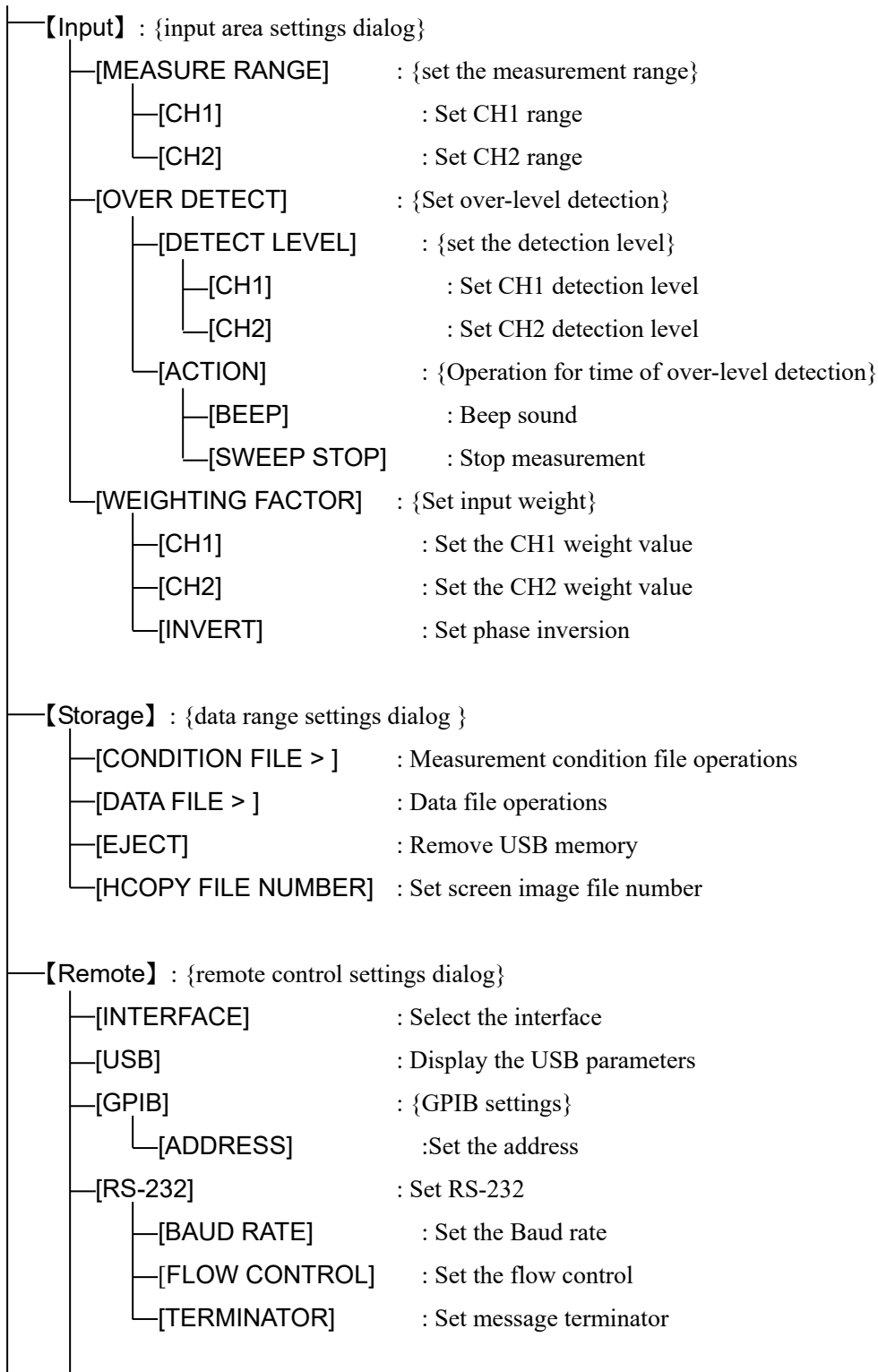

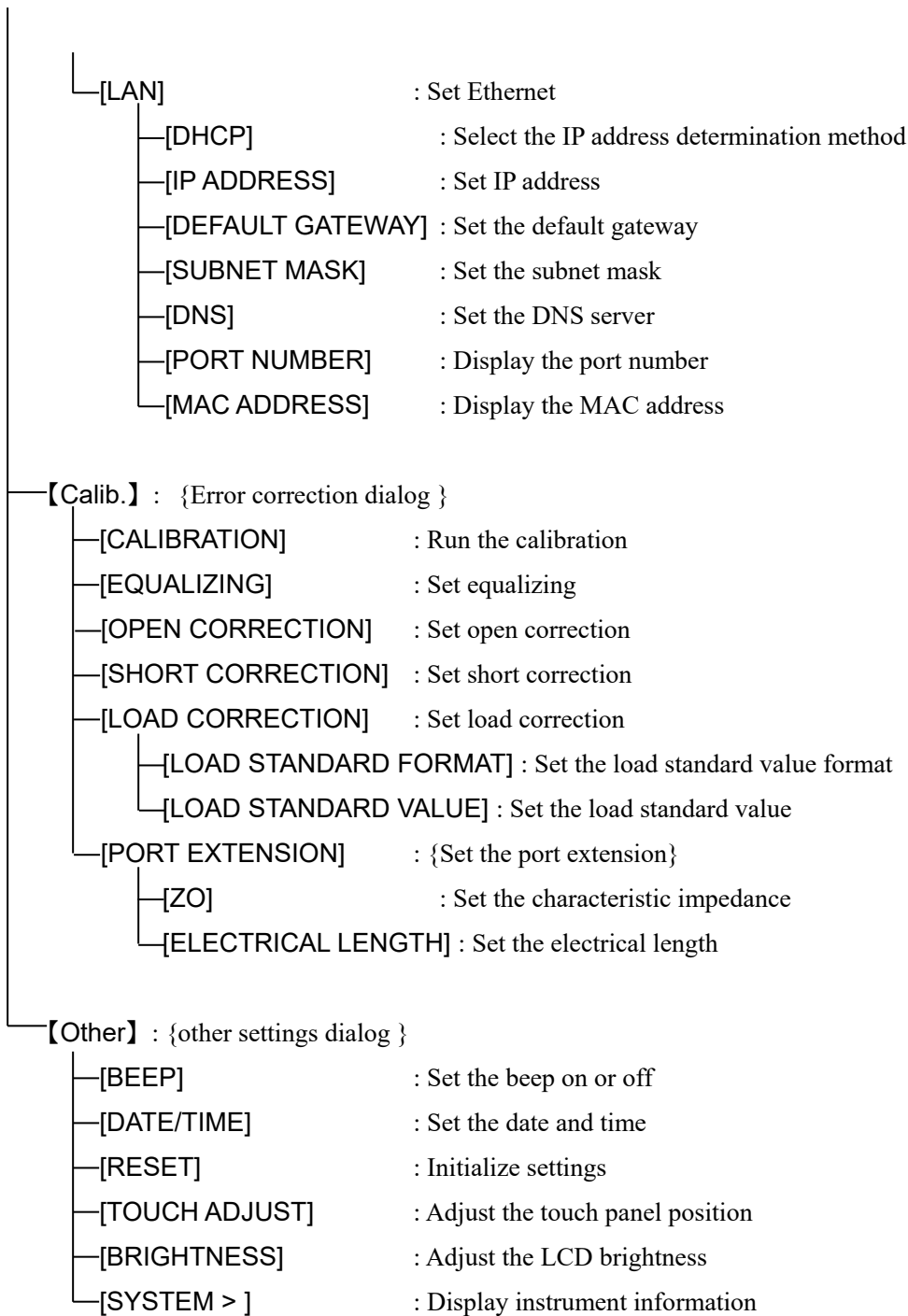

3.5 Operation screen reference

Various settings screens are explained in this section.

In the menu explanations that begin on the next page, the methods for performing parameter setting and changing use the format shown below.

- < Numerical value settings (immediate) >
- < Numerical value settings (confirming) >
- < Numerical value settings (new input) >
- < Numerical value settings (edit) >
- < List operations (immediate) >
- < List operations (confirming) >
- < Text settings (immediate) >
- < Text settings (confirming) >
- < Text settings (new input) >
- < Text settings (edit) >
- < Execution operations (selection) >
- < Execution operations (confirm) >

The methods correspond to the descriptions in "3.3.1 Menu operation", so please refer to that section for further information.

3.5.1 OSC dialog

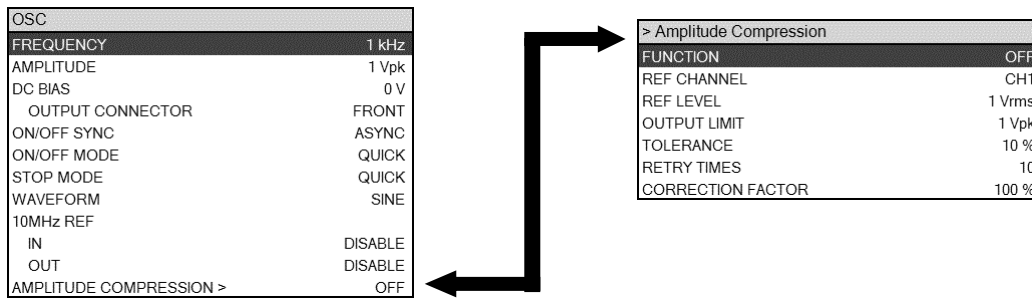

■ [FREQUENCY] : Set the frequency

This is the frequency of the signal that is output from the OSC connector. The frequency at which a spot measurement is performed (measurement at a fixed frequency) is set. After a sweep measurement, however, the value is replaced by the last measured frequency. If the sweep is interrupted, the frequency at the time of interruption is set.

○ Setting method

< Numerical value settings (immediate setting) > , < Numerical value settings (new input) > ,
< Numerical value settings (edit) >

○ Function key functions

- [SWEEP MIN → FREQ] : Copy the sweep lower frequency limit to FREQUENCY.
- [SWEEP MAX → FREQ] : Copy the sweep upper frequency limit to FREQUENCY.
- [MKR → FREQ] : Copy the main marker frequency to FREQUENCY.
- [ΔMKR → FREQ] : Copy the delta marker frequency to FREQUENCY.
- [DIRECT NEW] : Set the frequency with the numerical input dialog **[NUM]** .
- [DIRECT EDIT] : Edit the frequency setting with the numerical input dialog **[NUM]** .

○ Functions of the function keys set with the numerical input dialog **[NUM]**

- [uHz] : Set with the entered value in units of μHz.
- [mHz] : Set with the entered value in units of mHz.
- [Hz] : Set with the entered value in units of Hz.
- [kHz] : Set with the entered value in units of kHz.
- [MHz] : Set with the entered value in units of MHz.

The setting range is 10 μHz to 15 MHz; The setting resolution is 10 μHz.

■ [AMPLITUDE] : Set the AC amplitude.

This is the amplitude of the signal that is output from the OSC connector. The unit is peak voltage (Vpk). The setting range is 0 to 10 Vpk, but it is limited to ± 10 V total, summed with the DC bias setting (DC BIAS).

$$|\text{DC bias setting (V)}| + \text{AC amplitude setting (Vpk)} \leq 10.0 \text{ V}$$

○ Setting method

< Numerical value settings (immediate setting) > , < Numerical value settings (new input) > ,
< Numerical value settings (edit) >

○ Function key functions

- [DIRECT NEW] : Set the amplitude with the numerical input dialog **【NUM】** .
- [DIRECT EDIT] : Edit the amplitude setting with the numerical input dialog **【NUM】** .

○ Functions of the function keys set with the numerical input dialog **【NUM】**

- [uVpk] : Set with the entered value in units of μVpk .
- [mVpk] : Set with the entered value in units of mVpk .
- [Vpk] : Set with the entered value in units of Vpk .

(Additional explanation)

Even if the AC amplitude setting is changed, the output voltage does not change until the **AC/DC ON** key is pressed.

■ [DC BIAS] : The DC bias setting

The DC bias (direct-current voltage) is set.

The setting range is -10 to $+10$ V, but it is limited to ± 10 V together with the AC amplitude setting (AMPLITUDE).

$$|\text{DC bias setting (V)}| + \text{AC amplitude setting (Vpk)} \leq 10.0 \text{ V}$$

○ Setting method

< Numerical value settings (immediate setting) > , < Numerical value settings (new input) > ,
< Numerical value settings (edit) >

○ Function key functions

- [DIRECT NEW] : Set the DC bias with the numerical input dialog **【NUM】** .
- [DIRECT EDIT] : Edit the DC bias with the numerical input dialog **【NUM】** .

○ Functions of the function keys set with the numerical input dialog **【NUM】**

- [mV] : Set with the entered value in units of mV .
- [V] : Set with the entered value in units of V .

(Additional explanation)

- Even if the AC amplitude setting is changed, the output voltage is not changed unless the **AC/DC ON** key is pressed.
- The DC bias is output to either the OSC connector on the front panel or to the DC BIAS OUT connector on the rear panel. The DC bias is output only to the selected connector. The output connector is set by [OUTPUT CONNECTOR].

■ [DC BIAS] – [OUTPUT CONNECTOR] : Set the DC bias output connector

This sets the connector from which the DC bias voltage is output.

○ Setting method

< List operations (confirming) >

- FRONT: The DC bias voltage is output from the OSC connector.
- REAR: The DC bias voltage is output from the DC BIAS OUT connector.

(Additional explanation)

Even if the DC bias output connector is changed, the connector from which the DC bias is output does not change until the **AC/DC ON** key is pressed.

■ [ON/OFF SYNC] : Set the measurement synchronization driving.

Measurement synchronization driving is a function for outputting a signal only during measurement. It is used when the signal is to be applied to the equipment under test only during measurement. The output is turned on at the beginning of measurement and is automatically turned off when the measurement is completed.

○ Setting method

< List operations (confirming) >

- ASYNC : Measurement synchronization is off. On-off control of the output is not performed.
- SYNC (AC + DC) : Measurement synchronization is on. The AC and DC outputs are both turned on at the beginning of measurement, and both are turned off when the measurement is completed.
- SYNC (AC) : Measurement synchronization is on. The AC and DC outputs are both turned on at the beginning of measurement, and only the AC is turned off when the measurement is completed.

If repeat measurement is performed while the measurement synchronization is on, the output is not turned off even if one round of measurement is completed for either spot measurement or sweep measurement (one sweep).

■ [ON/OFF MODE] : Set the on/off mode.

This selects whether to turn the oscillator output on or off instantaneously, or to change the AC amplitude or DC bias gradually over an interval of about 10 seconds. This is used to avoid sudden signal changes such as when the equipment under test is a mechanical system.

○ Setting method

< List operations (confirming) >

- QUICK : Instant on/off
- SLOW : The output is turned on or off slowly over a period of about 10 seconds.

■ [STOP MODE] : Set the oscillation stop phase.

This selects whether to stop the oscillation instantaneously or to wait until the 0° phase of a sine function before stopping the oscillation. This is useful for the measurement of electrochemical impedance because the amount of charge transfer can be made zero by equalizing the areas of the positive and negative sides of an AC sinusoidal signal.

○ Setting method

< List operations (confirming) >

- QUICK : Turn off instantly.
- 0° SYNC : Turn off after waiting for 0° phase (stop oscillation).

When 0° SYNC is set, it takes up to one cycle of the signal at the longest from the time the output off operation is performed to the time the output is actually turned off. Please note that, at 10 μHz, it takes up to 10⁵ seconds (27.8 hours) at the longest.

If the [ON/OFF MODE] is set to SLOW and the [STOP MODE] is set to 0° SYNC, the [STOP MODE] setting has priority.

■ [WAVEFORM] : Select the waveform.

This selects the oscillator output waveform from among sinusoidal, square, and triangular. Normally, sinusoidal is used. Main characteristics such as amplitude accuracy and measurement accuracy are specified only for the sinusoidal waveform.

○ Setting method

< List operations (confirming) >

- SINE : Sinusoidal
- SQR : Square
- TRI : Triangular

The square and triangular waveforms should be used for frequencies of 100 kHz and below. At higher in frequencies, waveform quality decreases.

■ [10MHz REF] – [IN] : Set the reference clock input.

This is used to obtain higher frequency accuracy and stability by using an external reference clock that is more accurate than the internal reference clock of the instrument. This is also used to make frequency accuracy common among multiple instruments.

○ Setting method

< List operations (confirming) >

- DISABLE : Use the internal reference clock.
- ENABLE : Use an external reference clock if an external reference clock is available.

Even if ENABLE is set, the internal reference clock of the instrument will be used if an external reference clock is not detected or if the frequency differs from the specified frequency. The reference clock on which the instrument is currently operating is indicated by the status display in the upper part of the LCD screen.

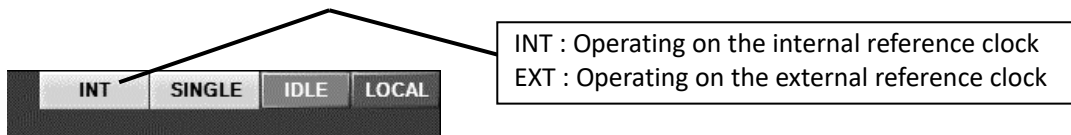

■ [10 MHz REF] – [OUT] : Set the reference clock output

This is set when the reference clock on which the instrument is operating is output from the 10 MHz REF OUT connector on the rear panel. This is done so that this instrument and other devices can operate with the same frequency accuracy.

○ Setting method

< List operations (confirming) >

- DISABLE : The reference clock is not output.
- ENABLE : The reference clock is output.

When the instrument is operating on an external reference clock, the output frequency is the same as that reference clock.

■ [AMPLITUDE COMPRESSION] : Set the amplitude compression function

This is used to automatically adjust the output amplitude of the oscillator to supply a constant amplitude to the circuit being measured. For more information on the amplitude compression function, refer to "5.7 Amplitude compression".

- [Amplitude Compression] – [FUNCTION] : Set to enabled or disabled.

This sets whether or not amplitude compression is performed.

- Setting method

< List operations (confirming) >

- OFF : The amplitude compression function is disabled.
- ON : The amplitude compression function is enabled.

Even if the setting is OFF, the parameter settings related to amplitude compression are not changed.

- [Amplitude Compression] – [REF CHANNEL] : Set the reference channel.

This sets the channel to be used as the signal level reference.

- Setting method

< List operations (confirming) >

- CH1 : Reference CH1 level.
- CH2 : Reference CH2 level.

- [Amplitude Compression] – [REF LEVEL] : Set the target amplitude.

This sets the target amplitude. The OSC amplitude is automatically adjusted so that the signal amplitude level measured at the reference channel is the value that is set here.

- Setting method

< Numerical value settings (immediate setting) > , < Numerical value settings (new input) > ,
< Numerical value settings (edit) >

The setting range is 1 μ Vrms to 600 Vrms. The setting resolution is 3 digits.

- Function key functions

- [DIRECT NEW] : Set the target amplitude with the numerical input dialog **【NUM】** .
- [DIRECT EDIT] : Edit the target amplitude with the numerical input dialog **【NUM】** .

- The function key functions that are being set with the numerical input dialog **【NUM】**

- [mVrms] : Set with the entered value in units of mVrms.
- [Vrms] : Set with the entered value in units of Vrms.

■ [Amplitude Compression] – [OUTPUT LIMIT] : Set the output limit.

This sets the maximum OSC output amplitude. The output amplitude cannot exceed the value set here, even if the target signal amplitude has not been reached.

○ Setting method

< Numerical value settings (immediate setting) > , < Numerical value settings (new input) > ,
< Numerical value settings (edit) >

The setting range is 1 mVpk to 10 Vpk. The setting resolution is 3 digits.

○ Function key functions

- [DIRECT NEW] : Set the output limit with the numerical input dialog **【NUM】** .
- [DIRECT EDIT] : Edit the output limit with the numerical input dialog **【NUM】** .

○ Functions of the function keys set with the numerical input dialog **【NUM】**

- [mVpk] : Set with the entered value in units of mVpk.
- [Vpk] : Set with the entered value in units of Vpk.

■ [Amplitude Compression] – [TOLERANCE] : Set the permissible error.

This sets the permissible error between the target amplitude and the measured amplitude. The OSC amplitude is varied and the measurement is repeated until the error is within the tolerance set here.

○ Setting method

< Numerical value settings (immediate setting) > , < Numerical value settings (new input) > ,
< Numerical value settings (edit) >

The setting range is 1% to 100% and the resolution is 1%.

○ Function key functions

- [DIRECT NEW] : The tolerance is set with the numerical input dialog **【NUM】** .
- [DIRECT EDIT] : The tolerance is edited with the numerical input dialog **【NUM】** .

■ [Amplitude Compression] – [RETRY TIMES] : Set the maximum number of retries.

This sets the maximum number of times that the measurement for adjusting the amplitude is retried. Adjustment of the amplitude is stopped upon reaching the number of retries set here, even if the result is not within the tolerance that has been set.

○ Setting method

< Numerical value settings (immediate setting) > , < Numerical value settings (new input) > ,
< Numerical value settings (edit) >

The setting range is 1 to 9,999 and the resolution is 1.

○ Function key functions

- [DIRECT NEW] : Set the maximum number of retries with the numerical input dialog **【NUM】** .
- [DIRECT EDIT] : Edit the maximum number of retries with the numerical input dialog **【NUM】** .

■ [Amplitude Compression] – [CORRECTION FACTOR] : Set the correction factor.

This sets the correction factor (control sensitivity) that is used in amplitude adjustment. Usually, 100% works well, but the stability of control may depend on the system being measured. If instability is observed, reduce the correction factor.

○ Setting method

< Numerical value settings (immediate setting) > , < Numerical value settings (new input) > ,
< Numerical value settings (edit) >

The setting range is 1 to 100% and the resolution is 1%.

○ Function key functions

- [DIRECT NEW] : Set the correction factor with the numerical input dialog 【NUM】 .
- [DIRECT EDIT] : Edit the correction factor with the numerical input dialog 【NUM】 .

3.5.2 Measure dialog

Measure	
INTEGRATION MODE	FIX
INTEGRATION	1 cycle
START DELAY	0 sec
MEAS DELAY	0 sec
d/dt	OFF

- **[INTEGRATION MODE]** : Set the integration mode.

This sets the integration mode. For more information on integration operation, refer to section "4.4 Integration".

- Setting method

< List operations (confirming) >

- **FIX** : Set manual integration.
- **SHORT** : Set automatic integration (short time, high variance).
- **MED** : Set automatic integration (medium time, medium variance).
- **LONG** : Set automatic integration (long time, low variance).

- **[INTEGRATION]** : Set the integration count or time.

This sets the number of times (or the duration) for manual integration. Increasing this value results in lower noise and cleaner measurement results, but longer measurement time. For information on the integration operation, refer to "4.4 Integration".

- Setting method

< Numerical value settings (immediate setting) > , < Numerical value settings (new input) > ,
< Numerical value settings (edit) >

For number of times, the setting range is 1 to 9,999 cycles and the resolution is one cycle. For duration, the setting is 0 to 9,990 seconds and the resolution is 3 digits or 0.1 ms, whichever is greater.

Integration is always performed for at least one cycle of the signal, even if the set value is 0 seconds.

- Function key functions

- **[DIRECT NEW]**: Set integration with the numerical input dialog **[NUM]** .
- **[DIRECT EDIT]**: Edit integration with the numerical input dialog **[NUM]** .

- Functions of the function keys set with the numerical input dialog **[NUM]**

- **[CYCLE]** : Set the entered value in units of cycle.
- **[msec]** : Set the entered value in units of milliseconds.
- **[sec]** : Set the entered value in units of seconds.

■ [START DELAY] : Set the delay for starting measurement.

This sets the delay time (or number of cycles) for the beginning of a sweep measurement or a spot measurement. This is set for cases in which a large change in frequency generates a transient response in the circuit under test. For information on delays, refer to "5.2 Delay".

○ Setting method

< Numerical value settings (immediate setting) > , < Numerical value settings (new input) > ,
< Numerical value settings (edit) >

For time, the setting range is 0 to 9,990 seconds and the resolution is 3 digits or 0.1 ms, whichever is larger. For cycles, the range is 0 to 9,999 cycles and the resolution is one cycle.

○ Function key functions

- [DIRECT NEW] : Set the start delay with the numerical input dialog **【NUM】** .
- [DIRECT EDIT] : Edit the start delay with the numerical input dialog **【NUM】** .

○ Functions of the function keys set with the numerical input dialog **【NUM】**

- [CYCLE] : Set the entered value in units of cycle.
- [msec] : Set the entered value in units of milliseconds.
- [sec] : Set the entered value in units of seconds.

■ [MEAS DELAY] : Set the delay for measurement.

This sets the delay time (or cycles) for the beginning of a sweep measurement after a frequency change occurs during a sweep. This is set for measurement of circuits that have sudden changes in frequency. For information on delays, refer to "5.2 Delay".

○ Setting method

< Numerical value settings (immediate setting) > , < Numerical value settings (new input) > ,
< Numerical value settings (edit) >

For time, the setting range is 0 to 9,990 seconds and the resolution is 3 digits or 0.1 ms, whichever is larger. For cycles, the range is 0 to 9,999 cycles and the resolution is one cycle.

○ Function key functions

- [DIRECT NEW] : Set the measurement delay with the numerical input dialog **【NUM】** .
- [DIRECT EDIT] : Edit the measurement delay with the numerical input dialog **【NUM】** .

○ Functions of the function keys set with the numerical input dialog **【NUM】**

- [CYCLE] : Set the entered value in units of cycles.
- [msec] : Set the entered value in units of milliseconds.
- [sec] : Set the entered value in units of seconds.

■ [SLOPE COMPENSATION] : Set the potential slope elimination function

This function is used for measuring electrochemical impedance, etc. Normally, this function should be turned off when using the instrument. For more information, refer to "5.9.2 Potential slope elimination function".

○ Setting method

< List operations (confirming) >

- OFF : Turn the potential slope elimination function off.
- ON : Turn the potential slope elimination function on.

■ [d/dt] : Set the integration and differentiation calculation

This function performs calculations on the signals from an acceleration sensor or laser Doppler "5.10 Differentiation and integration function".

○ Setting method

< List operations (confirming) >

- OFF : No calculations are performed.
- $(j\omega)$: The first derivative is calculated.
- $(j\omega)^2$: The second derivative is calculated.
- $(1/j\omega)$: The integral is calculated.
- $(1/j\omega)^2$: The double integral is calculated.

3.5.3 Sweep dialog

Sweep	
SEQ SWEEP	OFF
SWEEP LOWER	10 Hz
SWEEP UPPER	100 kHz
SWEEP RESOLUTION	100 Log steps
REPEAT	OFF
FREQUENCY CHANGE MODE	ASYN
SLOW SWEEP	OFF
CHANNEL	CH1
TYPE	θ
VARIATION	10 deg

■ [SEQ SWEEP] : Set sequence measurement.

This function performs measurements in the order set in the setting memory of the instrument. It is possible to do measurements at different signal levels for each frequency range. For more information in sequence measurements, refer to "5.11 Sequence measurement".

○ Setting method

< List operations (confirming) >

- OFF, 1 to 20 : No sequence measurements, or 1 to 20

■ [SWEEP LOWER] / [SWEEP UPPER] : Set the upper and lower sweep frequencies.

This sets the frequency range for performing sweep measurements.

○ Setting method

< Numerical value settings (immediate setting) >, < Numerical value settings (new input) >, < Numerical value settings (edit) >

The setting range is from 10 μ Hz to 15 MHz and the resolution is 10 μ Hz. The lower frequency limit must be less than the upper frequency limit.

○ Function key functions

- [MKR -> SWEEP] : Set the frequency of the main marker and the delta marker to the range of the sweep frequency.
- [GRAPH -> SWEEP] : Set the sweep frequency range to the range of the X axis (frequency range) of the graph.
- [MKR -> FREQ] : Copy the main marker frequency to the sweep lower frequency limit (for [SWEEP LOWER]) or to the upper frequency limit (for [SWEEP UPPER]).
- [DIRECT NEW] : Set the frequency with the numerical input dialog **[NUM]** .
- [DIRECT EDIT] : Edit the frequency setting with the numerical input dialog **[NUM]** .

○ Functions of the function keys set with the numerical input dialog **[NUM]**

- [μ Hz] : Set with the entered value in units of μ Hz.
- [mHz] : Set with the entered value in units of mHz.
- [Hz] : Set with the entered value in units of Hz.
- [kHz] : Set with the entered value in units of kHz.
- [MHz] : Set with the entered value in units of MHz.

■ [SWEEP RESOLUTION] : Set the sweep resolution.

This sets the resolution of the sweep frequency. The number of data points obtained in a sweep measurement is the resolution value set here +1.

○ Setting method

< Numerical value settings (immediate setting) > , < Numerical value settings (new input) > ,
< Numerical value settings (edit) >

The setting range is from 3 to 20,000 and the resolution is 1. It is possible to select between linear sweep (common difference) and log sweep (common ratio).

○ Function key functions

- [DIRECT NEW] : Set the sweep resolution with the numerical input dialog **【NUM】** .
- [DIRECT EDIT] : Edit the sweep resolution setting with the numerical input dialog **【NUM】** .
- Functions of the function keys set with the numerical input dialog **【NUM】**
 - [Log steps/sweep] : Set the entered value as the log sweep resolution.
 - [Lin steps/sweep] : Set the entered value as the linear sweep resolution.

■ [REPEAT] : Set the repeat mode.

If repeat is on, the measurement is repeated. For sweep measurement, the sweep measurement is started again at the initial frequency. The measurement is repeated until the **STOP** key is pressed. If repeat is off, the measurement is performed one time and then stopped.

○ Setting method

< List operations (confirming) >

- OFF : Repeat off
- ON : Repeat on

■ [FREQUENCY CHANGE MODE] : Set the frequency change phase.

This selects whether to change the frequency immediately or to wait until the 0° phase of a sine function to change the frequency. When performing electrochemical impedance measurements, etc., the area of the plus side and the area of the minus side of an AC sinusoidal signal are the same, so the total charge transfer to the DUT can be made to be zero.

○ Setting method

< List operations (confirming) >

- ASYNC : The frequency is changed instantaneously.
- SYNC : The frequency is not changed until the 0° phase.

When the setting is **SYNC**, it takes up to one cycle of the signal at the longest until the frequency is changed (including when a sweep is in progress). Please note that, the maximum length takes up to 10⁵ seconds (27.8 hours) at the longest for a frequency of 10 μHz.

- [SLOW SWEEP] : Set whether the automatic high density sweep is enabled or disabled.

This sets whether or not the automatic high density sweep is to be performed. For more information on the automatic high density sweep, refer to "5.8 Automatic high density sweep".

- Setting method

< List operations (confirming) >

- OFF : The automatic high density sweep function is disabled.
- ON : The automatic high density sweep function is enabled.

Even if the setting is OFF, the parameters related to the automatic high density sweep are not changed.

- [SLOW SWEEP] – [CHANNEL] : Select the channel for monitoring sudden change.

When performing an automatic density sweep, this sets the channel to monitor for sudden change in characteristic.

- Setting method

< List operations (confirming) >

- CH1 : The reference channel is CH1.
- CH2 : The reference channel is CH2.

- [SLOW SWEEP] – [TYPE] : Select the monitoring parameter type.

When performing an automatic density sweep, this sets a parameter type to monitor for sudden change in characteristic.

- Setting method

< List operations (confirming) >

- dBR : Monitor sudden change in the inter-channel ratio (dB).
- R : Monitor sudden change in the monitored channel amplitude (Vrms).
- θ : Monitor sudden change in the inter-channel phase difference (deg).
- a : Monitor sudden change in real part of the monitored channel amplitude (Vrms).
- b : Monitor sudden change in the imaginary part of the monitored channel amplitude (Vrms).

- [SLOW SWEEP] – [VARIATION] : Set the threshold value for the amount of change.

This sets the threshold value for the amount of parameter change that is regarded as a sudden change. The value stored internally for each parameter type that is set by [TYPE].

- Setting method

< Numerical value settings (immediate setting) > , < Numerical value settings (new input) > ,
< Numerical value settings (edit) >

- Function key functions

- [DIRECT NEW] : Set the threshold with the numerical input dialog **【NUM】** .
- [DIRECT EDIT] : Edit the threshold setting with the numerical input dialog **【NUM】** .

- Functions of the function keys set with the numerical input dialog **【NUM】**

- [u(10^{-6})] : Set with the entered value in units of 10^{-6} .
- [m(10^{-3})] : Set with the entered value in units of 10^{-3} .
- [×1] : Set with the entered value.

The setting range and resolution vary with the type of parameter.

TYPE = dBR : The setting range is from 0 to 1000 dB and the resolution is 0.01 dB.

θ : The setting range is from 0 to 180° and the resolution is 0.01°

R, a, b : The setting range is from 0 to 600 Vrms and the resolution is 3 digits or 1 μV, whichever is greater.

3.5.4 Graph dialog

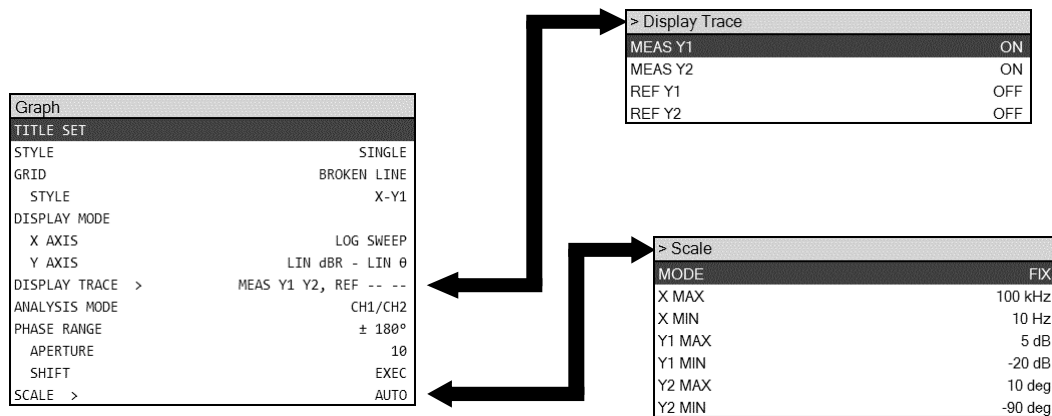

■ [TITLE SET] : Set the graph title.

This sets the title of the graph.f

○ Setting method

< Text settings (confirming) > , < Text settings (new input) > , < Text settings (edit) >

Up to 63 characters can be input.

○ Function key functions

- [DIRECT NEW] : Set the title with the text input dialog **[TEXT]** .
- [DIRECT EDIT] : Edit the title with the text input dialog **[TEXT]** .

■ [STYLE] : Set the graph layout style.

This selects the layout style of the graph for displaying the measurement data.

○ Setting method

< List operations (confirming) >

- SINGLE : Display a single graph
- SPLIT : Display two graphs above and below.

■ [GRID] : Set the gridlines

This sets the style of the gridlines on the graph.

○ Setting method

< List operations (confirming) >

- OFF : No grid
- SOLID LINE : Solid gridlines
- BROKEN LINE : Broken gridlines

■ [GRID] – [STYLE] : Set which gridlines are displayed.

This sets the graph axes for which gridlines are displayed.

○ Setting method

< List operations (confirming) >

- X : Display grid for x-axis only.
- X-Y1 : Display grid for x-axis and Y1 axis.
- X-Y2 : Display grid for x-axis and Y2 axis.
- X-Y1-Y2 : Display grid for x-axis, Y1 axis, and Y2 axis.

■ [DISPLAY MODE] – [X AXIS] : Set the X axis format.

This sets the display mode of the X axis.

○ Setting method

< List operations (confirming) >

There are some formats that cannot be selected, depending on the data type of the Y axis. For more information, refer to "5.5 Graph display".

When the [DISPLAY UNIT] is GAIN

- SWEEP : The X axis is frequency.
- θ : The X axis is phase.
- a : The X axis is the real part of the gain

When the [DISPLAY UNIT] is IMPEDANCE

- SWEEP : The X axis is frequency.
- R : The X axis is resistance.
- G : The X axis is conductance.

○ Function key functions

- [X LOG] : The X axis has a logarithmic scale.
- [X LIN] : The X axis has a linear scale.

■ [DISPLAY MODE] – [Y AXIS] : Set the formats of the Y1 and Y2 axes

This sets the formats for the Y1 and Y2 axes.

○ Setting method

< List operations (confirming) >

There are some formats that cannot be selected, depending on the data type of the Y axis. For more information, refer to "4.6 Graph display mode".

When the [DISPLAY UNIT] is GAIN

- R – θ : The Y1 axis is gain (unitless number), the Y2 axis is phase ($^{\circ}$).
- dBR – θ : The Y1 axis is gain (dB), the Y2 axis is phase ($^{\circ}$).
- R – GD : The Y1 axis is gain (unitless number), the Y2 axis is group delay (sec).
- dBR – GD : The Y1 axis is gain (dB), the Y2 axis is group delay (sec).
- a – b : The Y1 axis is the real part of the gain (unitless number), the Y2 axis is the imaginary part of the gain (unitless number).
- R : The Y1 axis is gain (unitless number), the Y2 axis is nothing.
- dBR : The Y1 axis is gain (dB), the Y2 axis is nothing.
- b : The Y1 axis is the imaginary part of the gain (unitless number), the Y2 axis is nothing.

When the [DISPLAY UNIT] is IMPEDANCE

- Z – θ_z : The Y1 axis is impedance (Ω), the Y2 axis is phase ($^{\circ}$) of impedance.
- Y – θ_y : The Y1 axis is admittance(S), the Y2 axis is phase ($^{\circ}$) of admittance.
- R – X : The Y1 axis is resistance (Ω), the Y2 axis is reactance (Ω).
- G – B : The Y1 axis is conductance(S), the Y2 axis is susceptance (S).
- C_p – R_p : The Y1 axis is parallel capacitance (F), the Y2 axis is parallel resistance (Ω).
- C_p – D : The Y1 axis is parallel capacitance (F), the Y2 axis is dissipation factor (unitless number).
- C_p – Q_c : The Y1 axis is parallel capacitance (F), the Y2 axis is quality factor (unitless number).
- C_s – R_s : The Y1 axis is series capacitance (F), the Y2 axis is series resistance (Ω).
- C_s – D : The Y1 axis is series capacitance (F), the Y2 axis is dissipation factor (unitless number).
- C_s – Q_c : The Y1 axis is series capacitance (F), the Y2 axis is quality factor (unitless number).
- L_p – R_p : The Y1 axis is parallel inductance (H), the Y2 axis is parallel resistance (Ω).
- L_p – Q_L : The Y1 axis is parallel inductance (H), the Y2 axis is quality factor (unitless number).
- L_s – R_s : The Y1 axis is series inductance (H), the Y2 axis is series resistance (Ω).
- V : The Y1 axis is voltage (V_{rms}), the Y2 axis is nothing.
- I : The Y1 axis is current (A_{rms}), the Y2 axis is nothing.

- X : The Y1 axis is reactance (Ω), the Y2 axis is nothing.
- -X : The Y1 axis is reactance (Ω) with top and bottom inverted, the Y2 axis is nothing.
The upward direction of the Y-axis is negative, the downward direction is positive.
- B : Y1 axis is susceptance (S), the Y2 axis (nothing).
- -B : The Y1 axis is susceptance(S) with top and bottom inverted, the Y2 axis (nothing).
The upward direction of the Y-axis is negative, the downward direction is positive.

○ Function key functions

- [Y1 LOG] : The Y1 axis is a logarithmic axis.
- [Y1 LIN] : The Y1 axis is a linear axis.
- [Y2 LOG] : The Y2 axis is a logarithmic axis.
- [Y2 LIN] : The Y2 axis is a linear axis.

■ [DISPLAY UNIT] : Select the measurement item.

This selects whether to perform a gain-phase measurement or an impedance measurement. The graph types and error correction functions that can be set depend on this selection result.

○ Setting method

< List operations (confirming) >

- GAIN : Measure gain-phase
- IMPEDANCE : Measure impedance

■ [DISPLAY TRACE] – [MEAS Y1] : Sets the measurement data display to the Y1 axis.

■ [DISPLAY TRACE] – [MEAS Y2] : Sets the measurement data display to the Y2 axis.

■ [DISPLAY TRACE] – [REF Y1] : Sets the reference data display to the Y1 axis.

■ [DISPLAY TRACE] – [REF Y2] : Sets the reference data display to the Y2 axis.

This selects the data that is to be displayed on the graph.

○ Setting method

< List operations (confirming) >

- ON: The data is displayed.
- OFF: The data is not displayed.

For more information on the graph display trace, refer to "5.5 Graph display".

■ [ANALYSIS MODE] : Set the analysis mode.

This sets the analysis processing method (analysis mode) for the measurement data.

○ Setting method

< List operations (confirming) >

- CH1/CH2 : Analyze the CH1 measurement data (ratio) with the CH2 measurement data as the reference.
- CH2/CH1 : Analyze the CH2 measurement data (ratio) with the CH1 measurement data as the reference.
- CH1 : Use the CH1 measurement data (amplitude) as it is. The phase is insignificant.
- CH2 : Use the CH1 measurement data (amplitude) as it is. The phase is insignificant.

For more information on the analysis mode, refer to "5.1 Analysis mode".

■ [PHASE RANGE] : Set the phase display range.

This sets the display range for the phase.

○ Setting method

< List operations (confirming) >

- $\pm 180^\circ$: Display phase in the range $-180^\circ \leq \theta < +180^\circ$.
- 0 to $+360^\circ$: Display phase in the range $0 \leq \theta < +360^\circ$.
- -360 to 0° : Display phase in the range $-360 \leq \theta < 0^\circ$.
- UNWRAP : Phase unwrapping mode.

■ [PHASE RANGE] – [APERTURE] : Set the number of data items (aperture) for the moving average.

This sets the number of moving average phase data points (number of frequency measurements) for obtaining the group delay characteristic. Although this affects the display of the group delay, it does not affect the display of phase. The group delay characteristic is smoother when the aperture is increased, but sudden changes are not observed.

○ Setting method

< Numerical value settings (immediate setting) > , < Numerical value settings (new input) > ,
< Numerical value settings (edit) >

The setting range is the even values from 2 to 200 and the setting resolution is 2.

○ Function key functions

- [DIRECT NEW] : Set the aperture using the numerical input dialog **[NUM]** .
- [DIRECT EDIT] : Edit the aperture using the numerical input dialog **[NUM]** .

- [PHASE RANGE] – [SHIFT] : The phase display $+360^\circ$ or -360° .

The phase measurement data is displayed with 360° added or subtracted. The setting is effective only when UNWRAP is set for the phase display range; for any other setting, there is no change.

- Function key functions

- [+360°] : Display the phase with 360° added.
- [-360°] : Display the phase with 360° subtracted.

- [SCALE] : Set the graph axis scale

This sets the range for the X, Y1, and Y2 axes.

- [Scale] – [MODE] : Select fixed or automatic.

This selects the method for setting the graph axis range.

- Setting method

< List operations (confirming) >

- AUTO : The axis range is automatically determined so that all of the data is displayed.
- FIX : The graph axis range is fixed and set manually.

- **【Scale】** – [X MAX] : X axis maximum value
- **【Scale】** – [X MIN] : X axis minimum value
- **【Scale】** – [Y1 MAX] : Y1 axis maximum value
- **【Scale】** – [Y1 MIN] : Y1 axis minimum value
- **【Scale】** – [Y2 MAX] : Y2 axis maximum value
- **【Scale】** – [Y2 MIN] : Y2 axis minimum value

The range for each axis is set.

○ Setting method

< Numerical value settings (immediate setting) > , < Numerical value settings (new input) > ,
< Numerical value settings (edit) >

○ Function key functions

- [DATA-> SCALE] : Set the range of the X, Y1, and Y2 according to the data.
- [X DATA-> SCALE] : Set the range of the X axis according to the data.
- [X DATA MIN-> SCALE] : Set the minimum value of the X axis according to the data.
- [X DATA MAX-> SCALE] : Set the maximum value of the X axis according to the data.
- [Y1 DATA-> SCALE] : Set the range of the Y1 axis according to the data.
- [Y1 DATA MIN-> SCALE] : Set the minimum value of the Y1 axis according to the data.
- [Y1 DATA MAX-> SCALE] : Set the maximum value of the Y1 axis according to the data.
- [Y2 DATA-> SCALE] : Set the range of the Y2 axis according to the data.
- [Y2 DATA MIN-> SCALE] : Set the minimum value of the Y2 axis according to the data.
- [Y2 DATA MAX-> SCALE] : Set the maximum value of the Y2 axis according to the data.
- [DIRECT NEW] : Set the maximum value or minimum value of the X axis with the numerical input dialog **【NUM】** .
- [DIRECT EDIT] : Edit the maximum value or minimum value of the X axis with the numerical input dialog **【NUM】** .

○ Functions of the function keys set with the numerical input dialog **【NUM】**

- [u(10^{-6})] : Set the entered value in units of 10^{-6} .
- [m(10^{-3})] : Set the entered value in units of 10^{-3} .
- [×1] : Set the entered value.
- [k(10^3)] : Set the entered value in units of 10^3 .
- [M(10^6)] : Set the entered value in units of 10^6 .
- [f(10^{-15})] : Set the entered value in units of 10^{-15} .
- [p(10^{-12})] : Set the entered value in units of 10^{-12} .
- [n(10^{-9})] : Set the entered value in units of 10^{-9} .
- [G(10^9)] : Set the entered value in units of 10^9 .
- [T(10^{12})] : Set the entered value in units of 10^{12} .

The setting range is from -1.0 T to $+1.0 \text{ T}$ (10^{12}) and the resolution is 6 digits or 1 f (10^{-15}), whichever is larger. For frequency, however, the range is from 10 μHz to 15 MHz.

3.5.5 Marker dialog

Marker	
MARKER	MAIN
SEARCH VALUE	
X	100.000 E-02
Y1	100.000 E-02
Y2	100.000 E-02
ΔX	100.000 E-02
ΔY1	100.000 E-02
ΔY2	100.000 E-02
SEARCH X	EXEC
SEARCH Y1	EXEC
SEARCH Y2	EXEC
AUTO SEARCH	OFF

- [MARKER] : Set the marker display.

Set the marker type that is to be displayed.

- Setting method

< List operations (confirming) >

- OFF : No marker is displayed.
- MAIN : The main marker is displayed.
- MAIN&Δ : The main marker and the delta marker are both displayed.

- [SEARCH VALUE] – [X] : X search value
- [SEARCH VALUE] – [Y1] : Y1 search value
- [SEARCH VALUE] – [Y2] : Y2 search value
- [SEARCH VALUE] – [Δ X] : Δ X search value
- [SEARCH VALUE] – [Δ Y1] : Δ Y1 search value
- [SEARCH VALUE] – [Δ Y2] : Δ Y2 search value

This sets the value to be searched by marker.

○ Setting method

< Numerical value settings (immediate setting) > , < Numerical value settings (new input) > ,
< Numerical value settings (edit) >

○ Function key functions

- [DIRECT NEW] : Set the maximum value or minimum value of the X axis with the numerical input dialog **【NUM】** .
- [DIRECT EDIT] : Edit the maximum value or minimum value of the X axis with the numerical input dialog **【NUM】** .

○ Functions of the function keys set with the numerical input dialog **【NUM】**

- [u(10^{-6})] : Set the entered value in units of 10^{-6} .
- [m(10^{-3})] : Set the entered value in units of 10^{-3} .
- [$\times 1$] : Set the entered value.
- [k(10^3)] : Set the entered value in units of 10^3 .
- [M(10^6)] : Set the entered value in units of 10^6 .
- [f(10^{-15})] : Set the entered value in units of 10^{-15} .
- [p(10^{-12})] : Set the entered value in units of 10^{-12} .
- [n(10^{-9})] : Set the entered value in units of 10^{-9} .
- [G(10^9)] : Set the entered value in units of 10^9 .
- [T(10^{12})] : Set the entered value in units of 10^{12} .

The setting range is -1.0 T to $+1.0 \text{ T}$ (10^{12}) and the resolution is 6 digits or 1 f (10^{-15}), whichever is larger. When the search is for frequency, the range for the main marker is from $10 \mu\text{Hz}$ to 15 MHz and the resolution is $10 \mu\text{Hz}$. For the frequency delta marker, the range is from $-14.999,999,999,990 \text{ MHz}$ ($-15 \text{ MHz} + 10 \mu\text{Hz}$) to $+14.999,999,999,990 \text{ MHz}$ ($15 \text{ MHz} - 10 \mu\text{Hz}$) and the resolution is $10 \mu\text{Hz}$.

- [SEARCH X] : X axis search
- [SEARCH Y1] : Y1 axis search
- [SEARCH Y2] : Y2 axis search

Marker search is performed. The search method is selected by using the function keys. Tapping on a function key begins the search and the marker is moved to the data position that results from the search. For more information on marker operations and search, refer to "5.6 Marker operations".

○ Function key functions([SEARCH X])

- [X MIN] : Move the marker to the position at which the X value is the minimum.
- [X MAX] : Move the marker to the the position at which the X value is the maximum.
- [X] : Move the marker to the position of the X value specified by [SEARCH VALUE] – [X]. If there are multiple Y values, the minimum Y value is chosen.
- [PREV X] : Move the marker to the position of the previous (one smaller) Y value. Others are the same as [X].
- [NEXT X] : Move the marker to the position of the next (one larger) Y value. Others are the same as [X].
- [Δ X] : Move the marker to the position where the delta marker is the value set by [SEARCH VALUE] – [Δ X]. If there are multiple Y values, the minimum Y value is chosen.
- [PREV Δ X] : Move the marker to the position of the previous (one smaller) Y value. Others are the same as [Δ X].
- [NEXT Δ X] : Move the marker to the position of the next (one larger) Y value. Others are the same as [Δ X].
- [X BOTTOM] : Move the marker to the position at which the X value is minimal. If there are multiple X values, the minimum X value is chosen.
- [PREV X BOTTOM] : Move the marker to the position of the previous (one smaller) X value. Others are the same as [X BOTTOM].
- [NEXT X BOTTOM] : Move the marker to the position of the next (one larger) X value. Others are the same as [X BOTTOM].
- [X PEAK] : Move the marker to the position at which the X value is maximal. If there are multiple X values, the maximum X value is chosen.
- [PREV X PEAK] : Move the marker to the position of the previous (one larger) X value. Others are the same as [X PEAK].
- [NEXT X PEAK] : Move the marker to the position of the next (one smaller) X value. Others are the same as [X PEAK].

○ Function key functions ([SEARCH Y1])

- [Y1 MIN] : Move the marker to the position at which the Y1 value is the minimum.
- [Y1 MAX] : Move the marker to the position at which the Y1 value is the maximum.

- [Y1] : Move the marker to the position of the Y1 value specified by [SEARCH VALUE] – [Y1]. If there are multiple X values, the minimum X value is chosen.
- [PREV Y1] : Move the marker to the position of the previous (one smaller) X value. Others are the same as [Y1].
- [NEXT Y1] : Move the marker to the position of the next (one larger) X value. Others are the same as [Y1].
- [Δ Y1] : Move the marker to the position where the delta marker is the value set by [SEARCH VALUE] – [Δ Y1]. If there are multiple X values, the minimum X value is chosen.
- [PREV Δ Y1] : Move the marker to the position of the previous (one smaller) X value. Others are the same as [Δ Y1].
- [NEXT Δ Y1] : Move the marker to the position of the next (one larger) X value. Others are the same as [Δ Y1].
- [Y1 BOTTOM] : Move the marker to the position at which the Y1 value is minimal. If there are multiple Y1 values, the minimum Y1 value is chosen.
- [PREV Y1 BOTTOM] : Move the marker to the position of the previous (one smaller) Y1 value. Others are the same as [Y1 BOTTOM].
- [NEXT Y1 BOTTOM] : Move the marker to the position of the next (one larger) Y1 value. Others are the same as [Y1 BOTTOM].
- [Y1 PEAK] : Move the marker to the position at which the Y1 value is maximal. If there are multiple Y1 values, the maximum Y1 value is chosen.
- [PREV Y1 PEAK] : Move the marker to the position of the previous (one larger) Y1 value. Others are the same as [Y1 PEAK].
- [NEXT Y1 PEAK] : Move the marker to the position of the next (one smaller) Y1 value. Others are the same as [Y1 PEAK].
- Function key functions ([SEARCH Y2])
 - [Y2 MIN] : Move the marker to the position at which the Y2 value is the minimum.
 - [Y2 MAX] : Move the marker to the position at which the Y2 value is the maximum.
 - [Y2] : Move the marker to the position of the Y2 value specified by [SEARCH VALUE] – [Y2]. If there are multiple X values, the minimum X value is chosen.
 - [PREV Y2] : Move the marker to the position of the previous (one smaller) X value. Others are the same as [Y2].
 - [NEXT Y2] : Move the marker to the position of the next (one larger) X value. Others are the same as [Y2].
 - [Δ Y2] : Move the marker to the position where the delta marker is the value set by [SEARCH VALUE] – [Δ Y2]. If there are multiple X values, the minimum

- X value is chosen.
- [PREV Δ Y2] : Move the marker to the position of the previous (one smaller) X value. Others are the same as [Δ Y2].
 - [NEXT Δ Y2] : Move the marker to the position of the next (one larger) X value. Others are the same as [Δ Y2].
 - [Y2 BOTTOM] : Move the marker to the position at which the Y2 value is minimal. If there are multiple Y2 values, the minimum Y2 value is chosen.
 - [PREV Y2 BOTTOM] : Move the marker to the position of the previous (one smaller) Y2 value. Others are the same as [Y2 BOTTOM].
 - [NEXT Y2 BOTTOM] : Move the marker to the position of the next (one larger) Y2 value. Others are the same as [Y2 BOTTOM].
 - [Y2 PEAK] : Move the marker to the position at which the Y2 value is maximal. If there are multiple Y2 values, the maximum Y2 value is chosen.
 - [PREV Y2 PEAK] : Move the marker to the position of the previous (one larger) Y2 value. Others are the same as [Y2 PEAK].
 - [NEXT Y2 PEAK] : Move the marker to the position of the next (one smaller) Y2 value. Others are the same as [Y2 PEAK].

- [AUTO SEARCH] : Set for automatic search after a sweep is completed.

When a sweep measurement is completed, the marker search can be performed automatically according to the settings setting in [AUTO SEARCH].

- Setting method

< List operations (confirming) >

The parameters listed below can be set. For a description of the search, refer to [SEARCH X], [SEARCH Y1], and [SEARCH Y2].

- OFF : Automatic search is not performed.
- X MAX : Automatically search for the maximum X value.
- X MIN : Automatically search for the smallest minimum X value.
- X PEAK : Automatically search for the largest maximal X value.
- X BOTTOM : Automatically search for the smallest minimal X value.
- Y1 MAX : Automatically search for the maximum Y1 value.
- Y1 MIN : Automatically search for the minimum Y1 value.
- Y1 PEAK : Automatically search for the largest maximal Y1 value.
- Y1 BOTTOM : Automatically search for the smallest minimal Y1 value.
- Y2 MAX : Automatically search for the maximum Y2 value.
- Y2 MIN : Automatically search for the minimum Y2 value.
- Y2 PEAK : Automatically search for the largest maximal Y2 value.
- Y2 BOTTOM : Automatically search for the smallest minimal Y2 value.
- X : Automatically search for the X value.
- Y1 : Automatically search for the Y1 value.
- Y2 : Automatically search for the Y2 value.
- Δ X : Automatically search for the delta X value.
- Δ Y1 : Automatically search for the delta Y1 value.
- Δ Y2 : Automatically search for the delta Y2 value.

3.5.6 Trace dialog

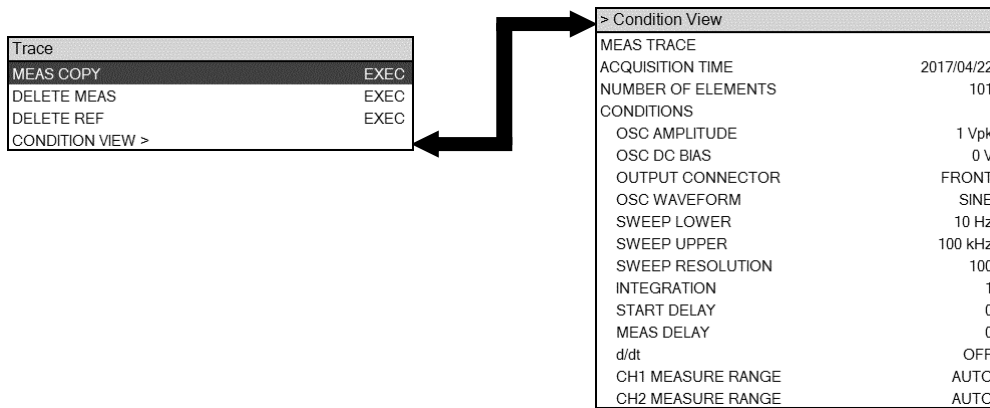

- [MEAS COPY] : Select the location for storing the measurement data.

This copies the measurement data (MEAS DATA). The destination for copying the data is set by tapping a function key.

- Setting method

< Execution operations (immediate) >

- Function key functions

- [REF TRACE] : The data is copied to the reference data (REF DATA).
- [EQUALIZE CORR MEM] : The data is copied to the equalizing data.
- [OPEN CORR MEM] : The data is copied to the open correction data.
- [SHORT CORR MEM] : The data is copied to the short correction data.
- [LOAD CORR MEM] : The data is copied to the load correction data.

For more information on the equalizing, open correction, short correction, and load correction operations, refer to "5.9 Error correction".

- [DELETE MEAS] : Delete the measurement data.

This deletes the measurement data (MEAS DATA) from memory. The graph trace is also erased. The data cannot be recovered after deletion, so save the data to a USB memory device or external storage as necessary.

- Setting method

< Execution operations (immediate) >

- [DELETE REF] : Delete the reference data.

This deletes the reference data (REF DATA) from memory. The graph trace is also erased. The data cannot be recovered after deletion, so save the data to a USB memory device or external storage as necessary.

- Setting method

< Execution operations (immediate) >

- [CONDITION VIEW] : Display the settings at the time of data measurement.

This displays the set conditions (excerpt) at the time the current active data (MEAS DATA or REF DATA) was measured. The display conditions are not the current settings of this instrument.

- Setting method

< Execution operations (immediate) >

For sequence measurement data, the measurement conditions for each measurement memory number are displayed. The measurement conditions for the displayed memory numbers can be changed with the function keys.

- Function key functions

- [PREV] : Display the measurement conditions for the previous memory number.
(enabled for sequence measurement data)
- [NEXT] : Display the measurement conditions for the next memory number.
(enabled for sequence measurement data)

3.5.7 Input dialog

Input	
MEASURE RANGE	
CH1	AUTO
CH2	AUTO
OVER DETECT	
DETECT LEVEL	
CH1	600 Vrms
CH2	600 Vrms
ACTION	
BEEP	OFF
SWEEP STOP	OFF
WEIGHTING FACTOR	
CH1	1.00000 E+00
CH2	1.00000 E+00
INVERT	OFF

■ [MEASURE RANGE] – [CH1] : Set the range for CH1.

■ [MEASURE RANGE] – [CH2] : Set the range for CH2.

This sets the measurement range.

○ Setting method

< List operations (confirming) >

- AUTO : Set the range automatically.
- 30 mV to 600 V : Set a fixed range (30 mVrms to 600 Vrms).

○ Function key functions

- [AUTO] : Set the range automatically.
- [RANGE DOWN] : Set the range one larger.
- [RANGE UP] : Set the range one smaller.

■ [OVER DETECT] – [DETECT LEVEL] – [CH1] : Set the level for CH1 over-level detection.

■ [OVER DETECT] – [DETECT LEVEL] – [CH2] : Set the level for CH2 over-level detection.

○ Setting method

< Numerical value settings (immediate setting) > , < Numerical value settings (new input) > ,
< Numerical value settings (edit) >

○ Function key functions

- [DIRECT NEW] : Set the detection level with the numerical input dialog **[NUM]** .
- [DIRECT EDIT] : Edit the detection level with the numerical input dialog **[NUM]** .

○ Functions of the function keys set with the numerical input dialog **[NUM]**

- [μ Vrms] : Set with the entered value in units of μ Vrms.
- [mVrms] : Set with the entered value in units of mVrms.
- [Vrms] : Set with the entered value in units of Vrms.

The setting range is from 0 μ Vrms to 600 Vrms and the resolution is 3 digits or 1 μ Vrms, whichever is larger.

- [OVER DETECT] – [ACTION] – [BEEP] : Set the beep to sound for over-level detection.

This sets the beep sound to be output when over-level detection occurs.

To make the setting, press the **ENTER** key and make a selection in the listbox by turning the knob or pressing the up and down keys. Fix the selection by pressing the **ENTER** key.

- ON : The beep sounds upon over-level detection.
- OFF : The beep does not sound upon over-level detection.

- [OVER DETECT] – [ACTION] – [SWEEP STOP] : Set the measurement to stop upon over-level detection.

The setting determines whether or not the measurement is to be stopped upon over-level detection.

- Setting method

< List operations (confirming) >

- ON : Measurement stops upon over-level detection.
- OFF : Measurement continues, even upon over-level detection.

If this parameter is set to ON and [OSC] – [ON/OFF SYNC] is set to SYNC, the oscillator output is turned off upon over-level detection.

- [WEIGHTING FACTOR] – [CH1] : Set the CH1 weight factor.
- [WEIGHTING FACTOR] – [CH2] : Set the CH2 weight factor.

This value serves as a multiplier for the measurement result. It can be used as a simple correction factor for when a probe, amplifier, or shunt resistance is connected to the circuit being measured.

- Setting method

< Numerical value settings (immediate setting) > , < Numerical value settings (new input) > ,
< Numerical value settings (edit) >

- Function key functions

- [DIRECT NEW]: Set the weight factor value with the numerical input dialog **【NUM】** .
- [DIRECT EDIT]: Edit the weight factor value with the numerical input dialog **【NUM】** .

- Functions of the function keys set with the numerical input dialog **【NUM】**

- [u(10⁻⁶)] : Set with the entered value in units of 10⁻⁶.
- [m(10⁻³)] : Set with the entered value in units of 10⁻³.
- [×1] : Set with the entered value.
- [k(10³)] : Set with the entered value in units of 10³.
- [M(10⁶)] : Set with the entered value in units of 10⁶.
- [p(10⁻¹²)] : Set with the entered value in units of 10⁻¹².
- [n(10⁻⁹)] : Set with the entered value in units of 10⁻⁹.
- [G(10⁹)] : Set with the entered value in units of 10⁹.
- [T(10¹²)] : Set with the entered value in units of 10¹².

The setting range is 0.0 to 1.0 T (10¹²) and the resolution is 6 digits or 1 p(10⁻¹²), whichever is larger.

- [WEIGHTING FACTOR] – [INVERT] : Set phase inversion.

This inverts the phase of the measurement results.

- Setting method

< List operations (confirming) >

- ON : Display the measurement results with phase inversion.
- OFF : Do not invert phase.

This is set to ON when measuring impedance with the optional "PA-001-0368 IMPEDANCE MEASUREMENT ADAPTER". For more information, refer to "5.9.3 Input weighting".

3.5.8 Storage dialog

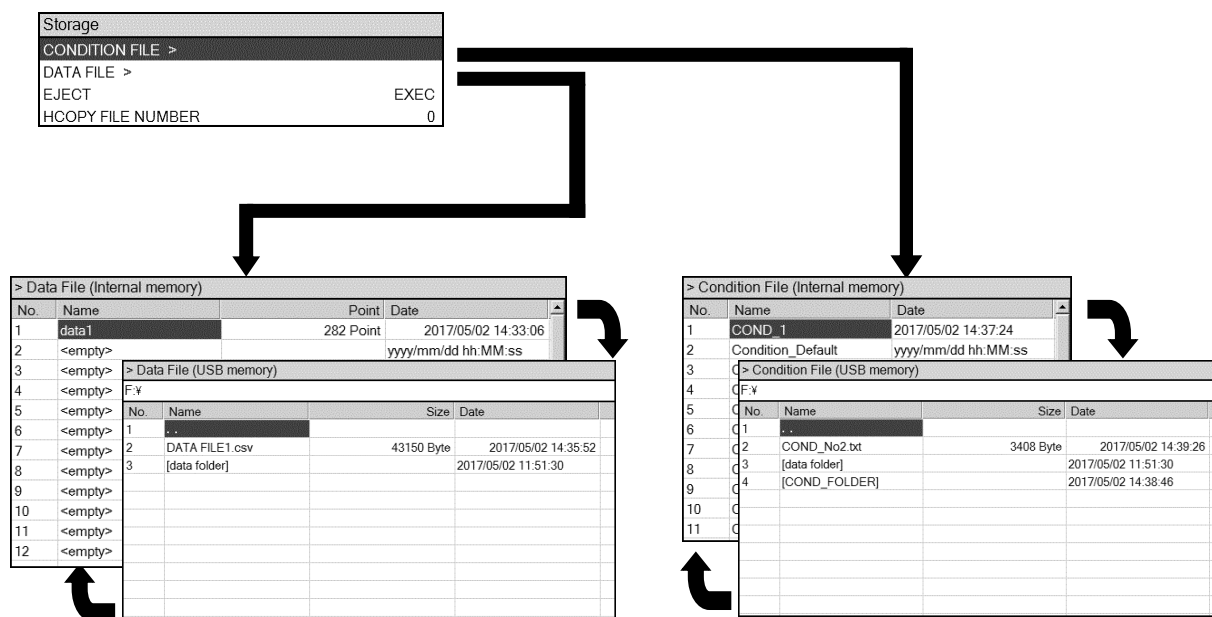

■ [CONDITION FILE] : Measurement condition file operations

These operations include saving and reading the instrument setting information to and from files.

○ Setting method

< Execution operations (immediate) >

Press the **ENTER** key to display a list of measurement condition files (internal memory).

■ 【CONDITION FILE (Internal memory)】 : Measurement conditions file operations (internal memory)

These operations include saving and reading the instrument setting information to and from files that are stored in the internal memory of the instrument.

○ Setting method

< Execution operations (selection) >

○ Function key functions

- [⇒ USB MEM] : Display a list of the files in the USB memory device.
- [SAVE] : Save to internal memory.
- [LOAD] : Read from internal memory.
- [CLEAR] : Delete from internal memory.
- [RENAME] : Change the file name.
- [MOVE UP] : Change positions with the memory above.

In sequence measurement, the measurement is performed by reading from the memories in order beginning with memory number one. To change the order of the measurement conditions for sequence measurement, use the [MOVE UP] function key.

Tapping on the [SAVE] function key displays the text entry dialog **【TEXT】** , where you can enter the file name. After entering the file name, tap on the OK button in the save confirmation message that is displayed to save the file name.

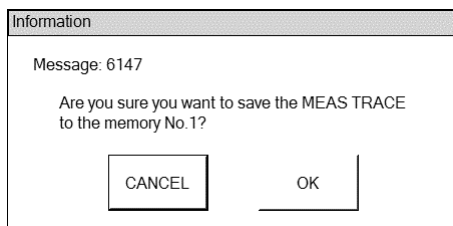

The maximum length of the file name is 20 characters.

For more information on file operations, refer to "5.12 Memory operations".

■ 【CONDITION FILE (USB memory)】 : Measurement conditions file operations (USB memory)

These operations include saving and reading the instrument setting information to and from files that are stored in a USB memory device that is installed in the USB port on the front panel of the instrument.

○ Setting method

< Execution operations (selection) >

○ Function key functions

- [⇒ INT MEM] : Display a list of the files in the internal memory.
- [SAVE] : Save to the USB memory device.
- [LOAD] : Read from the USB memory device.
- [DELETE] : Delete files or folders from the USB memory device.
- [RENAME] : Change a file name.
- [CREATE NEW FOLDER] : Create a new folder.

Tapping on the [SAVE] function key displays the text entry dialog **【TEXT】** , where you can enter the file name. After entering the file name, tap on the OK button in the save confirmation message that is displayed to save the file name.

■ [DATA FILE] : Data file operations

These operations include saving and reading measurement data to and from files, etc.

○ Setting method

< Execution operations (selection) >

Press the **ENTER** key to display a list of measurement condition files (internal memory).

■ **【DATA FILE (Internal memory)】** : Data file operations (internal memory)

These operations include saving and reading measurement data to and from files that are stored in the internal memory of the instrument.

○ Setting method

< Execution operations (selection) >

○ Function key functions

- [⇒ USB MEM] : Display a list of the files in the USB memory device.
- [SAVE] : Save to internal memory.
- [LOAD] : Read from internal memory.
- [CLEAR] : Delete from internal memory.
- [RENAME] : Change the file name.
- [MOVE UP] : Change positions with the memory above.

Tapping on the [SAVE] function key displays the text entry dialog **【TEXT】** , where you can enter the file name. After entering the file name, use the function keys listed below to select where the data is to be saved.

- [MEAS TRACE] : Save the measured data to the internal memory.
- [REF TRACE] : Save the reference data to the internal memory.

If you tap the [LOAD] function key, the function keys listed below are displayed for specifying what is to be loaded.

- [MEAS TRACE] : Load to the measurement data.
- [REF TRACE] : Load to the reference data.
- [EQUALIZE CORR MEM] : Load to the equalizing data.
- [OPEN CORR MEM] : Load to the open correction data.
- [SHORT CORR MEM] : Load to the short correction data.
- [LOAD CORR MEM] : Load to the load correction data.

■ **【DATA FILE (USB memory)】** : Data file operations (USB memory)

These operations include saving and reading data to and from files that are stored in the USB memory device that is installed in the USB port on the front panel of the instrument.

○ Setting method

< Execution operations (selection) >

○ Function key functions

- [⇒ INT MEM] : Display a list of the files in the internal memory.
- [SAVE] : Save to the USB memory device.
- [LOAD] : Read from the USB memory device.
- [DELETE] : Delete files or folders from the USB memory device.
- [RENAME] : Change a file name.

Tapping on the [SAVE] function key displays the text entry dialog **【TEXT】**, where you can enter the file name. After entering the file name, use the function keys listed below to select where the data is to be saved.

- [MEAS TRACE] : Save the measured data to the USB memory device.
- [REF TRACE] : Save the reference data to the USB memory device.

If you tap the [LOAD] function key, the function keys listed below are displayed for specifying what is to be loaded.

- [MEAS TRACE] : Load to the measurement data.
- [REF TRACE] : Load to the reference data.
- [EQUALIZE CORR MEM] : Load to the equalizing data.
- [OPEN CORR MEM] : Load to the open correction data.
- [SHORT CORR MEM] : Load to the short correction data.
- [LOAD CORR MEM] : Load to the load correction data.

■ **[EJECT]** : Eject the USB memory device.

Perform drive unmounting processing so that the USB memory device can be safely removed.

○ Setting method

< Execution operations (selection) >

If you select a menu and press the **ENTER** key, a processing completed message will be displayed. After the message has been displayed, remove the USB memory device.

If you leave the USB device in the port after it has been ejected, it cannot be accessed. Remove the USB device from the port and reinsert it so that the device will be recognized and become available for access.

■ [HCOPY FILE NUMBER] : Set screen image file number.

This sets the serial number of the image file (.bmp) that is to be stored in the USB memory device.

Subsequently, this number is incremented each time an image data file is saved.

○ Setting method

< Numerical value settings (immediate setting) > , < Numerical value settings (new input) > ,
< Numerical value settings (edit) >

The setting range is 000 to 999 and the resolution is 1.

○ Function key functions

- [DIRECT NEW] : Set the file number with the numerical input dialog **【NUM】** .
- [DIRECT EDIT] : Edit the file number setting with the numerical input dialog **【NUM】** .

3.5.9 Remote dialog

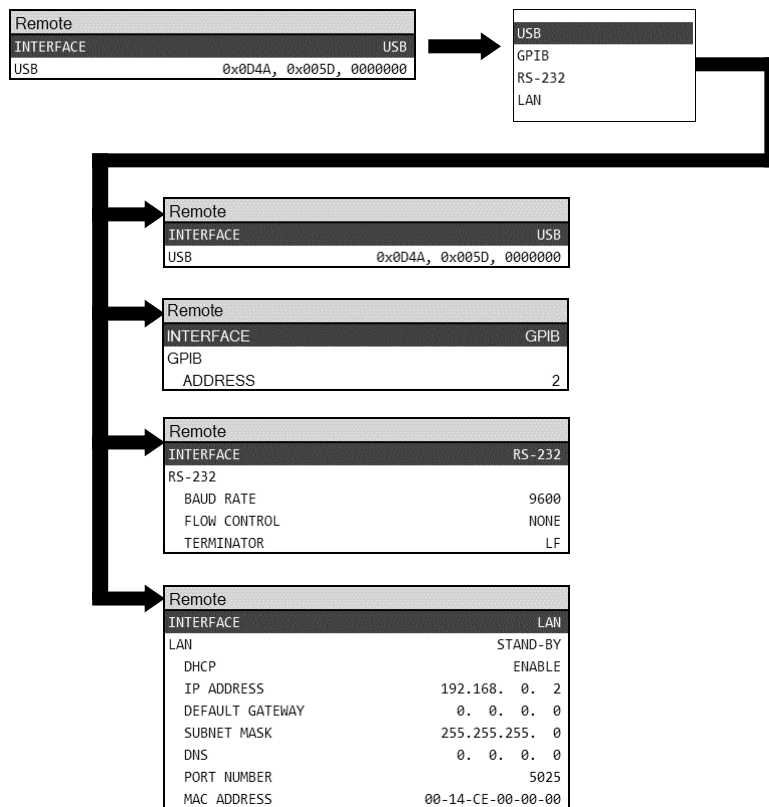

■ Common settings

○ Function key functions

- [INTERFACE APPLY] : Apply the setting change to the hardware.

Even if the remote relationship setting is changed, it will not take effect in the hardware until the [INTERFACE APPLY] function key is pressed.

■ [INTERFACE] : Select the interface.

This sets the communication interface that is to be used.

○ Setting method

< List operations (confirming) >

- USB : Use USBTMC for communication.
- GPIB : Use GPIB for communication.
- RS-232 : Use RS-232 for communication.
- LAN : Use Ethernet for communication.

■ [USB] : Select USB.

There is nothing to set. The vendor ID, product ID, and serial number are displayed.

■ [GPIB] – [ADDRESS] : Set the GPIB address.

This sets the GPIB address.

○ Setting method

< Numerical value settings (immediate setting) > , < Numerical value settings (new input) > ,
< Numerical value settings (edit) >

The setting range is 0 to 30 and the setting resolution is 1.

○ Function key functions

- [DIRECT NEW] : Set the address with the numerical input dialog **[NUM]** .
- [DIRECT EDIT] : Edit the address with the numerical input dialog **[NUM]** .

■ [RS-232] – [BAUD RATE] : Set the RS-232 baud rate.

This sets the baud rate for the RS-232 interface.

○ Setting method

< List operations (confirming) >

- 4800 : 4,800 bps
- 9600 : 9,600 bps
- 19200 : 19,200 bps
- 38400 : 38,400 bps
- 57600 : 57,600 bps
- 115200 : 115,200 bps
- 230400 : 230,400 bps

■ [RS-232] – [FLOW CONTROL] : Set RS-232 flow control.

This sets the flow control for the RS-232 interface.

○ Setting method

< List operations (confirming) >

- NONE : No flow control
- SOFT : Software flow control (Xon, Xoff)
- HARD : Hardware flow control (RTS, CTS)

■ [RS-232] – [TERMINATOR] : Set the RS-232 message terminator.

This sets the terminating character for RS-232 messages.

○ Setting method

< List operations (confirming) >

- CRLF : CR + LF
- LF : LF

- [LAN] – [DHCP] : Select the method for determining the Ethernet IP address.

This sets the method for determining the Ethernet IP address.

- Setting method

- < List operations (confirming) >

- ON : DHCP is enabled
 - OFF : DHCP is disabled (set IP address manually)

- Function key functions

- [LAN RESET] : Initialize settings related to the LAN.

- [LAN] – [IP ADDRESS] : Set the Ethernet IP address.

- [LAN] – [DEFAULT GATEWAY] : Set the Ethernet default gateway.

- [LAN] – [SUBNET MASK] : Set the Ethernet subnet mask.

- [LAN] – [DNS] : Set the Ethernet DNS server.

These settings specify the IP address of the instrument, the default gateway IP address, the DNS server IP address, and the LAN subnet mask.

- Setting method

- < Numerical value settings (immediate setting) > , < Numerical value settings (new input) > ,

- < Numerical value settings (edit) >

The setting range for all octets is from 0 to 255 and the resolution is 1.

- Function key functions

- [DIRECT NEW] : Set the octet with the numerical input dialog **[NUM]** .
 - [DIRECT EDIT] : Edit the octet setting with the numerical input dialog **[NUM]** .
 - [LAN RESET] : Initialize settings related to the LAN.

- [LAN] – [PORT NUMBER] : Display the Ethernet port number.

The port number cannot be changed.

- [LAN] – [MAC ADDRESS] : Display the Ethernet MAC address.

This is the MAC address of the Ethernet connector for this instrument. It cannot be changed.

3.5.10 Calibration dialog

Calibration	
CALIBRATION	EXEC
EQUALIZING	OFF

■ [CALIBRATION] : Execute calibration.

This executes the self-calibration function of the instrument.

○ Setting method

< Execution operations (confirm) >

Selected menu and press the **ENTER** key to display the cable connection confirmation message. After confirming the cable connection, press the **ENTER** key or tap on the [OK] button to start the calibration.

During calibration, a progress dialog box is displayed as shown below. That dialog box closes automatically when the calibration process ends normally.

Calibration	
Calibrating...	
CALcode 3020/18000	

For more information on calibration, refer to "5.9.1 Calibration".

■ [EQUALIZING] : Set the equalization.

This sets the equalizing function to on or off. This setting should not be turned on during impedance measurement.

○ Setting method

< List operations (confirming) >

- ON : Equalizing is enabled.
- OFF : Equalizing is disabled

For more information on equalizing, refer to "5.9.4 Equalizing".

■ [OPEN CORRECTION] : Set the open correction.

This sets the open correction function on or off. This setting should not be turned on during gain / phase measurement.

○ Setting method

< List operations (confirming) >

- ON : Enables open correction.
- OFF : Disables open correction.

For more information on open correction, refer to "5.9.6 Open correction".

■ [SHORT CORRECTION] : Set the short correction.

This sets the short correction function on or off. This setting should not be turned on during gain / phase measurement.

○ Setting method

< List operations (confirming) >

- ON : Enables short correction.
- OFF : Disables short correction.

For more information on short correction, refer to "5.9.7 Short correction".

■ [LOAD CORRECTION] : Set the load correction

This sets the load correction function on or off. This setting should not be turned on during gain / phase measurement.

○ Setting method

< List operations (confirming) >

- ON : Enables load correction.
- OFF : Disables load correction.

If load correction is enabled, the instrument operates with open correction and short correction both forcefully enabled, even if the settings for those two functions are set to disabled.

For more information on load correction, refer to "5.9.8 Load correction".

■ [LOAD CORRECTION]—[LOAD STANDARD FORMAT] : Set the load standard value format

This sets the format for when the load standard value is input.

○ Setting method

< List operations (confirming) >

- Cs-D : Specify with the series capacitance and the dissipation factor.
- Cp-D : Specify with the parallel capacitance and the dissipation factor.
- Rp-Cp : Specify with the parallel resistance and parallel capacitance.
- Rs-Ls : Specify with the series resistance and series inductance.
- Rs-X : Specify with resistance (serial resistance) and reactance.
- Z- θ : Specify with impedance and phase.

For more information on load correction, refer to "5.9.8 Load correction".

- [LOAD CORRECTION]—[LOAD STANDARD VALUE] : Set the load standard value

This sets the load standard value.

When the menu is selected and **ENTER** key is pressed, the **【Load Standard Value】** dialog is displayed.

The frequency and the load standard value for the frequency can be set. Up to 10 sets of load standard values (10 frequencies) can be set.

- [LOAD CORRECTION]—[LOAD STANDARD VALUE]— **【Load Standard Value】**

: Set the load standard value format

This sets the load standard values for the frequencies specified by the load standard format. Up to 10 sets of load standard values can be set (10 frequencies). When the parameter is selected and the front-panel knob is turned clockwise, the setting item changes in the order of No.1 FREQUENCY → No.1 Standard value PRI → No.1 Standard value SEC → No.2 FREQUENCY → No.2 Standard value PRI → No.2 Standard value SEC →....

- Setting method

<numerical value settings (immediate)>, <numerical value settings (new),

<numerical value settings (edit)>

- Function key functions

- [DIRECT NEW] : Set the standard value with the numerical input dialog **【NUM】** .

- [DIRECT EDIT] : Edit the standard value with the numerical input dialog **【NUM】** .

- Functions of the function keys set with the numerical input dialog **【NUM】**

- [u (10^{-6})] : Set with the entered value in units of 10^{-6} .

- [m (10^{-3})] : Set with the entered value in units of 10^{-3} .

- [$\times 1$] : Set with the entered value.

- [k (10^3)] : Set with the entered value in units of 10^3 .

- [M (10^6)] : Set with the entered value in units of 10^6 .

- [p (10^{-12})] : Set with the entered value in units of 10^{-12} .

- [n (10^{-9})] : Set with the entered value in units of 10^{-9} .

- [G (10^9)] : Set with the entered value in units of 10^9 .

- [T (10^{12})] : Set with the entered value in units of 10^{12} .

The setting range is frequencies from 10 μ Hz to 15 MHz and the setting resolution is 10 μ Hz. The resolution for the load standard value is 6 digits or 1 a (10^{-18}), whichever is larger, in the range from -1.0 T to $+1.0$ T.

■ [PORT EXTENSION] : Set the port extension

This turns the port extension correction function on or off. This setting should not be turned on during gain / phase measurement.

○ Setting method

< List operations (confirming) >

- ON : Enables port extension
- OFF : Disables port extension

For more information on port extension, refer to "5.9.6 Port extension".

■ [PORT EXTENSION]—[Z0] : Set the characteristic impedance

Set the characteristic impedance of the line for port extension correction.

○ Setting method

< Numerical value settings (immediate setting) > , < Numerical value settings (new input) > ,
< Numerical value settings (edit) >

○ Function key functions

- [50Ω] : Set the characteristic impedance to 50 Ω.
- [75Ω] : Set the characteristic impedance to 75 Ω.
- [DIRECT NEW] : Set the characteristic impedance with the numerical input dialog **【NUM】** .
- [DIRECT EDIT] : Edit the characteristic impedance with the numerical input dialog **【NUM】** .

The setting range is from 1.00 to 999 Ω and the resolution is 3 digits.

■ [PORT EXTENSION]—[ELECTRICAL LENGTH] : Set the electrical length

Set the electrical length of the line for port extension correction. This is not the physical length. The electrical length is a value that takes into account the wavelength shortening ratio.

○ Setting method

< Numerical value settings (immediate setting) > , < Numerical value settings (new input) > ,
< Numerical value settings (edit) >

○ Function key functions

- [DIRECT NEW] : Set the electrical length of the line with the numerical input dialog **【NUM】** .
- [DIRECT EDIT] : Edit the electrical length of the line with the numerical input dialog **【NUM】** .

The setting range is from 1.00 to 999 Ω and the resolution is 3 digits.

3.5.11 Other dialogs

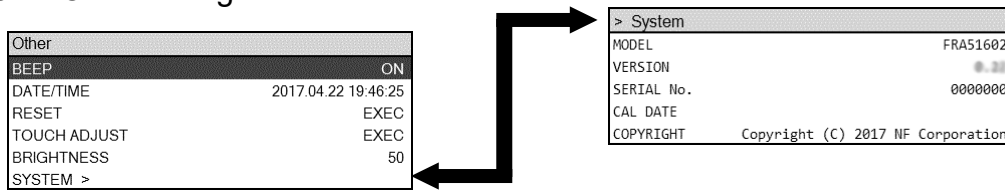

- [BEEP] : Turns the beep sound on or off.

This sets the beep sound (internal buzzer) to on or off.

- Setting method

< List operations (confirming) >

- ON : The beep sound is enabled.
- OFF : The beep sound is disabled.

- [DATE/TIME] : Set the date and time.

This sets the internal calendar and clock.

- Setting method

< Numerical value settings (immediate setting) > , < Numerical value settings (new input) > ,
< Numerical value settings (edit) >

The year, month, and day is displayed in 24-hour format as `yyyymmdd`.

The setting range is from 1998 to 2099 for the year, 1 to 12 for the month, 1 to 31 for the day, 0 to 23 for the hour, 0 to 59 for the minute, and 0 to 59 for the second. The setting resolution is 1 for all items.

- [RESET] : Initialize settings.

The settings of the instrument are initialized.

- Setting method

< Execution operations (confirm) >

Select the menu and press the **ENTER** key to display the confirmation message. Press the **ENTER** key or tap on the [OK] button to initialize the settings.

For more information on the initialization, refer to "3.6 Initial settings".

- [TOUCH ADJUST] : Adjust the touch panel position.

This adjusts the position of the touch panel of the instrument.

- Setting method

< Execution operations (confirm) >

Select the menu and press the **ENTER** key to display the confirmation message. Press the **ENTER** key or tap on the [OK] to display the touch panel position adjustment screen.

For more information on touch panel position adjustment, refer to "5.14.3 Touch panel adjustment".

■ [BRIGHTNESS] : LCD brightness adjustment

This adjust the brightness of the LCD backlight.

○ Setting method

< Numerical value settings (immediate setting) >, < Numerical value settings (new input) >, < Numerical value settings (edit) >

The setting range is from 0 to 100 and the resolution is 1. Higher numerical values mean higher brightness. Even if this value is set to 0, the LCD backlight is not entirely turned off.

■ [SYSTEM] : Display the instrument system information.

This displays the instrument model name and other such information.

Select the menu and then press the **ENTER** key to display the [System] dialog. The dialogue only displays information; no settings can be change. The information that is displayed is shown below.

- MODEL : Model name "FRA51615"
- VERSION : Firmware version
- SERIAL No. : Manufacturing serial number
- CAL DATE : The date of the last instrument calibration
- COPYRIGHT : Copyright information

○ Function key functions

- [FIRMWARE UPDATE] : Update the instrument firmware.
- [TIME ZONE] : Set the time zone.
- [INITIALIZE] : Restore factory settings.

3.5.12 BASIC SETUP dialog

This is displayed when the front panel **BASIC SETUP** key is pressed.

This is a shortcut menu that allows you to easily set items that are frequently set.

Basic Setup	
SWEEP LOWER	10 Hz
SWEEP UPPER	100 kHz
AMPLITUDE	1 Vpk
INTEGRATION	1 cycle

The setting operations are the same for each dialog. They are described below.

■ [SWEEP LOWER] : Sweep lower frequency

→ **[Sweep]** – [SWEEP LOWER]

■ [SWEEP UPPER] : Sweep upper frequency

→ **[Sweep]** – [SWEEP UPPER]

■ [AMPLITUDE] : AC amplitude

→ **[OSC]** – [AMPLITUDE]

■ [INTEGRATION] : Number of integrations or integration time

→ **[Measure]** – [INTEGRATION]

3.6 Initial settings

This instrument is initialized when described below.

- When shipped from factory

All of the settings have the initial values. The content of the setting memory is the same as the initial settings.

- When the reset instruction has been given

All settings other than setting memory, measurement data, and interface settings are initialized.

Panel operation [Other] – [RESET]

Remote control command *RST command

- When power is turned on, if the resume memory storing the last settings has an error.

Refer to "Table 3-1 Initial settings" for the items to be initialized and the initial values. The table also shows whether the parameter values are to be initialized, be saved in the resume memory, be saved as measurement data, or be loaded when sequencing.

Table 3-1 Initial settings 1/8

Setting item	Parameter range	Initial value	Reset	Resume	Save as measurement data	Load when sequencing
<OSC>						
FREQUENCY	10 μ to 15 MHz	1 kHz	Y	Y	Y	Y
AMPLITUDE	0 to 10 V _{pk}	1 V _{pk}	Y	Y	Y	Y
DC BIAS	-10 to +10 V	0 V	Y	Y	Y	Y
OUTPUT CONNECTOR	FRONT REAR	FRONT	Y	Y	Y	Y
ON/OFF SYNC	ASYNC SYNC(AC+DC) SYNC(AC)	ASYNC	Y	Y	N	Y
ON/OFF MODE	QUICK SLOW	QUICK	Y	Y	N	Y
STOP MODE	QUICK 0°SYNC	QUICK	Y	Y	N	Y
WAVEFORM	SINE SQUARE TRIANGLE	SINE	Y	Y	Y	Y
10MHz REF IN	DISABLE ENABLE	DISABLE	Y	Y	N	Y
10MHz REF OUT	DISABLE ENABLE	DISABLE	Y	Y	N	Y

3.6 Initial settings

Table 3-1 Initial settings 2/8

Setting item	Parameter range	Initial value	Reset	Resume	Save as measurement data	Load when sequencing
AMPLITUDE COMPRESSION						
FUNCTION	OFF ON	OFF	Y	Y	N	Y
REF CHANNEL	CH1 CH2	CH1	Y	Y	N	Y
REF LEVEL	1 μ to 600 Vrms	1 Vrms	Y	Y	N	Y
OUTPUT LIMIT	1 m to 10 Vpk	1 Vpk	Y	Y	N	Y
TOLERANCE	1 to 100%	10%	Y	Y	N	Y
RETRY TIMES	1 to 9999	10	Y	Y	N	Y
CORRECTION FACTOR	1 to 100%	100%	Y	Y	N	Y
< Measure >						
INTEGRATION MODE	FIX SHORT MED LONG	FIX	Y	Y	Y	Y
INTEGRATION	UNIT	CYCLE TIME	Y	Y	Y	Y
	CYCLE	1 to 9999 CYCLE	Y	Y	Y	Y
	TIME	0 to 9990 SEC	Y	Y	Y	Y
START DELAY	UNIT	CYCLE TIME	Y	Y	Y	Y
	CYCLE	0 to 9999 CYCLE	Y	Y	Y	Y
	TIME	0 to 9990 SEC	Y	Y	Y	Y
MEAS DELAY	UNIT	CYCLE TIME	Y	Y	Y	Y
	CYCLE	0 to 9999 CYCLE	Y	Y	Y	Y
	TIME	0 to 9990 SEC	Y	Y	Y	Y
SLOPE COMPENSATION	ON OFF	OFF	Y	Y	Y	N
d/dt	OFF (j ω) (j ω) ² (1/j ω) (1/j ω) ²	OFF	Y	Y	Y	Y

3.6 Initial settings

Table 3-1 Initial settings 3/8

Setting item	Parameter range	Initial value	Reset	Resume	Save as measurement data	Load when sequencing
< Sweep >						
SEQ SWEEP	OFF 1 to 20	OFF	Y	Y	N	N
SWEEP LOWER	10 μ to 15 MHz But, < SWEEP UPPER	10 Hz	Y	Y	Y	Y
SWEEP UPPER	10 μ to 15 MHz But, > SWEEP LOWER	100 kHz	Y	Y	Y	Y
SWEEP RESOLUTION	LIN LOG	LOG	Y	Y	Y	Y
	3 to 20000	100	Y	Y	Y	Y
REPEAT	ON OFF	OFF	Y	Y	N	N
FREQUENCY CHANGE MODE	ASYNC 0°SYNC	ASYNC	Y	Y	Y	Y
SLOW SWEEP	ON OFF	OFF	Y	Y	N	Y
CHANNEL	CH1 CH2	CH1	Y	Y	N	Y
TYPE	dBR R θ a b	θ	Y	Y	N	Y
VARIATION	dBR	0 to 1000 dB	Y	Y	N	Y
	R, a, b	0 to 600 Vrms	Y	Y	N	Y
	θ	0 to 180°	Y	Y	N	Y

3.6 Initial settings

Table 3-1 Initial settings 4/8

Setting item	Parameter range	Initial value	Reset	Resume	Save as measurement data	Load when sequencing	
< Graph >							
TITLE SET	Up to 63 characters	(empty)	Y	Y	Y	N	
STYLE	SINGLE SPLIT	SINGLE	Y	Y	N	N	
GRID	SOLID LINE BROKEN LINE	BROKEN LINE	Y	Y	N	N	
STYLE	OFF X X-Y1 X-Y2 X-Y1-Y2	X-Y1	Y	Y	N	N	
DISPLAY MODE							
X AXIS	TYPE	LIN LOG	LOG	Y	Y	N	N
	GAIN	SWEEP θ A	SWEEP	Y	Y	N	N
	IMPEDANCE	SWEEP R G	SWEEP	Y	Y	N	N
Y AXIS	Y1 TYPE	LIN LOG	LIN	Y	Y	N	N
	Y2 TYPE	LIN LOG	LIN	Y	Y	N	N
	GAIN	R- θ dBR- θ R-GD dBR-GD a-b R dBR b	dBR- θ	Y	Y	N	N
	IMPEDANCE	Z- θ_z Y- θ_y R-X G-B C _p -R _p C _p -D C _p -Q _c C _s -R _s C _s -D C _s -Q _c L _p -R _p L _p -Q _L L _s -R _s L _s -Q _L V I X -X B -B	Z- θ_z	Y	Y	N	N
DISPLAY UNIT		GAIN IMPEDANCE	GAIN	Y	Y	Y	N
DISPLAY TRACE	MEAS Y1	ON OFF	ON	Y	Y	N	N
	MEAS Y2	ON OFF	ON	Y	Y	N	N
	REF Y1	ON OFF	OFF	Y	Y	N	N
	REF Y2	ON OFF	OFF	Y	Y	N	N
ANALYSIS MODE		CH1/CH2 CH2/CH1 CH1 CH2	CH1/CH2	Y	Y	N	N
PHASE RANGE		$\pm 180^\circ$ 0 to 360° -360 to 0° UNWRAP	$\pm 180^\circ$	Y	Y	N	N
APERTURE		2 to 200	10	Y	Y	N	N
SCALE	MODE	AUTO FIX	AUTO	Y	Y	N	N
	X MAX	-1.0 T to +1.0 T	100.0 k	Y	Y	N	N
	X MIN	-1.0 T to +1.0 T	10.0	Y	Y	N	N
	Y1 MAX	-1.0 T to +1.0 T	100.0 k	Y	Y	N	N
	Y1 MIN	-1.0 T to +1.0 T	1.0	Y	Y	N	N
	Y2 MAX	-1.0 T to +1.0 T	10.0	Y	Y	N	N
	Y2 MIN	-1.0 T to +1.0 T	1.0	Y	Y	N	N

3.6 Initial settings

Table 3-1 Initial settings 5/8

Setting item	Parameter range	Initial value	Reset	Resume	Save as measurement data	Load when sequencing	
< Marker >							
MARKER	OFF MAIN MAIN&△	MAIN	Y	Y	N	N	
SEARCH VALUE	X	-1.0 T to +1.0 T	1.0	Y	Y	N	N
	Y1	-1.0 T to +1.0 T	1.0	Y	Y	N	N
	Y2	-1.0 T to +1.0 T	1.0	Y	Y	N	N
	△X	-1.0 T to +1.0 T	1.0	Y	Y	N	N
	△Y1	-1.0 T to +1.0 T	1.0	Y	Y	N	N
	△Y2	-1.0 T to +1.0 T	1.0	Y	Y	N	N
AUTO SEARCH	OFF X MAX X MIN X PEAK X BOTTOM Y1 MAX Y1 MIN Y1 PEAK Y1 BOTTOM Y2 MAX Y2 MIN Y2 PEAK Y2 BOTTOM X Y1 Y2 △X △Y1 △Y2	OFF	Y	Y	N	N	
< Trace >							
MEAS DATA	-	-	N	Y	-	-	
REF DATA	-	-	N	Y	-	-	
EQUALIZE CORR MEM	-	-	N	Y	-	-	
OPEN CORR MEM	-	-	N	Y	-	-	
SHORT CORR MEM	-	-	N	Y	-	-	
LOAD CORR MEM	-	-	N	Y	-	-	
(SPOT DATA)	-	-	N	N	-	-	

3.6 Initial settings

Table 3-1 Initial settings 6/8

Setting item	Parameter range	Initial value	Reset	Resume	Save as measurement data	Load when sequencing	
< Input >							
MEASURE RANGE	CH1	AUTO 600 V 300 V 100 V 30 V 10 V 3 V 1 V 300 mV 100 mV 30 mV	AUTO	Y	Y	Y	Y
	CH2	AUTO 600 V 300 V 100 V 30 V 10 V 3 V 1 V 300 mV 100 mV 30 mV	AUTO	Y	Y	Y	Y
OVER DETECT							
DETECT LEVEL	CH1	0 to 600 Vrms	600 Vrms	Y	Y	N	Y
	CH2	0 to 600 Vrms	600 Vrms	Y	Y	N	Y
ACTION	BEEP	ON OFF	OFF	Y	Y	N	N
	SWEEPSTOP	ON OFF	STOP	Y	Y	N	N
WEIGHTING FACTOR	CH1	0.0 to 1.0 T	1.0	Y	Y	N	N
	CH2	0.0 to 1.0 T	1.0	Y	Y	N	N
INVERT	ON OFF	OFF	Y	Y	N	N	
< Storage >							
CONDITIONFILE (1 to 20)	–	–	N	Y	Y*1	Y	
DATA FILE (1 to 20)	–	–	N	Y	N	N	
HCOPY FILE NUMBER	000 to 999	000	N	Y	N	N	

*1: Only typical settings are saved.

3.6 Initial settings

Table 3-1 Initial settings 7/8

Setting item	Parameter range	Initial value	Reset	LAN RESET	Resume	Save as measurement data	Load when sequencing
< Remote >							
SELECT	USB GPIB RS-232 LAN	USB	N	N	Y	N	N
GPIB ADDRESS	0 to 30	2	N	N	Y	N	N
RS-232	BAUD RATE	4800 9600 19200 38400 57600 115200 230400	N	N	Y	N	N
	FLOW CONTROL	NONE SOFT HARD	N	N	Y	N	N
	TERMINATOR	CR+LF LF	N	N	Y	N	N
LAN	IP METHOD	ENABLE DISABLE	N	Y	Y	N	N
	IP ADDRESS	0.0.0.0 to 255.255.255.255	N	Y	Y	N	N
	DEFAULT GATEWAY	0.0.0.0 to 255.255.255.255	N	Y	Y	N	N
	SUBNET MASK	0.0.0.0 to 255.255.255.255	N	Y	Y	N	N
	DNS	0.0.0.0 to 255.255.255.255	N	Y	Y	N	N
	PORT NUMBER		5025	-	-	-	-
	MAC ADDRESS		00-14-CE -XX-XX-XX	-	-	-	-

3.6 Initial settings

Table 3-1 Initial settings 8/8

Setting item	Parameter range	Initial value	Reset	LAN RESET	Resume	Save as measurement data	
< Calibration >							
EQUALIZE	ON OFF	OFF	Y	Y	Y	N	
OPEN CORRECTION	ON OFF	OFF	Y	Y	Y	N	
SHORT CORRECTION	ON OFF	OFF	Y	Y	Y	N	
LOAD CORRECTION	ON OFF	OFF	Y	Y	Y	N	
LOAD STANDARD FORMAT	Cs-D Cp-D Rp-Cp Rs-Ls Rs-X Z-θ	Cs-D	Y	Y	N	N	
LOAD STANDARD VALUE	-1.0 T to +1.0 T	1.0	Y	Y	N	N	
PORT EXTENSION	ON OFF	OFF	Y	Y	Y	N	
ZO	1.00 to 999 Ω	50.0 Ω	Y	Y	N	N	
ELECTRICAL LENGTH	0.000 to 999.999 m	0.000 m	Y	Y	N	N	
< Other >							
BEEP	ON OFF	ON	Y	Y	N	N	
DATE/TIME	YEAR	1998 to 2099	(when shipped)	N	Y	Y	N
	MONTH	1 to 12	(when shipped)	N	Y	Y	N
	DATE	1 to 31	(when shipped)	N	Y	Y	N
	TIME	0 to 23	(when shipped)	N	Y	Y	N
	MINUTE	0 to 59	(when shipped)	N	Y	Y	N
	SEC	0 to 59	(when shipped)	N	Y	Y	N
TOUCH ADJUST	–	–	N	Y	N	N	
BRIGHTNESS	0 to 100	50	N	Y	N	N	

■ Remarks

- Y There is the function
- N There is no function (no influence)
- Not applicable

(Blank)

4. Basic operation

4.1	Display and operation for powering up.....	4-2
4.1.1	What to check before turning the power on	4-2
4.1.2	Turning power on and off	4-2
4.1.3	Restoration of settings at power on	4-3
4.1.4	Startup screen and operation.....	4-4
4.2	Simple operation for the first use	4-5
4.2.1	Common operations	4-5
4.2.2	Measuring loop gain	4-6
4.2.3	Measuring the gain-phase characteristic	4-10
4.2.4	Measuring impedance	4-11
4.3	Oscillator settings.....	4-14
4.4	Integration	4-18
4.5	Measurement control	4-20
4.6	Graph display mode	4-22
4.7	High-frequency measurements	4-27

4.1 Display and operation for powering up

4.1.1 What to check before turning the power on

Before turning the instrument power switch on, read "2.3 Grounding and power connection" and check the instrument grounding and power supply voltage.

4.1.2 Turning power on and off

The instrument has the three operating modes listed below. The operating mode is set by using the power switch (rear panel) and the standby switch (front panel).

Power on	The instrument is operating, has been set up, and a measurement can be performed.
Power off	The instrument is disconnected from the power supply (inoperative)
Standby	Power is supplied to the instrument, but the instrument is inoperative.

The general procedures for turning the power on and off are described below.

■ Turning the power on

Make sure that the power cord is inserted into the power inlet and is plugged into an appropriate power source. Make sure that the power switch is set to the " | " position.

Press the standby switch to turn the power on. The startup screen will be displayed on the LCD and the instrument will then be operational.

■ Setting the instrument to standby state

To set the instrument to standby mode when the instrument is operating (power on), press and hold the standby switch for at least four seconds. The shutdown operation will begin and after about 10 seconds the instrument will be in standby mode (not operational).

■ Turning the power off

When the instrument is in standby mode, perform either or both of the operations listed below.

Set the power switch to the " ○ " position.

Remove the power cord from the power inlet or unplug the power cord from the outlet.

In normal use, it is not necessary for the instrument to be in the power off mode.

4.1.3 Restoration of settings at power on

The settings of the instrument at startup depends on how the power was turned off when the instrument was last used. In any case, however, the oscillator output is always off immediately after startup.

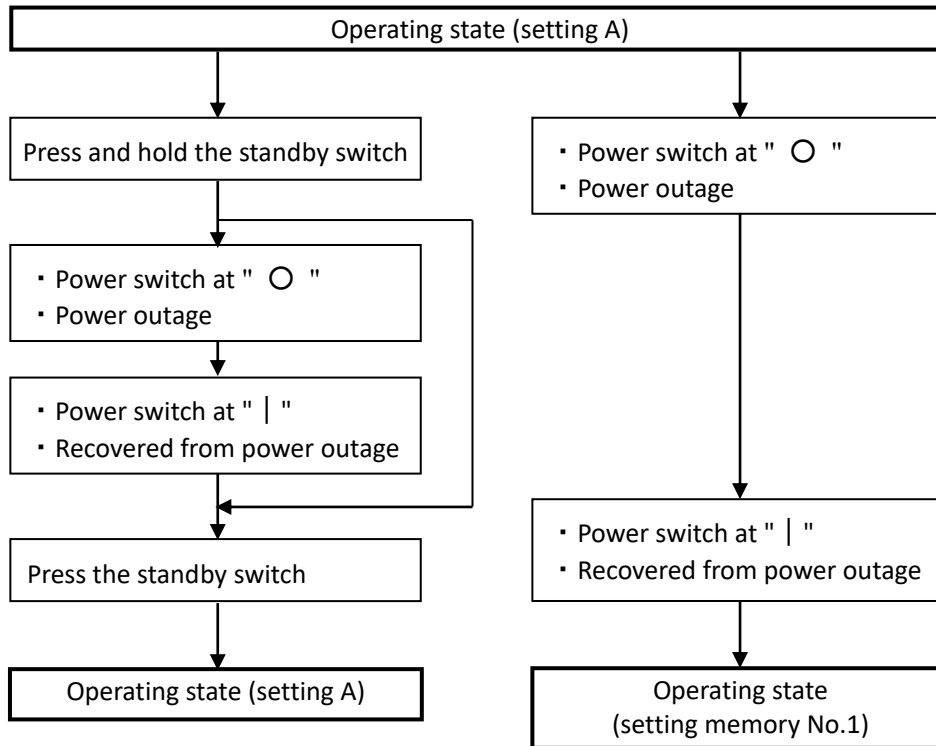

If the instrument has stopped operating because of a power outage or the power switch being turned off during operation, the power will be turned on automatically by the process for recovery from a power outage or by switching on the power with the power switch (standby switch operation is not necessary). When power is restored in this way, however, the settings are not restored to the settings at the time of power interruption. Instead, the settings are retrieved from setting memory No.1. For more information on the setting memory, refer to "5.12 Memory operations".

4.1.4 Startup screen and operation

When the power is turned on, the startup screen is displayed. For the first several seconds, all of the lamps are lit for operation check.

During that time, internal initialization and self-diagnosis are performed. If an abnormality occurs, an error message is displayed. In that case, set the power switch on the rear panel to the off position, wait at least five seconds, and then set the power switch back to the on position. If the error occurs again, the instrument may be malfunctioning, so please contact the NF Corporation or its authorized agent.



Start up screen

When the instrument starts up normally, the initial screen is displayed.

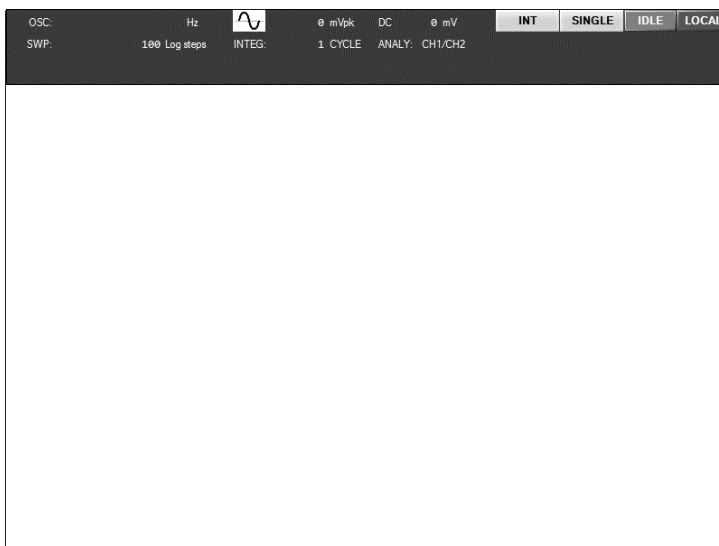

Initial screen

From this point on, operations such as setting and measurement, etc. are possible.

4.2 Simple operation for the first use

The procedures for performing a basic measurement is described here.

4.2.1 Common operations

■ Initialization

Initialize this instrument as follows.

Select **【Other】** – [RESET] and press the **ENTER** key to display the confirmation message on the LCD screen. Press the **ENTER** key or tap on the [OK] button to initialize the settings.

For a description of what is initialized, read "3.6 Initial settings".

■ BASIC SETUP key

Press the **BASIC SETUP** key on the front panel to display the Basic Setup shortcut menu for quickly setting items that are frequently changed.

Basic Setup	
SWEEP LOWER	10 Hz
SWEEP UPPER	100 kHz
AMPLITUDE	1 Vpk
INTEGRATION	1 cycle

[SWEEP LOWER] : Set the sweep frequency lower limit.

[SWEEP UPPER] : Set the sweep frequency upper limit.

[AMPLITUDE] : Set the AC amplitude.

[INTEGRATION] : Set the number of integration times or duration.

For more information on changing settings, read "3.3.1 Menu operations".

4.2.2 Measuring loop gain

The results of measuring the loop characteristics (loop gain characteristic) of a negative feedback loop are phase margin and gain margin, which are indicators of negative feedback loop stability. The basic connections for measuring the loop gain are illustrated below.

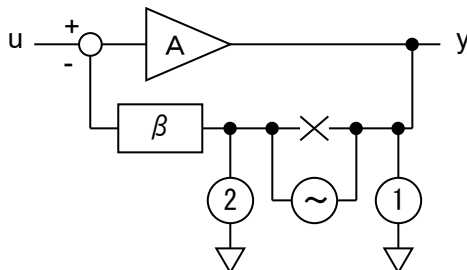

Figure 4-1 Connections for loop gain measurement

The set up and measurement method for a typical DC-DC converter are explained below.

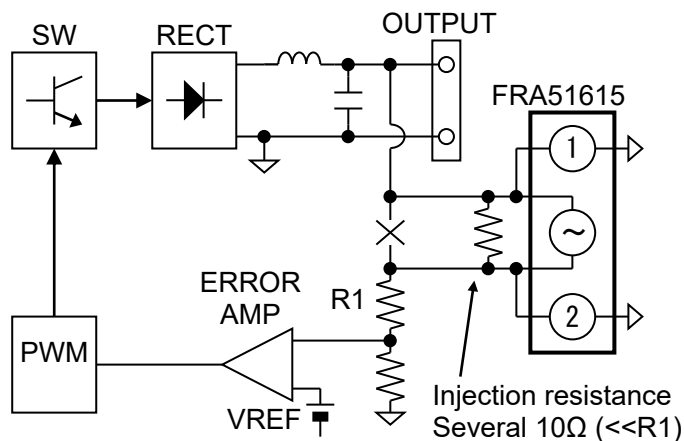

Figure 4-2 Example of connections for measuring the loop gain of a DC-DC converter

The injection resistance in the above diagram is inserted to prevent an open loop if the measurement probe is removed from the circuit being measured. The resistance value is several tens of ohms or less and sufficiently smaller than $R1$.

Warning

- A large output may be generated if the control loop is broken, resulting in possible damage to the equipment under test or risk of injury to the user. Ensure that an open control loop does not occur even if the probe is disconnected from the instrument by using an injection resistance. Secure the injection resistance firmly to ensure that it remains in place.
 - If the injected signal level is too high, the generated output may be large enough to damage the equipment under test or create a risk of injury to the user. Begin with a low signal level and increase it gradually, with sufficient checking for safety.
-

Using the optional "PA-001-0369 LOOP GAIN MEASUREMENT ADAPTER" simplifies the connection between the circuit under test and the instrument and reduces the possibility of incorrect wiring. However, using the adapter restricts the voltage to ± 42 V. For more information, refer to the instruction manual of the "PA-001-0369 LOOP GAIN MEASUREMENT ADAPTER".

Follow the procedure described below for instrument set-up and performing measurements.

- 1) Initialize the settings.
- 2) Press the **BASIC SETUP** key and change the settings if necessary. In most cases, loop gain measurements can be performed without problem with the settings other than measurement amplitude (AMPLITUDE) left unchanged.
 - [SWEEP LOWER] : Sweep frequency lower limit
 - [SWEEP UPPER] : Sweep frequency upper limit
 - [AMPLITUDE] : Measurement amplitude

Denoting the output voltage of the DC-DC converter that is being measured as V , set the value to approximately $V/50$ or less. If the output voltages 5 V, set the value to about 100 mVpk; for an output voltage of 400 V, set the value to about 8 Vpk.
 - [INTEGRATION] : Number of integration rounds.
- 3) Press the **AC/DC ON** key on the front panel to turn the oscillator output on.
- 4) Press the **MEASURE DOWN** key on the front panel to perform a sweep measurement and wait until the measurement is completed.
- 5) Turning the knob moves the marker on the measurement data. Search for the frequency at which the gain is closest to 0 dB. The phase at that frequency is the phase margin. That frequency (the zero cross frequency) is a measure of the control response speed of the circuit under test.

6) In the same way, turn the knob to find the frequency at which the phase is closest to 0° . The gain at that frequency is the gain margin. Because the frequency is relatively high, it may be difficult to clearly read the gain margin because of noise, etc. for some circuits. In that case, it is possible to evaluate the loop stability by using the phase margin alone.

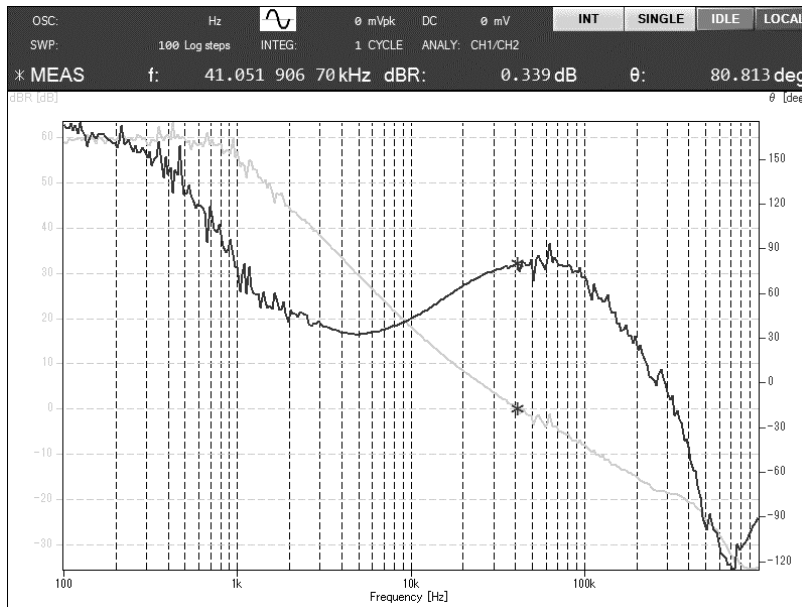

As was explained in the most general example for measuring a DC-DC converter, change the measurement frequency range, oscillator amplitude, and number of integration rounds as is appropriate for the characteristics of the circuit being measured.

Set the DC bias of the instrument oscillator to 0 V. Regardless of the output voltage of the circuit being measured, it is not necessary to set the DC bias when measuring loop gain.

■ Cautions concerning loop gain measurements

This instrument measures and displays loop characteristics rather than $A\beta$ characteristics. In the block diagram presented in "Figure 4-1 Connections for loop gain measurement", the polarity reversing part of the feedback on the input side of the amplifier element (A) is included in the measurement. That is to say, $-A\beta$ is measured. In general automatic control theory explanations, loop characteristics are usually treated as $A\beta$, so the phase margin is defined as the difference from 180° . For measurements with this instrument, however, the phase margin is defined as the difference from 0° . Also, when the Nyquist plot is displayed, the position that indicates the stability limit is $(+1+j0)$ rather than $(-1+j0)$.

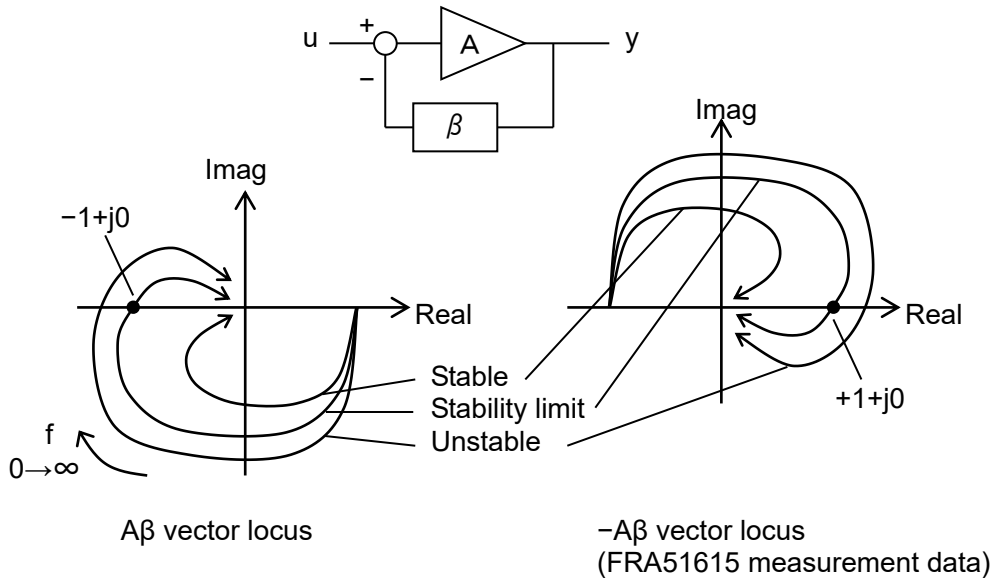

Figure 4-3 Nyquist plots obtained from actual measurements

Although the position for indicating the stability limit is shifted, the vector locus is also rotated 180° at the origin, so the method for determining stability is the same as for an ordinary Nyquist plot.

4.2.3 Measuring the gain-phase characteristic

This is the method for measuring the transfer frequency characteristics of amplifiers and filters, etc.

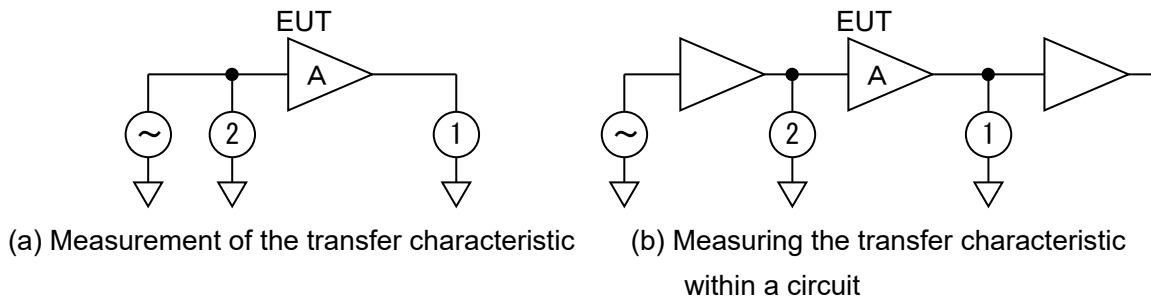

Figure 4-4 Example of connections for gain-phase measurement

The characteristics of the equipment under test can be obtained by measurement with the connections illustrated in Figure 4-4. When measuring the input-output characteristics (Figure 4-4 (a)), it is convenient to use the BNC adapter that is provided with the instrument. Measurement accuracy can be increased by placing the BNC adapter on the input side of the equipment under test.

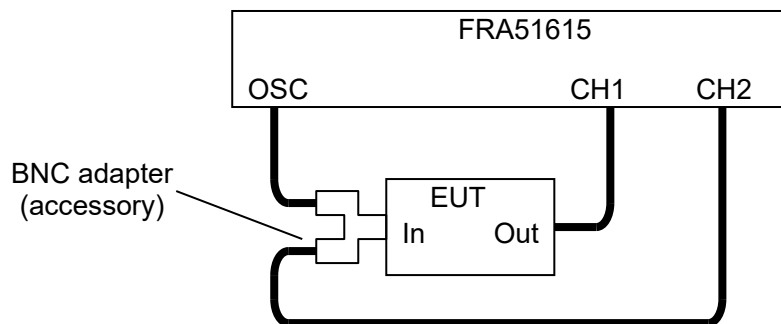
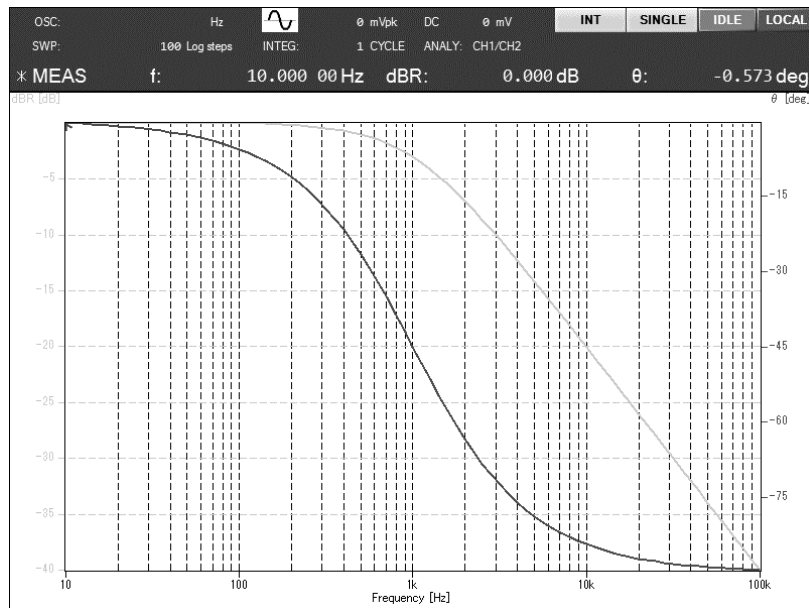

Figure 4-5 Example of connections for transfer characteristic measurement

Follow the procedure described below for instrument set-up and performing measurements.

- 1) Initialize settings.
- 2) Press the **BASIC SETUP** key and change the settings as necessary.
 - [SWEEP LOWER] : Sweep lower frequency
 - [SWEEP UPPER] : Sweep upper frequency
 - [AMPLITUDE] : Measurement amplitude
 - [INTEGRATION] : Number of integration rounds
- 3) Press the **AC/DC ON** key on the front panel to turn the oscillator output on.

- 4) Press the MEASURE **DOWN** key on the front panel to perform a sweep measurement and wait until the measurement is completed.



- 5) Turning the knob moves the marker on the measurement data. You can read the gain or phase at any frequency. You can also detect maximum values, search, find the location of an arbitrary gain value, and perform other such operations. For more information on the operations, read "5.6 Marker operations".

4.2.4 Measuring impedance

Impedance is defined as the ratio of the voltage and current of the device under test (DUT). The current of the sample is converted to voltage using a shunt resistor. By measuring the voltage of the shunt resistor and the sample simultaneously, the impedance of the sample can be obtained. The DUT voltage and the voltage converted from the DUT current are connected to CH1 and CH2 respectively..

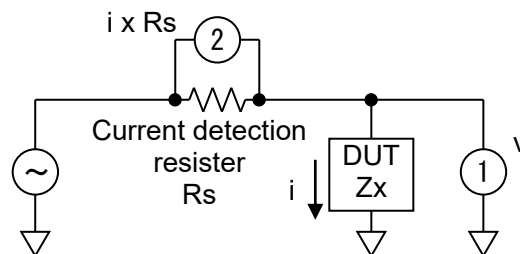

Figure 4-6 Example of connections for measuring impedance

This instrument can be easily connected to DUTs by using the optional "PA-001-0368 IMPEDANCE MEASUREMENT ADAPTER". For more information, please refer to the instruction manual of "PA-001-0368 IMPEDANCE MEASUREMENT ADAPTER".

The voltage of the DUT current $i \times R_s$ is input to CH2 from the current detection resistance R_s . By setting the CH2 input weight coefficient to $1/R_s$ and measuring the ratio of CH1 and CH2, the impedance value can be read directly as the gain (ratio voltage and current). For more information on the input weight coefficient, read "5.9.2 Input weighting".

Follow the procedure described below for instrument set-up and performing measurements.

1) Initialize settings.

2) Set the display unit to impedance.

Set **[Graph]** — **[DISPLAY UNIT]** to IMPEDANCE.

3) Set the graph Y axis display item.

Select with **[Graph]** dialog — **[DISPLAY MODE]**[**Y AXIS**]. For more information, read "3.5.4 Graph dialog".

4) Press the **BASIC SETUP** key and change the settings as necessary.

[SWEEP LOWER] : Sweep lower frequency

[SWEEP UPPER] : Sweep upper frequency

[AMPLITUDE] : Measurement amplitude

[INTEGRATION] : Number of integrations

5) Press the **AC/DC ON** key on the front panel to turn the oscillator output on.

6) Press the **MEASURE DOWN** key on the front panel to perform a sweep measurement and wait until the measurement is completed.

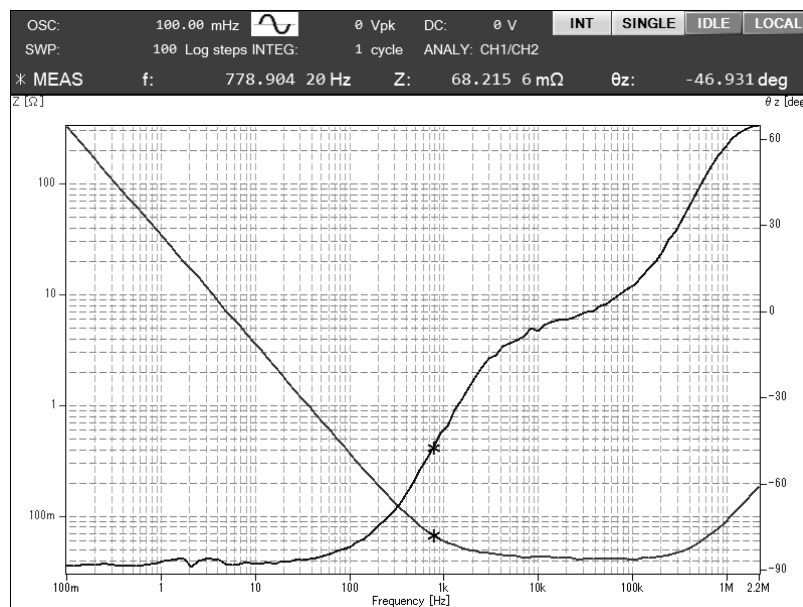

7) Turn the knob to move the marker on the measurement data. You can read the measured value at any frequency. You can also detect maximum values, search, find the location of an arbitrary gain value, and perform other such operations. For more information on the operations, read "5.6 Marker operations".

If the OSC output of the instrument is amplified with a power amplifier, it is possible to measure the impedance by applying a large voltage/current to the DUT. A large amplitude or DC bias (voltage/current) can be used to measure a change in the impedance characteristic caused by a nonlinearity such as saturation of a magnetic or dielectric material.

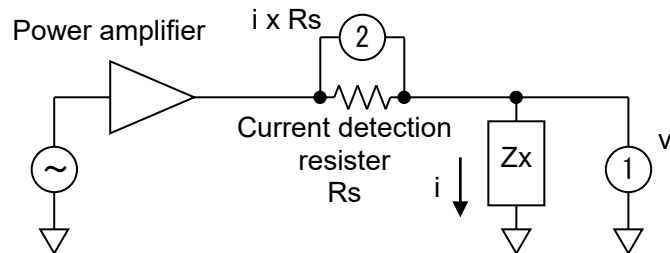

Figure 4-7 Example of connections for measuring impedance with high-power

The wiring and connections are simplified by using the optional "PA-001-1840 HI-POWER IMPEDANCE MEASUREMENT ADAPTER (1 ohm)" or the "PA-001-1841 HI-POWER IMPEDANCE MEASUREMENT ADAPTER (100 ohm)". For more information, refer to the instruction manual of each adapter.

4.3 Oscillator settings

The basic setup and operation of the oscillator are described in this section.

■ **Setting the output on or off**

Use the OSC key on the front panel.

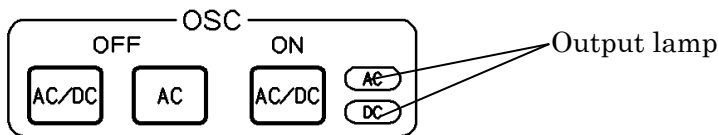

The output lamps that are to the right of the **AC/DC ON** key are lit when corresponding AC or DC is being output.

Pressing the **AC/DC ON** key turns on both the AC output and the DC output.

Pressing the **AC/DC OFF** key turns off both the AC output and the DC output.

Pressing the **AC OFF** turns off the AC output, but the DC output remains on.

It is also possible to turn the output on at the beginning of measurement and have the output turn off automatically when the measurement is completed. That function is convenient for minimizing the signal that is applied to the circuit or DUT being measured. For more information, read "5.4.4 Measurement synchronization".

■ **Setting the frequency**

The method for setting the oscillator frequency is described here. It is possible to set the frequency over the range from 10 μ Hz to 15 MHz with a resolution of 10 μ Hz. This frequency setting is for performing measurements with a fixed frequency (SPOT measurement).

Select **[OSC] — [FREQUENCY]**.

OSC	
FREQUENCY	1 kHz
AMPLITUDE	1 Vpk
DC BIAS	0 V
OUTPUT CONNECTOR	FRONT
ON/OFF SYNC	ASync
ON/OFF MODE	QUICK
STOP MODE	QUICK
WAVEFORM	SINE
10MHz REF	
IN	DISABLE
OUT	DISABLE
AMPLITUDE COMPRESSION >	OFF

The frequency is set by tapping the function keys at the bottom of the LCD screen.

- [SWEEP MIN -> FREQ] : Set the lower limit for the sweep frequency.
- [SWEEP MAX -> FREQ] : Set the upper limit for the sweep frequency.
- [MKR -> FREQ] : Set the main marker frequency.
- [ΔMKR -> FREQ] : Set the delta marker frequency.
- [DIRECT NEW] : Set an arbitrary frequency.
- [DIRECT EDIT] : Edit the current frequency setting.

Changing the frequency setting immediately changes the oscillator output frequency.

When a sweep measurement is performed, the setting changes according to the sweep frequency. When a sweep is completed, the setting value becomes the frequency at the end of the sweep.

■ Setting the AC amplitude

The AC amplitude for measurement is set in the range from 0 to 10 Vpk.

Select **[OSC]** —**[AMPLITUDE]**.

OSC	
FREQUENCY	1 kHz
AMPLITUDE	1 Vpk
DC BIAS	0 V
OUTPUT CONNECTOR	FRONT
ON/OFF SYNC	ASYN
ON/OFF MODE	QUICK
STOP MODE	QUICK
WAVEFORM	SINE
10MHz REF	
IN	DISABLE
OUT	DISABLE
AMPLITUDE COMPRESSION >	OFF

The AC amplitude is set by tapping the function keys at the bottom of the LCD screen.

- [DIRECT NEW] : Set an arbitrary frequency.
- [DIRECT EDIT] : Edit the current frequency setting.

● Cautions concerning the AC amplitude setting

Simply setting a value for the AC amplitude does not change the actual amplitude of the oscillator output until the **[AC/DC ON]** key is pressed. Even if the AC and DC output lamps are lit, it is necessary to press the **[AC/DC ON]** key to change the actual output amplitude.

● Constraints on the AC amplitude setting range and the DC bias setting range

The settings for the AC amplitude and the DC bias are limited to a total of ± 10 V. If the DC bias is set to 0 V, the AC amplitude can be set to a value of up to 10 Vpk. Please note that if the DC bias is set to +1.2 V (or -1.2 V), the AC amplitude setting range is restricted to a maximum of 8.8 Vpk.

■ Setting the DC bias

The DC bias that is applied to the circuit or DUT is set in the range from -10 V to $+10\text{ V}$.

Select **[OSC]** — **[DC BIAS]**.

OSC	
FREQUENCY	1 kHz
AMPLITUDE	1 Vpk
DC BIAS	0 V
OUTPUT CONNECTOR	FRONT
ON/OFF SYNC	ASYNC
ON/OFF MODE	QUICK
STOP MODE	QUICK
WAVEFORM	SINE
10MHz REF	
IN	DISABLE
OUT	DISABLE
AMPLITUDE COMPRESSION >	OFF

The DC bias is set by tapping the function keys at the bottom of the LCD screen.

[DIRECT NEW]: Set an arbitrary DC bias value.

[DIRECT EDIT]: Edit the current DC bias setting.

● Selecting the DC bias output connector

Normally, the DC bias output from the OSC connector on the front panel, being added to the AC output.

If **[OSC]** — **[OUTPUT CONNECTOR]** is set to **[REAR]**, the DC bias is output from the DC BIAS OUT connector on the rear panel. In that case, please note that the DC bias is not output from the OSC connector on the front panel. This is used when the DC bias applied to the circuit or DUT being measured is supplied via a different path than the AC signal used for measurement.

● Cautions concerning the DC bias settings

Simply changing the DC bias settings (magnitude and output location) does not change the DC bias output until the **[AC/DC ON]** key is pressed. Even if the AC and DC output lamps are lit, it is necessary to press the **[AC/DC ON]** key to change the actual DC bias output.

● Constraints on the setting range of the AC amplitude and the DC bias

The settings for the AC amplitude and the DC bias are limited to a total of $\pm 10\text{ V}$. If the DC bias is set to 0 V , the AC amplitude can be set to a value of up to 10 Vpk . Please note that if the DC bias is set to $+1.2\text{ V}$ (or -1.2 V), the AC amplitude setting range is restricted to a maximum of 8.8 Vpk .

■ Setting the waveform

Select the oscillator output waveform from among sinusoidal (SINE), square (SQUARE), and triangular (TRIANGLE).

Select **【OSC】** —[WAVEFORM].

OSC	
FREQUENCY	1 kHz
AMPLITUDE	1 Vpk
DC BIAS	0 V
OUTPUT CONNECTOR	FRONT
ON/OFF SYNC	ASync
ON/OFF MODE	QUICK
STOP MODE	QUICK
WAVEFORM	SINE
10MHz REF	SQUARE
IN	TRIANGLE
OUT	
AMPLITUDE COMPRESSION >	OFF

The waveform that is set is displayed as an icon in the upper part of the screen.

Normally, the sinusoidal waveform (SINE) is used. The measurement accuracy of this instrument is always specified for the sinusoidal waveform. The square and triangular waveforms are used for checking the operation of the circuit being measured; they are not suitable for measuring frequency characteristics with this instrument.

For information on advanced oscillator settings other than described above, refer to "5.4 Oscillator control".

4.4 Integration

This instrument performs measurement processing as a discrete Fourier transform (DFT) in units of one cycle of the measurement waveform. By nature, the DFT essentially removes noise and high-frequency harmonics. However, if the signal component being measured is small relative to the noise, or if highly accurate measurement is required, the accuracy of measurement can be improved by increasing the integration period (the number of integrations).

White noise is reduced in rough proportion to the square root of the integration setting (number or duration of integrations). Noise components other than the measurement frequency are also reduced by increasing the integration setting. However, the time required for measurement increases in proportion to the number of integrations.

■ Setting the integration mode

There are two integration modes: manual integration, in which the number of integrations is predetermined, and automatic integration, in which the number of integrations is adjusted automatically according to the measurement data.

Select **[OSC]** — **[INTEGRATION MODE]**.

Measure	
INTEGRATION MODE	FIX
INTEGRATION	SHORT
START DELAY	MED
MEAS DELAY	LONG
d/dt	

[FIX]	: Manual integration
[SHORT]	: Automatic integration (short time)
[MED]	: Automatic integration (medium time)
[LONG]	: Automatic integration (long time)

● Manual integration

The normal setting is **[FIX]**. The integration is performed according to the number of times or the duration that is set in **[INTEGRATION]**.

● Automatic integration

The number of integrations is determined by monitoring the variance of the measurement results (DFT results). The integration is performed repeatedly in the order **SHORT < MED < LONG** until the variance becomes small. Clean data is thus obtained, but the measurement time is long.

When the signal-to-noise ratio decreases only within a particular frequency range within the sweep range, it may be possible to obtain clean data in a short time as the result of automatic integration.

However, because the number of integration times is determined on the basis of a statistic (variance), the integration may end while the signal-to-noise ratio is insufficient or the integration may be repeated more times than is necessary, depending on the nature of the signal being measured. (The integration

must be performed at least three times to obtain the statistic.) Furthermore, it is not possible to predict the time required to finish the sweep in advance. Before using automatic integration, you should perform preliminary experiments.

■ Integration settings

This sets the number of integration rounds or duration for the manual integration mode (FIX), and the upper limit in automatic integration mode.

Measure	
INTEGRATION MODE	FIX
INTEGRATION	1 cycle
START DELAY	0 sec
MEAS DELAY	0 sec
d/dt	OFF

The integration setting is set as the number of integration times (cycles) or as a duration (s). When set as a duration, the value is converted to a number of cycles internally for operation of the instrument.

Regardless of the setting, integration is necessarily performed at least one time.

The measurement time for each frequency varies with the number of integrations and the measurement frequency (f [Hz]). The measurement time (s) is estimated as described below, where N is the number of integration cycles.

(When the number of integration cycles is from 1 to 11)

- When the sweep density setting (**[Sweep]** – [SWEEP RESOLUTION]) is 200 or less

- $f < 1.36 \text{ kHz}$: $(1/f) \times N$
- $1.36 \text{ kHz} \leq f < 50 \text{ kHz}$: $(1 \text{ ms to } 1.5 \text{ ms}) \times N$
- $50 \text{ kHz} \leq f$: approximate $0.5 \text{ ms} \times N$

- When the sweep density setting (**[Sweep]** – [SWEEP RESOLUTION]) is from 201 to 20,000

- $f < 1.36 \text{ kHz}$: $(1/f) \times N + 1 \text{ ms}$
- $1.36 \text{ kHz} \leq f < 50 \text{ kHz}$: $(1 \text{ ms to } 1.5 \text{ ms}) \times N + 1 \text{ ms}$
- $50 \text{ kHz} \leq f$: approximate $0.5 \text{ ms} \times N + 1 \text{ ms}$

(When the number of integration cycles is from 12 to 1,677)

- $f < 1.36 \text{ kHz}$: $(1/f) \times (N - 11) \times 12$
- $1.36 \text{ kHz} \leq f < 3 \text{ kHz}$: $(1 \text{ ms to } 1.5 \text{ ms}) \times (N - 11) \times 12$
- $3 \text{ kHz} \leq f$: approximate $20 \text{ ms} \times (N - 11)$

(When the number of integration cycles is from 1,678 to 20,000)

- $f < 1.36 \text{ kHz}$: $(1/f) \times 20,000$
- $1.36 \text{ kHz} \leq f < 3 \text{ kHz}$: $(1 \text{ ms to } 1.5 \text{ ms}) \times 20,000$
- $3 \text{ kHz} \leq f$: approximate $20 \text{ ms} \times (N - 11)$

4.5 Measurement control

This section explains how to start and stop the measurement process of this instrument.

The instrument can perform sweep measurements and spot measurements.

Sweep measurement : The frequency response characteristic is measured by sweeping over frequencies and the measurement results are displayed as a graph. Sweep measurements include upsweep measurements, which measure over increasing frequencies and downsweep measurements, which measure over decreasing frequencies.

Spot measurement : The measurement is performed at the frequency that has been set. The measurement result is displayed at the center of the LCD screen in large characters.

Measurement control is performed by using the MEASURE keys on the front panel.

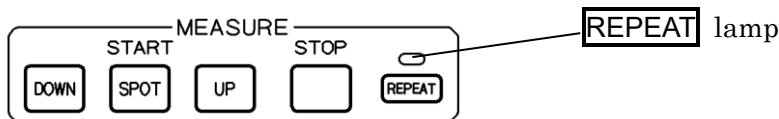

DOWN key : Start a downsweep measurement

SPOT key : Start a spot measurement

UP key : Start an upsweep measurement

STOP key : Stop measurement

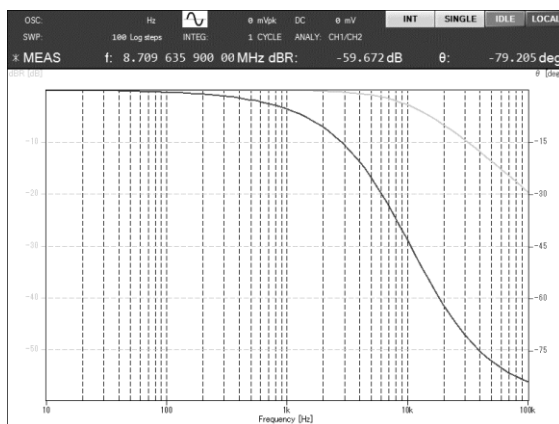

Example of display after a sweep measurement

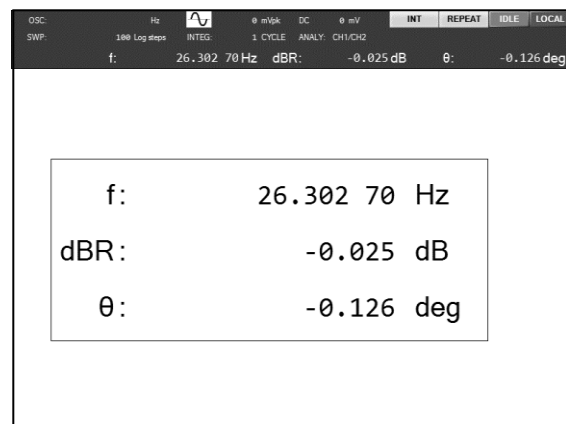

Example of display after a spot measurement

■ Repeated measurements

Pressing the **REPEAT** key sets the instrument to automatically repeat measurements. If the **REPEAT** lamp is lit, measurements are repeated for both sweep measurements and spot measurements. If the **REPEAT** lamp is not lit, the instrument goes into standby mode after a measurement is completed.

Pressing the **REPEAT** toggles the **REPEAT** lamp that is above the key on and off.

During repeat measurement, most operations such as saving or restoring settings or data and initialization are not performed. To perform such operations, stop the measurement.

4.6 Graph display mode

The basic graph display mode settings are explained in this section. For more information on the functions, refer to "5.5 Graph display".

■ Setting the display unit

To set the unit used when displaying measurement data, select either gain-phase or impedance. The graph display differs according to the display unit that is set. Use **【Graph】** – [DISPLAY UNIT] to select [GAIN] or [IMPEDANCE].

■ Setting the display mode

Use **【Graph】** – [DISPLAY MODE] to select what is to be displayed on the X axis, Y1 axis, and Y2 axis of the graph. The items that can be selected vary according to the analysis mode setting. The possible graph display combinations are shown in the following table. If settings other than shown in the table are used, nothing at all is displayed on the graph. "LIN" represents a linear axis scale and "LOG" represents a logarithmic axis scale. "✓" or "✗" symbol indicates whether linear or logarithmic axis setting is possible.

Table 4-1 Display modes for display unit GAIN

○ Analysis mode: (CH1/CH2) or (CH2/CH1)

X axis	LIN	LOG	Y1 axis	LIN	LOG	Y2 axis	LIN	LOG	Comments
SWEEP	✓	✓	R	✓	✓	θ	✓	✗	Bode plot
SWEEP	✓	✓	dB	✓	✗	θ	✓	✗	
SWEEP	✓	✓	a	✓	✗	b	✓	✗	
SWEEP	✓	✓	R	✓	✓	GD	✓	✓	
SWEEP	✓	✓	dB	✓	✗	GD	✓	✓	
θ	✓	✗	R	✗	✓	—	—	—	Nichols plot
θ	✓	✗	dB	✓	✗	—	—	—	
a	✓	✗	b	✓	✗	—	—	—	Nyquist plot

If the analysis mode is (CH1/CH2) or (CH2/CH1), gain is displayed as reciprocal data (reverse polarity for dB units) and phase is displayed as reverse polarity data.

○ Analysis mode: (CH1)

X axis	LIN	LOG	Y1 axis	LIN	LOG	Y2 axis	LIN	LOG	Comments
SWEEP	✓	✓	R	✓	✓	—	—	—	

○ Analysis mode: (CH2)

X axis	LIN	LOG	Y1 axis	LIN	LOG	Y2 axis	LIN	LOG	Comments
SWEEP	✓	✓	R	✓	✓	—	—	—	

Table 4-2 Display modes for display unit IMPEDANCE

○ Analysis mode: (CH1/CH2) or (CH2/CH1)

X axis	LIN	LOG	Y1 axis	LIN	LOG	Y2 axis	LIN	LOG	Comments
SWEEP	✓	✓	Z	✓	✓	θ_z	✓	✗	
SWEEP	✓	✓	Y	✓	✓	θ_y	✓	✗	
SWEEP	✓	✓	R	✓	✗	X	✓	✗	
SWEEP	✓	✓	G	✓	✗	B	✓	✗	
SWEEP	✓	✓	Cp	✓	✗	Rp	✓	✗	
SWEEP	✓	✓	Cp	✓	✗	D	✓	✗	
SWEEP	✓	✓	Cp	✓	✗	Qc	✓	✗	
SWEEP	✓	✓	Cs	✓	✗	Rs	✓	✗	
SWEEP	✓	✓	Cs	✓	✗	D	✓	✗	
SWEEP	✓	✓	Cs	✓	✗	Qc	✓	✗	
SWEEP	✓	✓	Lp	✓	✗	Rp	✓	✗	
SWEEP	✓	✓	Lp	✓	✗	QL	✓	✗	
SWEEP	✓	✓	Ls	✓	✗	Rs	✓	✗	
SWEEP	✓	✓	Ls	✓	✗	QL	✓	✗	
R	✓	✗	X	✓	✗	—	—	—	Complex impedance plane
R	✓	✗	-X	✓	✗	—	—	—	Cole-Cole plot
G	✓	✗	B	✓	✗	—	—	—	Complex admittance plane
G	✓	✗	-B	✓	✗	—	—	—	

There is no difference in display, regardless of whether the analysis mode setting is (CH1/CH2) or (CH2/CH1).

○ Analysis mode: (CH1)

X axis	LIN	LOG	Y1 axis	LIN	LOG	Y2 axis	LIN	LOG	Comments
SWEEP	✓	✓	V	✓	✓	—	—	—	

○ Analysis mode: (CH2)

X axis	LIN	LOG	Y1 axis	LIN	LOG	Y2 axis	LIN	LOG	Comments
SWEEP	✓	✓	I	✓	✓	—	—	—	

The axis setting parameters are described and their units are given in the following table.

Table 4-3 Graph axis parameters for display unit GAIN

Analysis mode	Axis setting	Description	Unit
CH1/CH2 CH2/CH1	SWEEP	Frequency	Hz
	R	Gain	None (ratio)
	dBR	Gain	dB
	θ	Phase	deg
	a	Real part of gain	None (ratio)
	b	Imaginary part of gain	None (ratio)
	GD	Group delay	s
CH1, CH2	R	Amplitude	Vrms

Table 4-4 Graph axis parameters for display unit IMPEDANCE

Analysis mode	Axis setting	Description	Unit
CH1/CH2 CH2/CH1	SWEEP	Frequency	Hz
	Z	Impedance	Ω
	Y	Admittance	S
	θ_z	Impedance phase	deg
	θ_y	Admittance phase	deg
	R	Resistance	Ω
	X	Reactance	Ω
	G	Conductance	S
	B	Susceptance	S
	Lp	Parallel inductance	H
	Ls	Series inductance	H
	Cp	Parallel capacitance	F
	Cs	Series capacitance	F
	Rp	Parallel resistance	Ω
	Rs	Series resistance	Ω
	Qc	Quality factor (capacitance)	None
	D	Dissipation factor	None
QL	Quality factor (inductance)	None	
CH1, CH2	V	Voltage amplitude	Vrms
	I	Current amplitude	Arms

■ Converting measurement data to display parameters

The formulas for converting the various parameter formats that are used for measurement and display by this instrument are explained in this section.

Let \dot{V}_1 and \dot{V}_2 respectively denote the voltage vectors obtained by Fourier transforms of the signals measured at analysis input connectors CH1 and CH2. The parameters are defined as shown below.

$$\begin{aligned}
 V_1 [\text{Vrms}] &= |\dot{V}_1| & V_2 [\text{Vrms}] &= |\dot{V}_2| \\
 g &= |\dot{V}_1| \div |\dot{V}_2| \\
 p [\text{rad}] &= \angle \dot{V}_1 - \angle \dot{V}_2 & \theta_1 [\text{deg}] &= p \times 180 \div \pi \\
 \text{Measurement frequency [Hz]} &= f & \text{Measurement angular frequency [rad/s]} &= \omega = 2 \times \pi \times f
 \end{aligned}$$

Table 4-5 Display parameter conversion formulas for display unit GAIN

○ Analysis mode: (CH1/CH2)

Display parameter	Unit	Formula	Comments
R	None	g	Gain
dB	dB	$20 \times \log_{10}(g)$	Gain
θ	deg	θ_1	Phase
a	None	$g \times \cos(p)$	Real part of gain
b	None	$g \times \sin(p)$	Imaginary part of gain
GD	s	$-\partial p / \partial \omega$	Group delay

○ Analysis mode: (CH2/CH1)

Display parameter	Unit	Formula	Comments
R	None	$1 \div g$	Gain
dB	dB	$-20 \times \log_{10}(g)$	Gain
θ	deg	$-\theta_1$	Phase
a	None	$(1 \div g) \times \cos(p)$	Real part of gain
b	None	$-(1 \div g) \times \sin(p)$	Imaginary part of gain
GD	s	$\partial p / \partial \omega$	Group delay

○ Analysis mode: (CH1)

Display parameter	Unit	Formula	Comments
R	Vrms	V_1	CH1 amplitude

○ Analysis mode: (CH2)

Display parameter	Unit	Formula	Comments
R	Vrms	V_2	CH2 amplitude

Table 4-6 Display parameter conversion formulas for display unit IMPEDANCE

○ Analysis modes (CH1/CH2) and (CH2/CH1)

Display parameter	Unit	Formula	Comments
Z	Ω	g	Impedance
θ_z	deg	θ_1	Impedance phase
Y	S	$1 \div g$	Admittance
θ_y	deg	$-\theta_1$	Admittance phase
R	Ω	$g \times \cos(p)$	Resistance
X	Ω	$g \times \sin(p)$	Reactance
G	S	$(1 \div g) \times \cos(p)$	Conductance
B	S	$-(1 \div g) \times \sin(p)$	Susceptance
Ls	H	$g \times \sin(p) \div \omega$	Series inductance
Lp	H	$g \div (\omega \times \sin(p))$	Parallel inductance
Cs	F	$-1 \div (g \times \omega \times \sin(p))$	Series capacitance
Cp	F	$-\sin(p) \div (g \times \omega)$	Parallel capacitance
Rs	Ω	$g \times \cos(p)$	Series resistance
Rp	Ω	$g \div \cos(p)$	Parallel resistance
QL	None	$\tan(p)$	Quality factor (inductor)
Qc	None	$-\tan(p)$	Quality factor (capacitor)
D	None	$-1 \div \tan(p)$	Dissipation factor

○ Analysis mode: (CH1)

Display parameter	Unit	Formula	Comments
V	Vrms	V_1	Voltage amplitude

○ Analysis mode: (CH2)

Display parameter	Unit	Formula	Comments
I	Arms	V_2	Current amplitude

4.7 High-frequency measurements

At frequencies above several hundreds of kilohertz, the effect of signal cables on measurement error tends to increase with the frequency. The main points of caution for measuring at high frequencies are explained in this section.

a) Auto-range

In the default settings, CH1 and CH2 are both set to auto-range. This setting simplifies measurement because the measurement range is switched automatically according to the magnitude of the signal, but error becomes large at high frequencies. For that reason, small steps (discontinuities) may appear in the measurement data before and after range switching.

The problem of discontinuities in measurement results can be solved by performing the measurement in a fixed range but, that greatly reduces the dynamic range of the measurement. Also, if a signal that exceeds the range is input, correct results cannot be obtained because of excessive signal level. When measuring with a fixed range, consider these constraints when determining the measurement range.

b) Using the probe

When measuring at high frequencies, the static capacitance between wires of the signal cable may act as a load on the circuit being measured, greatly affecting the measurement results and the operation of the circuit being measured. When the cables are long (several percent of the wavelength of the measurement signal), the influence of signal reflection due to impedance mismatch surfaces and measurement error increases. In such cases, it is recommended to use a suitable probe to reduce measurement error.

For example, a 10:1 passive probe intended for use with an oscilloscope can be used. Use a probe that has an impedance of $1\text{ M}\Omega$ on the oscilloscope side in the correction range and a maximum capacitance correction range of at least 25 pF. Adjust the trimmer capacitor of the probe so that the frequency characteristic is flat before measurement. Specifically, set the analysis mode to the channel the probe is connected to (CH1 or CH2) and perform a sweep measurement over the range from about 10 Hz to 100 kHz while measuring the OSC output signal with the probe and adjust the trimmer capacitor so that the difference in gain between the low region and the high region is minimum.

Using a 10:1 passive probe attenuates the signal level to 1/10, but it is possible to compensate for that approximately by setting a suitable input weighting. For more information on input weighting, refer to "5.9.3 Input weighting".

The equalizing function can be used for more accurate correction of probe errors. For more information on the equalizing function, refer to "5.9.4 Equalizing".

c) Cable length and routing

The output BNC connector of OSC and the input BNC connectors of CH1 and CH2 are each electrically isolated from the instrument enclosure. The impedance is high and can be treated as approximately infinite impedance for DC or at mains frequencies. At higher frequencies, however, the isolation impedance decreases due to the stray capacitance to the enclosure, facilitating current flow from the outer conductor (shielding) of the cable to ground.

If the connecting cable is long, resonance of the cable inductance and the isolation capacitance may perturb the frequency characteristics or make measurement impossible. At the (series) resonance frequency, the isolation impedance becomes very small, resulting in a state that is the same as if the signal cable shielding were grounded. That condition may be improved by attaching a common mode choke to the cable. For example, a ferrite core clamp such as used to prevent noise or electromagnetic interference can be attached to the cable.

If the signal cables are rearranged, the coupling between cables and the impedance relative to ground change, so changes in the measurement results may be observed. In such cases, fix the cables in place so that they do not move to improve the reproducibility of the measurement results.

d) Impedance matching

It is possible to suppress reflection in the signal cable and achieve stable measurement at higher frequencies by attaching a commercial feedthrough type 50 Ω terminator to the input BNC connectors of CH1 and CH2. (It may be necessary to use a 50 Ω class coaxial cable for the signal cable.)

[Information]

- For a 50 Ω class coaxial cable (such as the included BNC cable, RG-58A/u, or 3D-2V, etc.), the propagation delay is about 5 ns per meter. Converting to phase, that is equivalent to 1.8° at 1 MHz.
- For a 50 Ω class coaxial cable, there is about 100 pF of electrostatic capacitance per meter (between the core wire and shield). When driven by signal source resistance of 50 Ω , the gain change is about -0.0043 dB and the phase change is -1.8 deg at 1 MHz.
- Take care to keep the connector contacts clean. Under some conditions, connectors that are not clean may result in measurement error of about 0.03 dB.

5. Advanced operation

5.1	Analysis mode	5-2
5.2	Delay	5-3
5.3	Input settings	5-5
5.4	Oscillator control	5-8
5.5	Graph display	5-12
5.6	Marker operations	5-20
5.7	Amplitude compression	5-26
5.8	Automatic high density sweep	5-29
5.9	Error correction	5-31
5.10	Differentiation and integration function	5-51
5.11	Sequence measurement	5-52
5.12	Memory operations	5-54
5.13	External reference clock	5-64
5.14	Other operations	5-66

5.1 Analysis mode

There are four possible analysis settings for data measured on two channels: (CH1/CH2), (CH2/CH1), (CH1), and (CH2). The mode is set using **【Graph】** – [ANALYSIS MODE]. Normally, the mode that is set when the instrument leaves the factory (CH1/CH2) is used.

Graph	
TITLE SET	
STYLE	SINGLE
GRID	BROKEN LINE
STYLE	X-Y1
DISPLAY MODE	
X AXIS	LOG SWEEP
Y AXIS	LIN dBR - LIN 0
DISPLAY TRACE >	MEAS Y1 Y2, REF -- --
ANALYSIS MODE	CH1/CH2
PHASE RANGE	CH2/CH1
APERTURE	CH1
SHIFT	CH2
SCALE >	

Even if the analysis mode setting is the same, the data that is displayed differs depending on the display unit setting (**【Graph】** – [DISPLAY UNIT]).

- When the display unit is GAIN

The analysis mode settings (CH1/CH2) and (CH2/CH1) differ in which channel used for the reference signal, so the display of the gain and phase is reversed. Gain is displayed as the reciprocal (inversion of sign for decibel units) and phase is displayed with inversion of sign.

When the analysis mode is (CH1) or (CH2), the voltage amplitude is displayed for each channel.

- When the display unit is IMPEDANCE

There is no difference in display, regardless of whether the analysis mode setting is (CH1/CH2) or (CH2/CH1).

When the analysis mode setting is (CH1), the input voltage amplitude is displayed for CH1. When the analysis mode setting is (CH2), the input voltage amplitude at CH2 is regarded as current amplitude and displayed. If the input to CH2 is 1 V_{rms}, it is displayed as 1 Arms (assuming that the input weighting coefficient is 1.0).

Even if the analysis mode setting is changed after the measurement has been completed, the data remains in internal memory and the data display is changed to reflect the change in analysis mode. The correspondence of analysis mode and displayed data is described in "4.6 Graph display mode settings".

5.2 Delay

If there is a response delay element in the equipment under test and the measurement frequency is changed, the transient response causes an error in the measurement data. When using this instrument to measure frequency response, that error can be reduced by inserting a delay after the frequency change and before the measurement is started. The delay duration is set according to the time constant of the equipment under test.

Particularly for equipment under test that has higher-order elements (steep filters, quartz oscillators, and other elements that have high Q values), accurate measurement cannot be performed without a large delay.

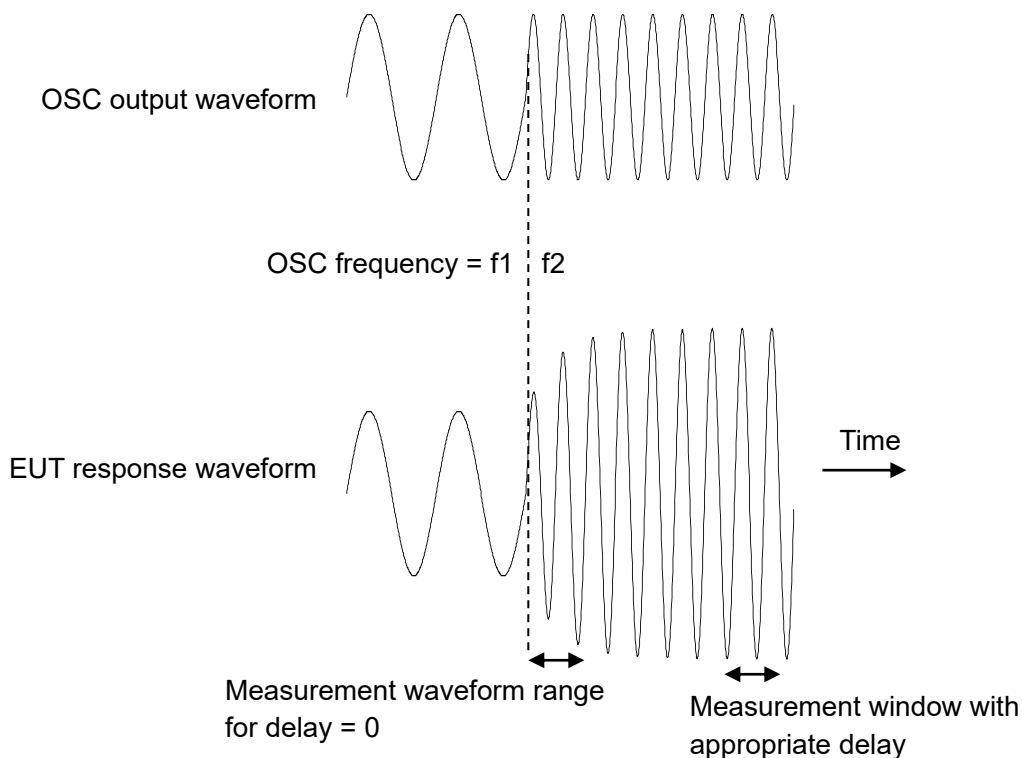

Figure 5-1 Example of a response waveform that requires a delay

The measurement frequency is changed during normal frequency sweep measurements, when the sweep begins (the frequency is returned to the starting frequency from the frequency at the end of the sweep), and in spot measurement when the measurement frequency is changed, etc. There are two delay settings: measurement delay (MEAS DELAY) and measurement start delay (START DELAY). The two types of delay differ in the timing with which the delay takes effect. Both delays are set using **【Measure】**.

Measure	
INTEGRATION MODE	FIX
INTEGRATION	1 cycle
START DELAY	0 sec
MEAS DELAY	0 sec
d/dt	OFF

【MEAS DELAY】 : The delay that is inserted each time the frequency changes during a sweep

【START DELAY】 : The delay that is inserted only at the beginning of a sweep measurement or at the beginning of a spot measurement.

■ When the delay is set in units of cycles

The measurement delay and measurement start delay are both converted to a number of cycles (time of one cycle of the measurement frequency \times the set number of cycles). Therefore, during sweep measurement, measurement is performed with different delay time depending on the measurement frequency.

5.3 Input settings

5.3.1 Measurement range

The measurement ranges for CH1 and CH2 can be set independently. The setting range is shown below.

Fixed range : 1–3 sequences in the range from 30 mV to 300 V, and 600 V

Auto-range : AUTO

The setting is done using **【Input】** – **[MEASURE RANGE]** – **[CH1]** and **[CH2]**.

The nominal values for the range are effective voltage values. The peak input voltage is about 1.4-fold of range nominal value. Also, regardless of the range, the maximum input voltage drops with frequency. For more information, refer to "3.2 Input and output connectors".



Input	
MEASURE RANGE	
CH1	AUTO
CH2	AUTO
OVER DETECT	
DETECT LEVEL	
CH1	600 Vrms
CH2	600 Vrms
ACTION	
BEEP	OFF
SWEEP	OFF
WEIGHTING FACTOR	
CH1	100.000 E-02
CH2	100.000 E-02
INVERT	OFF

Input	
MEASURE RANGE	
CH1	AUTO
CH2	AUTO
OVER DETECT	600V
DETECT LEVEL	300V
CH1	100V
CH2	30V
ACTION	10V
BEEP	3V
SWEEP STOP	1V
WEIGHTING FACTOR	300mV
CH1	100mV
CH2	30mV
INVERT	OFF

■ Fixed range

Because the range does not change during measurement, discontinuities (steps) in the measurement values from range changes do not occur. However, if pulse noise or other signals that exceed the range are included, the data will be unreliable. However, if the range is set too large, measurement error itself will also increase.

With the fixed range setting, the range is not changed automatically, even if a signal that exceeds the set range is input (including direct-current or noise, etc.). If the input signal exceeds the range, an over-level event occurs and measurement data is not obtained (not retained as numerical data).

■ Auto-range

Perform the measurements while monitoring the signal level and setting the range to find the optimum range. If noise that exceeds the range is detected, expand the range and repeat the measurements. The reliability of the obtained measurement data is high for the range does not saturate during measurement. With the auto-range setting, the instrument input circuit will not be damaged if a large signal (up to 600 Vrms) is suddenly input during operation in the high-sensitivity range.

When the signal includes a large amount of noise and a large dynamic range is needed (when the variation in signal level is large), auto-range should be used. Normally, use the auto-range setting.

5.3.2 Over-level detection

This function monitors the input signal level for CH1 and CH2 and performs operations such as sounding the buzzer when the signal exceeds the set level.

Input	
MEASURE RANGE	
CH1	AUTO
CH2	AUTO
OVER DETECT	
DETECT LEVEL	
CH1	600 Vrms
CH2	600 Vrms
ACTION	
BEEP	OFF
SWEEP	OFF
WEIGHTING FACTOR	
CH1	100 000 E-02
CH2	100 000 E-02
INVERT	OFF

} Over-level detection level

} Operation when over-level is detected

■ Setting the over-level detection level

The setting is done using **【Input】** – **[OVER DETECT]** – **[DETECT LEVEL]** – **[CH1]** and – **[CH2]**. The maximum setting value is 600 Vrms. The values can be set independently for CH1 and CH2.

When the measurement range (**MEASURE RANGE**) is set to auto-range, over detection is only possible for the frequency component measured by the instrument. Direct current, impulse noise, and frequency components other than measurement frequency are not detected. When a fixed range has been set, an input signal that exceeds the level that can be handled by that range will trigger over-level detection. The direct component and sudden spike noise will also trigger over-level detection. When measuring in environments where noise or the DC component are large, set a wide measurement range or use auto-range.

The over-level state and the non-over-level state are detected when performing measurements with this instrument. When over-level is detected, the over-level state persists until measurement is performed again, even if the input level goes to zero.

■ Setting operation for when over-level is detected

When over-level is detected, the over lamp above the CH1 or CH2 input connector on the front panel lights up. In addition to turning on the lamp, the operations listed below are possible.

- Sounding the buzzer
- Stopping measurement

The setting is done with **【Input】** – **[OVER DETECT]** – **[ACTION]** – **[BEEP]** and – **[SWEEP STOP]**. If measurement stop (– **[SWEEP STOP]**) is set to on, over-level detection stops the sweep measurement and spot measurement. If **【OSC】** – **[ON/OFF SYNC]** is set to **[SYNC]**, the oscillator output is turned off when the measurement is stopped.

■ Over-level detection and measurement data

When an over-level detection occurs, the measurement data becomes NaN (Not a Number). The frequency data for which over-level was detected is not plotted on the graph.

If an over-level is detected and measurement is stopped (**【Input】** – **[OVER DETECT]** – **[ACTION]** – **[SWEEP STOP]** is on), the data from the beginning of the sweep up to the time of the over-level detection is retained. If measurement is not stopped (– **[SWEEP STOP]** is off), the measurement data for the frequency for which over-level was detected becomes NaN. The measurement data that is stored in the USB memory device also becomes "NaN".

5.4 Oscillator control

For information on the basic settings (frequency, AC amplitude, and DC bias) and on/off control, refer to "4.3 Oscillator settings". This section explains more advanced oscillator control.

5.4.1 On/off mode

You can select between two modes for turning the oscillator output on and off. In the QUICK mode, the output is turned on or off immediately; in the SLOW mode, the output is turned on or off gradually over a period of about 10 seconds. In measurements where sudden changes in signal level are not expected, such as when measuring vibration testers or mechanical servos, select the SLOW mode. The setting is done using **[OSC] – [ON/OFF MODE]**.

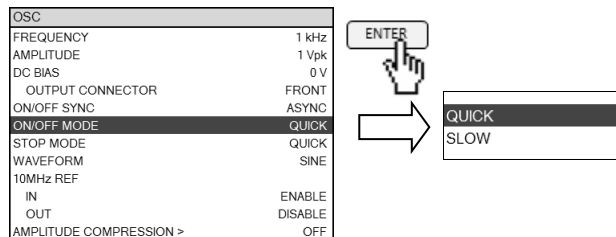

[QUICK] : Instant on or off for both AC and DC outputs

[SLOW] : Gradual change to on or off over 10 seconds for both AC amplitude and DC bias outputs

An example of operation for the SLOW setting is illustrated below.

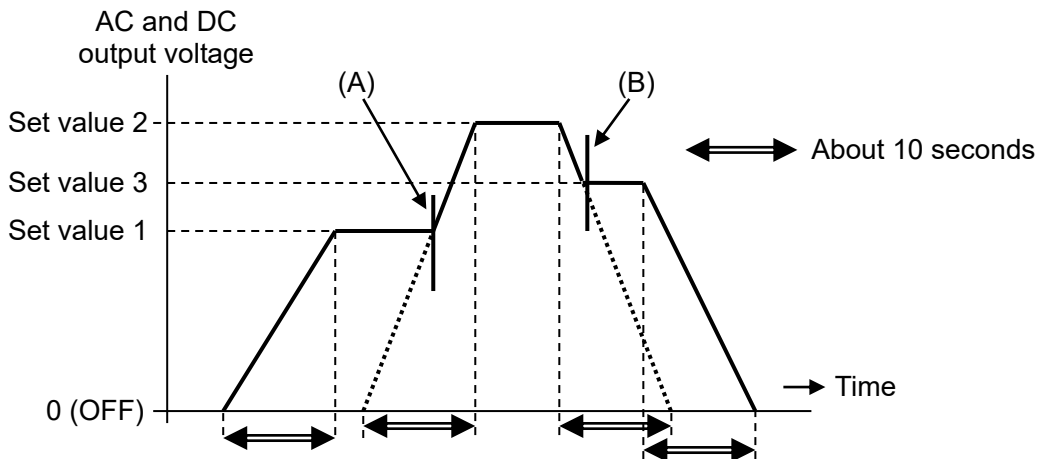
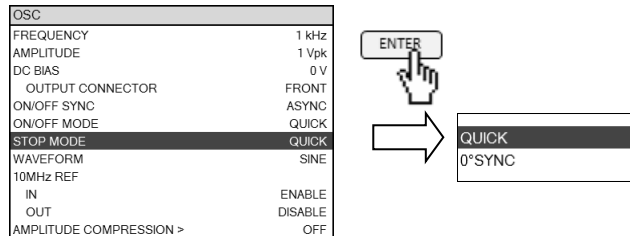

Figure 5-2 Change in output voltage for the SLOW setting

When the off state is included before and after the change, such as when changing from the output off state to the output on state or from the output on state to the output off state, the oscillator output voltage (both AC and DC) changes continuously. However, please note that when the off state is not included before and after the change (setting value 1 -> setting value 2 -> setting value 3), a discontinuous spike noise of about 10 ms is generated in the oscillator output with the timing indicated by (A) and (B) in Figure 5-2. That spike noise can be prevented by setting the output to off before changing settings and then turning the output on.

5.4.2 Oscillator stop mode

You can specify the stop (OFF) timing of oscillator output by selecting from [QUICK] and [0° SYNC]. The setting is done using **[OSC]** – [STOP MODE].



- [QUICK] : The output is turned off immediately, regardless of the signal phase.
 [0° SYNC] : The oscillator output is not turned off until it reaches 0° phase.

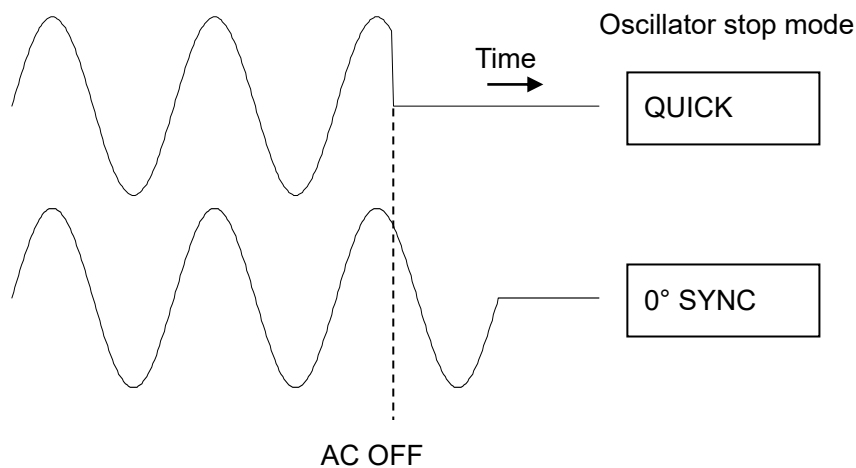

Figure 5-3 Oscillation stop mode setting and change in output voltage

The "0° SYNC" setting is used for measuring electrochemical impedance (EIS) and other such measurements. The oscillator always starts at 0° phase when turned on, so the "0° SYNC" setting means that the average voltage over the time from on to off (DC component) is zero and the total amount of electricity injected to the DUT is the same after the measurement as before the measurement.

Please note that it may take about one cycle before the output actually ceases, depending on the timing of turning the output off. (For 10 μ Hz, it will take 10^5 s \approx 28 hours to turn off in the worst case.)

Please also note that the actual oscillation stop phase may deviate from 0° if the oscillation frequency exceeds about 100 kHz.

When the oscillator stop mode is set to "0° SYNC", the SLOW setting of the oscillator on/off mode is ignored. ("0° SYNC" setting of the oscillator stop mode takes priority.) The oscillator is turned off as soon as the 0° phase timing is detected.

5.4.3 Frequency change mode

The timing for changing the frequency during a sweep measurement and the timing for changing the frequency when the frequency setting is changed can be selected as [0° SYNC] or [ASYNC]. The setting is done with **[Sweep] – [STOP MODE]**.

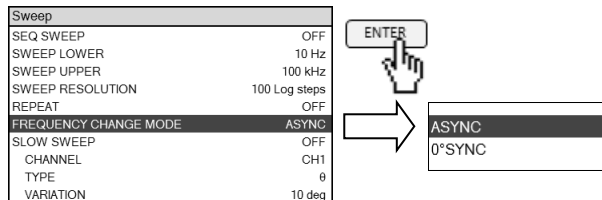

[ASYNC] : The frequency is changed immediately, regardless of the signal phase.

[0° SYNC] : The frequency is not changed until the oscillator output signal reaches 0° phase. The average voltage of the DC component from the beginning of the frequency sweep to the end of the frequency sweep is zero.

Please note that it may take one cycle before the frequency actually changes, depending on the timing of the frequency change. (For 10 μ Hz, it will take 10^5 s \approx 28 hours to switch in the worst case.)

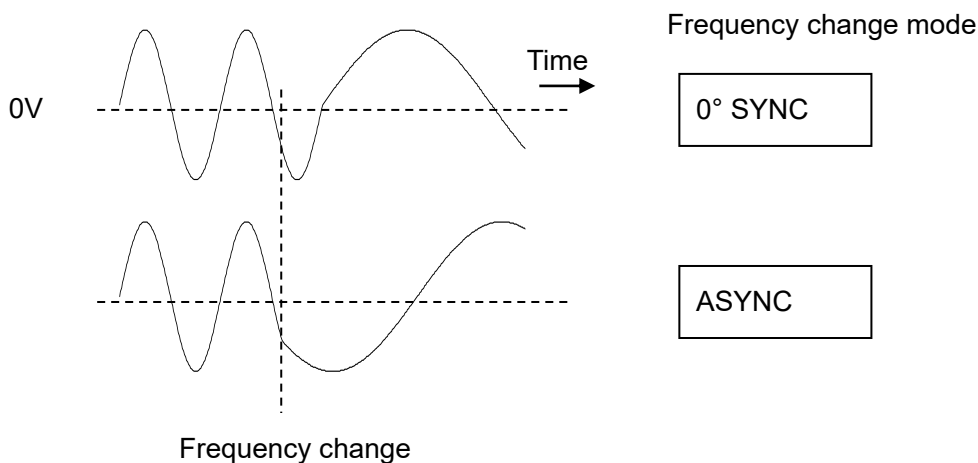

Figure 5-4 Frequency change mode and waveform change

The "0° SYNC" setting is used for measuring electrochemical impedance (EIS) and other such measurements. The total amount of electricity injected to the DUT is the same before and after the sweep measurement.

Please note that the actual frequency switching may deviate from the 0° phase if the oscillation frequency exceeds about 100 kHz.

5.4.4 Measurement synchronization

This function automatically turns the oscillator output off when the measurement is completed. The setting is done with **[OSC]**– **[ON/OFF SYNC]**. This function is used when it is not desirable for the measurement signal to be applied to the equipment under test for a long period of time.

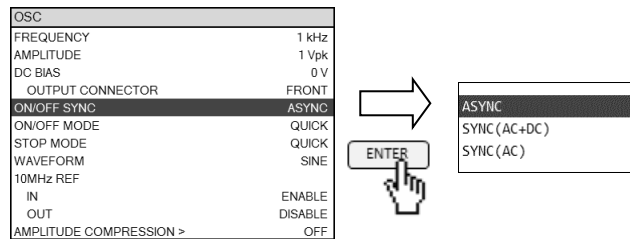

[ASYNC] : The oscillator output is not turned off, even when the measurement is completed.

[SYNC] : The oscillator output is turned off when the measurement is completed.

The order of operations for when the setting is SYNC is shown below.

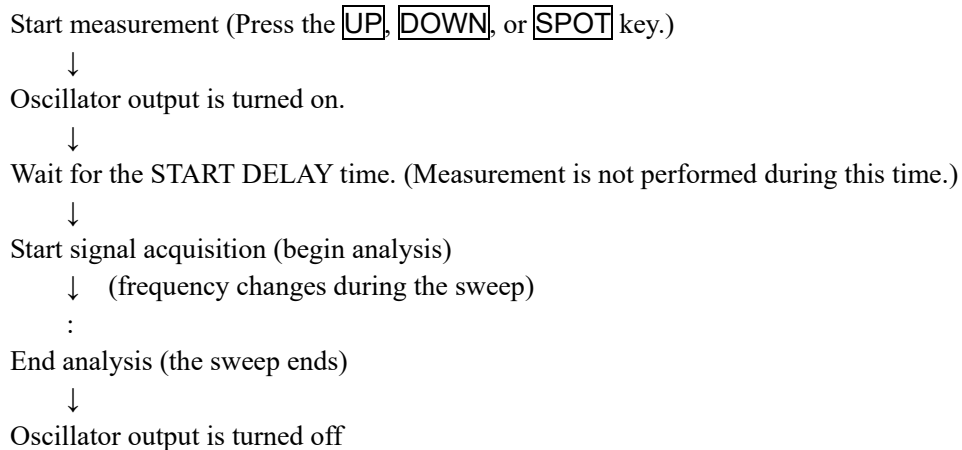

5.5 Graph display

5.5.1 Setting the title

Set the title text for the data that is being displayed. The text that is set is displayed at the top of the graph.

When the data is saved to internal or external memory, the title is also included.

The title text is set with **[Graph]** – [TITLE SET]. Up to 32 characters can be input.

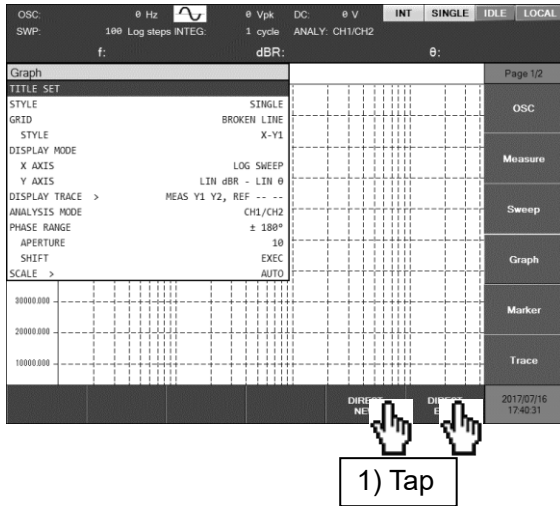

2) Enter the title

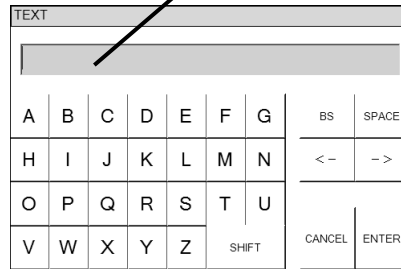

5.5.2 Setting the graph style

There are two display styles for graphs: SINGLE and SPLIT. The style is set by using **[Graph]** – [STYLE].

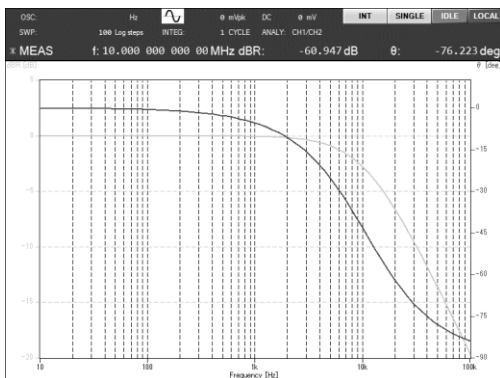
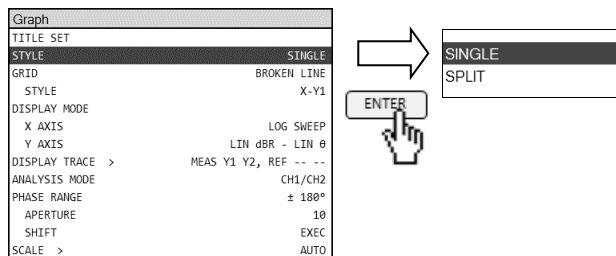

SINGLE display

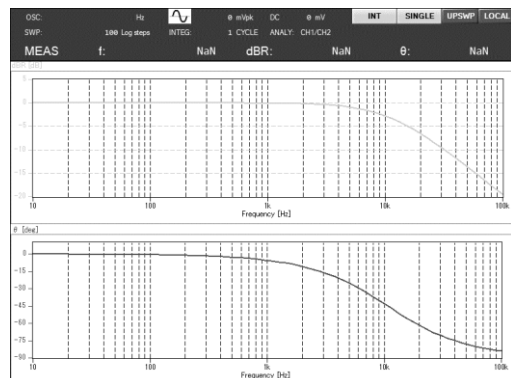

SPLIT display

Figure 5-5 Graph display styles

■ SPLIT display restrictions

When a Nyquist plot or a Cole-Cole plot is displayed with the SPLIT graph display style, a small graph is displayed in the upper half of the screen and the lower half is empty. The SPLIT style should only be used for Bode plots; for all other diagrams, use the SINGLE display style.

5.5.3 Grid display

This function displays a grid on the graph. The setting is done with **[Graph]** – [GRID] or – [STYLE].

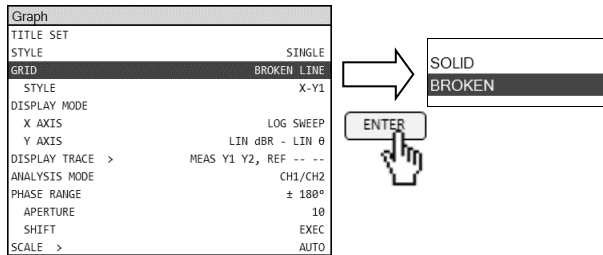

[GRID] : This selects the type of grid line.

- [SOLID] Solid grid lines
- [BROKEN] Broken grid lines

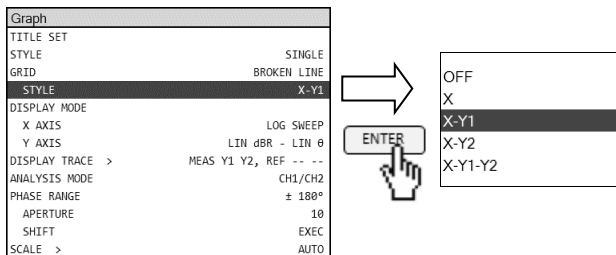

[STYLE] : This selects what axis the grid display setting applies to.

- [OFF] No grid display
- [X] The grid is displayed only for the X axis.
- [X-Y1] The grid is displayed for the X axis and the Y1 axis.
- [X-Y2] The grid is displayed for the X axis and the Y2 axis.
- [X-Y1-Y2] The grid is displayed for the X axis, Y1 axis, and Y2 axis.

5.5.4 Trace operation

The graphing function of this instrument can display two types of traces, MEAS TRACE and REF TRACE. Each trace can have Y1 data and Y2 data, which can each be set individually to be displayed or not displayed. Data that is obtained by measurement is stored in MEAS TRACE data and that data is overwritten each time a measurement is performed. REF TRACE data, on the other hand, is retained unless explicitly removed or changed. With reference data displayed in REF TRACE, measurement data can also be plotted at the same time for comparison.

■ Copying MEAS TRACE to REF TRACE

To copy the measurement data (MEAS TRACE) to REF TRACE, select **[Trace]** – **[MEAS COPY]**, and tap on the **[REF TRACE]** function key. The copy completed message will be displayed for a short time.

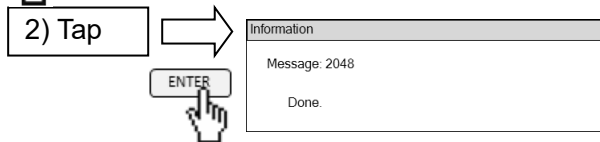
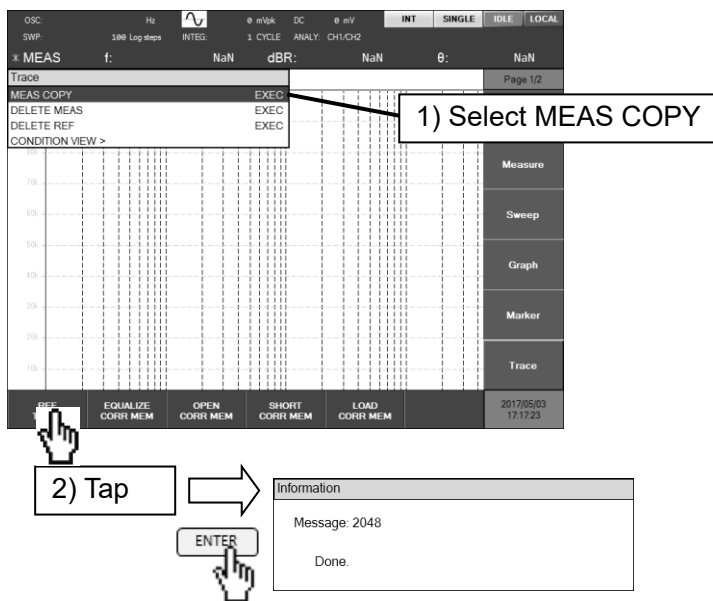

The copying can also be accomplished by selecting **[MEAS COPY]**, pressing the **[ENTER]** key, selecting **[REF TRACE]** from the list box that is displayed, and then pressing the **[ENTER]** key again.

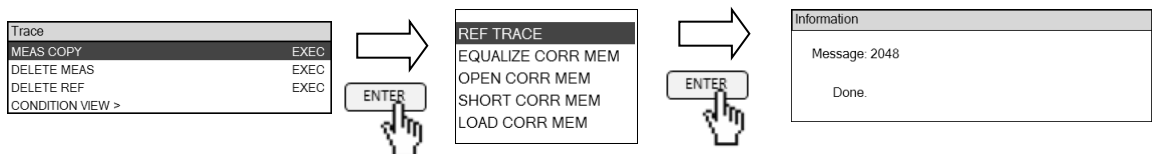

■ Deleting a trace

The data for the respective traces can be deleted with **[Trace]** – **[DELETE MEAS]** and **[DELETE REF]**. Deleted data cannot be recovered, so perform this operation with care.

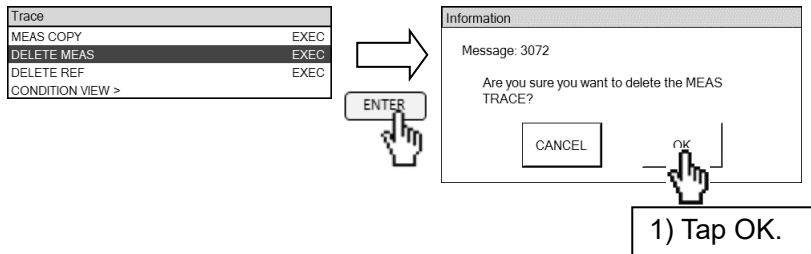

■ Displaying and hiding traces

To set a trace to be displayed or not displayed (hidden), select **[Graph]** – **[DISPLAY TRACE]** and tap on the function key. The second line in the label for each function key indicates the action that will be performed when the key is tapped. While a trace is being displayed, **[OFF]** is shown on the second line of the function key for that trace. If you tap the function key in that state, the corresponding trace will be hidden and the second line of that function key will change to **[ON]**. Even though the trace is not being displayed, the data remains. By tapping a function key whose secondline is displayed **[ON]**, the corresponding trace will be displayed again.

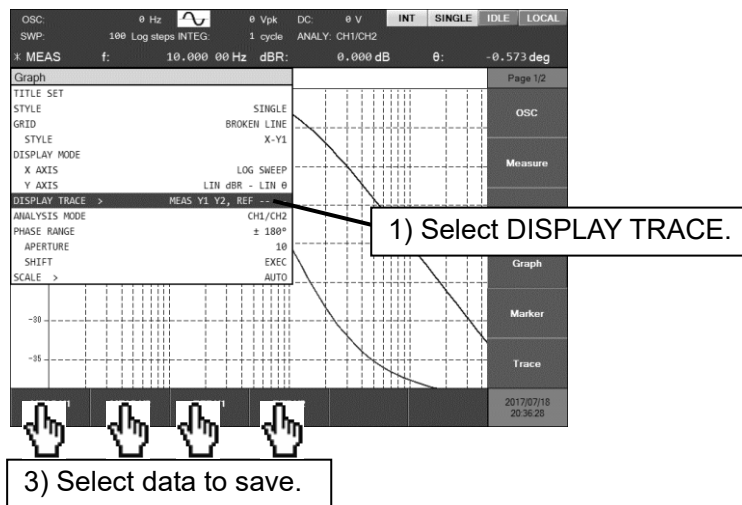

Another way to switch a trace on / off is to select **[Graph]** – **[DISPLAY TRACE]** and push the **[ENTER]** key. Then a list box will appear.

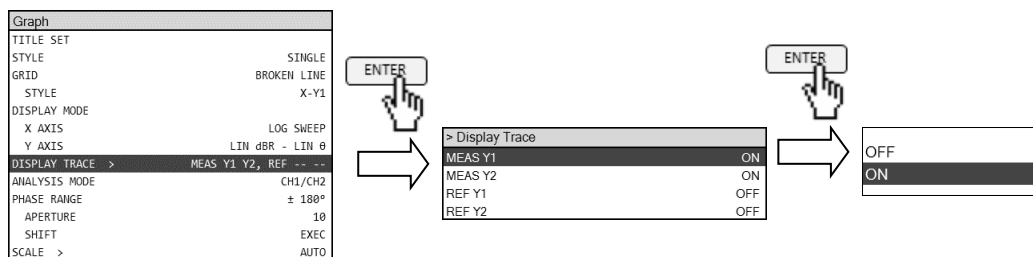

5.5.5 Phase display

This function sets the display range for phase. The setting is done with **[Graph]** – **[PHASE RANGE]**.

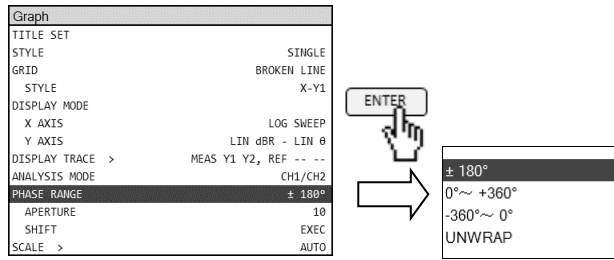

- $[\pm 180^\circ]$: Phase is displayed within the range of $-180^\circ \leq \theta < +180^\circ$.
- $[0^\circ \text{ to } +360^\circ]$: Phase is displayed within the range of $0^\circ \leq \theta < +360^\circ$.
- $[-360^\circ \text{ to } 0^\circ]$: Phase is displayed within the range of $-360^\circ < \theta < 0^\circ$.
- [UNWRAP] : Phase is displayed with unwrapped. The phase can also exceed $\pm 360^\circ$.

The phase value itself does not change, regardless of the setting. For example, the phase that is -90° when the setting is $\pm 180^\circ$ is displayed as $+270^\circ$ when the setting is 0° to $+360^\circ$, but the phase angle itself is the same.

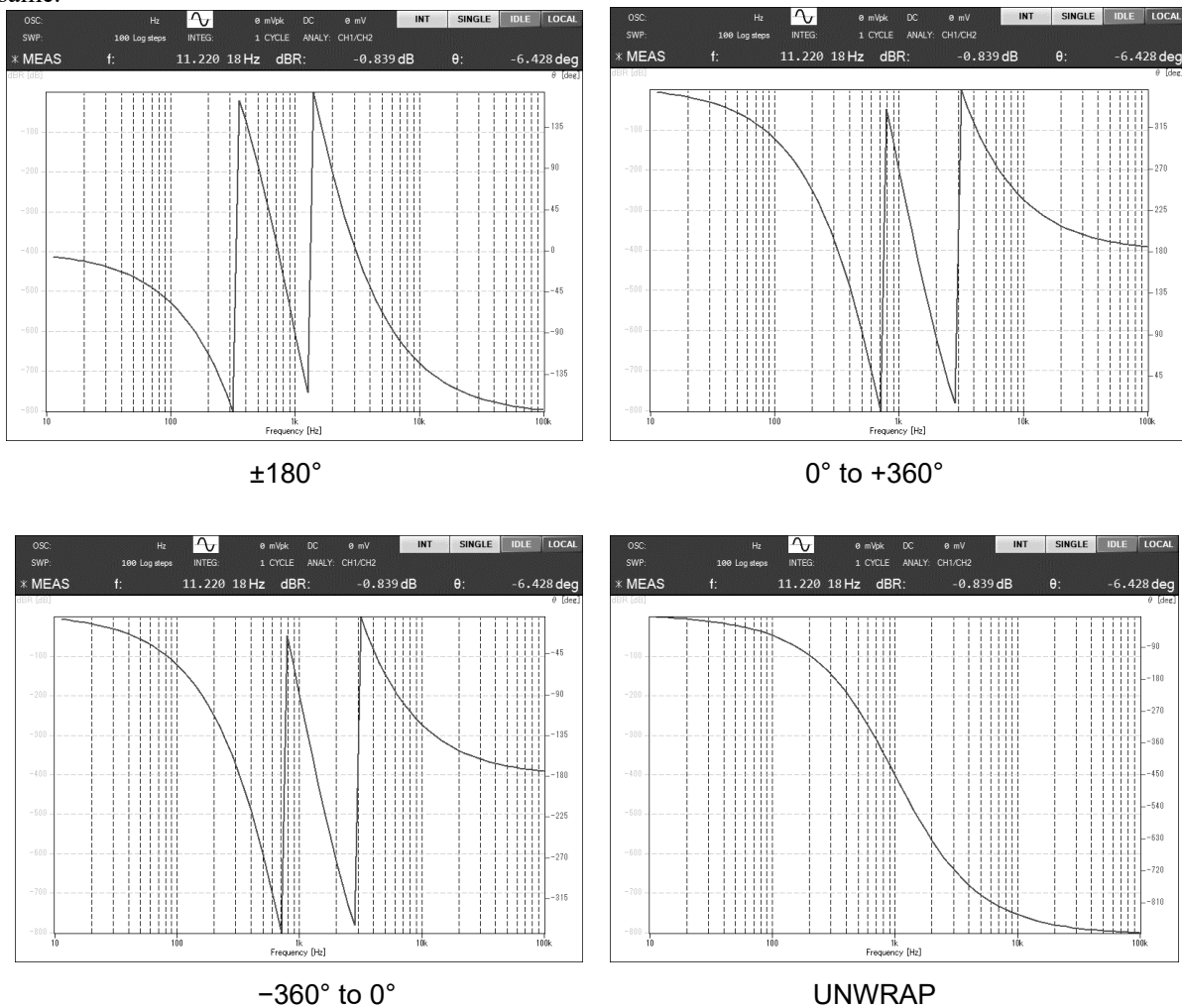

Figure 5-6 Example of phase measurements

■ The unwrapped phase display function

For the [UNWRAP] display setting, unwrapped phase display is performed, with the phase measurement value at the sweep starting frequency (the lower-limit frequency for an up-sweep or the upper-limit frequency for a down-sweep) as the reference value. Thus, when DUTs that have entirely the same phase characteristics are measured by up-sweep or down-sweep measurement, the results are displayed in graphs that differ in phase by an integer multiple of 360° .

■ The 360° phase shift function

To display the currently-displayed phase data as a graph with 360° added or subtracted, select **[Graph]** – **[PHASE RANGE]** – **[SHIFT]** and tap on either of the function keys labeled **[+360°]** or **[-360°]**. This is used when a phase value in a phase continuous display is too large. When the phase display range setting is anything other than [UNWRAP], the display is not changed.

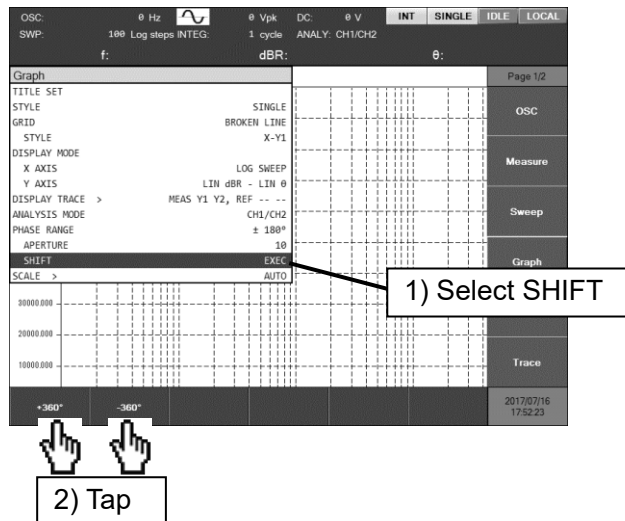

■ The aperture setting

【Graph】 – [PHASE RANGE] – [APERTURE] is the value for the width of the moving average window of the phase characteristic for the group delay display.

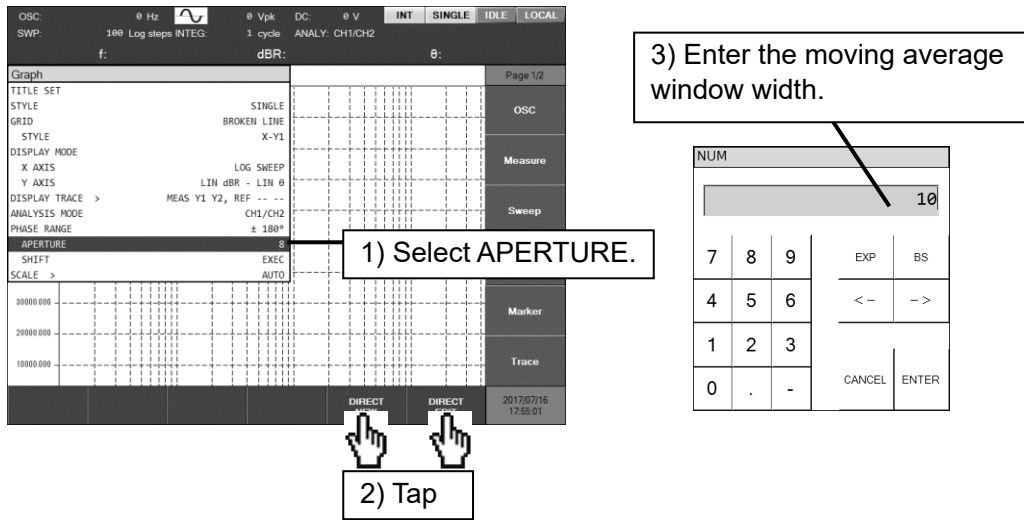

Larger values for the setting reduce noise and produce a smooth group delay characteristic, but abrupt changes are not represented. The aperture is set to an even number that is less than the number of frequency points in the sweep (but no more than 200). Set a value that is appropriate for the equipment under test.

The effect of the aperture setting on the group delay characteristic of the bandpass filter for communication is shown in the figure below, where the upper parts of the figures show the gain characteristics and the lower parts show the group delay characteristics. We can see that higher aperture settings result in a smoother group delay characteristic and that the gain characteristic is not affected.

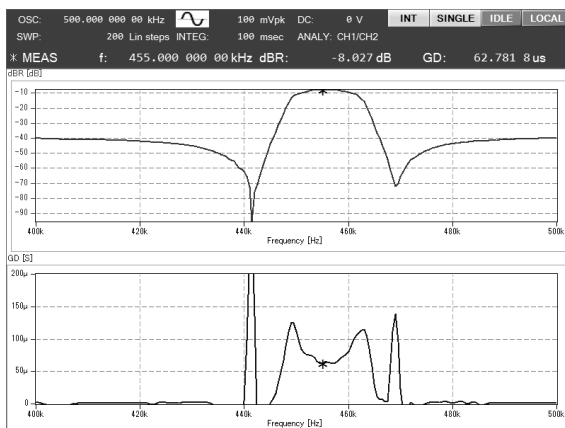

Aperture setting = 2

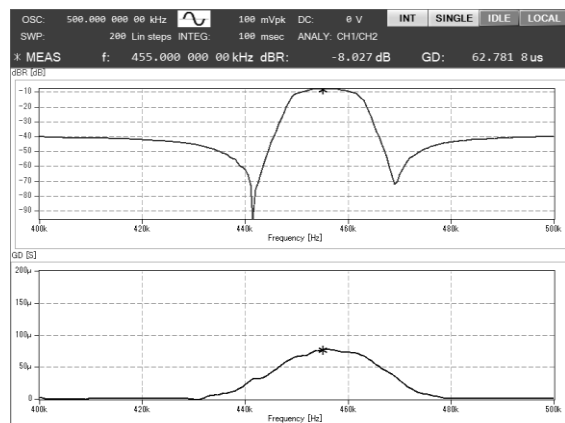

Aperture setting = 20

5.5.6 Setting the scale

This setting determines the range of the graph X, Y1, and Y2 axes. Usually, the AUTO setting is convenient, because the ranges are adjusted automatically to suit the data that is being displayed. The FIX setting allows the display range to be set to an arbitrary value. The setting is done using **【Graph】** – **[SCALE]** – **[MODE]**.

If you select an item other than **[MODE]** in **【Graph】** – **【SCALE】**, a button for setting the graph axis range is displayed on the function keys. In addition to specifying a numerical value directly, it is possible to set a graph range that matches the data range that is being displayed. For more information on using the function keys, refer to "3.5.4 Graph dialog".

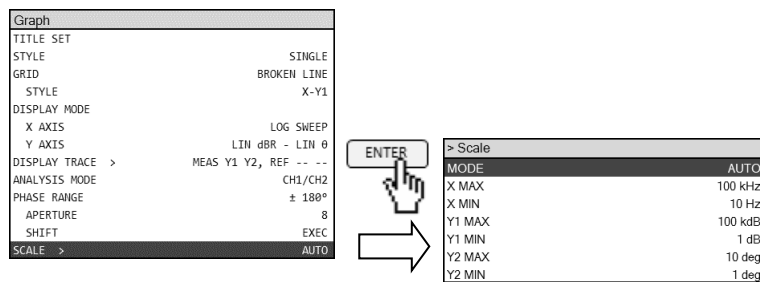

5.6 Marker operations

You can display a marker on the graph and read the corresponding measurement value. The marker value is displayed as the number in the marker display area at the top of the graph. Markers can be moved by using the knob on the front panel and the data that is specified by the marker can be selected by using the two keys (**ACTIVE** and **ΔSET**) that are located below the knob.

For a description of the basic Marker operations, refer to "3.1 Function and use of each part of the panels" and "3.5.5 Marker dialog".

■ Main marker and delta marker

The two types of markers are main markers and delta markers. The type of marker to use can be set with **[Marker]** – **[MARKER]**.

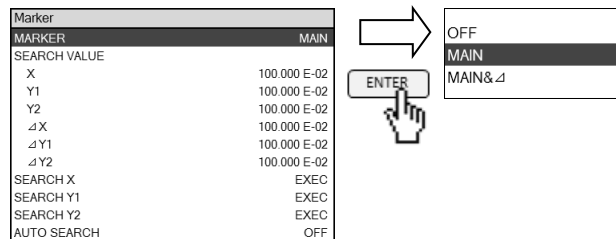

The main marker is for reading a data value and the delta marker is for displaying the difference in value relative to the main marker. The main marker is indicated by an asterisk (*) on the graph and the delta marker is indicated by the delta symbol (Δ).

In the upper part of the graph, the currently active marker and its data value are displayed.

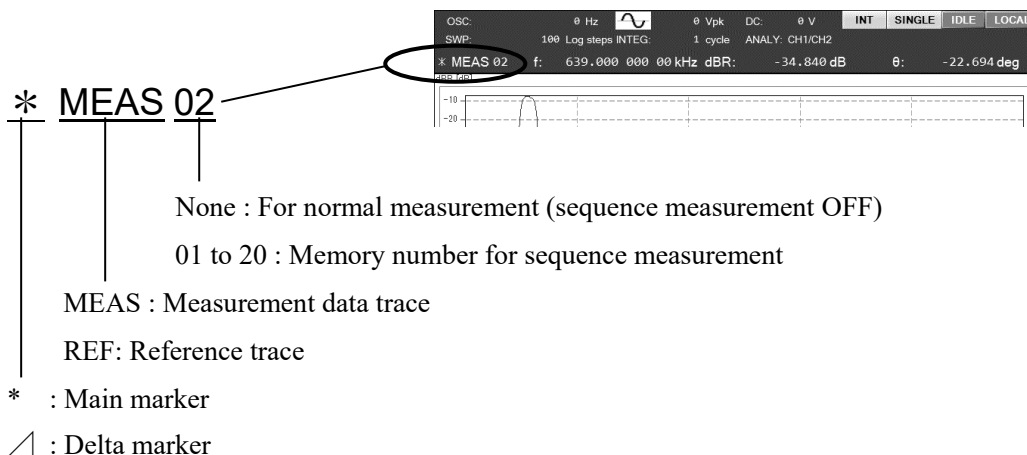

To change the trace that the marker currently refers to, use the **ACTIVE** key; to toggle between the main marker and the delta marker, use the **ΔSET** key. When the delta marker is selected, the **ΔSET** lamp lights up.

■ Marker search function

In addition to using the knob to manually move the marker and read data values, it is possible to perform an automatic search for locations that match specified conditions. The search conditions include maximum value (MAX), minimum value (MIN), specified value (VALUE), maximal value (PEAK), and minimal value (BOTTOM). The conditions can be specified individually for the X axis, Y1 axis, and Y2 axis. For the value, peak, and bottom conditions, it is also possible to search for the next candidate (NEXT) or the previous candidate (PREV). The marker search setting is done with **[Marker]**– **[SEARCH VALUE]** or **– [SEARCH X]**, or **– [SEARCH Y1]** or **– [SEARCH Y2]**. For more information on the setting items, refer to "3.5.3 Marker dialog".

Marker	
MARKER	MAIN
SEARCH VALUE	
X	100.000 E-02
Y1	100.000 E-02
Y2	100.000 E-02
ΔX	100.000 E-02
ΔY1	100.000 E-02
ΔY2	100.000 E-02
SEARCH X	EXEC
SEARCH Y1	EXEC
SEARCH Y2	EXEC
AUTO SEARCH	OFF

Set the search value

Execute the search

The marker search locations for when the graph X axis is frequency (bode plot) are illustrated in Figure 5-7.

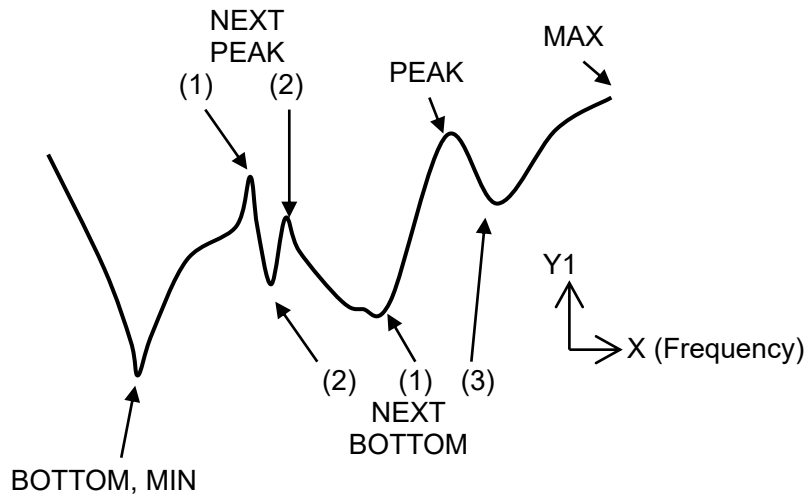

Figure 5-7 Example of marker search (Bode plot, MAX / MIN / PEAK / BOTTOM)

The marker search locations after the value search has been performed are illustrated in Figure 5-8. This example is for the Y1 value search, but it also applies to Y2 values.

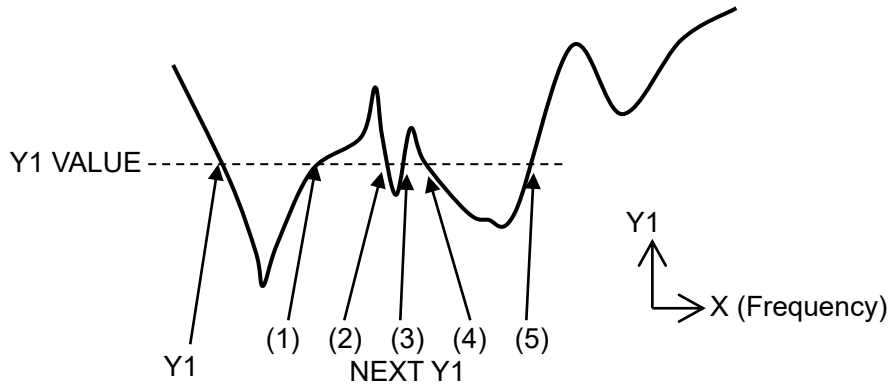

Figure 5-8 Example of marker search (Bode plot, Y1 VALUE)

The locations from $\Delta Y1$ and $\Delta Y2$ marker search are illustrated in Figure 5-9.

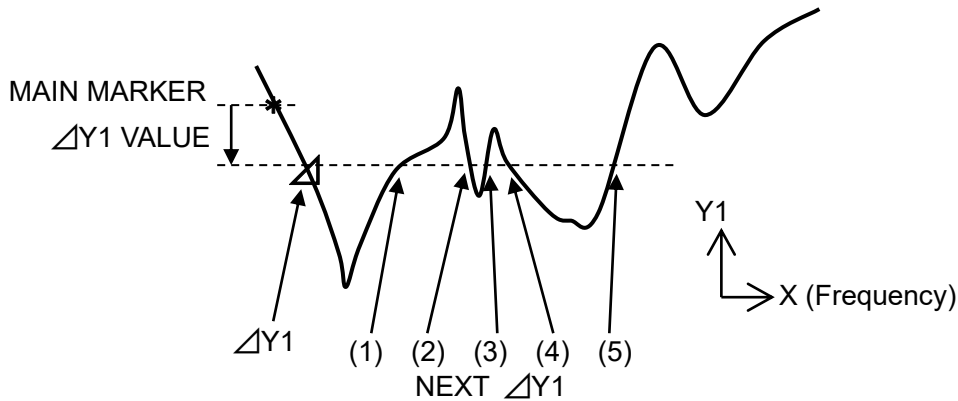

Figure 5-9 Example of marker search (Bode plot, $\Delta Y1$ VALUE)

For graphs that can have multiple Y values for an X value, such as a Nyquist plot or a Cole-Cole plot, the X axis is also searched for PEAK / BOTTOM / ΔX .

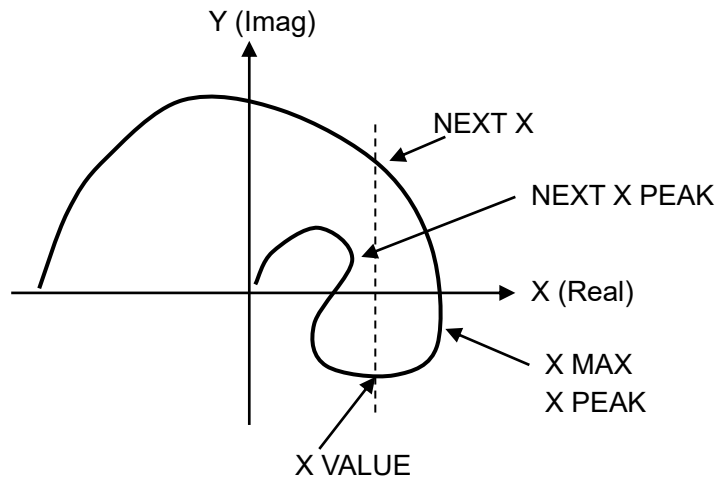

Figure 5-10 Example of marker search (Nyquist plot, X MAX / PEAK / VALUE)

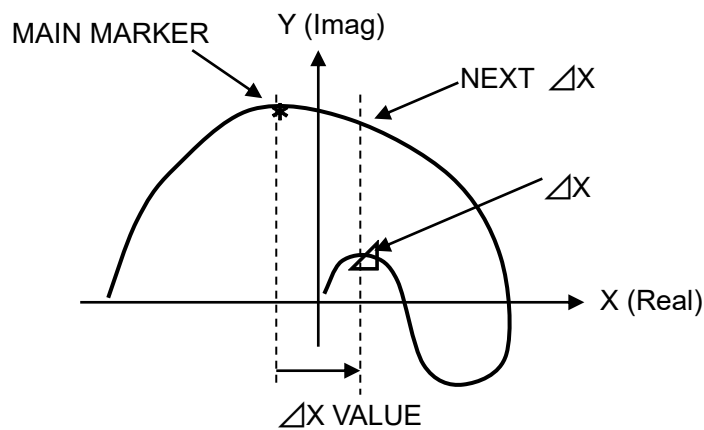
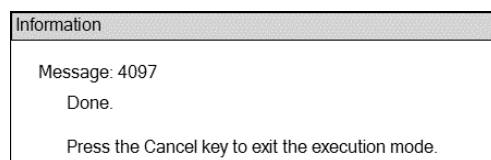

Figure 5-11 Example of marker search (Nyquist plot, ΔX)

A PREV search moves the marker in the reverse order of a NEXT search.

■ Marker search procedure

- (1) When performing a value search, set the value in the parameters of **【Marker】** – [SEARCH VALUE].
- (2) Select from among [SEARCH X], [SEARCH Y1], and [SEARCH Y2] to set the target for the search.
- (3) Tap on the search item of the function key. There are multiple items for Y1 and Y2. Scroll the function key [1/4 ⇒] to [4/4 ⇒] to display the search items and tap on the search item key for your search.
- (4) The marker will move and a search completed message will be displayed for a short time.



- (5) The function key display will remain, so it is possible to perform another search. When you have finished searching, press the **CANCEL** key.

■ About the data position indicated by the marker

The marker moves only to the position of frequency data that has actually been measured. Marker search also only finds measured frequencies, and the marker is moved to the frequency data that is closest to the search conditions. Accordingly, you should note that the marker position that results from the search is not usually exactly the same as the search value that was set. For a more accurate reading of the marker value, increase the sweep resolution (increase **【Sweep】** – [SWEEP RESOLUTION]) and perform the measurement again.

■ Automatic marker search when a sweep is completed

It is possible to register the marker search settings in advance so that the marker search can be performed automatically when a sweep measurement is completed. Select the search item with **[Marker]** – **[AUTO SEARCH]**. If set to **[OFF]**, the search is not automatically performed.

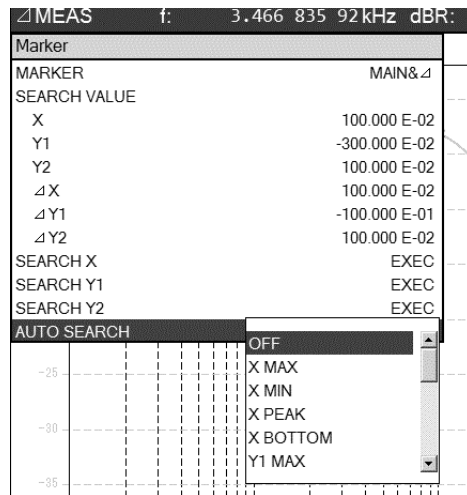

The search method is the same as for manual search, but it is not possible to set the NEXT and PREV operations.

Practical examples of automatic search are presented below.

(Example 1) : Automatic search for the low-pass filter cutoff frequency

Automatic search for the low-pass filter cutoff frequency is set to assuming a DC gain of 0 dB.

- Set **[SEARCH VALUE Y1]** to -3.0 .
- Set **[AUTO SEARCH]** to **[Y1]**.

When a sweep is completed, the marker is automatically moved to the frequency for -3 dB. This is convenient for adjusting the filter cutoff frequency. If the DC gain is other than 0 dB, sets those search value for (DC gain -3 dB).

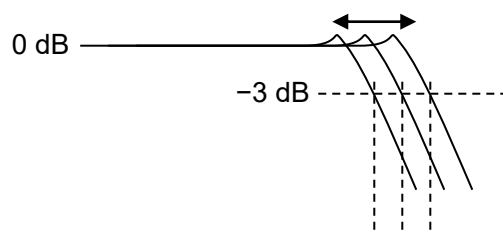

Example of search for the -3 dB frequency.

If the search item is set to **PEAK**, the search is performed for the peak frequency of a bandpass filter (BPF); if set to **BOTTOM**, the search is performed for the bottom frequency of a notch filter (and elimination filter).

(Example 2) : Automatic search for the phase margin of a negative feedback loop

In a feedback loop, the frequency for which the pass gain is 0 dB is the loop bandwidth. The phase at that frequency is the phase margin.

- Set [SEARCH VALUE Y1] to 0.0.
- Set [AUTO SEARCH] to [Y1].

When the sweep measurement is completed, the marker is automatically moved to the frequency for which the gain is closest to 0 dB. The frequency and phase of the marker position correspond to the loop and phase margin.

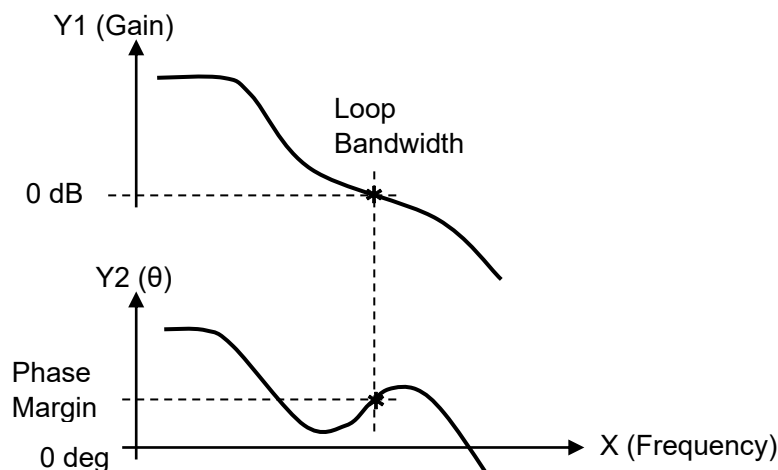

(Example 3): Measuring the self-resonant frequency of an inductor

Set the display units to IMPEDANCE and measure the impedance characteristic of the inductor DUT (set the Y1 axis to Z and set the Y2 axis to θ).

- Set [AUTO SEARCH] to [Y1 PEAK].

When the sweep is completed, the marker moves to the maximum Z value. The marker frequency is the self-resonant frequency. The resonance frequency may be the frequency for which the phase is 0° .

In that case, set the value is as shown below.

- Set [SEARCH VALUE Y2] to 0.0.
- Set [AUTO SEARCH] to [Y2].

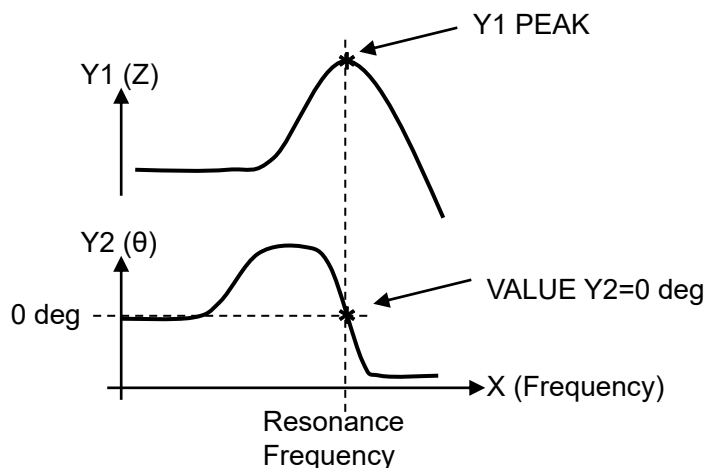

5.7 Amplitude compression

This function automatically controls the amplitude of the oscillator signal applied to the equipment under test. By correcting for the frequency characteristics of the system being measured, measurement can be performed with a constant amplitude applied to the DUT.

As illustrated in Figure 5-12, this instrument can automatically adjust the oscillator amplitude so that the amplitude of the output of the equipment under test (EUT) A1 remains constant for the measurement, regardless of the frequency characteristics of A1.

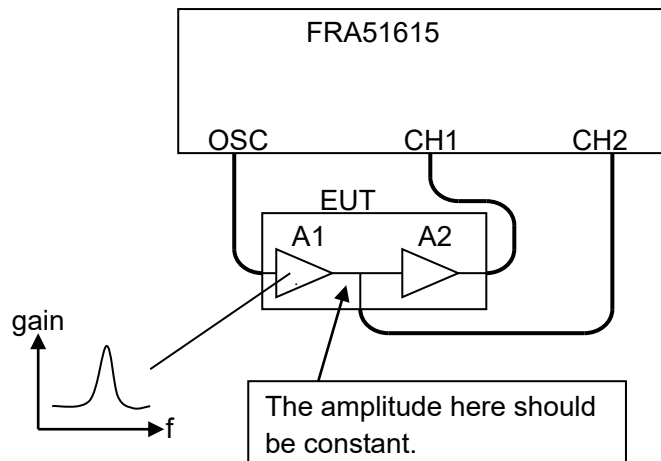

Figure 5-12 Example of using amplitude compression (gain-phase measurement)

An example of measuring impedance is illustrated in Figure 5-13. Regardless of the frequency characteristics of the DUT or EUT, the measurement can be performed with a constant voltage amplitude applied to the DUT itself. If amplitude control is performed for the output of CH2, measurement can be performed at constant current.

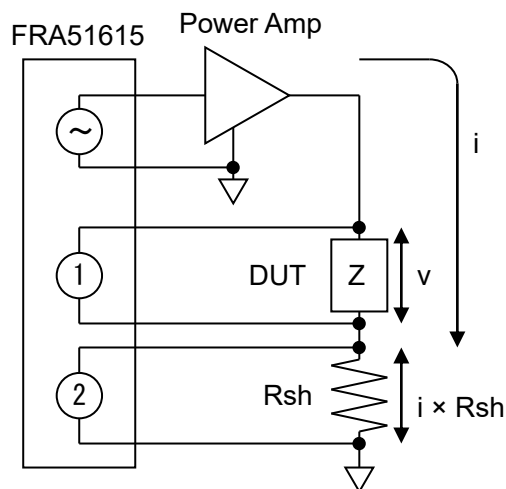

Figure 5-13 Example of using amplitude compression (impedance measurement)

The internal operation of this instrument for amplitude compression is described below.

- 1) Measurement is performed once with the oscillator output voltage at the value that is currently set.
- 2) The amplitude measured at the reference channel [REF CHANNEL] is compared with the target amplitude [REF LEVEL]. If the result is within the permissible error [TOLERANCE], the measurement at the current frequency is ended.
- 3) If the permissible error is exceeded, a new oscillator amplitude is calculated from the error. (The amplitude setting is changed.)
- 4) The measurement is performed again and the results are compared with the target amplitude. If the permissible error is exceeded, the amplitude setting is reset again and the measurement is repeated.
- 5) If the maximum number of retries [RETRY TIMES] is exceeded, it is treated as an error and the measurement at the current frequency is ended.
- 6) The measurement result is output.

To protect the equipment under test when the oscillator output voltage is changed in the step three above, it is possible to set the maximum amplitude [OUTPUT LIMIT] (voltage control).

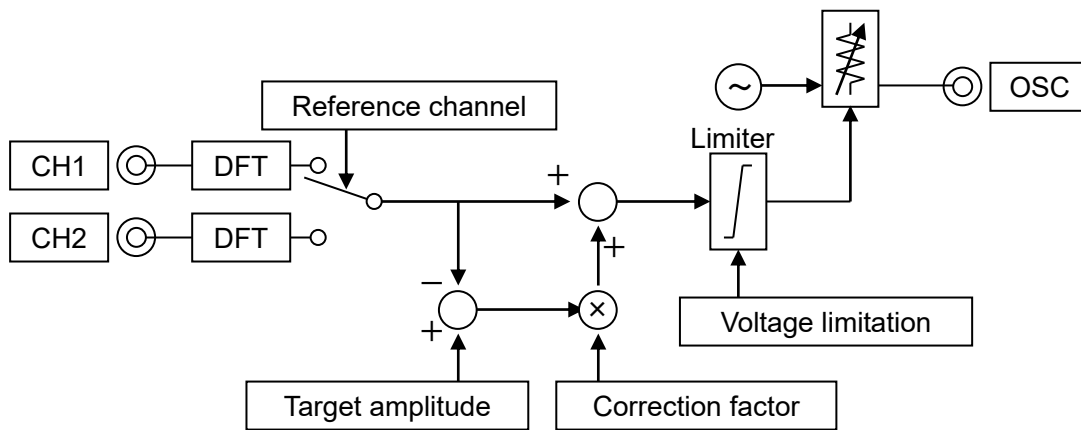
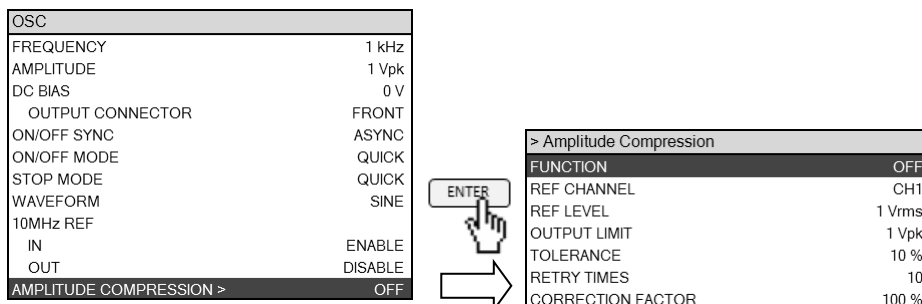

Figure 5-14 Operation for amplitude

The amplitude setting is done with **[OSC]** – [Amplitude Compression].



- [FUNCTION] : Set to ON to use the amplitude compression function.
- [REF CHANNEL] : Set the channel for amplitude monitoring (reference channel).
- [REF LEVEL] : This is the target for amplitude control. Amplitude control is performed so

that the measured value of the reference channel has this value.

- [OUTPUT LIMIT] : This is the maximum amplitude of the oscillator (output control).
[TOLERANCE] : This is the permissible error of the target level.
[RETRY TIMES] : The maximum number of times the process is repeated.
[CORRECTION FACTOR] : This is the correction factor.

For the parameter setting ranges, etc., refer to "3.5.1 OSC dialog".

■ The correction factor

The correction factor [CORRECTION FACTOR] is set for measurements where sudden changes in amplitude are not desired or when measuring DUTs for which the gain varies with the signal level (DUTs that have strong nonlinearity). The correction factor corresponds to the gain adjustment of an automatic control loop that includes the equipment under test. If the amplitude control is unstable (divergent), reduce the correction factor to a small value.

■ About the oscillator amplitude after amplitude compression

When you use the amplitude compression function, the oscillator amplitude setting (【OSC】 – [AMPLITUDE]) also changes to accord with the adjusted amplitude. Please note that the value does not return to the amplitude value that had been set prior to the amplitude compression, even if the amplitude compression function is turned off. (The changed amplitude value is the final value.)

■ If amplitude control is not possible

If the result is not within the permissible error, even if the maximum number of retries is exceeded, and an amplitude setting that exceeds the output amplitude control value is needed, the amplitude control fails, but the measurement data is still obtained. For a sweep measurement, the amplitude control is attempted again at the next frequency.

5.8 Automatic high density sweep

This function automatically increases the density of sweep measurement only in the vicinity of large changes in measurement data. By increasing the measurement resolution only where necessary, accurate results can be obtained in a short time.

This function compares the measurement value difference between adjacent measurement points $|d_n - d_{n-1}|$ (d_n is the measurement data at frequency f_n) with the threshold value [VARIATION]. When exceeding the threshold value, a new measurement point is inserted between f_{n-1} and f_n and a measurement is performed at that new point. In this way, frequency density is increased automatically until measurement value differences fall below the threshold. After the frequency f_n , the sweep density returns to the normal value.

An example of an automatic high density sweep measurement of the resonance characteristic of a crystal resonator is shown in Figure 5-15, where the black dots (●) indicate the measurement data points. We can see that the density of the frequency sweep is automatically made high only in the part where there is a sudden change in the characteristic.

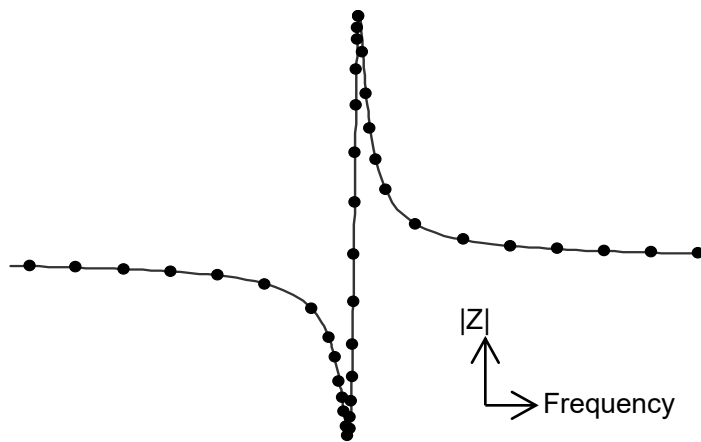

Figure 5-15 Example of measurement using the automatic high density sweep

The automatic high density sweep is set with **【Sweep】** – [SLOW SWEEP].

Sweep	
SEQ SWEEP	OFF
SWEEP LOWER	10 Hz
SWEEP UPPER	100 kHz
SWEEP RESOLUTION	100 Log steps
REPEAT	OFF
FREQUENCY CHANGE MODE	ASync
SLOW SWEEP	OFF
CHANNEL	CH1
TYPE	θ
VARIATION	10 deg

[SLOW SWEEP] : This is set to ON to perform automatic high density sweeping. For normal sweep measurement, this is set to OFF.

[CHANNEL] : This sets the channel for monitoring sudden changes.

[TYPE] : This sets the parameter to be monitored.

[VARIATION] : This is the parameter change threshold. If the amount of change relative to the measurement at the previous frequency exceeds the value set here, it is judged to be a sudden change and the automatic high density sweep is performed.

The parameter setting ranges and other such information is described in "3.5.3 Sweep dialog".

■ Example of automatic high density sweep setting

Typical examples of measurements for which the automatic high density sweep function is convenient are measurements of the resonance characteristics of piezoelectric resonators and crystal resonators. In such measurements, the phase θ changes suddenly near the resonance frequency. Accordingly, automatic high density measurement only in the vicinity of the resonance frequency is possible if the monitoring parameter [TYPE] is set to phase θ . Because phase is being monitored, the monitoring channel can be set to either CH1 or CH2 and the operation is the same.

The change threshold value [VARIATION] can be initially set to about 10° and adjusted as necessary. Setting this to a small value produces high density results, but the measurement time is long.

■ Monitoring parameters and reference channel

When the monitoring parameter [TYPE] is dBR or θ , the operation is the same whether the reference channel is set to CH1 or CH2, because the quantity is determined by the measurement data between the two channels.

When the monitoring parameter [TYPE] is R, a, or b, the measurement data (amplitude value, V_{rms}) of the channel that is set as the reference channel is monitored. Even if the analysis mode setting (**【Graph】** – [ANALYSIS MODE]) is CH1/CH2 or CH2/CH1, the amplitude (V_{rms}) is monitored rather than the gain (ratio).

■ Cautions concerning automatic high density sweep measurements

Setting [VARIATION] to a smaller value than is necessary will increase the number of frequency points. If the maximum number of measurement points for this instrument (20,001) is exceeded, the error message "-3072" is displayed and the sweep measurement is ended at that time. Please take note of this, because the measurement ends without reaching either the upper measurement frequency limit or the lower measurement frequency limit. For more information on the error message, refer to "7.1 Error messages".

5.9 Error correction

The error correction function of this instrument is explained here.

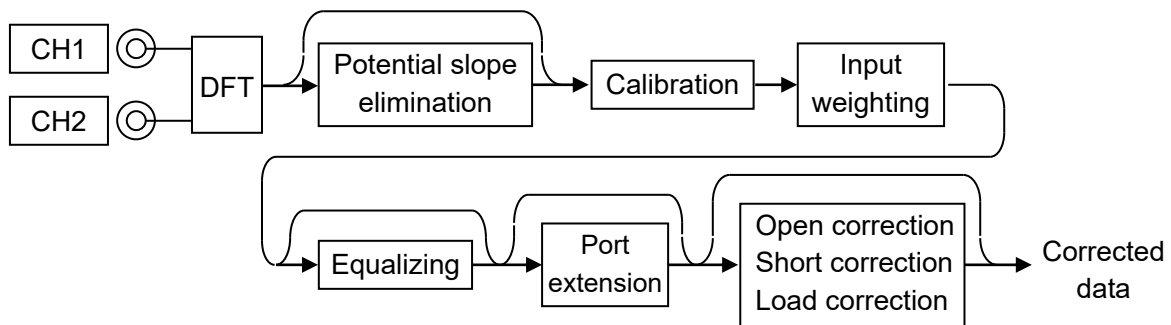

Figure 5-16 Error correction data flow

The type of correction that is used varies with the type of measurement (display unit).

- Error correction functions for all types of measurements
 - Calibration The error of the instrument itself is corrected.
 - Input weighting The attenuation of probes, etc. is corrected.
- Error correction functions for gain-phase measurements
(Should be turned off for impedance measurement)
 - Equalizing The frequency characteristics of externally-connected cables, probes, and amplifiers, etc. are corrected.
- Error correction functions for impedance measurements
(Should be turned off for gain-phase measurement)
 - Potential slope elimination This removes the effects of changes in electrical potential and the charging and discharging of batteries, etc.
 - Port extension This corrects for errors caused by characteristic impedance or propagation delay when long cables are used.
 - Open correction This corrects for errors due to the stray admittance that remains when measurement ports are in the open state.
 - Short correction This corrects for errors due to residual impedance that remains when the measurement ports are shorted.
 - Load correction This corrects for deviations from true values. A standard impedance that has a known correct value is required.

5.9.1 Calibration

Connect the oscillator output of the instrument to the signal input to perform the self error correction (calibration). Use the calibration cables and BNC adapter that are provided with the instrument.

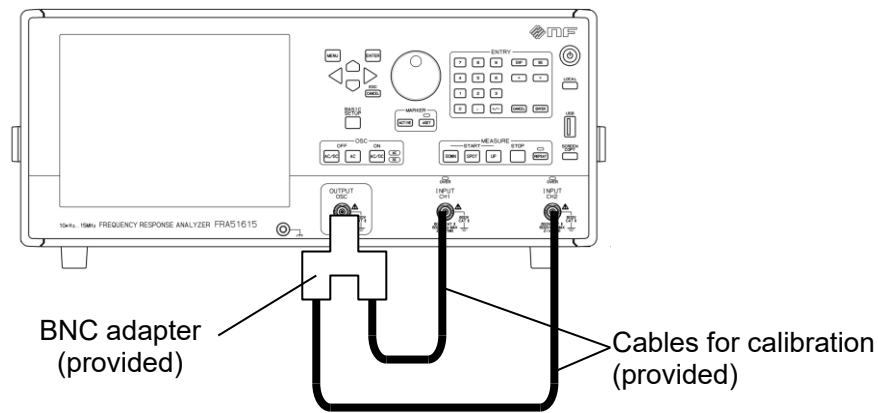
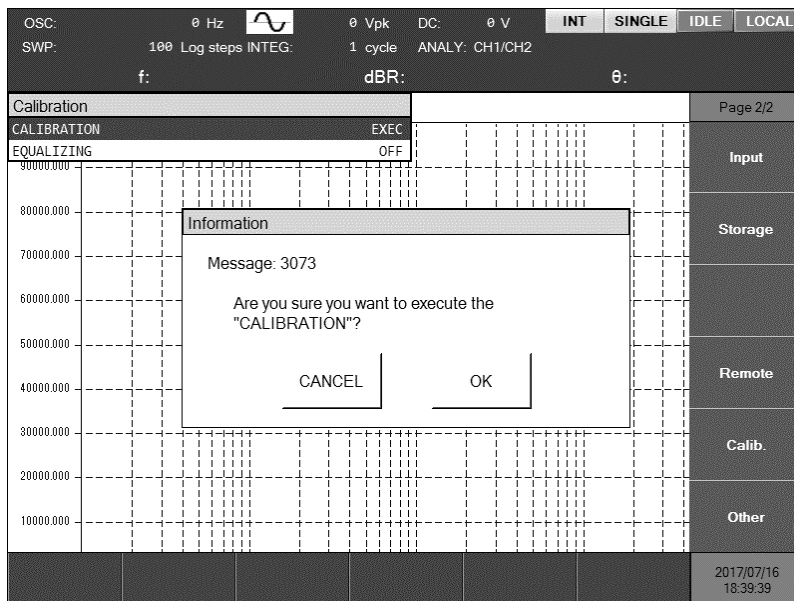
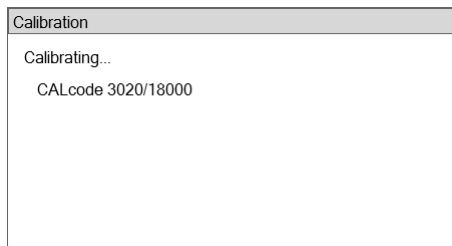

Figure 5-17 Connections for calibration

After connecting the cables, select **[Calib.] – [CALIBRATION]** and tap on the **[OK]** button or press the **[ENTER]** key on the front panel to begin the calibration.



During calibration, a window is displayed to indicate progress. If an error is detected, an error message is displayed and the operation stops. For information on errors, refer to "7.1 Error messages".



Display during calibration

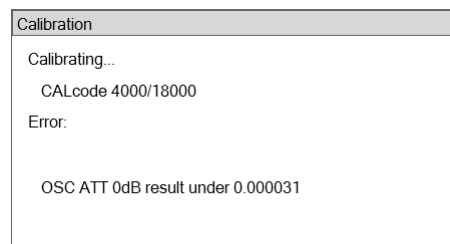

On error detection

The calibration error may indicate a problem with the instrument. Try turning the power on again and performing the calibration once more. If the error occurs again, please contact the NF Corporation or its authorized agent.

■ Cautions concerning calibration

The error factors listed below are related to the measurement itself. If any of these factors affect calibration, they will also affect subsequent measurements because the calibration would be based on measurement results that contain errors.

- Movement of the signal cables
Do not move the signal cables during calibration. Changes in the attenuation characteristic of the cable itself caused by movement can produce errors.
- Use of proper cables
Use the calibration cables that are provided with the instrument. Use of cables that are unnecessarily long or can be easily moved can produce errors that result from the attenuation characteristics of the cable itself.
- Proximity of hands or body
Do not bring your hands or body near the cables. Doing so can produce stray capacitance or perturbation noise that affects calibration.
- Sources of noise
Do not use the instrument in the proximity of large noise sources.

The factory calibration results are stored in non-volatile memory that can be read when the instrument is turned on. However, we recommend performing calibration at the times listed below.

- After the instrument power is turned on and the internal temperature has become stable (after about 30 minutes)
- After a large change in ambient temperature
- Before performing important measurements

5.9.2 Potential slope elimination

When measuring the impedance of batteries or high-capacity capacitors, etc. the DC voltage of the DUT will change over time together with the charging/discharging state of the DUT. In that case, the signal being analyzed will be superimposed on a ramp-like waveform, which, in principle, will result in errors with ordinary discrete Fourier transform (DFT) processing.

Assuming that the signal being measured is composed of a ramp wave and a sinusoidal wave, the electrical potential slope elimination function can detect the magnitude and phase of the ramp waveform (potential fluctuation waveform) and the sinusoidal waveform individually. For the analysis, only the obtained amplitude and phase of the sinusoidal waveform are used; the results for the ramp waveform component are discarded.

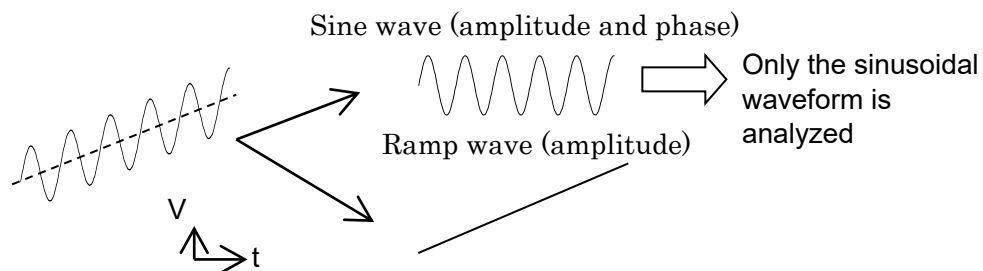

Figure 5-18 Operation of the potential slope elimination function

When the potential slope elimination function is off, errors caused by potential fluctuation that occurs over one cycle of the sine wave component such as listed in Table 5-1 can occur (theoretical worst-case).

Table 5-1 Error due to potential slope (theoretical values)

Potential fluctuation in one cycle	Amplitude error	Phase error
0%	0%	0 deg
1%	±1%	±0.5 deg
10%	±7%	±4 deg
100%	±70%	±40 deg

When the potential slope elimination function is on, errors such as listed in the above table theoretically go to zero. Actually, however, error due to noise, deviation from the ramp waveform (nonlinear potential fluctuations) and other such effects remains. Nevertheless, the effects of potential fluctuation are greatly reduced compared with when the function is turned off. Depending on the conditions, reduction on the order of several orders of magnitude may be obtained.

The potential slope elimination function can be set with **【Measure】** – [SLOPE COMPENSATION]. The setting applies to both CH1 and CH2.

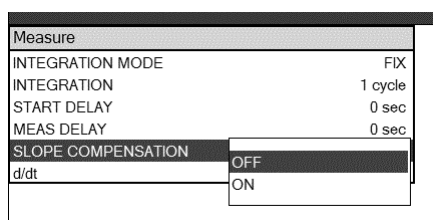

■ Cautions concerning the potential slope elimination function

- For normal use of this instrument, turn the potential gradient function off.

The potential gradient function is for analyzing signals that contain variation in electrical potential. For usual measurements, this function should be turned off. The measurement accuracy specifications for this instrument are defined for operation with this function turned off.

- Frequency range restrictions

This function is intended for low-frequency measurements such as electrochemical measurements. It is generally effective at frequencies below about 1 kHz (cycles of 1 ms or more). It is not effective for signals that involve sudden changes in electrical potential.

- Restrictions on the potential fluctuation waveform

For electrical potential fluctuation, a waveform that changes linearly over time is assumed. Fluctuation waveforms that involve exponential change functions or waveforms for which there is switching between charging and discharging during the analysis (triangular potential fluctuation waveforms) cannot normally be eliminated.

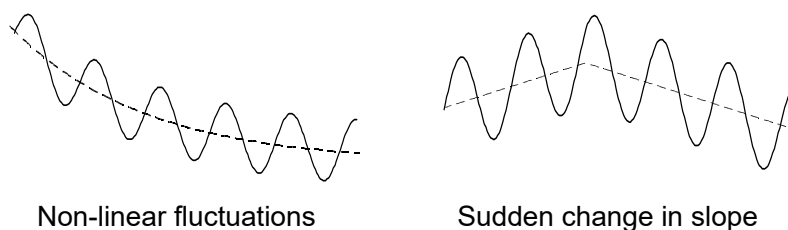

Figure 5-19 Examples of potential fluctuation waveforms that cannot be eliminated

5.9.3 Input weighting

This function performs gain correction on the results of measurements performed with a 10:1 passive probe intended for use with oscilloscopes or pre-amplifiers, etc. connected to the input connectors of the instrument (CH1 and CH2) and displays the results. The correction is converted to an input signal level for the measurements. The setting is done with **[Input]** – **[WEIGHTING FACTOR]**.

Input	
MEASURE RANGE	
CH1	AUTO
CH2	AUTO
OVER DETECT	
DETECT LEVEL	
CH1	600 Vrms
CH2	600 Vrms
ACTION	
BEEP	OFF
SWEEP	OFF
WEIGHTING FACTOR	
CH1	100.000 E-02
CH2	100.000 E-02
INVERT	OFF

[CH1], [CH2] : Set the factors to be applied to CH1 and CH2 for measurement. If a factor of 1.0 is set, there will be no change in the measurement data.

[INVERT] : Invert the phase of the measurement results (180 degrees). The amplitude and gain are not changed, but the measurements are performed with the phase increased by 180°.

Note that the input weight setting does not affect input over-level detection, amplitude compression, or automatic high density sweeping. Those functions operate in the same way as without the weighting.

■ Examples of setting weight coefficients

- When using a 10:1 oscilloscope probe

When a probe is connected to CH1, **[CH1]** is set to 10.0. The setting is similar when the probe is connected to CH2. The setting is the inverse of the probe attenuation. It is the same when an attenuator is connected.

- When using a preamplifier

When a preamplifier that has a gain of 40 dB ($\times 100$) is connected to CH1, **[CH1]** is set to 0.01 (1/100). The setting is similar when the probe is connected to CH2.

- When using a shunt resistance

For impedance measurements, a current detection resistance (shunt resistor) is used for conversion of current to voltage. The connection is to CH2. **[CH2]** is set to the inverse of the shunt resistance. If a 10 Ω shunt resistor is used, **[CH2]** is set to 0.1.

- When using a current probe

When using a 0.1 V/A current probe, the weight coefficient for the channel to which the current probe is connected is set to 10.0.

■ Constraints on the input weighting function

The values that can be set with the input weighting function are limited to real numbers (not complex numbers) that are independent of the measurement frequency. For that reason, the phase does not change when the amplitude and gain of the measurement results are corrected.

For more accurate correction that includes the frequency characteristic and phase change, use the equalizing function (for gain-phase measurements) and the open correction, short correction, and load correction functions (for impedance measurements).

■ Example of phase inversion function setting (INVERT)

This is set to [ON] when the signal polarity of either one of CH1 or CH2 is reversed in a connection. It is normally set to [OFF].

Set this function to [ON] when performing impedance measurements using the "PA-001-0368 IMPEDANCE MEASUREMENT ADAPTER" (optional). For more information, refer to the instruction manual for the " PA-001-0368 IMPEDANCE MEASUREMENT ADAPTER".

5.9.4 Equalizing

This function corrects for errors of externally connected cables and probes, etc. This function is used in gain-phase measurement.

The method of correcting for systematic error is explained with the connection example shown in Figure 5-20.

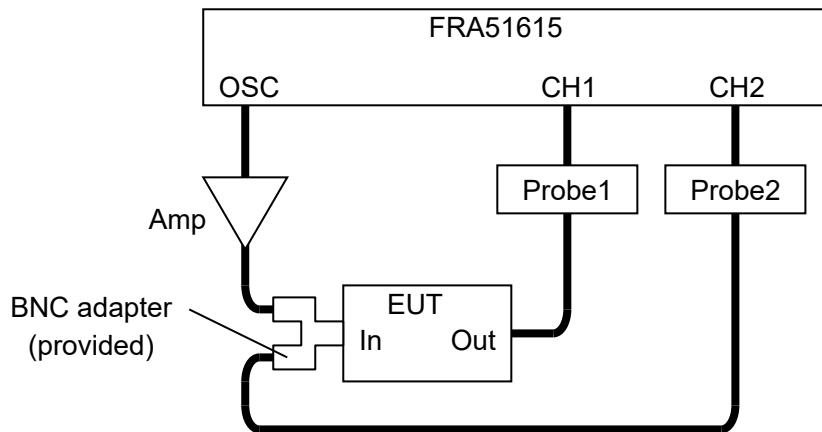

Figure 5-20 Example of connections for gain-phase measurement

The set up and measurement procedure is described below.

- 1) Set the measurement conditions, including the sweep frequency range, measurement range, and oscillator amplitude, etc.
- 2) Set **【Calibration】** – [EQUALIZING] to [OFF].
- 3) Remove the equipment under test (EUT) and connect the input and output.

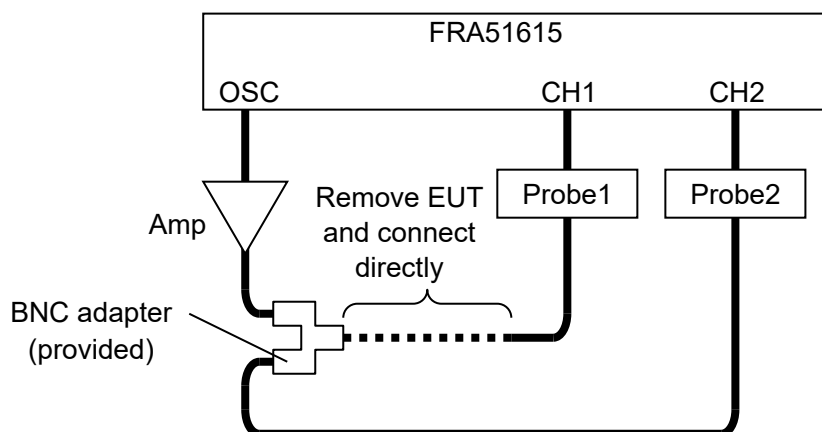

Figure 5-21 Example of connections for systematic error

- 4) Turn the oscillator output on and perform a sweep measurement under the same conditions as when measuring the EUT.

- 5) When the sweep measurement is completed, select **【Trace】** – **[MEAS COPY]** and tap the **[EQUALIZE CORR MEM]** function key to copy the measurement data to the internal equalizing memory of the instrument.



- 6) Set **【Calibration】** – **[EQUALIZING]** to **[ON]**.
- 7) Restore the original connections as they were prior to removing the EUT in step 3 ("Figure 5-20 Example of connections for gain-phase measurement").

The procedure described above completes the equalizing preparation. Performing a sweep measurement produces measurement data that is corrected for error in probes, cables and other such parts of the measurement system.

The correction data that has been copied to the equalizing memory is retained, even if the instrument power is turned off. It is therefore available and ready for use the next time the power is turned on. However, this function is executed as part of the error correction process for the instrument itself, so we recommend that the equalizing correction data be measured again when the internal temperature of the instrument has stabilized after the power is turned on (about 30 minutes) or when there has been a sudden change in the ambient temperature, etc.

■ Cautions concerning equalizing

- Even if the correction data has been measured and copied to the equalizing memory, the function will not work unless it has been enabled by setting **【Calibration】** – [EQUALIZING] to [ON].
- When equalizing is performed, the amplitude of CH2 is normalized to 1.0 (Vrms) and displayed. Corrected results are obtained for gain and phase, but please note that the amplitudes displayed for CH1 and CH2 differ from the measured amplitudes.
- If the frequency of the correction data is different from the measurement frequency, use frequency interpolation to calculate the correction data. If the correction data sweep is coarse, the interpolation error can be large. Whenever possible, measure the correction data at the same frequency as the measurement frequency (range and density).
- If the correction data is measured outside the range specified by the upper and lower frequency limits, Equalizing calculations are performed using the correction data for the nearest frequencies (the upper limit frequency or the lower limit frequency).
- If you set the function to ON without saving the correction data, an error message (-3073) is displayed. (Refer to "Table 7–3 Errors that occur during measurement".) The results of measurements made under those conditions is NaN (Not a Number).

5.9.5 Port extension

This correction function is used when making impedance measurements with two-port connections and long cables. It corrects for the phase delay that occurs from propagation delay in cables.

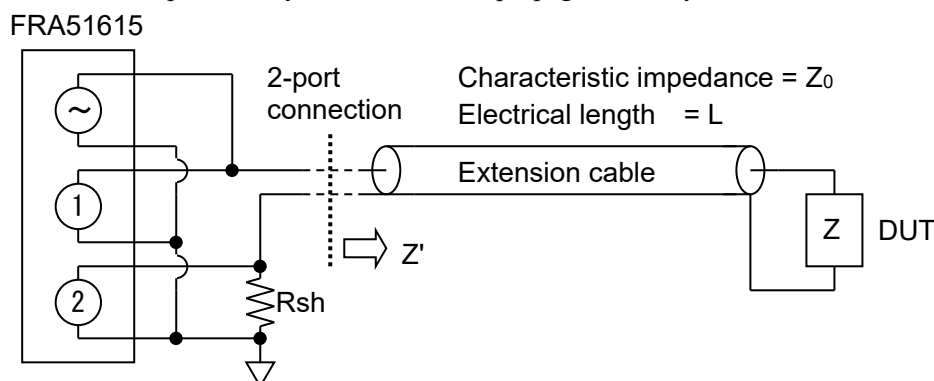

Figure 5-22 Impedance measurement connection example (2-port connection)

This function is set with **【Calibration】** – [PORT EXTENSION]. The values set are characteristic impedance [Z0] (Ω) and electrical length [ELECTRICAL LENGTH](m).

Calibration	
CALIBRATION	EXEC
EQUALIZING	OFF
OPEN CORRECTION	OFF
SHORT CORRECTION	OFF
LOAD CORRECTION	OFF
LOAD STANDARD FORMAT	Cs-D
LOAD STANDARD VALUE >	
PORT EXTENSION	OFF
Z0	50 Ω
ELECTRICAL LENGTH	0 m

■ About the port extension function

- This function is effective when the connection distance to the DUT is long (a few meters or more).
- This correction applies to two-port connections. Applying this correction to other connection configurations will increase error rather than reduce it.
- When a standard impedance is available, the error correction method described in "5.9.7 Load correction" is recommended. Port extension correction provides an easy way to correct for phase delay when a standard impedance is not available.
- The electrical length setting for extension cables ([ELECTRICAL LENGTH]) is not the physical length of the cable, but the electrical length (physical length \times wavelength shortening rate). The wavelength shortening rate of the RG-58A/u is 67%, but you should check the specifications of the cable that you are using for more information.
- Correction is not normally possible when using a cable that does not have a constant characteristic impedance.
- The port extension function normalizes the current amplitude (CH2 amplitude) to 1.0 (Arms). Corrected results for the impedance/admittance values are obtained, but please note that the displayed values for the voltage amplitude (CH1 amplitude) and the current amplitude (CH2 amplitude) differ from the measured amplitude values.

5.9.6 Open correction

5.9.7 Short correction

For impedance measurements, the open correction function corrects for errors caused by the stray admittance that remains after the measurement ports are opened and the short correction function corrects for errors caused by the residual impedance that remains after the measurement ports are shorted. The following diagrams show the relationship of the admittance and impedance of the DUT (true values, denoted as Y and Z), and the values measured by this instrument (denoted as Y_m and Z_m).

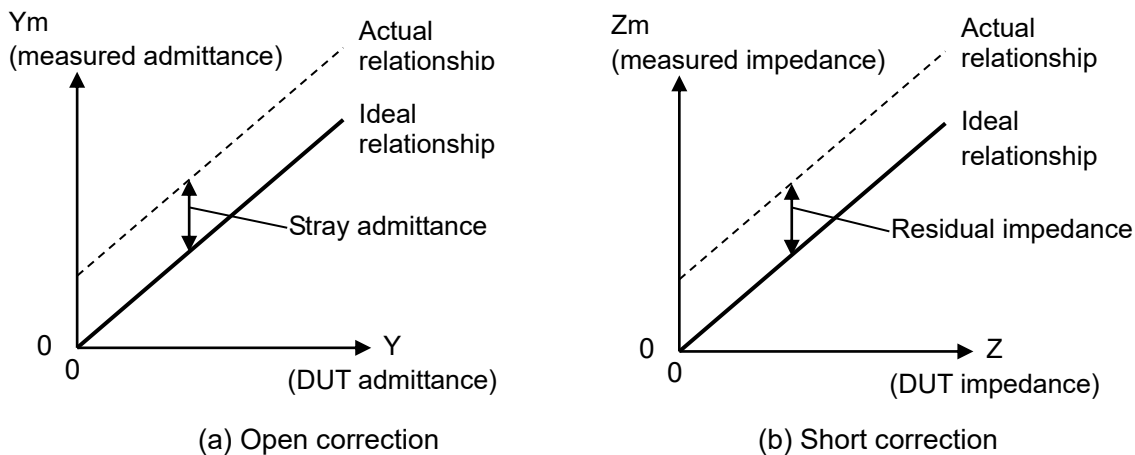

Figure 5-23 Operation of the open correction and short correction functions

Open correction subtracts a premeasured stray admittance from the measured admittance. Short correction subtracts a premeasured residual impedance from the measured impedance. These two types of correction can be performed independently and at the same time. Because they are similar operations, they are explained together here.

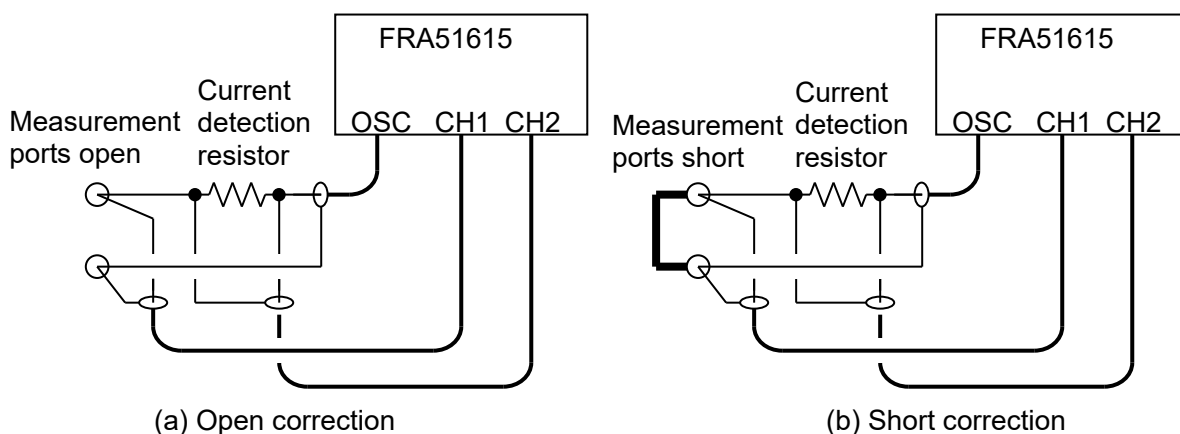
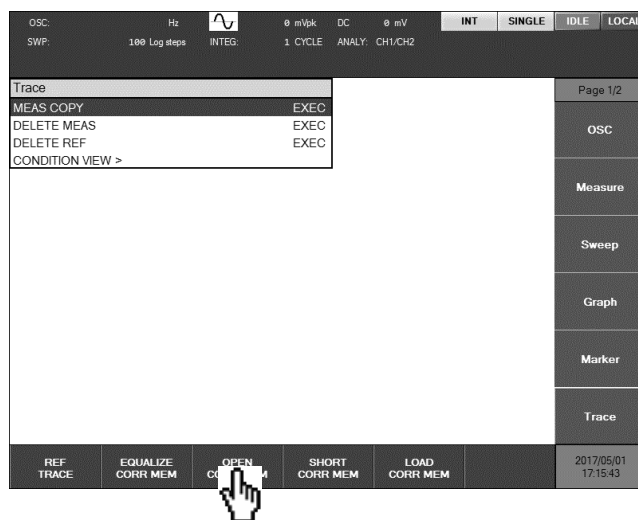

Figure 5-24 Connections for open correction and short correction

Setup and measurement are performed by the procedure described below.

- 1) Set the measurement conditions, including the sweep frequency range, the measurement range, and the oscillator amplitude, etc. Set the display unit to [IMPEDANCE] using **【Graph】** — [DISPLAY UNIT].
- 2) Set **【Calibration】** — [OPEN CORRECTION] and [SHORT CORRECTION] both to [OFF]. Measure the open correction data. If open correction is not to be done, you can skip steps 3) to 5) and continue beginning with step 6).
- 3) Open the measurement ports. (Refer to (a) in "Figure 5-24 Connections for open correction and short correction".) Keep the spacing and positions at the measurement ports the same as for when performing DUT measurement.
- 4) Turn the oscillator output on and perform a sweep measurement. Wait until the measurement is completed.
- 5) Select **【Trace】** — [MEAS COPY] and tap on the [OPEN CORR MEM] function key to copy the correction measurement data to the open correction memory.



At this point you have completed preparation of the open correction data. In the following steps, the short correction data is measured. If short correction is not to be performed, you can skip steps 6) to 8) and continue beginning with step 9).

- 6) Short the measurement ports (Refer to (b) in "Figure 5-24 Connections for open correction and short correction".) Keep the spacing and positions at the measurement ports the same as for when performing DUT measurement and short the ports with a metal plate that has low inductance.
- 7) Turn the oscillator output on and perform a sweep measurement. Wait until the measurement is completed.
- 8) Select **【Trace】** — [MEAS COPY] and tap on the [SHORT CORR MEM] function key to copy the correction measurement data to the short correction memory.

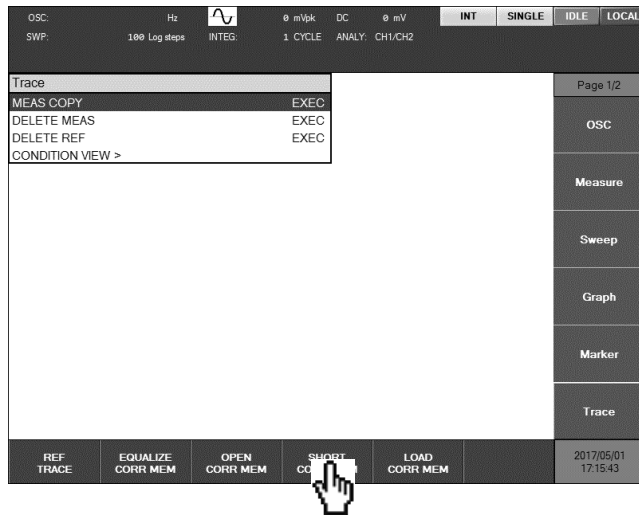

9) Enable the correction function. Use **【Measure】** —[OPEN CORRECTION] or —[SHORT CORRECTION] to set the correction function to ON.

Calibration	
CALIBRATION	EXEC
EQUALIZING	OFF
OPEN CORRECTION	OFF
SHORT CORRECTION	OFF
LOAD CORRECTION	OFF
LOAD STANDARD FORMAT	Cs-D
LOAD STANDARD VALUE >	
PORT EXTENSION	OFF
Z0	50 Ω
ELECTRICAL LENGTH	0 m

The preparation for open correction or short correction is completed by performing the steps described above. Measurement data that has been corrected for stray admittance or residual impedance in the measurement system can be obtained by connecting the DUT to the measurement ports and performing the measurements.

The correction data that has been copied to the open correction memory or the short correction memory is retained, even if the power to the instrument is turned off, so it is available for use the next time the power is turned on. However, these functions are also executed as a part of the error correction process of the instrument itself, so we recommend that the open correction data or short correction data be measured again after the internal temperature has stabilized (about 30 minutes after power up) and after any change in the ambient temperature.

■ Cautions concerning open correction and short correction

- Even if the correction data is measured and copied to the correction memory, the correction function is not executed unless it is enabled by setting **【Calibration】** —[OPEN CORRECTION] or —[SHORT CORRECTION] to [ON].
- For both open correction and short correction, the current amplitude (CH2 amplitude) is normalized to 1.0 (Arms) for display. Corrected results for the impedance or admittance values are obtained, but please note that the displayed values for the voltage amplitude (CH1 amplitude) and the current amplitude (CH2 amplitude) differ from the measured amplitude values.
- If the frequency of the correction data is different from the measurement frequency, frequency interpolation is used to calculate the correction data. If the correction data sweep is coarse, the interpolation error can be large. Whenever possible, measure the correction data at the same frequency as the measurement frequency (range and density).
- If the correction data is measured outside the range specified by the upper and lower frequency limits, use the correction data for the nearest frequencies (the upper limit frequency or the lower limit frequency) for the correction calculations.
- If you set the function to ON without saving the correction data, an error message (-3074, no open correction data; or -3074 no short correction data) is displayed. (Refer to "Table 7–3 Errors that occur during measurement".) The results of measurements made under those conditions is NaN (Not a Number).

5.9.8 Load correction

The open correction and short correction functions can correct (subtract) the stray admittance and residual impedance that exist in measurement results. Those functions can remove the residual and stray components of each frequency, but they cannot correct gain errors. For example, the gain error of the current-voltage converter (error in the resistance value of a shunt resistor) or gain error in a voltage detector, etc. cannot be improved by open correction or short correction. As illustrated in "Figure 5-25 Load correction operation", it is necessary to perform load correction to correct errors that are caused by a slope component in the signal.

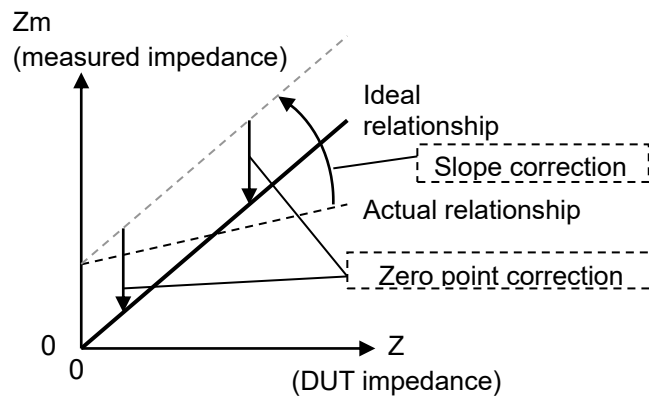

Figure 5-25 Load correction operation

Load correction uses a standard impedance that has a known value as a reference to correct measurement errors that are due to the circuit network that connects the measurement ports of the instrument to the DUT. For accurate correction, the impedance of the standard impedance device should be as close as possible to the impedance of the DUT.

Load correction is always performed together with open correction and short correction. Assuming a linear two-port paired circuit network, it is possible to eliminate error due to the connection network by performing open, short, and load correction. Load correction also has the effect of reducing small errors in frequency, signal level, and measurement range that occur under certain conditions. However, if the assumed model differs from the actual model, error may actually be increased rather than decreased.

Setup and measurement are performed by the procedure described below.

- 1) Set the measurement conditions, including the sweep frequency range, the measurement range, and the oscillator amplitude, etc. Set the display unit to [IMPEDANCE] with **【Graph】** – [DISPLAY UNIT].
- 2) Set **【Calibration】** – [OPEN CORRECTION], [SHORT CORRECTION], and [LOAD CORRECTION] all to [OFF].

Measure the open correction data. Refer to "5.9.6 Open correction".

- 3) Open the measurement port circuit. (Refer to (a) in "Figure 5-24 Connections for open correction and short correction".) Keep the spacing and positions at the measurement ports the same as for when performing DUT measurement.
- 4) Turn the oscillator output on and perform a sweep measurement. Wait until the measurement is completed.
- 5) Select **【Trace】** — [MEAS COPY] and tap on the [OPEN CORR MEM] function key to copy the correction measurement data to the open correction memory.

Measure the short correction data. Refer to "5.9.7 Short correction".

- 6) Short the measurement ports (Refer to (b) in "Figure 5-24 Connections for open correction and short correction".) Keep the spacing and positions at the measurement ports the same as for when performing DUT measurement and short the ports with a metal plate that has low inductance.
- 7) Turn the oscillator output on and perform a sweep measurement. Wait until the measurement is completed.
- 8) Select **【Trace】** — [MEAS COPY] and tap on the [SHORT CORR MEM] function key to copy the correction measurement data to the short correction memory.

Measure the load correction data and input the load standard value.

- 9) Connect the impedance standard device to the measurement ports. Keep the spacing and positions at the measurement ports the same as for when performing DUT measurement.
- 10) Turn the oscillator output on and perform a sweep measurement. Wait until the measurement is completed.
- 11) Select **【Trace】** — [MEAS COPY] and tap on the [LOAD CORR MEM] function key to copy the correction measurement data to the load correction memory.

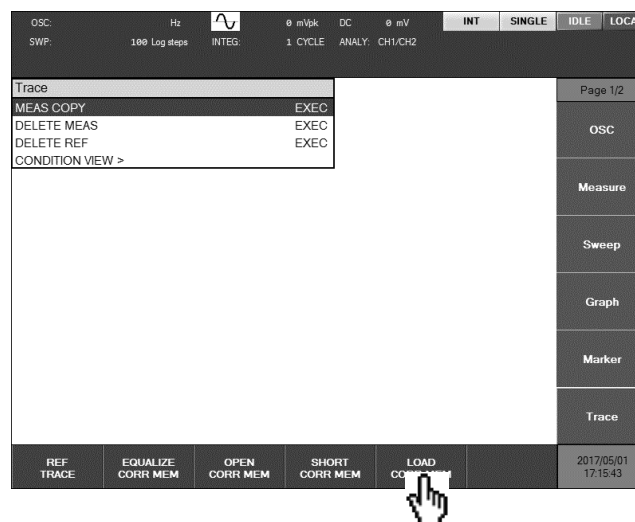

- 12) Set the load standard value format. Use **【Calibration】** —[LOAD CORRECTION]—[LOAD STANDARD FORMAT] to select the standard value format from among [Cs-D], [Cp-D], [Rp-Cp], [Rs-Ls], [Rs-X], and [Z-θ].

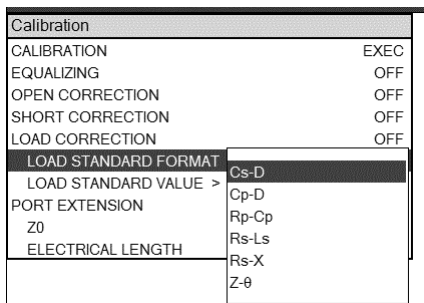

- 13) Enter the load standard value. Select **【Calibration】** —[Load Standard Value] and press the **ENTER** key. In the table that is displayed, enter the load standard values. The entered load standard values must be within the measurement frequency range and be entered for at least three frequencies. Values can be entered for up to 10 frequencies.

Calibration				
CA > Load Standard Value				
EC	No.	FREQUENCY	Cs	D
OF	1	100 Hz	101.050 E-08F	156.000 E-05
SH	2	200 Hz		
LO	3			
	4			
	5			
PC	6			
	7			
	8			
	9			
	10			

After entering the load standard values, press the **CANCEL** key to close the value input table.

- 14) Set **【Calibration】** —[LOAD CORRECTION] to [ON]. Load correction can be done normally with —[OPEN CORRECTION] and [SHORT CORRECTION] set to [OFF] .

The preparation for load correction is completed by performing the steps described above. If you disconnect the standard impedance device and perform the measurement with the DUT connected to the measurement ports, load-corrected measurement data can be obtained.

The correction data that has been copied to the open, short, and load correction memory is retained even if the power to the instrument is turned off, so it is available for use the next time the power is turned on. However, these functions are also executed a part of the error correction process of the instrument itself, so we recommend that the open, short, and load correction data be measured again after the internal temperature has stabilized (about 30 minutes after power up) and after any change in the ambient temperature.

■ Cautions concerning load correction

- Even if the correction data is measured and copied to the respective correction memory, the correction function is not executed unless it is enabled by setting **【Calibration】** —[LOAD CORRECTION] to [ON].
- The impedance standard device that is used should have an impedance value that is as close as possible to the impedance of the DUT. A large difference between the two may produce error in the measurement of the load correction data or a large error in internal calculations, resulting in insufficient correction. Use an impedance standard device that differs in impedance with the DUT by no more than about a factor of 10 (or a factor of 0.1).
- For the load standard value, you can use either the calibration value of the impedance standard device or an actual measured value obtained with an impedance measuring instrument (LCR meter, etc.).
- Load correction uses the load standard value as the reference, so the accuracy of the load-corrected measurement data is limited by the accuracy of the load standard value (measurement accuracy cannot exceed the accuracy of the load standard value).
- The load standard value is saved internally in the format of "frequency- Z- θ ", regardless of the load standard value format setting. When the load standard value is entered or displayed, it is converted according to the load standard value format. For that reason, a value different from the entered value may be displayed if the load standard value format is changed after the load standard value is input. Nevertheless, there is no difference in the operation of the load correction function.
- It is necessary to enter load standard values for a least three frequencies. If a value is entered for a frequency outside the frequency range, incorrect correction results will be obtained.
- The values should be entered so that the frequencies of the load standard values are as close to equal intervals on the logarithmic axis scale as possible. Frequency interpolation is done internally, so if load standard values are entered for frequencies that are extremely close or extremely far apart (on the log axis scale), interpolation errors will increase.
- When load correction is performed, the current amplitude (CH2 amplitude) is normalized to 1.0 (Arms) for display. Corrected results for the impedance or admittance values are obtained, but please note that the displayed values for the voltage amplitude (CH1 amplitude) and the current amplitude (CH2 amplitude) differ from the measured amplitude values.
- If the frequency of the correction data is different from the measurement frequency, frequency interpolation is used to calculate the correction data. If the correction data sweep is coarse, the interpolation error can be large. Whenever possible, measure the correction data at the same frequency as the measurement frequency (range and density).
- If the correction data is measured outside the range specified by the upper and lower frequency limits, use the correction data for the nearest frequencies (the upper limit frequency or the lower limit frequency) for the correction calculations.
- If you set the function to ON without saving the correction data, an error message (-3076) is displayed. (Refer to "Table 7–3 Errors that occur during measurement".) The results of measurements made

under those conditions is NaN (Not a Number).

- The load standard values and the load correction data are stored in different memories within the instrument. The load standard values are stored in the measurement conditions memory and the load correction data are stored in a dedicated memory. For that reason, if the measurement conditions are restored, the load correction data remains as it is, but the load standard values are overridden by the restored measurement conditions. If the load standard values that are in the restored measurement conditions do not correspond to the load correction data, the load correction results will be incorrect. Therefore, take appropriate care when restoring the measurement conditions.

5.10 Differentiation and integration function

This function performs differentiation, second-order differentiation, integration, and double integration of the measurement data in the time domain. This is used when doing displacement–speed–acceleration conversion in the measurement of transfer characteristics (gain-phase measurement).

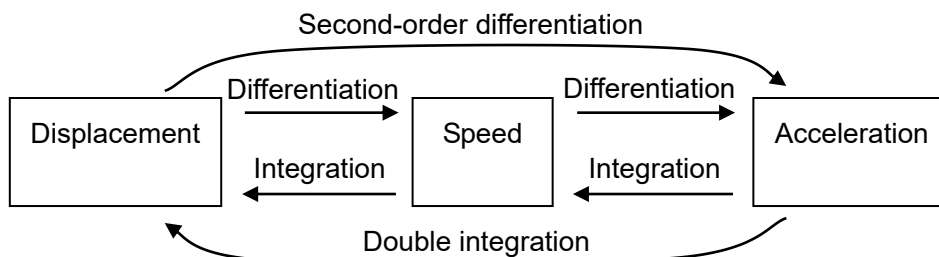

Figure 5-26 Conversion among displacement, speed, and acceleration by differentiation and integration

Differentiation in the time domain corresponds to multiplying the measurement data in the frequency domain by $j\omega$ and the second derivative corresponds to multiplication by $(j\omega)^2$. Similarly, integration corresponds to dividing the frequency domain measurement data by $j\omega$ and the double integral corresponds to division by $(j\omega)^2$. The phase is changed by $+90^\circ$ by differentiation and by -90° by integration. The setting is done by selecting **Measure** – [d/dt], pressing the **ENTER** key, and then selecting the calculation item. This function is set to **[OFF]** if integration and differentiation are not to be done.

Measure	
INTEGRATION MODE	FIX
INTEGRATION	1 cycle
START DELAY	0 sec
MEAS DELAY	0 sec
d/dt	OFF
	(j ω)
	(j ω) ²
	(1/j ω)
	(1/j ω) ²

■ Cautions concerning differentiation and integration

If differentiation and integration is enabled, the amplitude of CH2 is normalized to 1.0 (Vrms) for display. The gain (CH1/CH2) and phase values can be used to produce corrected results, but please note that the CH1 amplitude and the CH2 amplitude that are displayed differ from the measured amplitudes.

5.11 Sequence measurement

Sequence measurement is a function for reading setting memories in numerical order and performing sweep measurements. For one sweep, the frequency range can be divided into up to 20 parts and measurement can be performed with different amplitudes, integration settings, etc. for each frequency range.

If the sweep lower frequency limit (**[Sweep]** – [SWEEP LOWER]) in setting memory number m is set to f_{Lm} , and the upper frequency limit (**[Sweep]** – [SWEEP UPPER]) is set to f_{Um} , the frequency sweep measurement for one upswing is performed in the following order.

$$(f_{L1} \rightarrow f_{U1}), (f_{L2} \rightarrow f_{U2}), \dots, (f_{L(N-1)} \rightarrow f_{U(N-1)}), (f_{LN} \rightarrow f_{UN})$$

For a downswing, the order of the frequency sweep measurement is as follows.

$$(f_{UN} \rightarrow f_{LN}), (f_{U(N-1)} \rightarrow f_{L(N-1)}), \dots, (f_{U2} \rightarrow f_{L2}), (f_{U1} \rightarrow f_{L1})$$

In the above order notation, N is the highest setting memory number for which the sequence measurement is performed. That number is set with **[Sweep]** – [SEQ SWEEP]. If set to [OFF], sequence measurement is not performed.

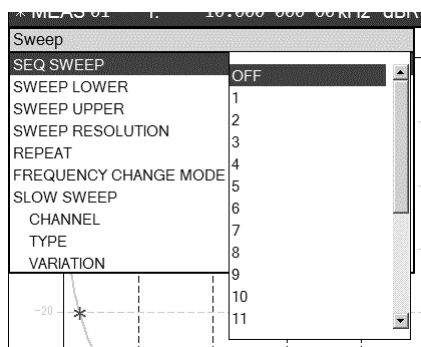

Within each sweep range, important parameters such as the oscillator amplitude are read from memory together with the sweep frequency range and the values are set. However, graph settings and other such settings are not read from the setting memory and the current settings are retained. In "Table 3–1 initial settings", the "Y" for "Sequence measurement" indicates parameters that are read from the setting memory during sequence measurement. The current setting for parameter N is used and does not change.

The data obtained by sequence measurement is handled in the same way as normal sweep measurement results (obtained with sequence measurement set to OFF).

- Graph display : All sweep data is displayed
- Marker operations : Handled as continuous sweep data
- Saving to or loading from data memory : Handled as a single data file

■ Cautions concerning sequence measurement

- The validity check is not performed for the sweep frequency range of each setting memory number. Depending on the settings in the memory, the sweep frequencies may be greatly separated or the sweep ranges may overlap when the memory number is changed. Nevertheless, the measurements in sequence measurement are performed in the order of the setting memory number.
- For marker operations on sequence measurement data, the markers are moved in the order in which the sequence measurements were performed. If the high and low values of the sweep range are reversed between setting memories, turning the control knob to the right (clockwise) may move the marker in the direction of lower frequencies.
- The total number of sweep frequency points that can be measured in a single sequence is the sum of the number for memory 1 through memory N (largest memory number) and the maximum total is 20,001 frequency points. If the maximum number is reached while sequence measurement is still in progress, the measurement is stopped at that time. No check is made for the limit on the number of sweep points before the measurement begins. If the automatic high density sweep function (SLOW sweep) is used, please note that there may be an unexpected increase in the number of frequency points.

5.12 Memory operations

Measurement conditions and measurement data can be saved to internal memory or to a USB memory device and can be read from memory and reused. It is also possible to save an image of the LCD screen to USB memory as a file in bitmap format (.bmp).

5.12.1 Saving and restoring measurement conditions

The current measurement conditions can be saved to internal memory or to a USB memory device and then later read from memory and restored. Up to 20 sets of settings can be saved to internal memory. The measurement conditions saved in internal memory can also be used for sequence measurement. For more information on sequence settings, "5.11 Sequence measurement".

Select **[Storage]** – **[CONDITION FILE >]** and press the **[ENTER]** key to display a list of the measurement condition files that are stored in internal memory. The memory that has the name "Condition_Default" contains the factory default setting (initial setting).

■ Saving measurement conditions (internal memory)

1) Select save destination memory

2) Tap [SAVE]

3) Enter file name

4) Tap ENTER

5) Tap OK

DA No.	Name	Date
EJ 1	TEST	2017/05/02 18:25:47
HC2	R100=10ohm	2017/05/02 18:26:38
3	Condition_Default	yyyy/mm/dd hh.MM.ss
4	Condition_Default	yyyy/mm/dd hh.MM.ss
5	Condition_Default	yyyy/mm/dd hh.MM.ss
6	Condition_Default	yyyy/mm/dd hh.MM.ss
7	Condition_Default	yyyy/mm/dd hh.MM.ss
8	Condition_Default	yyyy/mm/dd hh.MM.ss
9	Condition_Default	yyyy/mm/dd hh.MM.ss
10	Condition_Default	yyyy/mm/dd hh.MM.ss
11	Condition_Default	yyyy/mm/dd hh.MM.ss

7	8	9	/	'	()	BS	SPACE
4	5	6	*	\$	%	&	<-	->
1	2	3	-	!	"	#		
0	.	=	+	_	SHIFT		CANCEL	ENTER

Use the knob or the cursor keys to select the destination memory for saving the conditions and then tap on the **[SAVE]** function key. In the **[TEXT]** dialog, enter the file name and then tap on the **[OK]** button. A save confirmation dialog will be displayed. Tap on the **[OK]** to save the measurement conditions.

■ Restoring measurement conditions (internal memory)

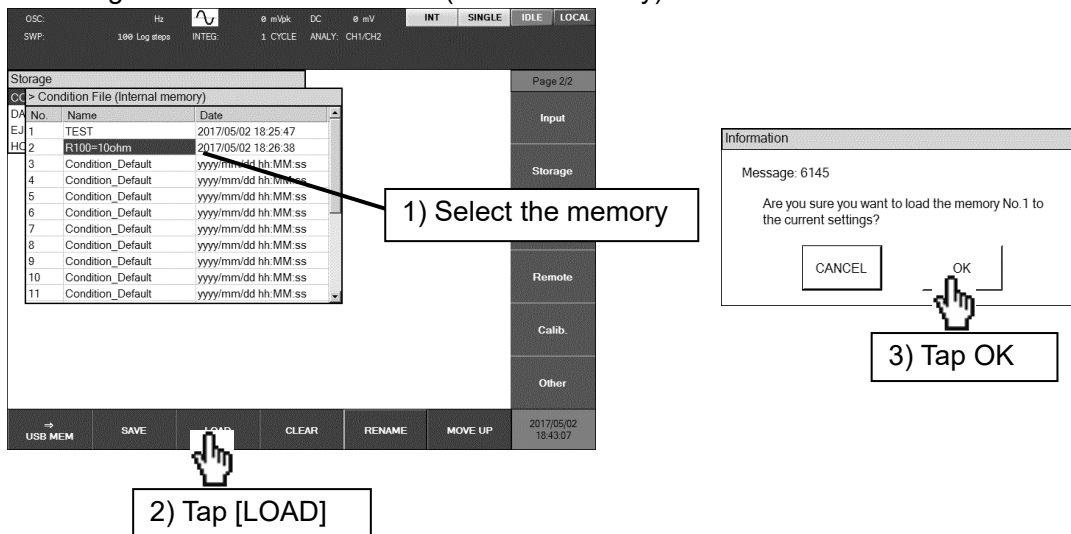

Use the control knob or the cursor keys to select the memory from which to restore the measurement conditions and then tap the [LOAD] function key. The load confirmation dialog will be displayed. Tap on the **OK** button to restore the selected measurement conditions.

■ Other operations (internal memory)

- [CLEAR] function key

This initializes (clears) the selected memory. The memory name becomes "Condition_Default".

- [RENAME] function key

This changes the name of the selected memory.

- [MOVE UP] function key

This moves the selected memory one position upward in the list. This function is used to change the measurement order for sequence measurement.

■ Saving measurement conditions (USB memory device)

Insert a USB memory device into the USB port on the front panel.

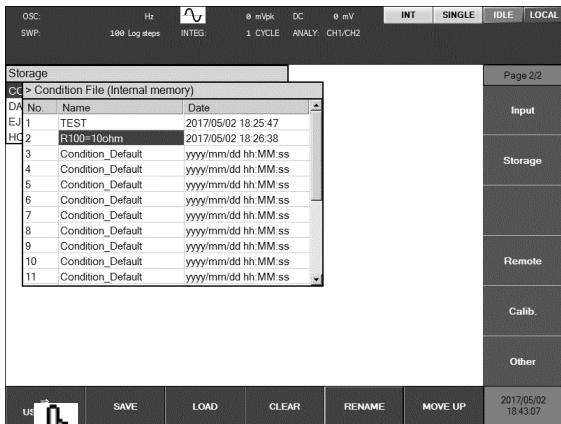

1) Tap [⇒USB MEM]

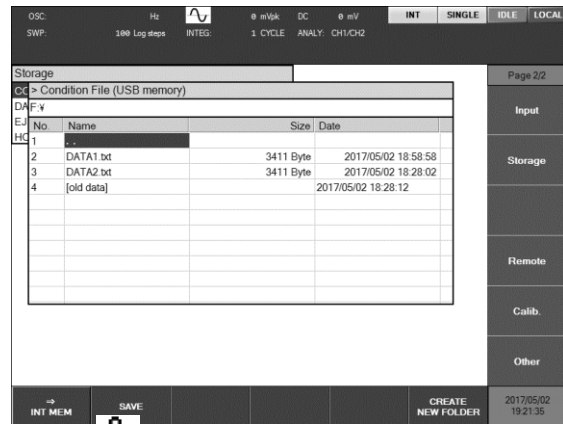

2) Tap [SAVE]

3) Enter the file name

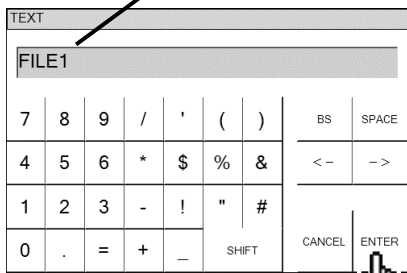

4) Tap ENTER

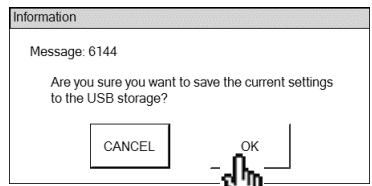

5) Tap OK

Tap on the [⇒USB MEM] function key to display a list of the files in the USB memory device. Tap on the [SAVE] function key and enter the file name in the **TEXT** dialog. Tap on the **ENTER** button. When the save confirmation dialog is displayed, tap on the **OK** button to save the measurement conditions.

■ Restoring measurement conditions (USB memory device)

Insert a USB memory device into the USB port on the front panel.

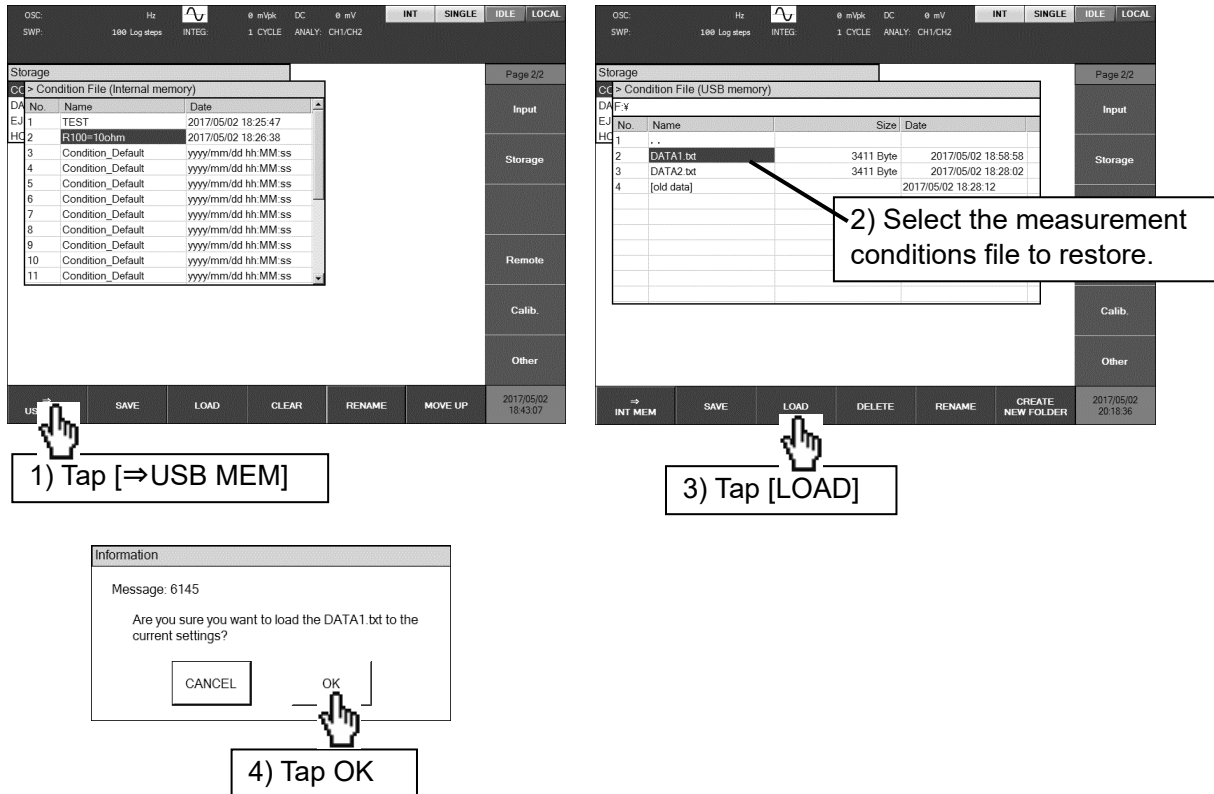

Use the control knob or the cursor keys to select the file from which to restore the measurement conditions and then tap the [LOAD] function key. The load confirmation dialog will be displayed. Tap on the **OK** button to restore the selected measurement conditions.

■ Other operations (USB memory)

- [DELETE] function key

This deletes the selected file.

- [RENAME] function key

This changes the name of the selected file.

- [CREATE NEW FOLDER] function key

This creates a new folder.

- Change the current folder

Subfolders are indicated by filenames enclosed in brackets ([]). The file name ".." indicates a folder one level higher in the folder hierarchy. The current folder is changed by selecting a file name and pressing the **ENTER** key.

The measurement condition files that are stored in the USB memory device are text format files. For information on the format, refer to "6.3 Measurement condition file format".

5.12.2 Measurement data

Measurement data can be saved to the internal memory of the instrument or to a USB memory device and then loaded at a later time for use. The data that can be stored is MEAS TRACE and REF TRACE data.

The saved measurement data can be loaded for display in graph form or for use as error correction data by the equalizing function, etc.

The internal memory can hold up to 20 sets of measurement data.

Select **【Storage】** – [DATA FILE >] and press the **ENTER** key to display a list of measurement data sets that are stored in internal memory. If the data name is "<empty>", there is no data at that location.

■ Saving measurement data (internal memory)

1) Select the destination memory

2) Tap [SAVE]

3) Select the data to save

4) Enter the file name

5) Tap ENTER

6) Tap OK

Use the knob or the cursor keys to select the destination memory for saving the data and then tap on the **[SAVE]** function key. Select the trace that is to be saved by tapping the **[MEAS TRACE]** or **[REF TRACE]** function key. Use the **【TEXT】** dialog to enter the file name and then tap on the **[ENTER]** button to display the save confirmation dialog. Tap on the **OK** button to save the measurement data.

■ Loading measurement data (internal memory)

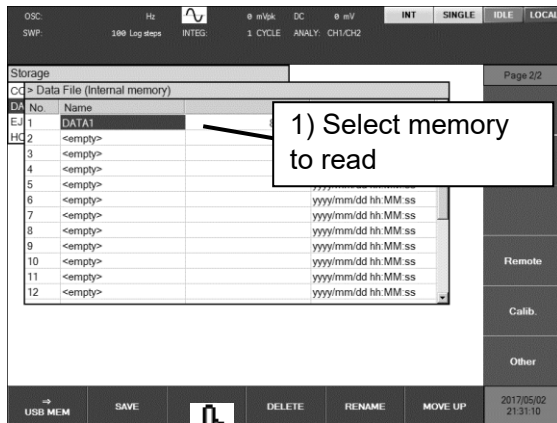

2) Tap [LOAD]

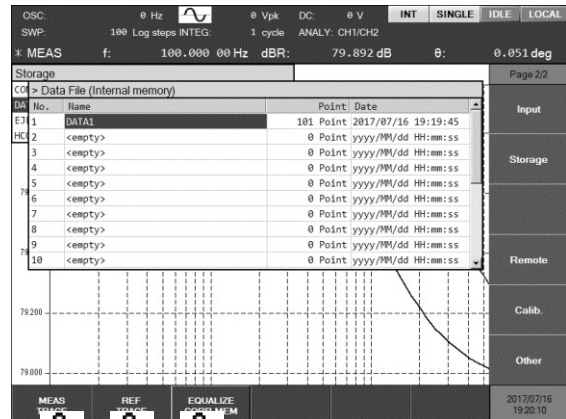

3) Select the destination

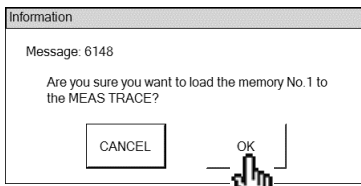

4) Tap OK

Use the control knob or the cursor keys to select the memory from which to read the measurement data and then tap the [LOAD] function key. Tap on a function key to select the destination for loading the data.

- [MEAS TRACE] : Load to the measurement data trace.
- [REF TRACE] : Load to the reference data trace.
- [EQUALIZE CORR MEM] : Load to the equalizing correction data.
- [OPEN CORR MEM] : Load to the open correction data.
- [SHORT CORR MEM] : Load to the short correction data.
- [LOAD CORR MEM] : Load to the load correction data.

The load confirmation dialog will be displayed. Tap on the **OK** button to load the selected measurement data to the specified destination.

■ Other operations (internal memory)

- [DELETE] function key

This deletes the selected memory. The memory name becomes "<empty>".

- [RENAME] function key

This changes the name of the selected memory.

- [MOVE UP] function key

This moves the selected memory one position upward in the list (smaller memory number).

■ Saving measurement data (USB memory device)

Insert a USB memory device into the USB port on the front panel.

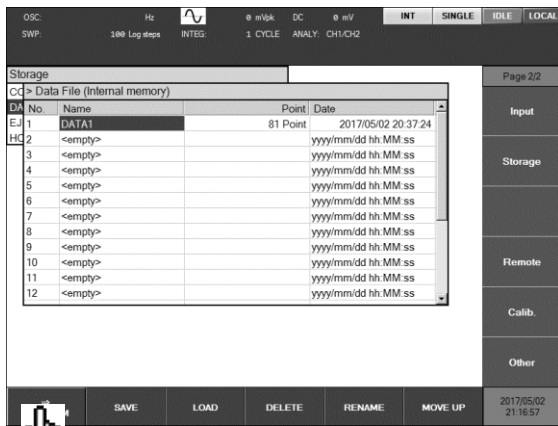

1) Tap [=>USB MEM]

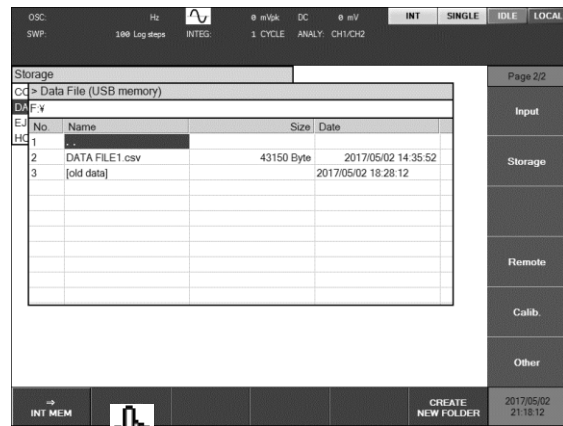

2) Tap [SAVE]

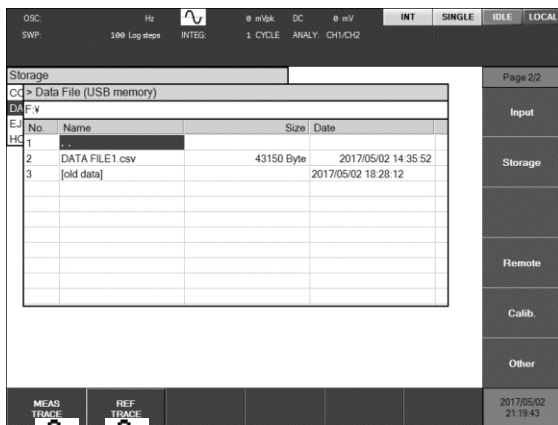

3) Select the data to save

4) Enter the file name

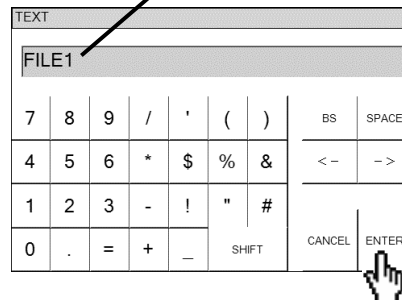

5) Tap ENTER

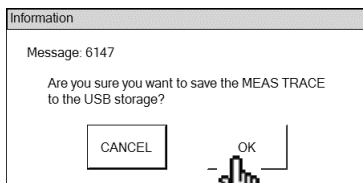

6) Tap OK

Tap on the [=>USB MEM] function key to display a list of the files in the USB memory device. Tap on the [SAVE] function key and select the trace that is to be saved by tapping the [MEAS TRACE] or [REF TRACE] function key. Use the **TEXT** dialog to enter the file name and then tap on the [ENTER] button to display the save confirmation dialog. Tap on the **OK** button to save the measurement data.

■ Loading measurement data (USB memory device)

Insert a USB memory device into the USB port on the front panel.

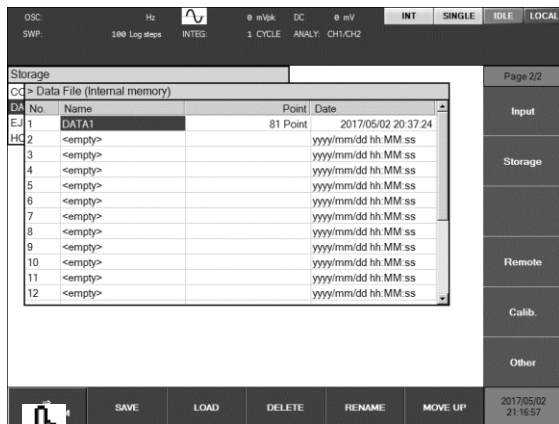

1) Tap [=>USB MEM]

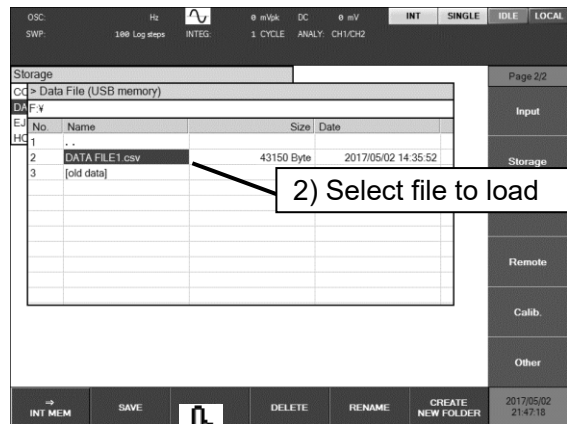

3) Tap [LOAD]

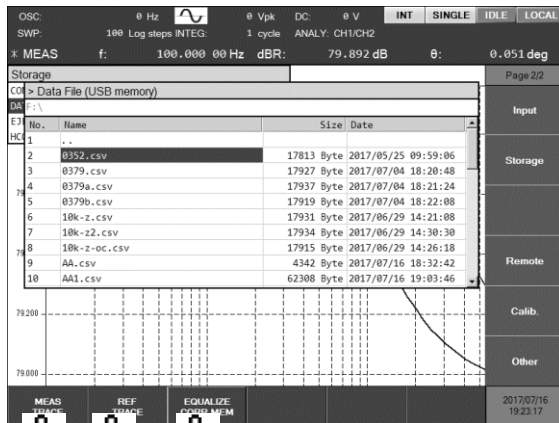

4) Select the load destination

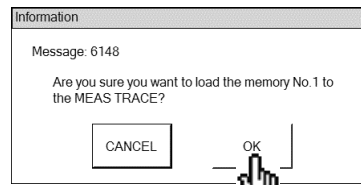

5) Tap OK

Tap on the [=>USB MEM] function key to display a list of the files in the USB memory device. Use the control knob or the cursor keys to select the file from which to load the measurement data and then tap the [LOAD] function key. Tap on a function key to select the destination for loading the data.

- [MEAS TRACE] : Load to the measurement data trace.
- [REF TRACE] : Load to the reference data trace.
- [EQUALIZE CORR MEM] : Load to the equalizing correction data.
- [OPEN CORR MEM] : Load to the open correction data.
- [SHORT CORR MEM] : Load to the short correction data.
- [LOAD CORR MEM] : Load to the load correction data.

The load confirmation dialog will be displayed. Tap on the **OK** button to load the selected measurement data to the specified destination.

■ Other operations (USB memory)

- [DELETE] function key

This deletes the selected file.

- [RENAME] function key

This changes the name of the selected file.

- [CREATE NEW FOLDER] function key

This creates a new folder.

- Change the current folder

Subfolders are indicated by filenames enclosed in brackets ([]). The file name ".." indicates a folder one level higher in the folder hierarchy. The current folder is changed by selecting a file name and pressing the **ENTER** key.

The measurement data files that are stored in the USB memory device are text format files. For information on the format, refer to "6.2 Measurement data file format".

5.12.3 LCD screen capture

This function can capture an image of the LCD screen and save it to USB memory. Insert a USB memory device into the USB port of the front panel and press the **SCREEN COPY** key to create a bitmap file in the USB memory device.



The file that is created is given the name "FRAnnn.bmp", where nnn is a serial number from 000 to 999 that is incremented each time a screen image is captured. If a file is saved with a name that already exists in the USB memory device, the existing file will be overwritten. The serial number can be set to an arbitrary three-digit number by using **【Storage】** –[HCOPY FILE NUMBER].

The file format is Microsoft Windows Bitmap Image, 800 × 600 pixels, and 16 million colors. The file size is about 1.9 MB.

5.13 External reference clock

This instrument uses an internal crystal oscillator as the reference clock, but an external 10 MHz clock signal can also be used.

Generally, an external reference clock is used for the following purposes.

- To increase accuracy by using a reference clock that is more accurate than the internal clock (a rubidium frequency standard for example)
- To establish a common frequency accuracy by using a reference clock that is shared by multiple devices

■ Inputting an external 10 MHz reference clock signal

Connect an external 10 MHz reference clock signal to the 10 MHz REF IN connector on the rear panel of the instrument. For the specification of signals that can be input and points of caution, refer to "■ 10 MHz REF IN" in "3.2 Input and output connectors".

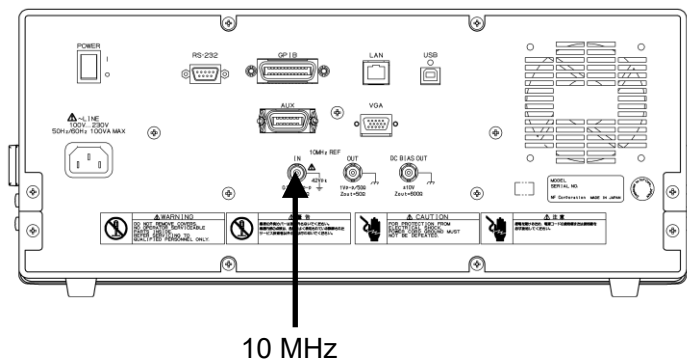

To enable the external reference clock, set **【OSC】** –[10 MHz REF]–[IN] to [ENABLE]. When the instrument is operating on an external reference clock, the status display in at the top of the screen is [EXT].

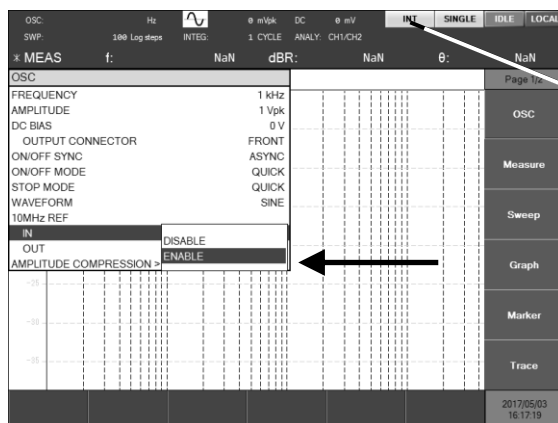

EXT Operating on an external clock
INT Operating on the internal clock

Even if a valid 10 MHz reference clock signal is being input to the 10 MHz REF IN connector, the instrument will still operate on the internal reference clock if **【OSC】 – [10 MHz REF] – [IN]** is set to **[DISABLE]**.

If an external reference clock signal is interrupted, operation automatically switches to the internal reference clock. If the external reference clock is subsequently restored, operation continues again with the external reference clock. Whether the instrument is operating on the internal clock or an external clock is indicated by the status display at the top of the screen.

■ Outputting a 10 MHz reference clock signal

It is possible to output the 10 MHz reference clock signal on which the instrument is operating. For the specifications and points of caution, refer to "■ 10 MHz REF OUT" in "3.2 Input and output connectors".

If **【OSC】 – [10MHz REF] – [OUT]** is set to **[ENABLE]**, the 10 MHz reference clock signal will be output from the 10MHz REF OUT connector on the rear panel of the instrument. If the value is set to **[DISABLE]**, the signal is not output.

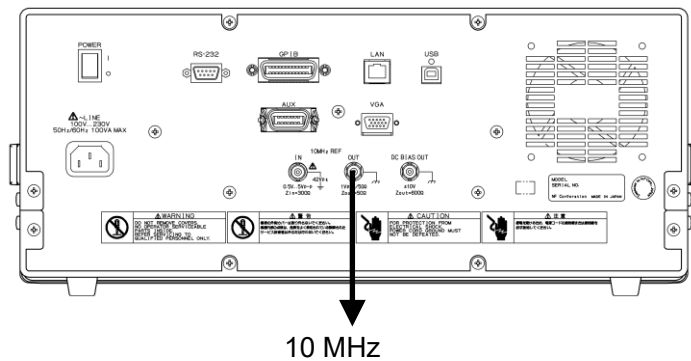
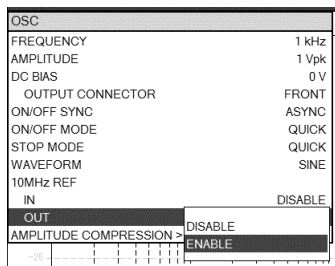

5.14 Other operations

5.14.1 Beep settings

If **【Other】** – **[BEEP]** is set to **[ON]**, a click sound is output for button operations and a pop-up sound is output when a message is displayed.

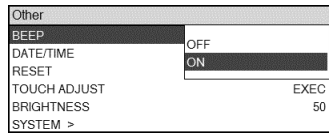

5.14.2 Internal clock settings

■ Setting the date and time

The date and time of the internal clock can be set with **【Other】** – **[DATE/TIME]**. The format for the date is yyyy/mm/dd and time is represented in 24-hour format as hh:mm:ss.

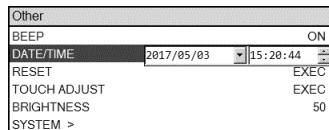

■ Setting the time zone

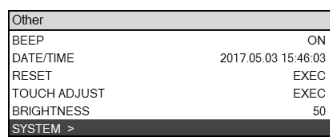

2) Select a time zone.

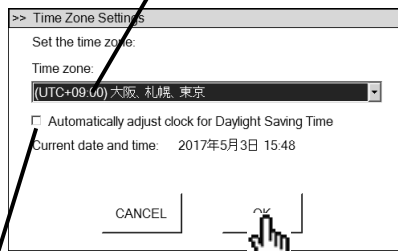

4) Tap [OK]

3) Check this to enable automatic setting for daylight saving time.

1) Tap [TIME ZONE]

Select **【Other】** – **[SYSTEM]** and press on the **[ENTER]** key. Tap on the **[TIME ZONE]** function key and select a time zone. Then check the checkbox for automatic adjustment for daylight saving time as necessary and tap **[OK]**.

5.14.3 Touch panel adjustment

Touch panel adjustment is done when there is a difference between the location on the screen that is touched and the position that is recognized by the instrument. It is not normally necessary to perform the adjustment. The adjustment procedure is described below.

- 1) Select **Other** – [TOUCH ADJUST] and press the **ENTER** key. The adjustment confirmation message will be displayed. Tap on the **OK** button to begin adjustment.

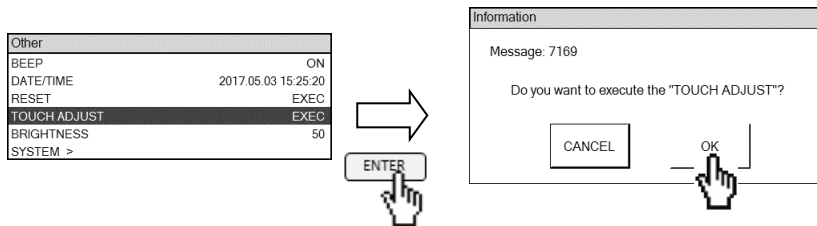

- 2) When the following message is displayed, tap two times consecutively anywhere on the screen.
Tap this monitor twice to start setting.
Press the Enter or ESC button to end.

To cancel the adjustment process, tap on **ENTER** or **CANCEL** /ESC key. The adjustment screen will close and the display will return to the **Other** dialog.

- 3) A red mark such as illustrated below will be displayed. Use your finger to tap at the center of the mark.



When you tap on the mark, the mark will then be displayed at another location. Tap at the center of the new mark. The mark will be displayed a total of four times in the upper, lower, left, and right parts of the screen.

You can cancel the adjustment process by tapping **CANCEL** /ESC key. If you cancel in that way, the adjustment results up to that time will be cleared and the instrument will be returned to the state before adjustment was begun.

- 4) After you tap at the four locations, the message shown below will be displayed. Tap on the **OK** button to complete the touch panel adjustment

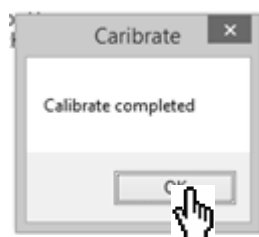

5.14.4 Adjusting the LCD backlight brightness

The backlight brightness adjustment can be done with **Other** – **[BRIGHTNESS]**. The brightness value can be set in the range from 0 to 100, with larger values indicating greater brightness. If the value is set to 0, however, the backlight is not completely turned off.

Other	
BEEP	ON
DATE/TIME	2017.05.03 15:35:28
RESET	EXEC
TOUCH ADJUST	EXEC
BRIGHTNESS	50
SYSTEM >	

5.14.5 System information display

This function displays the instrument model name, firmware version, serial number, last calibration date, and copyright information.

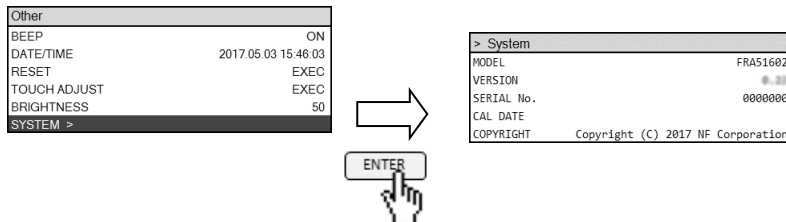

Select **Other** – **[SYSTEM]** and press the **ENTER** key to display **System**. There are no items to set.

5.14.6 Restoring factory settings

This function restores all of the instrument setting to the values that were set when the instrument left the factory.

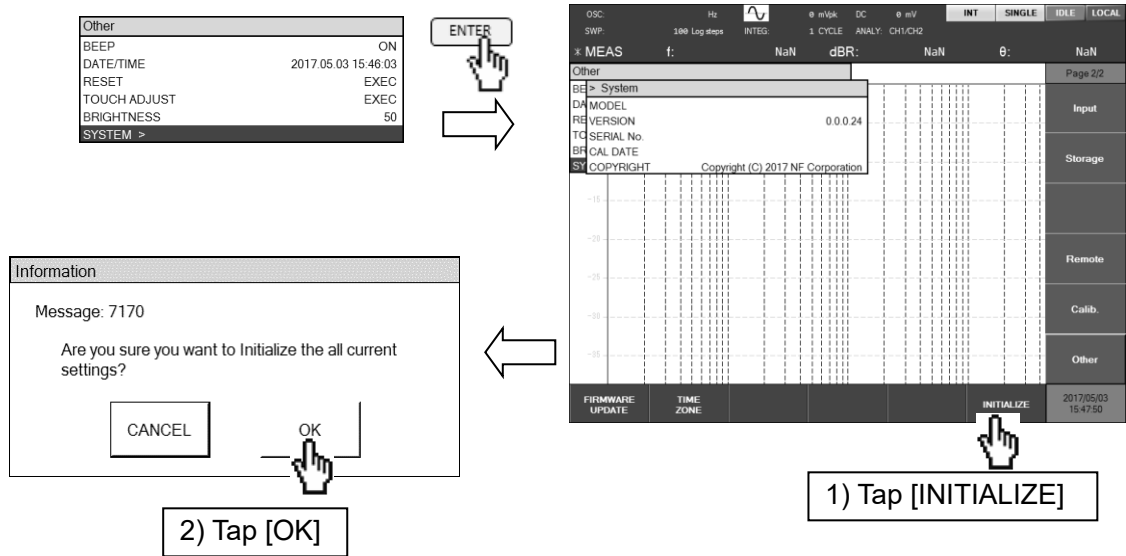

Performing the operation described above returns all settings, including the remote interface settings, the measurement data saved in internal memory, and the measurement condition files saved in internal memory (which are used in sequence measurement), to the values that were set when the product was shipped from the factory. Concerning the factory settings, refer to "Table 3-1 Initial settings".

5.14.7 Printer

A hard copy of the LCD screen of the instrument can be printed easily by using the thermal printer described below. (That product is not carried by the NF Corporation.)

Manufacturer : Seiko Instruments Inc.
Product : Thermal printer
Model : DPU-S445-00B-E

Connect the printer to the instrument with a USB cable by inserting the USB cable into the USB port on the front panel of the instrument. Press the **SCREEN COPY** key to print a hard copy.



For instructions on using the printer, refer to the instruction manual that comes with the printer.

Pressing the **SCREEN COPY** key when a USB memory device has been inserted into the USB port will create a screen capture file in bitmap format in the USB memory. For information on saving the screen capture to the USB memory device, refer to "5.12.3 LCD screen capture".

6. File formats

6.1 Overview	6-2
6.2 Measurement data file format	6-2
6.3 Measurement conditions file format	6-6
6.4 Screen capture file format	6-10

6.1 Overview

This instrument can save measurement data, measurement conditions, and screen capture data to files located on a USB memory device that is connected to the USB port on the front panel of the instrument. The data in the measurement data files and measurement conditions files can be read and used by your instrument or other FRA51615 instruments. The data can also be read by personal computers such as IBM PC/AT compatible machines.

The formats for the parameters contained in the measurement data files and measurement conditions files are listed in the following table.

【Parameter formats】

Symbol	Format	Example
(NR1)	Integer (numerical value)	123
(NR2)	Decimal point notation without exponent (numerical value)	0.075
(NR3)	Decimal point notation with exponent (numerical value)	4.99E+06
(CRD)	Text	ALL
(SRD)	Text enclosed in double quote marks	"No error"
{CRD1 CRD2 ..}	Any one of text or CRD1, 2, ...	{ON OFF}
(bool)	Boolean value	ON, OFF, 1, 0

6.2 Measurement data file format

The measurement data file is in text format (CSV) and can be used by text editors or spreadsheet software, etc. The file timestamp indicates the time at which the data was obtained by measurement, not the time the file was saved.

The structure of the measurement data file depends on whether or not the data was obtained by sequence measurement.

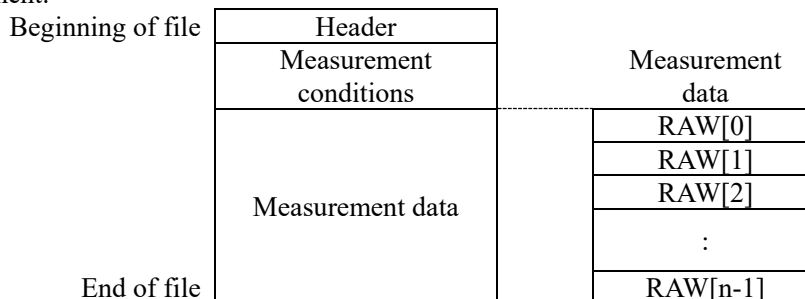

Figure 6-1 Structure of the measurement data file (no sequence measurement)

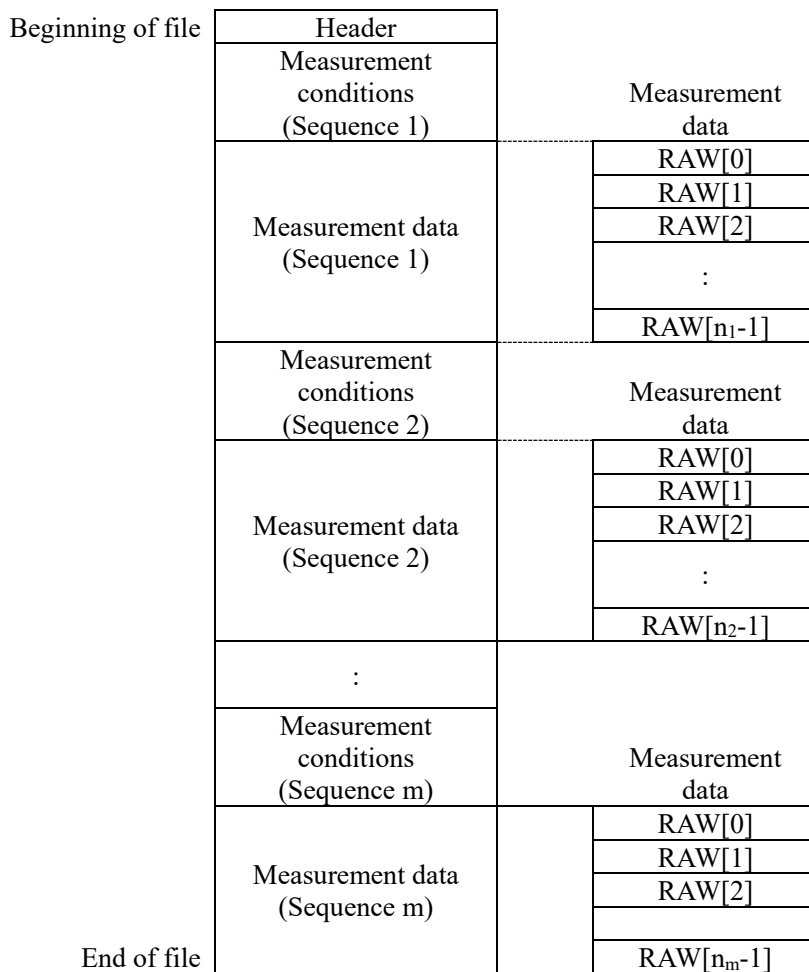

Figure 6-2 Structure of the measurement data file (with sequence measurement)

The measurement conditions part and the measurement data part have the same format, regardless of whether there is sequence measurement or not.

Table 6-1 Data file format (header)

Line number	Format (example)	Description
1	IDN, NF Corporation, FRA51615, 0123456, Ver1.00	Manufacturer, model, serial number, firmware version
2	FileFormatVer, 1.00	File format version
3	FileType, DATA	File type (measurement data)

Table 6-2 Data file format (measurement conditions part)

Relative line number	Format (example)	Description
+ 0	DataType, RAW	The type of data in the file is fixed as "RAW"
+ 1	DataNum, (NR1)	The number of data items (the sweep resolution + 1)
+ 2	Sequence, (NR1)	The sequence number. This is 0 if there is no sequence measurement.
+ 3	Direction, {UP DOWN}	The sweep direction
+ 4	Date, (CRD), (CRD)	Measurement start time in the format yyyy.mm.dd, hh:mm:ss
+ 5	OscAmplitude, (NR3)	The OSC amplitude (Vpk)
+ 6	OscDCbias, (NR2)	The OSC DC bias (V)
+ 7	OscOutputConnector, {FRONT REAR}	The DC bias output connector
+ 8	OscWaveform, {SINE SQUARE TRIANGLE}	The oscillator waveform
+ 9	SweepLowerFrequency, (NR2)	The sweep frequency lower limit (Hz)
+ 10	SweepUpperFrequency, (NR2)	The sweep frequency upper limit (Hz)
+ 11	SweepRes, (NR1), {LogSteps LinSteps}	The sweep resolution and sweep type
+ 12	MeasIntegration, (NR1 or NR3), {Cycle Sec}	The integration settings For cycles: NR1; for Sec: NR3
+ 13	MeasStartDelay, (NR1 or NR3), {Cycle Sec}	The measurement start delay settings For cycles: NR1; for Sec: NR3
+ 14	MeasDelay, (NR1 or NR3), {Cycle Sec}	The measurement delay settings For cycles: NR1; for Sec: NR3
+ 15	MeasCalculus, {-2 -1 0 1 2}	Differentiation and integration calculations -2: double integral -1: integral; 0: OFF 1: differential 2: second-order differential
+ 16	GraphTitleSet, (SRD)	The title of the graph
+ 17	GraphUnit, {GAIN IMPEDANCE}	The display unit
+ 18	GraphXaxis, {SWEEP Phase a R G }	The display item for the graph X axis
+ 19	GraphYaxis, {R-P dBR-P R-GD dBR-GD a-b R dBR b Z-P Y-P R-X G-B Cp-Rp Cp-D Cp-Q Cs-Rs Cs-D Cs-Q Lp-Rp Lp-Q Ls-Rs Ls-Q V-P I-P X -X B}	The display items for the graph Y1 and Y2 axes
+ 20	InputRangeCh1, {AUTO 600 300 100 30 10 3 1 300m 100m}	The CH1 measurement range

6.2 Measurement data file format

	30m}	
+ 21	InputRangeCh2, {AUTO 600 300 100 30 10 3 1 300m 100m 30m}	The CH2 measurement range

The line number of the first line of the measurement conditions part relative to the beginning of the file can be calculated with the formula shown below, denoting the number of data items (DataNum) for sequence number m as n_m .

$$\text{First line number for the measurement conditions part} = 4 + (21 + n_1) + (21 + n_2) + \dots + (21 + n_m)$$

If there is no sequence measurement ($m = 0$), the line number of the first line of the measurement conditions part would be 4.

Table 6-3 Data file formats (measurement data part)

Relative line number	Format (example)	Description
+ 0	(NR2), (NR3), (NR3), (NR3), (NR3), (NR3)	RAW[0] Frequency (Hz), V1 (Vrms), V2 (Vrms), θ (deg), Y1, Y2
+ 1	(NR2), (NR3), (NR3), (NR3), (NR3), (NR3)	RAW[1] Frequency (Hz), V1 (Vrms), V2 (Vrms), θ (deg), Y1, Y2
:	:	:
+ (n-1)	(NR2), (NR3), (NR3), (NR3), (NR3), (NR3)	RAW[n-1] Frequency (Hz), V1 (Vrms), V2 (Vrms), θ (deg), Y1, Y2

○ Concerning Y1 and Y2

These refer to the Y1 axis and Y2 axis of the graph. According to the graph settings at the time the file was saved, the contents are stored in the relative line number 19 (Graph GraphYaxis on the relative line number 19 on the measurement conditions part. Unless the graph X axis is SWEEP, Y1 is the X axis and Y2 is the Y axis.

6.3 Measurement conditions file format

The measurement conditions file is in text format (TXT) and can be accessed by text editors or spreadsheet software, etc. The file timestamp indicates the time the file was saved.

The structure of the measurement data file is illustrated below.

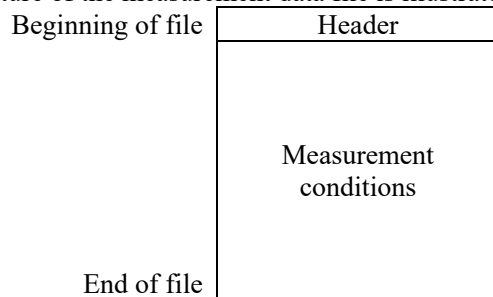

Figure 6-3 Structure of the measurement conditions file

Table 6-4 Measurement conditions file format (header)

Line number	Format (example)	Description
1	IDN, NF Corporation, FRA51602, 0123456, Ver1.00	Manufacturer, model, serial number, firmware version
2	FileFormatVer, 1.00	File format version
3	FileType, CON	File type (setting data)

Table 6-5 Measurement conditions file format (measurement conditions part)

Line number	Format (example)	Description
4	Sequence, (NR1)	The sequence sweep number (0 – 20)
5	OscFrequency, (NR2)	The oscillator frequency (Hz)
6	OscAmplitude, (NR3)	The OSC amplitude (Vpk)
7	OscDCbias, (NR2)	The OSC DC bias (V)
8	OscOutputConnector, {FRONT REAR}	The DC bias output connector
9	OscOnOffSync, {ASYNC SYNC}	Measurement synchronization
10	OscOnOffMode, {QUICK SLOW}	The on/off mode
11	OscStopMode, {QUICK SYNC}	The oscillator stop mode
12	OscWaveForm, {SINE SQUARE TRIANGLE}	The oscillator waveform
13	Osc10MHzRefIn, {DISABLE ENABLE}	Selects the reference clock Internal clock only (DISABLE), External clock enabled (ENABLE)
14	Osc10MHzRefOut, {DISABLE ENABLE}	Sets the reference clock output Disabled (DISABLE), Enabled (ENABLE)
15	AmplitudeCompression, {ON OFF}	Sets the amplitude compression function to enabled (ON) or disabled (OFF)

6.3 Measurement conditions file format

16	AmplitudeCompressionRefCh, {1 2}	Sets the amplitude compression function reference channel
17	AmplitudeCompressionRefLevel, (NR3)	Sets the amplitude compression function target level (Vrms)
18	AmplitudeCompressionOutputLimit, (NR3)	Sets the amplitude compression function output limit (Vrms)
19	AmplitudeCompressionTolerance, (NR1)	Sets the amplitude compression function permissible error (%)
20	AmplitudeCompressionRetry, (NR1)	Sets the amplitude compression function maximum number of retries
21	AmplitudeCompressionCorrectionFactor, (NR1)	Sets the amplitude compression function correction factor (%)
22	MeasIntegrationMode, {FIX SHORT MED LONG}	Sets the integration mode
23	MeasIntegrationType, {CYCLE SEC}	Sets the integration unit to cycles (CYCLE) or time (SEC)
24	MeasIntegrationCYCLE, (NR1)	Sets the integration period (cycles)
25	MeasIntegrationSEC, (NR3)	Sets the integration time (seconds)
26	MeasStartDelayType, {CYCLE SEC}	Sets the measurement start delay unit Period (CYCLE) or time (SEC)
27	MeasStartDelayCYCLE, (NR1)	Sets the measurement start delay. (cycles)
28	MeasStartDelaySEC, (NR3)	Sets the measurement start delay time (seconds)
29	MeasDelayType, {CYCLE SEC}	Sets the measurement delay unit Period (CYCLE) or time (SEC)
30	MeasDelayCYCLE, (NR1)	Sets the measurement delay period (cycles)
31	MeasDelaySEC, (NR3)	Sets the measurement delay time (seconds)
32	MeasSlopeCompensation, {ON OFF}	Sets the slope compensation function to enabled (ON) or disabled (OFF)
33	MeasCalculus, {-2 -1 0 1 2}	Sets the measurement differentiation and integration calculations -2: double integral -1: integral; 0: OFF 1: differential 2: second-order differential
34	SweepLowerFrequency, (NR2)	The sweep frequency lower limit (Hz)
35	SweepUpperFrequency, (NR2)	The sweep frequency upper limit (Hz)
36	SweepResType, {LOG LIN}	The sweep type
37	SweepRes, (NR1)	The sweep resolution
38	SweepRepeat, {ON OFF}	Sets the repeat measurement to enabled (ON) or disabled (OFF).
39	SweepFreqChangeMode,	The frequency change mode

6.3 Measurement conditions file format

	{ASYNC 0PHASE}	Immediate change (ASYNC), Change at 0° phase (0PHASE)
40	SlowSweep, {ON OFF}	Sets the slow sweep function to enabled (ON) or disabled (OFF).
41	SlowSweepChannel, {1 2}	Automatic high density sweep reference channel
42	SlowSweepVarType, {dBR R P a b}	Automatic high density sweep monitored parameter
43	SlowSweepVarDBR, (NR2)	Automatic high density sweep "dBR" threshold (dB)
44	SlowSweepVarR, (NR3)	Automatic high density sweep "R" threshold
45	SlowSweepVarP, (NR2)	Automatic high density sweep "P" threshold (deg)
46	SlowSweepVarA, (NR3)	Automatic high density sweep "a" threshold (Vrms)
47	SlowSweepVarB, (NR3)	Automatic high density sweep "b" threshold (Vrms)
48	GraphTitleSet, (SRD)	The title of the graph
49	GraphStyle, {SINGLE SPLIT}	The graph display style
50	GraphGridType, {OFF SOLIDLINE BROKENLINE}	The graph grid line type
51	GraphGridStyle, {OFF X X-Y1 X-Y2 X-Y1-Y2}	The graph grid display axis
52	GraphAxisType, {LIN LOG}, {LIN LOG}, {LIN LOG}	The graph display styles for the X, Y1, and Y2 axes
53	GraphUnit, {GAIN IMPEDANCE}	The graph display unit
54	GraphXaxis, {SWEEP Phase a R G}	The display item for the graph X axis
55	GraphYaxis, {R-P dBR-P R-GD dBR-GD a-b R dBR b Z-P Y-P R-X G-B Cp-Rp Cp-D Cp-Q Cs-Rs Cs-D Cs-Q Lp-Rp Lp-Q Ls-Rs Ls-Q V-P I-P X -X B}	The display items for the graph Y1 and Y2 axes
56	GraphTrace, {ON OFF}, {ON OFF}, {ON OFF}, {ON OFF}	Select the data trace for graph display In order of measurement data Y1, measurement data Y2, reference data Y1, reference data Y2
57	GraphAnalysisMode, {CH1/CH2 CH2/CH1 CH1 CH2}	Analysis mode
58	GraphPhaseRange, {0 1 2 3}	Phase display range ±180° (0), 0 to + 360° (1), -360 to 0° (2), UNWRAP (3)
59	GraphPhaseAperture, (NR1)	Aperture size (group delay calculation)

6.3 Measurement conditions file format

60	GraphScaleMode, {AUTO FIX}	Graph axis scale mode
61	GraphScaleX, (NR3), (NR3)	Graph X axis range lower limit to upper limit
62	GraphScaleY1, (NR3), (NR3)	Graph Y1 axis range lower limit to upper limit
63	GraphScaleY2, (NR3), (NR3)	Graph Y2 axis range lower limit to upper limit
64	MarkerMode, {OFF MAIN MAIN&DELTA}	Select the marker display mode
65	MarkerSearchValueX, (NR3)	Marker X search value
66	MarkerSearchValueDeltaX, (NR3)	Marker Δ X search value
67	MarkerSearchValueY1, (NR3)	Marker Y1 search value
68	MarkerSearchValueDeltaY1, (NR3)	Marker Δ Y1 search value
69	MarkerSearchValueY2, (NR3)	Marker Y2 search value
70	MarkerSearchValueDeltaY2, (NR3)	Marker Δ Y2 search value
71	MarkerAutoSearch, {OFF XMAX XMIN XPEAK XBOTTOM Y1MAX Y1MIN Y1PEAK Y1BOTTOM Y2MAX Y2MIN Y2PEAK Y2BOTTOM X Y1 Y2 DELTA X DELTA Y1 DELTA Y2}	Marker auto search mode
72	InputRangeCh1, {AUTO 600 300 100 30 10 3 1 300m 100m 30m}	Sets the CH1 measurement range
73	InputRangeCh2, {AUTO 600 300 100 30 10 3 1 300m 100m 30m}	Sets the CH2 measurement range
74	InputOverLevel, (NR3), (NR3)	Sets the over-level detection level for CH1 and CH2
75	InputOverActionBeep, {ON OFF}	Sets the beep to sound or not sound when input over-level is detected
76	InputOverActionSweepStop, {ON OFF}	Sets whether or not the sweep operation stops when input over-level is detected
77	InputWeightingFactor, (NR3), (NR3)	Sets the input weight coefficient for CH1 and CH2
78	InputInvert, {ON OFF}	Sets input phase inversion to on or off
79	CalEqualizing, {ON OFF}	Enables or disables the equalizing function
80	CalOpenCorrection, {ON OFF}	Open correction Enabled/disabled
81	CalShortCorrection, {ON OFF}	Short correction Enabled/disabled
82	CalLoadCorrection, {ON OFF}	Load correction Enabled/disabled
83	CalLoadFormat, {Cs-D Cp-D Rp-Cp Rs-Ls Rs-X Z-P}	Load correction Load standard value format

84	CalLoad1,(NR3),(NR3),(NR3)	Load standard value 1 Frequency Hz, impedance Z, phase P
85	CalLoad2,(NR3),(NR3),(NR3)	Load standard value 2 Frequency Hz, impedance Z, phase P
86	CalLoad3,(NR3),(NR3),(NR3)	Load standard value 3 Frequency Hz, impedance Z, phase P
87	CalLoad4,(NR3),(NR3),(NR3)	Load standard value 4 Frequency Hz, impedance Z, phase P
88	CalLoad5,(NR3),(NR3),(NR3)	Load standard value 5 Frequency Hz, impedance Z, phase P
89	CalLoad6,(NR3),(NR3),(NR3)	Load standard value 6 Frequency Hz, impedance Z, phase P
90	CalLoad7,(NR3),(NR3),(NR3)	Load standard value 7 Frequency Hz, impedance Z, phase P
91	CalLoad8,(NR3),(NR3),(NR3)	Load standard value 8 Frequency Hz, impedance Z, phase P
92	CalLoad9,(NR3),(NR3),(NR3)	Load standard value 9 Frequency Hz, impedance Z, phase P
93	CalLoad10,(NR3),(NR3),(NR3)	Load standard value 10 Frequency Hz, impedance Z, phase P
94	CalPortExtension, {ON OFF}	Port extension Enabled/disabled
95	CalPortExtensionZ0,(NR3)	Port extension Characteristic impedance Ω
96	CalPortExtensionElectricalLength, (NR2)	Port extension Electrical length (m)
97	OthersDateTime, (CRD), (CRD)	The date and time the file was saved in the format yyyy.mm.dd, hh:mm:ss

6.4 Screen capture file format

The LCD screen capture data is saved to a file in uncompressed BMP (Microsoft Windows Bitmap Image) format with a pixel resolution of 800×600 and 16 million colors. The size of one file is about 1.9 MB.

7. Troubleshooting

7.1	Error messages.....	7-2
7.1.1	Errors that occur when the instrument power is turned on	7-2
7.1.2	Errors that occur during panel operation.....	7-3
7.1.3	Errors that occur during measurement	7-5
7.1.4	Other errors	7-5
7.2	Information messages.....	7-6
7.2.1	Messages presented at start-up	7-6
7.2.2	Messages presented during operation	7-6
7.3	Quick diagnosis.....	7-8

7.1 Error messages

The main errors that occur during the self-diagnosis process that is performed when the instrument is turned on, during panel operations, and during normal measurement are described in this section, along with their causes and how to deal with them.

If the instrument requires repair, please contact the NF Corporation or its authorized agent. When requesting repair, please include the error code (error number) and a description of the error message that was displayed.

An example error message is presented below. The error code is the number that follows "Message:" in the information window and begins with a minus sign. In the example shown below, the error code is "-2048". Please note that there are message codes (see "7.2 Information messages") that have the same number as an error code but do not have the minus sign.

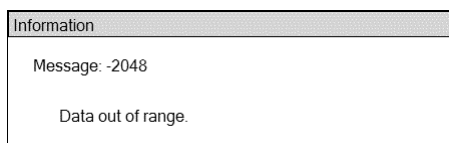

There are error messages that are not described in this manual, but which may occur in events, such as instrument malfunction due to strong external noise.

Error messages that are not described in this manual may also appear during unusual operations such as updating the instrument firmware. If other manuals are provided, refer to them as well.

Concerning errors that only occur during remote control operation, refer to the "Remote Control Instruction Manual".

7.1.1 Errors that occur when the instrument power is turned on

When the power is turned on, the instrument self-diagnosis routine is executed. The error messages that may appear when a problem occurs during that time are described in Table 7-1.

Table 7-1 Power-up errors

No.	Error message	Description and cause	Handling
-1024	Settings load error. Initialize and start up.	The settings were initialized because of a failure to load settings from the resume memory.	Turn the power off and on again. If the error occurs repeatedly, there may be a problem with the instrument that requires repair.

7.1.2 Errors that occur during panel operation

The errors that may occur during panel operation are listed in Table 7-2.

Table 7-2 Panel operation errors

No.	Error message	Description and cause	Handling
-2048	Data out of range.	The set parameter value lies outside the specified range.	Set a value that is within the correct range.
-2049	Settings conflict.	There is a violation of constraints among multiple settings.	Set a value that is within the correct range.
-2050	Not allowed character.	An invalid character has been entered.	Enter only valid characters.
-2051	String length error.	The permitted number of characters has been exceeded.	Reduce the number of characters to the permitted number.
-2052	Execution error.	Execution was prevented by constraint conflicts among multiple settings.	Change the settings so that the constraint conditions are satisfied.
-2053	Syntax error.	There is an error in the numerical input.	Input a correct expression
-3073	Insufficient data for equalize correction. It may not work correctly.	There is insufficient equalizing correction data. The equalizing correction may not succeed.	Prepare a sufficient amount of correction data.
-3074	Insufficient data for open correction. It may not work correctly.	The open correction data is invalid. The open correction function may not produce correct results.	Store correct open correction data.
-3075	Insufficient data for short correction. It may not work correctly.	The short correction data is invalid. The short correction function may not produce correct results.	Store correct short correction data.
-3076	Insufficient data for load correction. It may not work correctly.	The load correction data is invalid. The load correction function may not produce correct results.	Store correct load correction data.
-3077	Can't execute calibration. Please turn off the oscillator output.	The calibration process cannot begin because the oscillator output is turned on.	Turn the oscillator output off and start the calibration again.

Table 7-2 Panel operation errors (continued)

No.	Error message	Description and cause	Handling
-5120	Printer didn't respond.	There was no response from the printer.	Connect the specified printer.
-5121	Out of paper	The printer has run out of paper.	Refill the printer paper supply.
-6144	Can't access USB storage.	Access to the USB memory device failed.	<ul style="list-style-type: none"> • Connect a proper USB memory device. • Make sure the USB memory device is securely connected.
-6145	There is already a file of the same name.	A file of the same name already exists, so the specified name cannot be used to rename the file.	Specify a different file name.
-6146	USB storage overflow.	There isn't sufficient available space on the USB memory device.	Insert a USB memory device that has sufficient available space.
-6147	File load error due to illegal header.	The file could not be loaded because it is an invalid file (invalid header).	Specify a valid file.
-6148	File load error due to illegal data.	The file could not be loaded because it contains invalid data.	Specify a correctly formatted file.
-6149	Failed to save.	The process of saving the file to the USB memory device failed.	Remove the read-only attribute from the file.
-6150	Failed to load.	The process of reading the file from the USB memory device failed.	Specify an undamaged file.
-6151	Failed to delete.	The process of deleting the file from the USB memory device failed.	Remove the read-only attribute from the file.
-6152	Can't load empty memory.	The process of reading the measurement data failed because the internal memory is empty.	Specify in internal memory that is not empty.

7.1.3 Errors that occur during measurement

The errors that may occur during measurement are listed in Table 7-3.

Table 7-3 Errors that occur during measurement

No.	Error message	Description and cause	Handling
-3072	Measurement terminated due to measurement points over 20,001.	The number of measurement points exceeded the limit of 20,001, so measurement was stopped.	When performing sequence measurement, reduce the number of measurement points at each step. When performing automatic high density sweep measurements, change the threshold setting.

7.1.4 Other errors

Errors that may occur irregularly during use of this instrument are listed in Table 7-4.

Table 7-4 Other errors

No.	Error message	Description and cause	Handling
-7168	Measurement state mismatch.	An error was detected in internal communication (measurement section).	If the front panel or touch panel become unresponsive, turn off the power and then turn it on again. If this problem occurs frequently, the instrument may be malfunctioning. In that case, contact the NF Corporation or its authorized agent.
-7169	Measurement section no response.	There was no response from the measurement section in internal communication.	
-7170	System section no response.	There was no response from the UI section in internal communication.	
-7171	Remote section no response.	There is no response from the remote interface section in internal communication.	
-7172	Internal error.	There was an internal processing error.	

7.2 Information messages

Measurements that may be displayed when operations or measurements are completed normally are explained in this section.

An example information message is presented below. The message code follows "Message:" in the information window. In the example shown below, the message code is "2048". Please note that message codes differ from error codes in that error codes are preceded by a minus sign. (See "7.1 Error messages".)

Information
Message: 2048
Done.

7.2.1 Messages presented at start-up

Messages that may be presented when the power is turned on are listed in Table 7-5.

Table 7-5 Messages presented at start-up

No.	Message	Description
1024	Settings have been initialized due to firmware update.	All settings were initialized after a firmware update was performed.
1025	Last shutdown caused by power failure.	The previous time the instrument was powered down, power was turned off without first entering the standby state, so the instrument started up with the settings loaded from setting memory No.1.

7.2.2 Messages presented during operation

The messages that may be presented during normal operation are listed in Table 7-6.

Table 7-6 Messages presented during operation

No.	Message	Description
100	Are you sure you want to reset the current LAN settings?	Confirmation for a LAN reset operation.
101	Interface setting in progress.	The remote interface set-up is in progress.
2048	Done.	The operation has been completed.
3072	Are you sure you want to delete the MEAS TRACE?	Confirmation for clearing the measurement data trace.
3073	Are you sure you want to execute the "CALIBRATION"?	Confirmation for executing calibration.

Table 7-6 Messages presented during operation (continued)

No.	Message	Description
4096	Done. <Graph Min Phase> to <Graph Max Phase> Press the Cancel key to exit the execution mode.	During the execution of phase shift
4097	Done. Press the Cancel key to exit the execution mode.	During marker search
6144	Are you sure you want to save the current settings to the <dist>?	Confirmation for saving to a setting data file.
6145	Are you sure you want to load the <file> to the current settings?	Confirmation for reading from a setting data file.
6146	Are you sure you want to delete the <file>?	Confirmation for deleting a setting data file.
6147	Are you sure you want to save the MEAS TRACE to the <dist>?	Confirmation for saving to a measurement data file.
6148	Are you sure you want to load the <file> to the <dist1>?	Confirmation for reading from a measurement data file.
6149	Are you sure you want to delete the <file>?	Confirmation for deleting a measurement data file.
6150	<file> already exists. Are you sure you want to replace it?	Confirmation for overwriting a file in USB memory.
7168	Are you sure you want to reset the current settings?	Confirmation for initialization.
7169	Do you want to execute the "TOUCH ADJUST"?	Confirmation for beginning touch panel adjustment.
7170	Are you sure you want to initialize all the current settings?	Confirmation for initializing to factory settings.
7171	USB connected.	A USB memory device (or printer) has been connected to the instrument.
7172	USB disconnected.	A USB memory device (or printer) has been removed from the instrument.

<dist>: This is the destination for saving data. For internal memory, it is replaced with "memory number X", where X is 1 to 20. For USB memory, it is replaced with "USB storage".

<dist1>: Depending on the save destination, it is replaced with "MEAS TRACE", "REF TRACE", "Equalize correction memory", "Open correction memory", "Short correction memory", or

"Load correction memory".

<file>: This represents the source from which data is read. For internal memory, it is replaced with "memory number X", where X is 1 to 20. For USB memory, it is replaced with a file name.

7.3 Quick diagnosis

If you believe the instrument is malfunctioning, use Table 7-7 to identify the problem and understand how to deal with it. If you are still unable to solve the problem or if the method described fails to restore the instrument to normal functioning, please contact the NF Corporation or its authorized agent.

Table 7-7 Troubleshooting

Problem	Possible cause	Handling
The instrument does not power up.	The power cord is not properly plugged in.	Make sure that the power cord is securely inserted into the connectors.
	The power source does not conform to the specifications.	Use mains that satisfies the specifications.
	External noise or other such factors are causing abnormal operation.	Install the instrument in a location that is free from conditions that affect the normal operation of the instrument.
Panel operations are not possible	The instrument is operating in remote state.	Press the LOCAL key. If the instrument is in the remote with lockout state, this operation will not be effective. In that case, use the remote controller to return the instrument to local state.
The instrument does not operate as described in the instruction manual.	The instrument has not been initialized.	Most of the explanation in the manual assumes that the instrument has been initialized. From the menus, select 【Other】 —[RESET] and then press the ENTER button.
Printing with the specified printer does not work.	The printer is out of paper.	Refill the printer paper supply.
An error occurs during calibration.	Measurement accuracy is being decreased by external noise.	Place the instrument in a location where the conditions do not affect the calibration.
	The calibration cables have not been connected properly.	Make sure that the BNC adapter and cables are properly connected to the OSC-CH1-CH2 connectors. For more information on the connections, refer to "5.9.1 Calibration".

8. Maintenance

8.1	Introduction	8-2
8.2	Daily maintenance	8-3
8.3	Storage, repacking, and transportation	8-3
8.4	Checking the version number	8-3
8.5	Performance test.....	8-4
8.5.1	Introduction.....	8-4
8.5.2	Oscillator frequency accuracy.....	8-6
8.5.3	Oscillator AC amplitude accuracy	8-7
8.5.4	Oscillator AC amplitude and frequency characteristics	8-8
8.5.5	Oscillator DC bias accuracy (OUTPUT OSC).....	8-9
8.5.6	DC bias accuracy (DC BIAS).....	8-10
8.5.7	Analyzer IMRR	8-11
8.5.8	Analyzer dynamic range	8-12
8.5.9	Analyzer measurement error	8-13
8.6	Calibration	8-14

8.1 Introduction

The maintenance items required to keep this instrument in good condition for use are listed below.

- Operational inspection Check that the instrument is functioning properly.
- Performance test Check that the instrument is operating at the rated performance levels.
- Adjustment and calibration If the instrument is not performing according to the specifications, the NF Corporation will adjust and calibrate the instrument to restore performance.
- Repair If adjustment and calibration fail to improve performance, the NF Corporation will investigate the cause, locate the failure, and repair the instrument.

This instruction manual describes how you can easily check for proper operation of the instrument and test performance. For more advanced inspection, adjustment, calibration, and repair, please contact the NF Corporation or its authorized agent.

 **WARNING**

There are locations of high-voltage inside this product. Do not remove the cover of this instrument.

Inspection of the interior of this instrument should not be performed by anyone other than service technicians that have been trained to avoid hazards.

8.2 Daily maintenance

Before use, install this instrument in a location that satisfies the installation conditions. For information on the installation conditions, refer to "2.2.2 Installation environment".

The front panel of this instrument is made of a plastic material. Take care not to damage it with anything that is sharp or hot.

Wipe the panel or case with a soft cloth to clean it as necessary. To remove stubborn soiling, wipe with a cloth that has been dampened with a mild detergent solution and squeezed well to remove excess liquid. Do not use organic solvents such as paint thinner or benzene, or a chemically-treated cloth. Doing so may result in degradation, a cloudy appearance, or peeling of paint.

If the surface of the LCD touch panel become soiled, wipe it off with absorbent cotton or a soft cloth. Using detergents or organic solvents may result in degradation or a cloudy appearance and should be avoided.

8.3 Storage, repacking, and transportation

This instrument should be stored in a location that satisfies the storage conditions. For information on storage conditions, refer to "2.2.2 Installation environment".

When packing the instrument for transportation, etc., use a box that is sufficiently strong and large enough to provide a surplus of space. Fill the box with packing material that can withstand the weight of the equipment so that the instrument is fully protected.

Make sure that the package is handled with care to avoid strong shocks during transport.

8.4 Checking the version number

Because the product continues to be improved, instruments may have the same model name but may different firmware versions. Instruments that have different firmware versions may differ in operation.

When a problem arises, be sure to include the version number with the description of the problem.

We may guide you to update the instrument firmware on the NF Corporation website.

You can check the version after startup in the following way.

From the menus, select **【Other】** – **【SYSTEM】** to check the firmware version. The number to the right of "VERSION" is the version number.

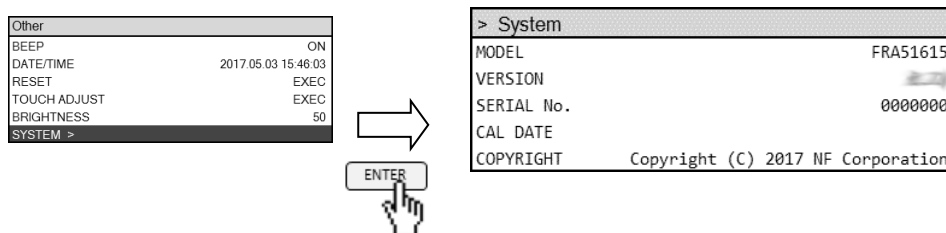

8.5 Performance test

8.5.1 Introduction

The performance test is a part of preventive maintenance and is performed to prevent degradation of instrument performance. The testing is done for the acceptance inspection, periodic inspections, and whenever it is necessary to check performance, such as after repair. This section describes a simple test that can be done with commercially available measuring instruments.

More advanced testing is available at charge and can be requested of the NF Corporation or its authorized agent.

If the performance test indicates that the instrument does not satisfy the specifications, calibration or repair is required. In that case, please contact the NF Corporation or its authorized agent.

1) The test environment

The performance test should be performed under the following conditions.

- Ambient temperature 23 ±5°C
- Ambient humidity 20 to 70% RH, no condensation
- Power supply voltage 100 to 230 VAC ±10%, however 250 V or less
- Warm-up time 30 minutes or more

2) Preparation for testing

Before doing the test, initialize the settings and calibrate the instrument. To initialize the instrument, select **【Other】** – **[RESET]** from the menus. For more information, refer to "**■ Initialization**" in "4.2.1 Common operations". To calibrate the instrument, select **【Calib.】** – **[CALIBRATION]** from the menus. For more information, refer to "5.9.1 Calibration".

3) Testing equipment

The measurement instruments needed for checking operation and testing performance are listed as below.

Product	Required specifications	Example models
Frequency counter	Accuracy: ± 1 ppm or better	53131A + option 001 (Keysight)
Digital multimeter	AC voltage (true rms) (100 mV to 10 V, 100 Hz to 10 kHz) Accuracy: $\pm 0.1\%$ DC voltage Accuracy: $\pm 0.1\%$ (100 mV to 10 V)	34401A (Keysight)
RF voltmeter	AC voltage (true rms) (100 mV to 10 V) Accuracy: $\pm 0.5\%$ (1 kHz to 100 kHz) Accuracy: $\pm 1.0\%$ (100 kHz to 1 MHz) Accuracy: $\pm 5.0\%$ (1 MHz to 15 MHz)	URE3 (Rohde & Schwarz)
Other	BNC-BNC coaxial cable 50 Ω , RG-58A/U BNC 50 Ω feed-thru terminator (Power rating is 0.25 W or more)*1 BNC-banana adapter BNC adapter (provided) BNC short plug BNC-alligator clip cable	$\times 2$ $\times 1$ $\times 1$ $\times 1$ $\times 1$ $\times 1$

*1: Not required if the input impedance of the RF voltmeter is 50 Ω .

8.5.2 Oscillator frequency accuracy

Before performing each of the following measurements, initialize this instrument.

- This instrument : Set the frequency to 1.0 MHz.
Measuring instrument : Use a frequency counter and set the gate time to 10 seconds.
Connections : Connect the OUTPUT OSC connector of this instrument to the frequency counter with a coaxial cable.
Measurement method : Read the measured value from the frequency counter.

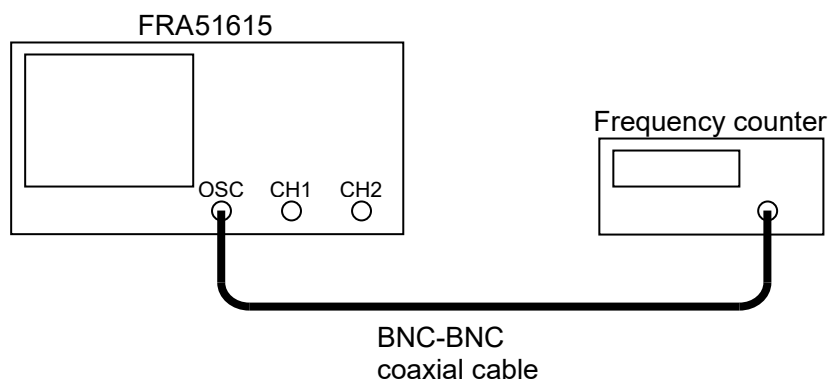

Judgment

- Passing range : 0.999990 kHz to 1.000010 MHz
Measured value : _ . _ _ _ _ _ MHz

8.5.3 Oscillator AC amplitude accuracy

- This instrument : Set the frequency to 1 kHz.
- Measuring instrument : Set the digital multimeter to AC voltage mode (true RMS).
- Connections : Connect the OUTPUT OSC connector of this instrument to the digital multimeter with a coaxial cable.
- Measurement method : Set the AC amplitude of this instrument to 100 mVpk, 1 Vpk, and 10 Vpk, and read the AC voltage from the multimeter.
- The amplitude accuracy is calculated from the measured AC voltage with the formula shown below.

$$\text{Amplitude accuracy (dB)} = 20 \times \log_{10} \frac{\text{Measured AC voltage (Vrms)}}{\text{Set AC amplitude (Vpk)}} + 3.01$$

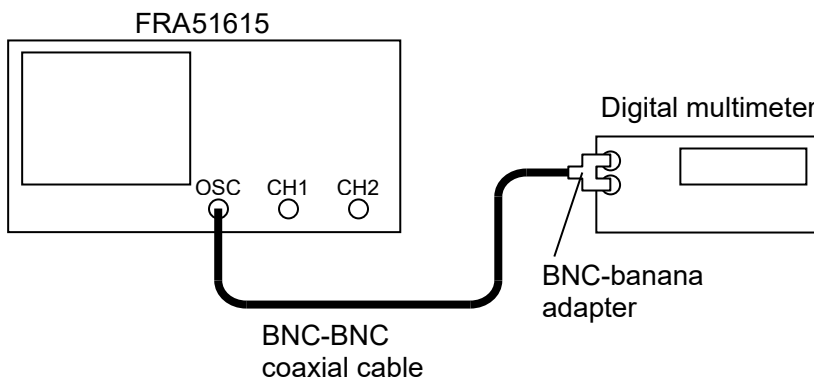

Judgement

AC amplitude setting	Measured AC voltage	Amplitude accuracy	Passing range
100 mVpk	. . . mVrms	. . . dB	-0.30 to +0.30 dB
1 Vpk	. . . Vrms	. . . dB	-0.30 to +0.30 dB
10 Vpk	. . . Vrms	. . . dB	-0.30 to +0.30 dB

8.5.4 Oscillator AC amplitude and frequency characteristics

This instrument: Set the frequency to 1 kHz and the AC amplitude to 100 mVpk.

Measuring instrument : Set the broadband digital multimeter to AC voltage mode (true RMS).

Connections : Connect the OUTPUT OSC connector of this instrument to the RF voltmeter with a coaxial cable via a BNC feed-thru terminator.

Measurement method : Set the oscillating frequency of the instrument to 1 kHz, 100 kHz, 1 MHz, and 15 MHz, and read the AC voltage value from the RF voltmeter.

The amplitude-frequency characteristic referenced to the AC voltage measurement at 1 kHz is calculated from the measured AC voltage with the formula shown below.

$$\begin{aligned} & \text{Amplitude - frequency characteristic (dB)} \\ & = 20 \times \log_{10} \frac{\text{Measured AC voltage at each frequency (Vrms)}}{\text{Measured AC voltage at 1 kHz (Vrms)}} \end{aligned}$$

Set the AC amplitude of this instrument to 1 Vpk, and 10 Vpk, and obtain the frequency-amplitude characteristic in the same way, with the AC voltage measured at 1 kHz as the reference value.

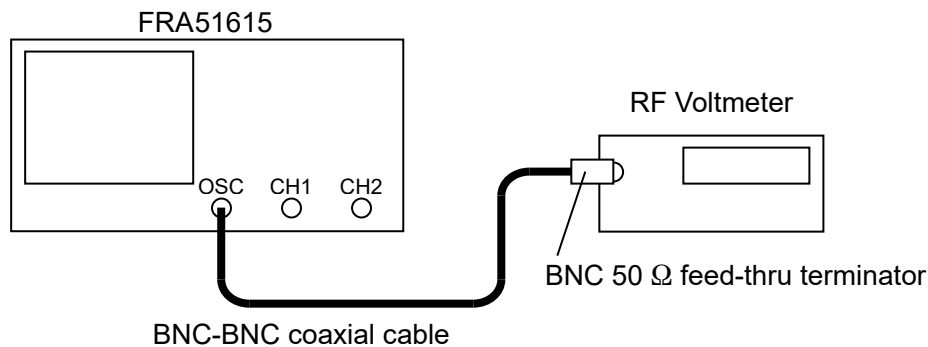

Judgement

AC amplitude setting	Frequency setting	Measured AC voltage	AC amplitude frequency characteristic	Passing range
100 mVpk	1 kHz	. . mVrms	0.00 dB	(reference)
	100 kHz	. . mVrms	. . dB	-0.30 to +0.30 dB
	1 MHz	. . mVrms	. . dB	-1.0 to +1.0 dB
	15 MHz	. . mVrms	. . dB	-3.0 to +3.0 dB
1 Vpk	1 kHz	. . Vrms	0.00 dB	(Reference)
	100 kHz	. . Vrms	. . dB	-0.30 to +0.30 dB
	1 MHz	. . Vrms	. . dB	-1.0 to +1.0 dB
	15 MHz	. . Vrms	. . dB	-3.0 to +3.0 dB
10 Vpk	1 kHz	. . Vrms	0.00 dB	(Reference)
	100 kHz	. . Vrms	. . dB	-0.30 to +0.30 dB
	1 MHz	. . Vrms	. . dB	-1.0 to +1.0 dB
	15 MHz	. . Vrms	. . dB	-3.0 to +3.0 dB

8.5.5 Oscillator DC bias accuracy (OUTPUT OSC)

- This instrument : Set the AC amplitude to 0 Vpk.
- Measuring instrument : Set the digital multimeter to DC voltage mode.
- Connections : Connect the OUTPUT OSC connector of this instrument to the digital multimeter with a coaxial cable.
- Measurement method : Set the DC bias of this instrument to -10 V , 0 V , and $+10\text{ V}$, and read the DC voltage from the multimeter.

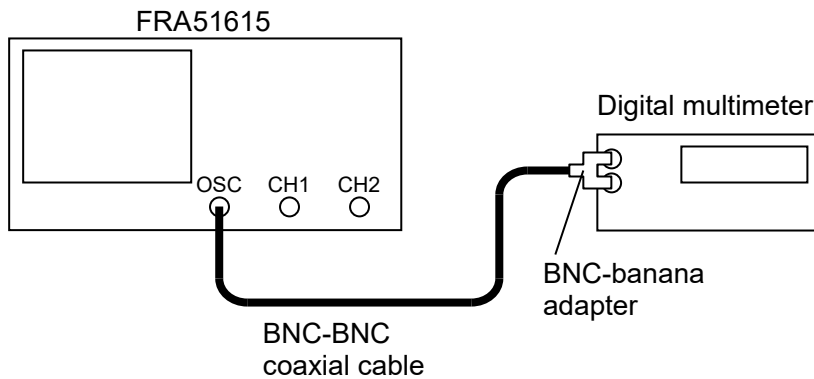

Judgement

DC bias setting	DC voltage value	Passing range
-10 V	$- . \text{ V}$	$-10.130\text{ to }-9.870\text{ V}$
0 V	$. \text{ mV}$	$-30.0\text{ to }+30.0\text{ mV}$
$+10\text{ V}$	$+ . \text{ V}$	$+9.870\text{ to }+10.130\text{ V}$

8.5.6 DC bias accuracy (DC BIAS)

- This instrument : Set the DC bias output to the DC BIAS connector on the rear panel.
- Measuring instrument : Set the digital multimeter to DC voltage mode.
- Connections : Connect the DC BIAS connector of this instrument to the digital multimeter with a coaxial cable.
- Measurement method : Set the DC bias of this instrument to -10 V , 0 V , and $+10\text{ V}$, and read the DC voltage from the multimeter.

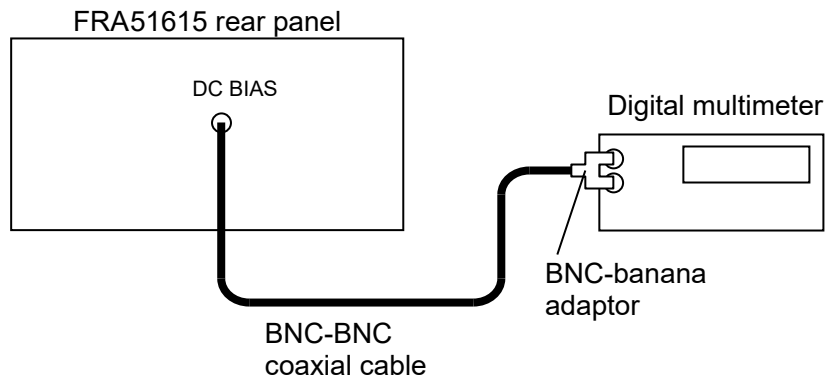

Judgement

DC bias setting	DC voltage value	Passing range
-10 V	$- . \text{ V}$	$-10.130\text{ to }-9.870\text{ V}$
0 V	$. \text{ mV}$	$-30.0\text{ to }+30.0\text{ mV}$
$+10\text{ V}$	$+ . \text{ V}$	$+9.870\text{ to }+10.130\text{ V}$

8.5.7 Analyzer IMRR

- This instrument : Set the oscillation frequency to 60 Hz and the AC amplitude to 10 Vpk.
Set the number of integrations to 200 cycles.
Set the analysis mode to CH2/CH1.
- Measuring instrument : (none)
- Connections : Connect a BNC short plug to the CH1 connector of this instrument and connect a BNC adapter to the OUTPUT OSC connector.
Connect one side of the BNC adapter to CH1 and the instrument enclosure.
Connect the other side of the BNC adapter to CH2 (when measuring the IMMR of CH1).
- Measurement method : Use the instrument to perform a SPOT measurement and read the measurement value displayed on the LCD screen (gain in dB).
When the CH1 IMRR measurement has been completed, switch the connections for CH1 and CH2, change the analysis mode to CH1/CH2.
Then perform the SPOT measurement and read the measurement value (gain in dB) again.

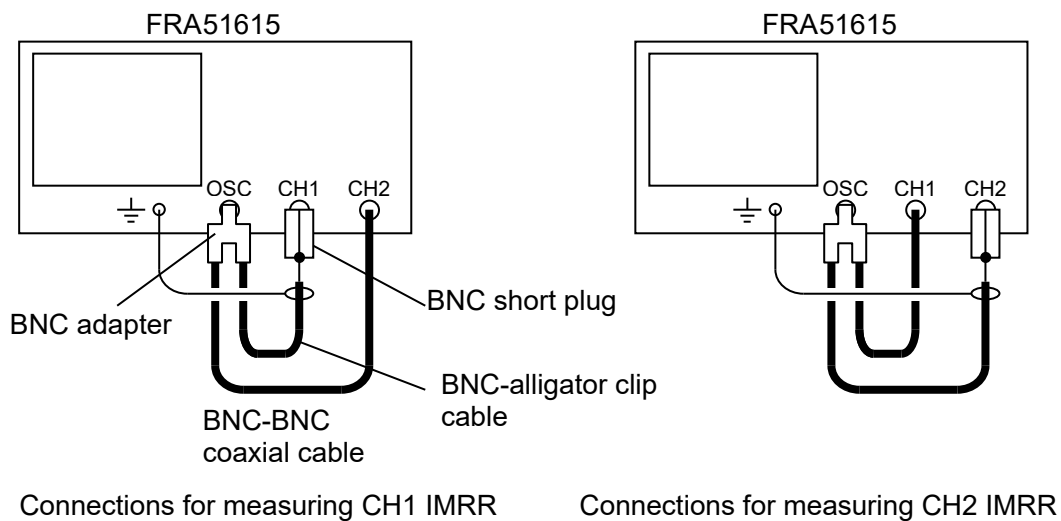

Judgement

Connections	Analysis mode	Measurement value	Passing range
CH1 IMRR	CH2/CH1	. dB	120.0 dB or more
CH2 IMRR	CH1/CH2	. dB	120.0 dB or more

8.5.8 Analyzer dynamic range

- This instrument : Set the oscillator AC amplitude to 10 Vpk and the sweep frequency to from 10 Hz to 15 MHz.
Set the number of integrations to 300 cycles and the analysis mode to CH2/CH1.
- Measuring instrument : (none)
- Connections : Connect the BNC short plug to the CH1 connector. Connect the OUTPUT OSC to CH2.
- Measurement method : Perform upsweep measurements with the instrument, and read the minimum gain values in the ranges from 10 Hz or more up to 1 MHz and from 1 MHz or more to 15 MHz from the LCD screen.
After completing the measurements, change to the connections for measuring the dynamic range of CH2 and set the analysis mode to CH1/CH2. Perform a sweep measurement and read the minimum gain values for each range from the LCD screen.

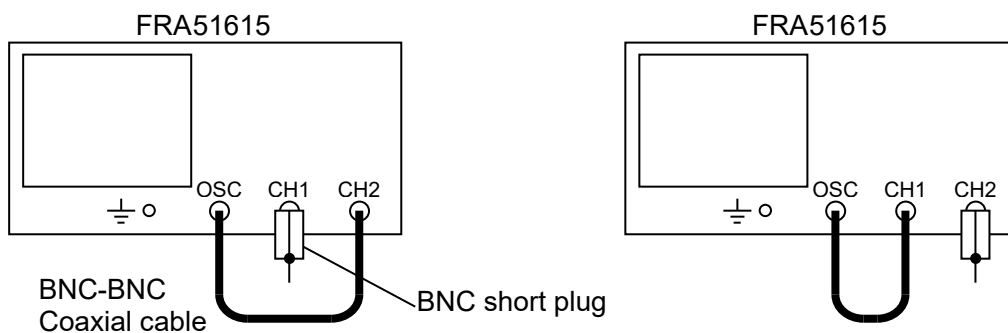

Connections for measuring the dynamic range of CH1

Connections for measuring the dynamic range of CH2

Judgement

Connections	Analysis mode	Frequency range	Minimum measurement value	Passing range*1
CH1 dynamic range	CH2/CH1	$10 \text{ Hz} \leq f < 1 \text{ MHz}$. dB	140.0 dB or more
		$1 \text{ MHz} \leq f \leq 15 \text{ MHz}$. dB	80.0 dB or more
CH2 dynamic range	CH1/CH2	$10 \text{ Hz} \leq f < 1 \text{ MHz}$. dB	140.0 dB or more
		$1 \text{ MHz} \leq f \leq 15 \text{ MHz}$. dB	80.0 dB or more

*1: This value may not be satisfied due to the effects of electromagnetic noise in the environment or other such factors. However, the test will be passed if most of the data that results from the sweep measurement does satisfy the value.

8.5.9 Analyzer measurement error

This instrument : Set the AC amplitude to 4.2 V_{pk}, the measurement range for both channels to 3 V, and the sweep frequency to from 10 Hz to 15 MHz.
Set the number of integrations to 30 cycles.

Measuring instrument : (none)

Connections : Connect the BNC adapter to the OUTPUT OSC connector of the instrument. Connect one side of the BNC to the CH1 connector and connect the other side to the CH2 connector.

Measurement method : Perform an upsweep measurement with the instrument, and read the maximum and minimum values of the measured values displayed on the LCD screen (gain in dB and phase in degrees) for the ranges of 200 kHz and below, 1 MHz and below, 2 MHz and below, 5 MHz and below, and 15 MHz and below.

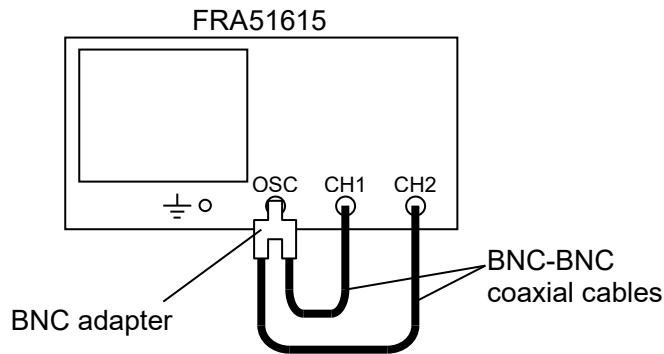

Judgement

Frequency range	Measured value	Passing range
$10 \text{ Hz} \leq f \leq 200 \text{ kHz}$	(minimum) ___ . ___ to (maximum) ___ . ___ dB (minimum) . ___ to (maximum) . ___ deg	-0.010 to +0.010 dB -0.06 to + 0.06 deg
$200 \text{ kHz} < f \leq 1 \text{ MHz}$	(minimum) ___ . ___ to (maximum) ___ . ___ dB (minimum) . ___ to (maximum) . ___ deg	-0.025 to +0.025 dB -0.15 to +0.15 deg
$1 \text{ MHz} < f \leq 2 \text{ MHz}$	(minimum) ___ . ___ to (maximum) ___ . ___ dB (minimum) . ___ to (maximum) . ___ deg	-0.10 to +0.10 dB -0.60 to +0.60 deg
$2 \text{ MHz} < f \leq 5 \text{ MHz}$	(minimum) ___ . ___ to (maximum) ___ . ___ dB (minimum) . ___ to (maximum) . ___ deg	-0.20 to +0.20 dB -1.20 to +1.20 deg
$5 \text{ MHz} < f \leq 15 \text{ MHz}$	(minimum) ___ . ___ to (maximum) ___ . ___ dB (minimum) . ___ to (maximum) . ___ deg	-0.50 to +0.50 dB -3.0 to +3.0 deg

8.6 Calibration

If the performance test reveals that the instrument is not performing according to the specifications, the NF Corporation will adjust or calibrate the instrument to restore performance.

If calibration is required, please contact the NF Corporation or its authorized agent.

Adjustment or calibration that is performed outside the warranty period is available for a charge.

9. Specifications

9.1	Oscillator section	9-2
9.2	Analysis input section	9-4
9.3	Measurement processing section	9-6
9.4	Analysis processing section	9-9
9.5	Display section	9-16
9.6	Memory	9-16
9.7	External memory	9-17
9.8	External input/output function	9-17
9.9	Miscellaneous specifications	9-19

Nominal, Typical, Supplemental, and Approximate values

These values are supplemental data do not represent a guarantee of the performance of this product.

Unless stated specifically otherwise, the assumed conditions are sinusoidal waveform, a temperature of 23°C ±5°C, no more than 12 hours has passed since calibration has been performed after a warm-up period of at least 30 minutes, and change in ambient temperature of not greater than ±5°C after calibration. Unless stated specifically otherwise, the shell (outer cover) and signal grounds are connected to the instrument enclosure (not isolated).

9.1 Oscillator section

The oscillator section can output an AC signal and the DC bias for measurement. The AC signal is output from the OSC connector on the front panel. The DC bias can be output from either the OSC connector on the front panel or the DC BIAS OUT connector on the rear panel. You can select the connector from which the DC bias is output. If the OSC connector on the front panel is selected for DC bias output, the signal output from the OSC connector is a composite of the AC signal and the DC bias.

9.1.1 Front panel OSC

- Connector Insulated BNC connector (front panel, OSC)
- Output waveform Sinusoidal, square, or triangular
- Frequency
 - Setting range 10 μHz to 15 MHz
The quality of square and triangular waveforms deteriorates at frequencies above 100 kHz.
 - Setting resolution 10 μHz
 - Accuracy ±10 ppm
Conditions: The instrument is operating on the internal reference clock.
- AC signal amplitude
 - Setting range 0 to 10 Vpk Conditions: No load
 - Setting resolution 3 digits or 0.01 mVpk, whichever is greater
 - Accuracy ±0.3 dB
Conditions: sinusoidal waveform, 1 kHz, 100 mVpk to 10 Vpk, no load
 - Frequency characteristic ±0.3 dB or less (100 kHz or less)
±1 dB or less (1 MHz or less)
±3 dB or less (15 MHz or less)
Conditions: 1 kHz reference, sinusoidal waveform, 100 mVpk to 10 Vpk, 50 Ω load
 - Distortion (sinusoidal) 0.2% or less, supplementary value
Conditions: 100 kHz or less, BW 500 kHz, 10 Vpk output
- DC bias
 - The DC bias output is superimposed on the AC signal only when the DC bias output is set to the OSC connector on the front panel of the instrument.
 - Setting range -10 V to 10 V
 - Setting resolution 10 mV
 - Accuracy ±(1% of DC bias setting | + 2% of AC amplitude settings + 30 mV)
Conditions: sinusoidal waveform, no load

- Output impedance 50 Ω ±2% Conditions: 1 kHz
- Maximum output (AC + DC)
 - Voltage ±10 V Conditions: no load
 - Current ±100 mA
- Output control
 - QUICK (immediately changes to the set voltage or to 0 V)
 - SLOW (changes to the set voltage or to 0 V gradually over a period of about 10 seconds)
 - Function for turning off at 0° phase
 - Function for changing the frequency at 0° phase
 - It is possible to turn the AC and DC on / off at the same time or to turn off the AC independently.
 - It is possible to turn on automatically at the start of measurement and to turn off automatically at the end of measurement.
- Sweep
 - Sweep density 3 to 20,000 steps/sweep
 - Sweep type Linear or log, selectable
 - Sweep direction Up or down, selectable
 - Pressing the front panel START **UP** key or **DOWN** key starts the sweep.
 - Sweep time Conditions: Integration cycle 1, delay 0 s, the sweep time per frequency point for when a fixed range is set for both analysis input channels (supplementary value)

For when the sweep density is 3 to 200 steps/sweep

Frequency f	Sweep time per frequency point
$10 \mu\text{Hz} \leq f < 1.36 \text{ kHz}$	$(1/f) \text{ s}$
$1.36 \text{ kHz} \leq f < 50 \text{ kHz}$	1 ms to 1.5 ms
$50 \text{ kHz} \leq f$	0.5 ms

When the sweep density is 201 to 20,000 steps/sweep, add 1 ms to the values in the above table.

- Isolation 600 V CAT II or 300 V CAT III (BNC grounded to the enclosure)
 - Below 45 Hz: 600 Vpk (AC + DC)
 - 45 Hz to 100 kHz: 600 Vrms (AC)
 - 100 kHz to 3 MHz: 600 Vrms (AC) × 100 ÷ F
 where F is frequency in units of kHz.
 - 3 MHz to 15 MHz: 20 Vrms (AC)
 - At 45 Hz and above, the voltage including DC must be 600 Vrms or less and 849 Vpk or less.
- Capacitance relative to the enclosure 150 pF or less

9.1.2 Rear panel DC BIAS OUT

The DC bias is output only when the DC BIAS OUT is set as the output connector for the DC bias.

- Connector BNC connector (rear panel, DC BIAS OUT)
- Setting range -10 V to 10 V Conditions: no load
- Setting resolution 10 mV
- Accuracy $\pm(1\% \text{ of DC bias setting } | + 30 \text{ mV})$
- Output resistance $600 \Omega \pm 2\%$

9.2 Analysis input section

- Input channels 2
- Connectors Insulated BNC connector (front panel, CH1 and CH2)
- Input impedance $1 \text{ M}\Omega \pm 2\%$, $20 \text{ pF} \pm 5\text{pF}$
- Measurement range 30 mV to 600 V (rms), and AUTO. CH1 and CH2 can be set independently.

Measurement range and maximum measurement input voltage

Measurement range (rms)	30 mV	100 mV	300 mV	1 V	3 V
Maximum measurement input voltage	$\pm 42.5 \text{ mV}$	$\pm 142 \text{ mV}$	$\pm 425 \text{ mV}$	$\pm 1.42 \text{ V}$	$\pm 4.25 \text{ V}$

Measurement range (rms)	10 V	30 V	100 V	300 V	600 V AUTO
Maximum measurement input voltage	$\pm 14.2 \text{ V}$	$\pm 42.5 \text{ V}$	$\pm 142 \text{ V}$	$\pm 425 \text{ V}$	$\pm 849 \text{ V}$

There is restricted by frequency. See "● Maximum input voltage" below.

- Maximum input voltage 600 V CAT II or 300 V CAT III (BNC signal to BNC ground)
 - Below 45 Hz: 600 Vpk (AC + DC)
 - 45 Hz to 100 kHz: 600 Vrms (AC)
 - 100 kHz to 3 MHz: $600 \text{ Vrms (AC)} \times 100 \div F$
where F is frequency is units of kHz.
 - 3 MHz to 15 MHz: 20 Vrms (AC)

At 45 Hz and above, the voltage including DC must be 600 Vrms or less and 849 Vpk or less.
- IMRR (isolation mode rejection ratio)
 - 120 dB or more (DC to 60 Hz)
 - Conditions: Input shorted, integration 200 cycles or more, and common mode voltage 10 Vpk
- Isolation 600 V CAT II or 300 V CAT III (BNC ground to enclosure)
 - Below 45 Hz: 600 Vpk (AC + DC)
 - 45 Hz to 100 kHz: 600 Vrms (AC)
 - 100 kHz to 3 MHz: $600 \text{ Vrms (AC)} \times 100 \div F$
where F is frequency in units of kHz.
 - 3 MHz to 15 MHz: 20 Vrms (AC)

At 45 Hz and above, the voltage including DC must be 600 Vrms or less and 849 Vpk or less.

- Capacitance relative to enclosure 200 pF or less
- Frequency range 10 μ Hz to 15 MHz
- Maximum measurement voltage
 - 600 Vrms
 - When the provided signal cable is used.
 - When the other signal cables are used, the voltage is restricted to the rated voltage of the cable or to 600 Vrms, whichever is less.
- Over-level detection
 - Setting range 0 to 600 Vrms
 - Setting resolution 3 digits
 - Processing Over lamp lights.
 - Buzzer warning sound (can be turned on / off)
 - Stop sweep measurement (can be turned enable / disable)

Over-level detection occurs when the amplitude or maximum measurement input voltage that is set as described above is exceeded. (See "9.2 Analysis input section, ● Measurement range".)
- Dynamic range 140 dB (10 Hz to 1 MHz)
- 80 dB (1 MHz to 15 MHz)
- The maximum measurable gain, limited by the noise floor and cross talk between channels.
- Conditions: The larger channel input is at least 10 Vpk, integration is 300 cycles, and the measurement range is AUTO for both channels.
- Input weighting Setting range is 0 to 1.00000E+12, resolution 6 digits or 1E-12
- CH1 and CH2 are set independently
- The weight is a coefficient that is applied to measurement results of CH1 or CH2 to correct the attenuation or gain of probes, amplifiers, or other such equipment that is connected to the instrument.
- Phase inversion function ON or OFF
- This function is used when the polarity of connection to the circuit being tested is reversed. This is set to on when the optional "PA-001-0368 impedance measurement adapter" is used.

The isolation specifications for between the oscillator (OSC) and analysis input (CH1 or CH2) and the instrument enclosure is illustrated in Figure 9-1. The isolation specifications between the OSC, CH1, and CH2 signal connectors is illustrated in Figure 9-2.

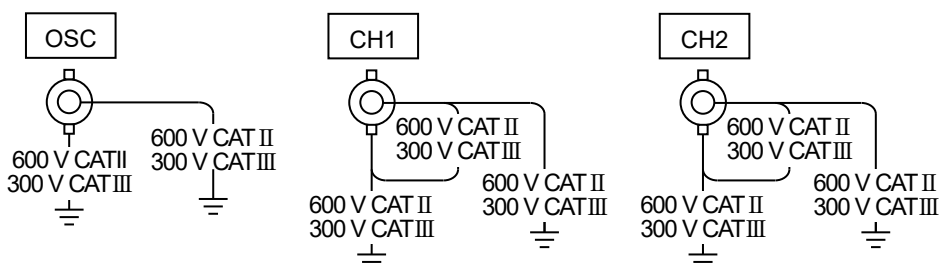

Figure 9-1 Isolation voltage specifications relative to the enclosure

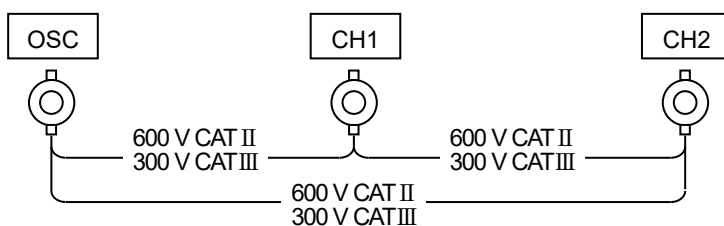

Figure 9-2 Isolation voltage specifications between signal connectors

When cables or probes, etc. are connected to the instrument, the voltage is restricted to the withstand voltage specifications of the connected cable or probe, etc. or to the withstand voltage of the instrument, whichever voltage is lowest.

9.3 Measurement processing section

- Measurement operations

SPOT	Do a measurement at the current frequency (no sweep)
UP SWEEP	Do a sweep measurement (in order of increasing frequency)
DOWN SWEEP	Do a sweep measurement (in order of decreasing frequency)
REPEAT	Do measurements repeatedly
SINGLE	Do a single measurement

- Measurement delay function

This function delays the beginning of a measurement after the frequency is changed.

Delay can be set either a duration or a number of cycles.

Time settings

Setting range	0 to 9,990 s
Setting resolution	3 digits or 0.1 ms, whichever is greater

Cycle settings (set in units of measurement frequency cycle)

Setting range	0 to 9,999 cycles, but no more than 9,990 s
Setting resolution	1 cycle

- Start delay function

This function delays the beginning of a measurement only from the start of a sweep or spot measurement.

Delay can be set either a duration or a number of cycles.

Time settings

Setting range	0 to 9,990 s
Setting resolution	3 digits or 0.1 ms, whichever is greater
Cycle settings (Set in units of measurement frequency cycles)	
Setting range	0 to 9,999 cycles, but no more than 9,990 s
Setting resolution	1 cycle

● Integration function

This function performs integration on measurement data to remove the effects of noise. Measurement repetition can be set either a duration or a number of cycles.

Time setting

Setting range	0 to 9,990 s (The measurement is performed for at least 1 cycle, regardless of the setting.)
Setting resolution	3 digits or 0.1 ms, whichever is greater
Cycle settings (set in units of cycles, taking the signal acquisition time ^{*1} to be one cycle)	
Setting range	1 to 9,999 cycles
Setting resolution	1 cycle

*1: The signal acquisition time is one cycle of the measurement frequency f when f is approximately 1 kHz or less. For higher frequencies, the signal acquisition time ranges between 1.0 ms and 20 ms, depending on the value of f and the cycle setting.

● Automatic integration function

This function repeats the integration process until the variation in the measurement values falls below a set value. However, integration is stopped if the value specified in "9.3 Measurement processing section, ● Integration function" is exceeded.

Setting	FIX, SHORT, MED, or LONG.
FIX:	The integration is performed with the settings specified in "9.3 Measurement processing section, ● Integration function", regardless of the variation and measurement values.
Other than FIX:	The integration is performed until the variation becomes small, but the measurement time becomes longer in the order of SHORT < MED < LONG.

*1: The signal acquisition time is one cycle of the measurement frequency f when f is approximately 1 kHz or less. For higher frequencies, the signal acquisition time ranges between 1.0 ms and 20 ms, depending on the value of f and the cycle setting.

● Amplitude compression

This function automatically adjusts the oscillator output amplitude so that the amplitude of the signal input to the reference channel satisfies the target amplitude that is set. This function maintains a constant amplitude for the measurement system to prevent saturation and damage to the measurement system.

Reference channel	CH1 or CH2
Target amplitude setting	
Setting range	1 μ V to 600 Vrms (value before input weight processing)
Setting resolution	3 digits
Voltage limit for the oscillator output	
Setting range	1 mV to 10 Vpk
Setting resolution	3 digits

Allowable error

Setting range 1 to 100%

Setting resolution 1%

Maximum number of retries

Setting range 1 to 9,999

Setting resolution 1

Correction factor

Setting range 1 to 100%

Setting resolution 1%

- Automatic high density sweep (slow sweep)

This function automatically increases the sweep density in the region just before and after a point where there is a large change in the measurement data.

Reference channel CH1 or CH2

Variation

a, b, R

Setting range 0 to 600 V_{rms} (before input weighting)Setting resolution 3 digits or 1 μ V, whichever is greater

dBR

Setting range 0 to 1000 dB

Setting resolution 0.01dB

Phase

Setting range 0 to 180°

Setting resolution 0.01°

- Sequence measurement function

This function performs measurements according to the content of a measurement condition memory.

When an up sweep measurement is performed, the first up sweep is performed over the frequency range that is set in memory number 1. The next up sweep is performed over the range that is set in memory number 2, and so on continuously up to the memory number that has been set as the upper limit memory number.

For down sweep measurement, the first down sweep is performed over the range set in the memory number specified by the upper limit memory number. The next down sweep is performed over the range that is set in the next lower memory number and so on continuously down to memory number 1.

Upper limit memory number 1 to 20

Setting resolution 1

9.4 Analysis processing section

The SI prefixes (k, M, etc.) that are placed before units of measurement and the scales they represent are a (10⁻¹⁸), f (10⁻¹⁵), p (10⁻¹²), n (10⁻⁹), μ (10⁻⁶), m (10⁻³), k (10³), M (10⁶), and G (10⁹).

9.4.1 Common items

- Display unit Gain (ratio, unitless number) or impedance
- Measurement accuracy (fixed range)

Measurement accuracy Relative accuracy + Calibration accuracy

Relative accuracy ± (| Basic accuracy | + | Dynamic accuracy | + | Inter-range accuracy × N|),
where N is | number of measurement range steps between channels |.

Example: If the measurement ranges of each channels are 300 V_{rms} and 1 V_{rms}, N is 5 (300 V to 100 V to 30 V to 10 V to 3 V to 1 V).

Calibration accuracy The accuracy of external equipment that is connected to the instrument, such as a shunt resistor or probe, or the accuracy of the calibration standard equipment.

Basic accuracy Upper: gain (ratio); Middle: impedance Z; Lower: phase

Measurement range (rms)	Frequency			
	≤ 100 kHz	≤ 200 kHz	≤ 1 MHz	≤ 2 MHz
600 V	±0.2 dB ±2.4 % ±1.2°	—	—	—
300 V	±0.1 dB ±1.2 % ±0.6°		—	—
100 V	±0.05 dB ±0.58 % ±0.3°		—	—
30 V : 30 mV	±0.01 dB ±0.12 % ±0.06°		±0.025 dB ±0.29 % ±0.15°	±0.1 dB ±1.2 % ±0.6°

Measurement range (rms)	Frequency	
	≤ 5 MHz	≤ 15 MHz
10 V : 30 mV	±0.2 dB ±2.4 % ±1.2°	±0.5 dB ±5.9 % ±3.0°

Conditions: At least 30 cycles of integration, fixed measurement range for both channels, and both channels have the same range. The gain, impedance and phase error for when the signal input is at the full scale of the measurement range for both channels.

*For the cells that contain only " — ", the measurement range exceeds the maximum input voltage (see "9.2 Analysis input section, ● Maximum input voltage"), so either the measurement is not possible or there is no accuracy specification for it.

Dynamic accuracy Upper: gain (ratio); Middle: impedance Z; Lower: phase

Measurement range (rms)	Frequency				Measurement range (rms)
	≤ 100 kHz	≤ 200 kHz	≤ 1 MHz	≤ 2 MHz	
600 V		—	—	—	600 V
300 V		—	—	—	300 V
100 V		±0.1 dB	—	—	100 V
30 V		±1.2 %			30 V
:		±0.6°			±0.2 dB
300 mV				±1.2°	300 mV
100 mV					100 mV

Measurement range (rms)	Frequency	
	≤ 5 MHz	≤ 15 MHz
600 V	—	—
:		
30 V		
10 V	±0.2 dB	±0.5 dB
:	±2.4 %	±6.0 %
100 mV	±1.2°	±3.0°

Conditions: At least 30 cycles of integration, fixed measurement range for both channels, and both channels have the same measurement range. Gain, impedance and phase variation for when the signal level changes from full-scale of measurement range to 1/10. The input signal level is 1:1 or 1:0.1 between channels.

*For the cells that contain only " — ", the measurement range exceeds the maximum input voltage (see "9.2 Analysis input section, ● Maximum input voltage"), so either the measurement is not possible or there is no accuracy specification for it.

Inter-range accuracy Upper: gain (ratio); Middle: impedance Z; Lower: phase

Measurement range (rms)	Frequency			
	≤ 100 kHz	≤ 200 kHz	≤ 2 MHz	≤ 15 MHz
600 V	—			
300 V	±0.1 dB ±1.2 % ±0.6°	—	—	—
	±0.05 dB ±0.58 % ±0.3°	±0.1 dB ±1.2 % ±0.6°	—	—
100 V	±0.05 dB ±0.58 % ±0.3°		—	—
30 V	±0.05 dB ±0.58 % ±0.3°			—
10 V	±0.05 dB ±0.58 % ±0.3°			
3 V	±0.05 dB ±0.58 % ±0.3°			
1 V	±0.05 dB ±0.58 % ±0.3°			
300 mV	±0.05 dB ±0.58 % ±0.3°			
100 mV	±0.05 dB ±0.58 % ±0.3°			
	—			

Conditions: At least 30 cycles of integration and fixed measurement range for both channels.

The gain, impedance and phase error for when the measurement range difference between channels is 1, the input signal levels of both channels are equal, and equal to the range full scale level of the smaller range.

*For the cells that contain only " — ", the measurement range exceeds the maximum input voltage (see "9.2 Analysis input section, ● Maximum input voltage"), so either measurement is not possible or there is no accuracy specification for it.

● Measurement accuracy (auto-range)

Measurement accuracy Relative accuracy + Calibration accuracy

Relative accuracy $\pm (| \text{Basic accuracy} | + | \text{Dynamic accuracy} |)$

Calibration accuracy The accuracy of external equipment that is connected to the instrument, such as a shunt resistor or probe, or the accuracy of the calibration standard equipment.

Basic accuracy Upper: gain (ratio); Middle: impedance Z; Lower: phase

Signal level (rms)	Frequency			
	≤ 100 kHz	≤ 200 kHz	≤ 1 MHz	≤ 2 MHz
7 V	± 0.02 dB ± 0.24 % $\pm 0.12^\circ$	± 0.02 dB ± 0.24 % $\pm 0.12^\circ$	± 0.05 dB ± 0.58 % $\pm 0.3^\circ$	± 0.1 dB ± 1.2 % $\pm 0.6^\circ$

Signal level (rms)	Frequency	
	≤ 5 MHz	≤ 15 MHz
7 V	± 0.2 dB ± 2.4 % $\pm 1.2^\circ$	± 0.5 dB ± 5.9 % $\pm 3.0^\circ$

Conditions: At least 30 cycles of integration, auto-range for both channels. The gain, impedance and phase error for when the input signal level is the same for both channels.

Dynamic accuracy Upper: gain (ratio); Middle: impedance Z; Lower: phase

Signal level (rms)	Frequency				Signal level (rms)
	≤ 100 kHz	≤ 200 kHz	≤ 1 MHz	≤ 2 MHz	
≤ 600 V		—	—	—	≤ 600 V
≤ 300 V		± 0.1 dB	—	—	≤ 300 V
≤ 60 V		± 1.2 %		—	≤ 60 V
≤ 30 V		$\pm 0.6^\circ$		± 0.2 dB	≤ 30 V
≤ 300 mV				± 2.4 %	≤ 300 mV
100 mV \leq				$\pm 1.2^\circ$	100 mV \leq

Signal level (rms)	Frequency	
	≤ 5 MHz	≤ 15 MHz
≤ 20 V	± 0.2 dB ± 2.4 % $\pm 1.2^\circ$	± 0.5 dB ± 6.0 % $\pm 3.0^\circ$
100 mV \leq		

Conditions: At least 30 cycles of integration, measurement range is AUTO for both channels.

The gain, impedance and phase variation for when input signal level with the greater signal level channel changes from 7 Vrms to the value of the table, when the input signal level between channel is 1:1 or 1:0.1.

*For the cells that contain only " — ", the measurement range exceeds the maximum input voltage (see "9.2 Analysis input section, ● Maximum input voltage"), so either the measurement is not possible or there is no accuracy specification for it.

● Error correction function

Calibration This function corrects for measurement errors that arise within the instrument itself. It is executed with the provided calibration cables and BNC adapter, connected to the OSC, CH1 and CH2 connectors.

9.4.2 GAIN

- Analysis modes

Ratio	CH1/CH2, CH2/CH1
Amplitude	CH1, CH2

- Graph types

Bode plot	A graph with the frequency on the X axis
Nyquist plot	A graph with the real part on the X axis and the imaginary part on the Y axis
Nichols plot	A graph with gain on the X axis and phase on the Y axis

- Measurement data items and display range

The actual measured values and display range for each parameter are constrained by the measurement range and the frequency, etc.

dBR (gain dB) ± 999.999 dB, resolution 0.001 dB

θ (phase)

$\pm 180^\circ$ -180.000° to 179.999° , resolution 0.001°

0 to 360° 0.000° to 359.999° , resolution 0.001°

-360 to 0° -360.000° to -0.001° , resolution 0.001°

UNWRAP -9999.999° to $+9999.999^\circ$, resolution 0.001°

GD (group delay) $\pm(1$ a to 999.999 G)s or 0 s, resolution 6 digits or 1 a

(when the analysis mode setting is CH1/CH2 or CH2/CH1)

R (absolute gain) 0 to 999.999 G (ratio, unitless number), resolution 6 digits or 1 a

a (real part of gain) $\pm(1$ a to 999.999 G) or 0 (ratio, unitless number), resolution 6 digits or 1 a

b (imaginary part of gain)

$\pm(1$ a to 999.999 G) or 0 (ratio, unitless number), resolution 6 digits or 1 a

(when the analysis mode setting is CH1 or CH2)

R (amplitude) 0 Vrms to 999.999 GVrms, resolution 6 digits or 1 aVrms

a (real part of amplitude)

$\pm(1$ a to 999.999 G) Vrms or 0 Vrms, resolution 6 digits or 1 aVrms

b (imaginary part of amplitude)

$\pm(1$ a to 999.999 G) Vrms or 0 Vrms, resolution 6 digits or 1 aVrms

- Measurement accuracy for other than R and θ

Accuracy of measurement items other than R (absolute gain) and θ (phase). Where defined the accuracy of R as R_a %, the accuracy of θ as θ_a , and the measurement value of θ as θ_x , specified in "9.4.1

Common items, ● Measurement accuracy (fixed range) and ● Measurement accuracy (AUTO range)".

GD (group delay) $\pm\{\theta_a / (APT \times 360)\}$ s

APT: The unit for aperture in the group delay display is hertz

a (real part of gain) $\pm(R_a / \cos \theta_x)\%$

b (imaginary part of gain) $\pm(R_a / \sin \theta_x)\%$

- Error correction function

Equalizing This function obtains the characteristics for the measurement target alone by measuring the frequency characteristics of the measurement system (sensors, cables, etc.) in advance and then eliminate that error component for the measurement system when the actual measurements are performed later.

9.4.3 IMPEDANCE

- Voltage and current input Voltage is measured as the measurement amplitude at CH1 and current is measured as the measurement amplitude at CH2.

- Analysis modes

Impedance	CH1 / CH2
Admittance	CH2 / CH1
Voltage	CH1
Current	CH2

- Graph types

Bode plot	A graph with the frequency on the X axis.
Nyquist plot	A graph with the real part on the X axis and the imaginary part on the Y axis.
Cole-cole plot	A graph with the real part on the X axis and the imaginary part on the Y axis. However, the upper side of Y axis is minus.

- Measurement data items and display range

The actual measured values and display range for each parameter are constrained by the measurement range and the frequency, etc.

Z (impedance)	0 Ω to 999.999 G Ω , resolution 6 digits or 1 a Ω
R, X (resistance, reactance)	$\pm(1 \text{ a to } 999.999 \text{ G})\Omega$ and 0 Ω , resolution 6 digits or 1 a Ω
Y (admittance)	0 S to 999.999 GS, resolution 6 digits or 1 aS
G, B (conductance, susceptance)	$\pm(1 \text{ a to } 999.999 \text{ G})\text{S}$ and 0 S, resolution 6 digits or 1 aS
Ls, Lp (inductance)	$\pm(1 \text{ a to } 999.999 \text{ G})\text{H}$ and 0 H, resolution 6 digits or 1 aH
Cs, Cp (capacitance)	$\pm(1 \text{ a to } 999.999 \text{ G})\text{F}$ and 0 F, resolution 6 digits or 1 aF
Rs, Rp (resistance)	$\pm(1 \text{ a to } 999.999 \text{ G})\Omega$ and 0 Ω , resolution 6 digits or 1 a Ω

The suffixes s and p for L, C, and R respectively represent the serial component and parallel components.

V (voltage)	0 Vrms to 999.999 GVrms, resolution 6 digits or 1 aVrms
I (current)	0 Vrms to 999.999 GARms, resolution 6 digits or 1 aARms
θ (phase)	
$\pm 180^\circ$	-180.000° to 179.999° , resolution 0.001 $^\circ$
0 to 360°	0.000° to 359.999° , resolution 0.001 $^\circ$
-360 to 0°	-360.000° to -0.001° , resolution 0.001 $^\circ$
UNWRAP	-9999.999° to $+9999.999^\circ$, resolution 0.001 $^\circ$
D (dissipation factor)	$\pm(0.00001 \text{ to } 99999.9)$ and 0 (unitless number)
Q (quality factor)	$\pm(0.00001 \text{ to } 99999.9)$ and 0 (unitless number)

● Measurement accuracy for other than Z and θ

Accuracy of measurement items other than Z (impedance) and θ (phase). Where defined the accuracy of Z as Z_a %, and the measurement value of θ as θ_x , specified in "9.4.1 Common items, ● Measurement accuracy (fixed range) and ● Measurement accuracy (AUTO range)".

Y	$\pm Z_a$ %
R, Rs, Rp, G	$\pm(Z_a / \cos \theta_x)$ %
X, B, Ls, Lp, Cs, Cp	$\pm(Z_a / \sin \theta_x)$ %
D	$\pm(0.01 \times Z_a)$

When $|D_x| \leq 0.1$; D_x is the measured value of D.

The measurement accuracy of D is not a percent value, but the value itself.

Q	$\pm \{(Q_x^2 \times P_e / (1 - Q_x \times P_e))\}$
---	---

When ($|Q_x| \geq 10$) and ($|Q_x| \times P_e \leq 0.1$).

Q_x is the measured value of Q. $P_e = 0.01 \times Z_a$.

The measurement accuracy of Q is not a percent value, but the value itself.

● Error correction function

Open correction	Corrects the residual admittance
Short correction	Corrects the residual impedance
Load correction	Corrects the voltage-current conversion coefficient of the measurement system

Load standard value Standard values can be entered for up to 10 frequency points.

Port extension	Corrects the error due to phase delay in cables for 2-port measurements.
Characteristic impedance	

Setting range 1.00 Ω to 999 Ω , resolution 3 digits

Electrical length

Setting range 0.000 m to 999.999 m, resolution 0.001 m

Slope compensation	ON/OFF
--------------------	--------

This function performs analysis that is unaffected by the DC level for signals that have a superimposed DC level that varies linearly over time. It is used when measuring the impedance of batteries during charging and discharging.

9.5 Display section

- Display unit 8.4-inch color TFT-LCD (SVGA) with touch screen
- Graph display styles
 - SINGLE One graph is displayed on the screen.
 - SPLIT Two graphs are displayed on the screen, one above the other.
- Graph axis setting The X, Y1, and Y2 axes can each be set to Lin, Log individually.
- Data traces Reference data trace (REF) or measurement data trace (MEAS)
- Auto scaling On or off
 - This function automatically optimizes the graph display scale.
- Marker display
 - Main marker The main marker is displayed on the data, and the data value at the position specified by the marker is displayed.
 - Delta marker The delta marker and the main marker are displayed on the data, and the difference between the data values indicated by the two markers is displayed.
- Marker search function
 - Search items
 - Max, Min Search for the maximum and minimum values
 - Peak, Bottom Search for the peak (maximal) and the bottom (minimal) values
 - NextPeak Search for the next peak
 - NextBottom Search for the next bottom
 - Value Search for the marker value
 - △Value Search for the difference between the delta marker and the main marker values
 - XValue Search for frequency
 - It is possible to automatically perform a search at the end of a sweep measurement.
- Display of the measurement conditions for the measured data
 - The main measurement conditions for when the data that is being displayed was measured are displayed.
- Title display It is possible to specify titles for the measurement data and reference data.

9.6 Memory

- Measurement data (MEAS) The data from the sweep measurement
 - Up to 20 sets of data can be stored in internal memory.
- Reference data (REF) Data that can be displayed on a graph together with the measurement data (MEAS). This can be measurement data or data loaded from a USB memory device. The display can be turned on or off.
- Error correction data Data that is used for equalizing
- Measurement conditions 20 sets

Except for data that is not stored in internal memory, measurement data is retained, even if the power is turned off.

9.7 External memory

- Media USB memory device
- Connections Front panel, USB-A connector
- File system FAT
- Memory contents Measurement conditions, measurement data (MEAS), reference data (REF), and screen capture data
- Screen capture function
 - File format MS Windows bitmap file
(extension: .BMP, image size: 800 × 600)
 - Approximate file size 1.9 MB
 - File name FRAnnn.BMP
(nnn: three digit number, incremented automatically, initial value can be set)
 - File save destination Root folder

9.8 External input/output function

- GPIB
 - Standards conformance IEEE488.1 and IEEE488.2
 - Connector Rear panel, GPIB connector
 - Interface functions SH1, AH1, T6, L4, SR1, RL1, PP0, DC1, DT0, C0, E1
- USB
 - Specification USB 2.0 HighSpeed
 - Connector Rear panel, USB-B connector
 - Device class TMC
- LAN
 - Specification 10/100Base-T
 - Connector Rear panel, RJ-45 connector
 - Protocols TCP/IP (socket communication)
- RS-232
 - Baud rate 4800 / 9600 / 19200 / 38400 / 57600 / 115200 / 230400 bps
At baud rate that exceed 19200 bps, the characteristics of the cable and controller may prevent communication.
 - Flow control None / software (X-ON/X-OFF) / hardware (RTS/CTS)
- External monitor
 - For connecting a projector, external monitor, etc.
 - Connector Rear panel, VGA (mini D-sub15 pin, female)
 - Signal 800 × 600 pixels (SVGA), analog RGB component video signal
 - Horizontal frequency 37.9 kHz
 - Vertical frequency 60.3 Hz
 - Scanning Progressive

- Reference clock input

Connector	Rear panel, BNC connector
Input impedance	300 Ω (nominal), AC coupling
Frequency	10 MHz \pm 100 ppm or under
Input waveform	Sinusoidal or square
Input voltage	0.5 Vp-p to 5 Vp-p
Maximum nondestructive input voltage	10 Vp-p
Signal grounding	Isolated from the enclosure, maximum 42 Vpk (DC + ACpk)

- Reference clock output

Connector	Rear panel, BNC connector
Output impedance	50 Ω (nominal), AC coupling
Frequency	10 MHz \pm 10 ppm (when operating on the internal reference clock) When the instrument is operating on an external reference clock, the input reference clock frequency is output as it is.
Output waveform	1 Vp-p / 50 Ω , square waveform

- DC power output

This is a power supply outlet that is used by the "5055 SIGNAL INJECTOR / PROPE" (optional) manufactured by the NF Corporation.

Connector	Rear panel, AUX
Output voltage	Approximately \pm 24 V

- Thermal printer

If the thermal printer described below is connected to the instrument via the USB port on the front panel, it is possible to print a hard copy of the image displayed on the LCD screen of this instrument.

Manufacturer	Seiko Instruments Inc.
Name	Thermal printer
Model	DPU-S445-00B-E

Only the printer described above can be used.

The printer is not handled by the NF Corporation. For more information on the printer, please refer to the instruction manual for the printer.

9.9 Miscellaneous specifications

- Power input
 - Voltage AC 100 V to 230 V $\pm 10\%$, however 250 V or less
 - Frequency 50 Hz/60 Hz ± 2 Hz
 - Power consumption 100 VA or less
 - Overvoltage category II

- Cooling Forced air cooling, rear exhaust

- Installation attitude Horizontal ($\pm 10^\circ$ or less)

- Environment

Range of ambient temperature and humidity

- Operation +5 °C to +40°C, 5 to 85% RH
(absolute humidity 1 to 25 g/m³, no condensation)
Altitude of 2000 m or less

- Storage -10°C to + 50°C, 5 to 95%RH
(absolute humidity 1 to 29 g/m³, no condensation)

- Pollution degree 2 (indoor use)

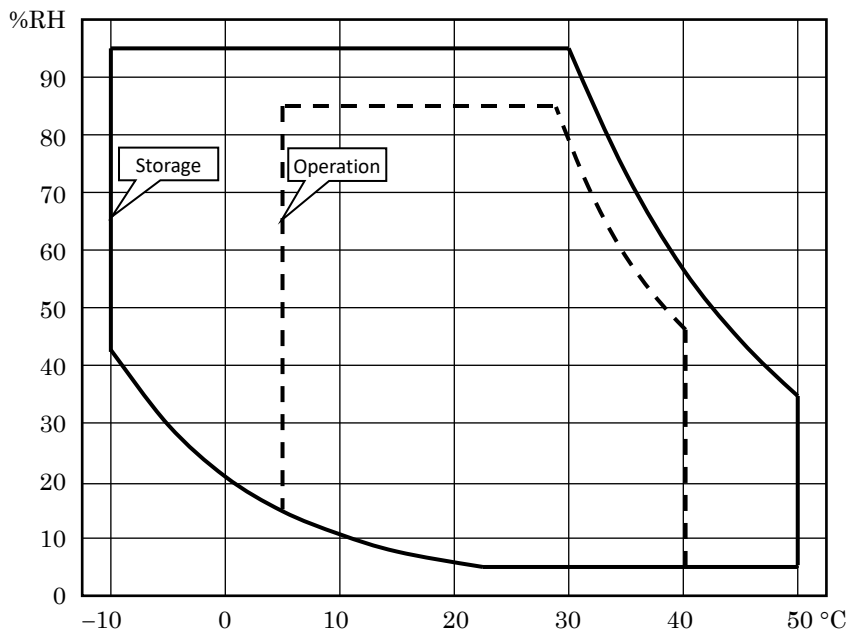

- Warm-up time 30 minutes
- External dimensions 430 mm (W) × 177 mm (H) × 350 mm (D) (excluding protruding parts)
- Weight Approximately 8.5 kg
(Main unit only, excluding accessories and optional equipment, etc.)
- Safety standards and EMC EN61010-1, EN61010-2-030
EN61326-1 (Group 1, Class A), EN61326-2-1
EN61000-3-2, EN61000-3-3
Note: Applies to products that have a CE marking displayed on the rear panel.
Note: The measurement error may occur if this equipment is exposed to a strong radiated radio frequency electromagnetic field.
- RoHS directive Directive 2011/65/EU

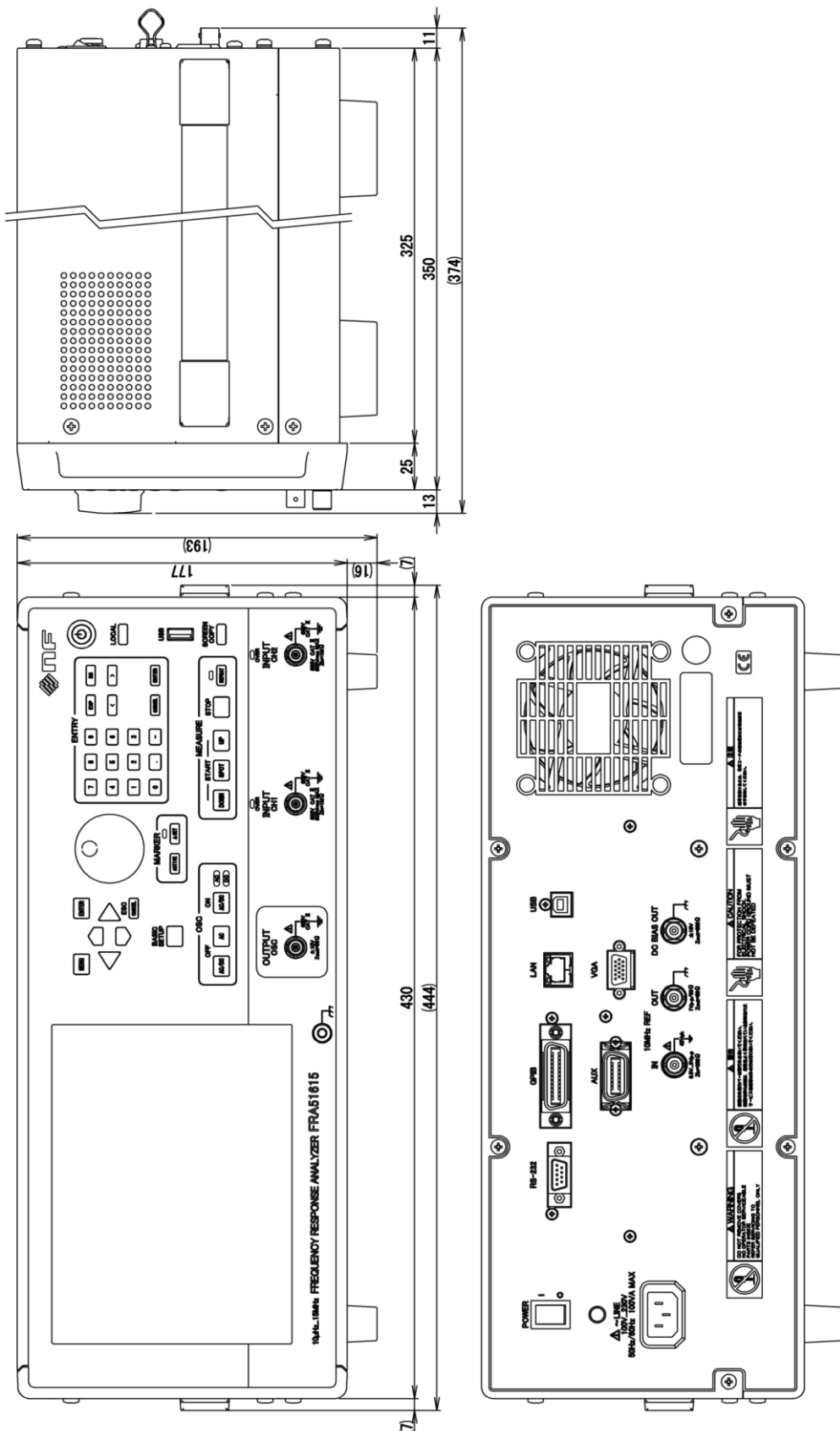

Figure 9-3 External dimensions

MICROSOFT SOFTWARE LICENSE TERMS

WINDOWS EMBEDDED 8.1 INDUSTRY PRO, WINDOWS EMBEDDED 8.1 INDUSTRY PRO TABLET, WINDOWS EMBEDDED 8.1 INDUSTRY PRO SMALL TABLET AND WINDOWS EMBEDDED 8.1 INDUSTRY PRO RETAIL

This is a license agreement between you and NF Corporation that describes your rights to use Windows Embedded 8.1 Industry Pro, Windows Embedded 8.1 Industry Pro Tablet, Windows Embedded 8.1 Industry Pro Small Tablet or Windows Embedded 8.1 Industry Pro Retail ("Windows Embedded Industry").

The software on this device includes software licensed from Microsoft Corporation or its affiliate.

For your convenience, we've organized this agreement into two parts. The first part includes introductory terms phrased in a question and answer format and the Additional Terms follow and contain greater detail. You should review the entire agreement, including any linked terms, because all of the terms are important and together create this contract that applies to you. You can review linked terms by pasting the forward link into your browser window once the software is running. **The Additional Terms contain a binding arbitration clause and class action waiver. If you live in the United States, these affect your rights to resolve a dispute with NF Corporation, or with Microsoft, so you should read them carefully.**

By accepting this agreement or using the software, you agree to all of these terms and consent to the transmission of certain information during activation and for Internet-based features of the software. If you do not accept and comply with these terms, you may not use the software or its features. Instead, you may contact NF Corporation to determine its return policy for a refund or credit under that policy.

How can I use the software? We do not sell our software or your copy of it – we only license it. The software may require a key to install or access it. If it does, you are responsible for the use of keys assigned to you. You should not share the keys with third parties.

May I make a backup copy? Yes, you may make a single copy of the software for backup purposes, and use that backup copy as described below.

What about updating the software? If the software covered by this agreement is an update to your existing operating system software, the update replaces the original software. You do not retain any rights to the original software after it has been updated and you may not continue to use it or transfer it in any way. This agreement governs your rights to use the update software and replaces the agreement for the software from which it was updated. After the update is complete, some apps may not migrate or may be incompatible with Windows Embedded 8.1 Industry Pro and additional software may be required to play back or record certain types of media, including DVDs.

Can I transfer the software to another device? You may transfer the software directly to another user, only with the licensed device. The transfer must include the software, proof of purchase, and, if provided with the device, an authentic Windows label such as the certificate of authenticity label, including the product key. You may not keep any copies of the software or any earlier version. Before any permitted transfer, the other party must agree that this agreement applies to the transfer and use of the software.

How does Internet activation work? The first time you or NF Corporation connect to the Internet while using the software, the software will automatically contact Microsoft or its affiliate to confirm the software is genuine, and the license is associated with the licensed device. This process is called "activation." Because activation is meant to identify unauthorized changes to the licensing or activation functions of the software, and to otherwise prevent unlicensed use of the software, **you or NF Corporation may not bypass or circumvent activation.**

Does the software collect my personal information? If you connect your device to the Internet, some features of the software may connect to Microsoft or service provider computer systems to send or receive information, including personal information. You may not always receive a separate notice when they connect. If you choose to use any of these features, you agree to send or receive this information when using that feature. Many of these features can be switched off or you can choose not to use them.

How does Microsoft use your information? Microsoft uses the information it collects through the software features to upgrade or fix the software and otherwise improve our products and services. In certain circumstances, Microsoft also share it with others. For example, Microsoft share error reports with relevant hardware and software vendors, so that they can use the information to improve how their products run with Microsoft products. You agree that Microsoft may collect, use and disclose the information as described in the Privacy Statements at go.microsoft.com/fwlink/?LinkID=301572.

What does this agreement apply to? This agreement applies to the software, the media on which you received the software, if received on media, and any Microsoft updates, supplements, and services for the software, unless other terms come with them. If you obtain updates or supplements directly from Microsoft, then Microsoft, and not NF Corporation, licenses those to you.

Are there things I am not allowed to do with the software? Yes. Because the software is licensed, not sold, NF Corporation and Microsoft reserve all rights (such as rights under intellectual property laws) not expressly granted in this agreement. In particular, this license does not give you any right to, and you may not: use the software for commercial software hosting services; use features of the software separately; publish, copy (other than the permitted backup copy), rent, lease or lend the software; transfer the software (except as permitted by this agreement); attempt to circumvent technical protection measures in the software, reverse engineer, decompile, or disassemble the software, except if the laws where

you live permit this even when our agreement does not. In that case, you may do only what your law allows. When using Internet-based features or Microsoft Family Safety, you may not use those features in any way that could interfere with anyone else's use of them, or to try to gain access to any service, data, account or network, in an unauthorized manner.

ADDITIONAL TERMS

1. License Rights

The software license is permanently assigned to the device (physical hardware system) with which you acquired the software. You may only use the software on that device.

- a. Specific Use. NF Corporation designed licensed device for a specific use. You may only use the software for that use.
- b. Usage rights relative to Windows Embedded 8.1 Industry Pro Retail. You may use the software with a point of service "POS" application. A POS application is a software application which provides any of the following functions:
 - process sales and service transactions
 - scan and track inventory
 - record or transmit customer information
 - perform related management functions
 - provide information directly and indirectly to customers about available products and services.

You may not use the software on a device with automated teller machine ("ATM") as the primary functionality.

If your industry system performs desktop functions, then you must ensure that they:

- are only used to support the industry application, and
- operate only when used with the industry application.

"Desktop functions," as used in this agreement, include word processing, spreadsheets, database, scheduling or personal finance. Your industry system must not be used as a general-purpose personal computing device. You may use other programs with the software as long as the other programs

- directly support the manufacturer's specific use for the device, or

-
- provide system utilities, resource management, or anti-virus or similar protection.
- c. Cloud Applications. If your industry system uses Internet browsing functionality to connect to cloud hosted applications:
- no desktop functions may run locally on the industry system, and
 - any files that result from the use of desktop functions may not be permanently stored on the industry system.
- d. Storage/Network Use. You may also store or install one (1) copy of the software on a storage device, such as network server, used only to install or run the software on your other industry systems over an internal network; however, you must acquire and dedicate an additional license for each separate industry system on or from which the software is installed, used, accessed, displayed or run. Except as otherwise permitted by Remote Assistance features described below, a license for the software may not be shared or used concurrently on different industry systems.
- e. Multiple or Pooled Connections. Hardware or software you use to multiplex or pool connections, or reduce the number of devices that access or use the software, does not reduce the number of licenses you need. You may only use such hardware or software if you have a license for each copy of the software you are using.
- f. Device Connections. You may permit a maximum of twenty (20) computers or other electronic devices (each a "Device") to connect via Server Message Bloc (SMB) to the industry system to utilize one or more of the following services of the software: file services, print services, Internet information services, Internet connection sharing and telephony services. The twenty connection maximum includes any indirect connections made through "multiplexing" or other software or hardware which pools or aggregates connections. Unlimited inbound connections are allowed via TCP/IP (Transmission Control Protocol ("TCP") and the Internet Protocol ("IP").
- g. Remote Access. The software contains Remote Desktop and Remote Assistance technologies that enable the software or applications installed on the licensed device to be accessed remotely from other devices.
- Remote Desktop. The single primary user of the licensed device may access a session from any other device using Remote Desktop or similar technologies. A "session" means the experience of interacting with the software, directly or indirectly, through any combination of input, output and display peripherals. Other users, one at a time, may access the licensed software running on this

host device, from any device using Remote Desktop, but only if the remote device is separately licensed to run Windows Embedded 8.1 Industry Pro.

- Remote Assistance. You may use Remote Assistance or similar technologies to share an active session without obtaining any additional licenses for the software. Remote Assistance allows one user to directly connect to another user's device, usually to correct problems.
- h. Device. In this agreement, "device" means a hardware system with an internal storage device capable of running the software. A hardware partition or blade is considered to be a device. The software is licensed to run on up to two processors on the licensed device.
- i. Multiple versions. The software includes multiple versions (such as 32-bit and 64-bit versions), and you or NF Corporation may install only one of those versions at a time. Installing the 32-bit version of Windows Embedded 8.1 Industry Pro on this system requires a change to the BIOS settings to legacy BIOS mode. If you switch to the 64-bit version of Windows Embedded 8.1 Industry Pro from the 32-bit version of Windows Embedded 8.1 Industry Pro, then you should revert back to the original BIOS settings. If you do not revert back to these BIOS settings when switching back to the 64-bit version, the following Windows Embedded 8.1 Industry Pro functionalities will not work as they rely on UEFI mode boot:
 - Secure Boot,
 - Seamless Boot experience,
 - Network unlock for Bitlocker for computer with a Trusted Platform Module (TPM) and
 - eDrive support.

Reverting back to UEFI mode will require a hard drive reformat. All data and personal settings will be lost. It is highly recommended that you back up your data before you revert back to UEFI mode.

2. Binding Arbitration and Class Action Waiver

- a. Application. If you live in the United States, this Section 2 applies to any dispute **EXCEPT IT DOES NOT INCLUDE A DISPUTE RELATING TO THE ENFORCEMENT OR VALIDITY OF YOUR, NF Corporation'S, MICROSOFT'S, OR EITHER OF OUR LICENSORS' INTELLECTUAL PROPERTY RIGHTS**. Dispute means any dispute, action, or other controversy between you and NF Corporation, or you and Microsoft, concerning the software (including its price) or this agreement, whether in contract, warranty, tort, statute, regulation, ordinance, or any other legal or equitable basis. "Dispute" will be given the broadest possible meaning allowable

under law.

- b. Notice of Dispute. In the event of a dispute, you, or NF Corporation must give the other a Notice of Dispute, which is a written statement of the name, address and contact information of the party giving it, the facts giving rise to the dispute, and the relief requested. You must send any Notice of Dispute by U.S. Mail to NF Corporation, ATTN: Legal Department. NF Corporation will send any Notice of Dispute to your U.S. Mail address if available, or otherwise to your e-mail address. You and NF Corporation will attempt to resolve any dispute through informal negotiation within 60 days from the date the Notice of Dispute is sent. After 60 days, you or NF Corporation may commence arbitration.
- c. Small claims court. You may also litigate any dispute in small claims court in your county of residence or the NF Corporation's principal place of business, if the dispute meets all requirements to be heard in the small claims court. You may litigate in small claims court whether or not you negotiated informally first.
- d. Binding arbitration. **If you and NF Corporation, or Microsoft, do not resolve any dispute by informal negotiation or in small claims court, any other effort to resolve the dispute will be conducted exclusively by binding arbitration governed by the Federal Arbitration Act ("FAA"). You are giving up the right to litigate (or participate in as a party or class member) all disputes in court before a judge or jury.** Instead, all disputes will be resolved before a neutral arbitrator, whose decision will be final except for a limited right of appeal under the FAA. Any court with jurisdiction over the parties may enforce the arbitrator's award.
- e. Class action waiver. **Any proceedings to resolve or litigate any dispute in any forum will be conducted solely on an individual basis. Neither you, NF Corporation, nor Microsoft, will seek to have any dispute heard as a class action, private attorney general action, or in any other proceeding in which any party acts or proposes to act in a representative capacity. No arbitration or proceeding will be combined with another without the prior written consent of all parties to all affected arbitrations or proceedings.**
- f. Arbitration procedure. Any arbitration will be conducted by the American Arbitration Association (the "AAA"), under its Commercial Arbitration Rules. If you are an individual and use the software for personal or household use, or if the value of the dispute is \$75,000 or less whether or not you are an individual or how you use the software, the AAA Supplementary Procedures for Consumer-Related Disputes will also apply. To commence arbitration, submit a Commercial Arbitration Rules Demand for Arbitration form to the AAA. You may request a telephonic or in-person hearing by following the AAA rules. In a dispute involving \$10,000 or less, any hearing will be telephonic unless the arbitrator finds good

cause to hold an in-person hearing instead. For more information, see adr.org or call 1-800-778-7879. You agree to commence arbitration only in your county of residence or in the NF Corporation's principal place of business. NF Corporation agrees to commence arbitration only in your county of residence. The arbitrator may award the same damages to you individually as a court could. The arbitrator may award declaratory or injunctive relief only to you individually, and only to the extent required to satisfy your individual claim.

g. Arbitration fees and incentives

- i. Disputes involving \$75,000 or less. NF Corporation will promptly reimburse your filing fees and pay the AAA's and arbitrator's fees and expenses. If you reject the NF Corporation's last written settlement offer made before the arbitrator was appointed ("last written offer"), your dispute goes all the way to an arbitrator's decision (called an "award"), and the arbitrator awards you more than the last written offer, NF Corporation will give you three incentives: (1) pay the greater of the award or \$1,000; (2) pay twice your reasonable attorney's fees, if any; and (3) reimburse any expenses (including expert witness fees and costs) that your attorney reasonably accrues for investigating, preparing, and pursuing your claim in arbitration. The arbitrator will determine the amounts.
- ii. Disputes involving more than \$75,000. The AAA rules will govern payment of filing fees and the AAA's and arbitrator's fees and expenses.
- iii. Disputes involving any amount. In any arbitration you commence, NF Corporation will seek its AAA or arbitrator's fees and expenses, or your filing fees it reimbursed, only if the arbitrator finds the arbitration frivolous or brought for an improper purpose. In any arbitration NF Corporation commences, it will pay all filing, AAA, and arbitrator's fees and expenses. It will not seek its attorney's fees or expenses from you in any arbitration. Fees and expenses are not counted in determining how much a dispute involves.

- h. Claims or disputes must be filed within one year. To the extent permitted by law, any claim or dispute under this agreement to which Section 2 applies must be filed within one year in small claims court (Section 2.c) or in arbitration (Section 2.d). The one-year period begins when the claim or dispute first could be filed. If such a claim or dispute is not filed within one year, it is permanently barred.
- i. Severability. If the class action waiver in Section 2.e is found to be illegal or unenforceable as to all or some parts of a dispute, then Section 2 will not apply to those parts. Instead, those parts will be severed and proceed in a court of law, with the remaining parts proceeding in arbitration. If any other provision of Section 2 is found to be illegal or unenforceable, that provision will be severed

with the remainder of Section 2 remaining in full force and effect.

- j. Third-Party Beneficiary. Microsoft Corporation is not a party to this agreement but is a third-party beneficiary of your and the NF Corporation's agreement to resolve disputes through informal negotiation and arbitration. If your dispute is with Microsoft, Microsoft agrees to do everything NF Corporation agrees to do in Section 2, and you agree to do everything regarding Microsoft that Section 2 requires you to do regarding NF Corporation. Mail a Notice of Dispute with Microsoft to Microsoft Corporation, ATTN: LCA ARBITRATION, One Microsoft Way, Redmond, WA 98052-6399. You may commence an arbitration or small claims court case against Microsoft in your county of residence or King County, Washington.

3. Choice of Law

The laws of the state or country where you live govern all claims and disputes concerning the software or this agreement, including breach of contract claims and claims under state consumer protection laws, unfair competition laws, implied warranty laws, for unjust enrichment, and in tort, except that the FAA governs all provisions relating to arbitration. If you acquired the software in any other country, the laws of that country apply. This agreement describes certain legal rights. You may have other rights, including consumer rights, under the laws of your state or country. You may also have rights with respect to the party from whom you acquired the software. This agreement does not change those other rights if the laws of your state or country do not permit it to do so.

4. Activation

- a. More on how activation works. The software will notify you or NF Corporation, if NF Corporation activates the software, whether the installed copy of the software is properly licensed. During activation, the software will send information about the software and your device to Microsoft. This information includes the version, language, and product key of the software, the Internet protocol address of the device, and information derived from the hardware configuration of the device. For more information about activation, see go.microsoft.com/fwlink/?linkid=280262. If the licensed device is connected to the Internet, the software will automatically connect to Microsoft for activation. You can also activate the software manually by Internet or telephone. In either case, Internet and telephone service charges may apply.
- b. Re-activation. Some changes to your device components or the software may require re-activation of the software.
- c. Activation failure. During online activation, if the licensing or activation functions of the software are found to be counterfeit, improperly licensed, or include

unauthorized changes, activation will fail and the software will attempt to repair itself by replacing any tampered Microsoft software with genuine Microsoft software. The software will notify you or NF Corporation if the installed copy of the software is improperly licensed or includes unauthorized changes. In addition, you or NF Corporation may receive reminders to obtain a properly licensed copy of the software. You may not be able to obtain certain updates or upgrades from Microsoft if your copy of the software is found to be improperly licensed.

5. Internet-Based Features; Privacy

Some software features use Internet protocols, which send to Microsoft (or its suppliers or service providers) device information, such as your Internet protocol address, the type of operating system, browser and name and version of the software you are using, the language code of the device where you installed the software, and other information described below, in the Windows Privacy Statement at go.microsoft.com/fwlink/?linkid=280262, or in the Windows Embedded user interface. Microsoft uses this information to make the Internet-based features available to you, in accordance with the Windows Privacy Statement at go.microsoft.com/fwlink/?linkid=301572 and information that may be presented to you in the Windows Embedded user interface. Some Internet-based features may be delivered and updated at a later date if, for example, you acquire an application that relies on one of those services, or to help make the software safer or more reliable. Internet features include, but are not limited to the features described below, in the Windows 8.1 Privacy Statement at go.microsoft.com/fwlink/?linkid=301572 and the Windows Embedded user interface. NF Corporation may have elected to turn on one or more of the following features in the licensed device.

- a. Accelerators. When you click on or move your mouse over an Accelerator in Internet Explorer, any of the following may be sent to the applicable service provider (which may not be Microsoft): the title and full web address or URL of the current webpage, standard device information, and any content you have selected. For more information, see go.microsoft.com/fwlink/?linkid=280122.
- b. Cookies. If you choose to use online features in the software, such as online Help and Support, cookies may be set. To learn how to block, control and delete cookies, please read the cookies section of the Privacy Statement at go.microsoft.com/fwlink/?linkid=74170.
- c. Digital Certificates. The software uses digital certificates to confirm the identity of Internet users sending X.509 standard encrypted information, to digitally sign files and macros, and to verify the integrity and origin of the file contents. The software may retrieve and update certificates and certificate revocation lists, and the list of trusted certification authorities, over the Internet.
- d. Feedback Features. The Customer Experience Improvement Program automatically

sends to Microsoft anonymous information about your hardware and how you use this software. The Help Experience Improvement Program (HEIP) automatically sends to Microsoft information about the version of Windows that your PC device is running and about how you use Windows Help and Support, including queries you enter when you search Windows Help and Support and any ratings or feedback on the Help topics presented to you. Windows Error Reporting automatically sends reports to Microsoft that describes which software components had errors. These reports may include memory dumps. From time-to-time, Microsoft will also download a small file to your device that permits them to collect information about specific errors you have while using the software. The data collected by these features helps Microsoft improve their software.

- e. IPv6 Network Address Translation (NAT) Traversal service (Teredo). Each time you start your licensed device, Teredo will attempt to locate a public Internet Protocol version 6 (IPv6) service on the Internet. This occurs automatically when your licensed device is connected to a public or private network, but does not occur on managed networks such as enterprise domains. If you use a program that requires Teredo to use IPv6 connectivity, or if you configure your firewall to always enable IPv6 connectivity, then Teredo will periodically contact the Microsoft Teredo service over the Internet. The only information sent to Microsoft is standard computer information and the name of the service requested (for example teredo.ipv6.microsoft.com). The information sent from your device by Teredo is used to determine if your device is connected to the Internet and if it can locate a public IPv6 service. Once the service is located, information is sent to maintain a connection with the IPv6 service.
- f. Malicious Software Removal. The software may periodically scan for and remove malware from your device, using the malicious software removal tool most recently downloaded to your device. After the scan completes and at regular intervals, a report will be sent to Microsoft with specific information about malware detected, errors, and other information about your device. This information is used to help protect your device from malicious software, as well as to improve the software and other Microsoft products. You may disable the software's reporting functionality by following the instructions found at go.microsoft.com/fwlink/?linkid=241725.
- g. Network Awareness. This feature determines whether a system is connected to a network by either passive monitoring of network traffic or active DNS or HTTP queries. The query only transfers standard TCP/IP or DNS information for routing purposes. You can switch off the active query feature through a registry setting.
- h. Plug and Play and Plug and Play Extensions. Your device may not have the drivers

needed to communicate with hardware that you connect to your device. If so, the update feature of the software can obtain and install the correct driver on your device. An administrator can disable this update feature.

- i. Search Provider Update. The software will download an update to the data on your device about search providers. This update upgrades your providers with the latest features, such as new icons or search suggestions. This is a one-time update, but the software will try to perform the update several times if it does not successfully download the update. For more information, see go.microsoft.com/fwlink/?linkid=280122.
- j. SmartScreen Filter. If enabled, the SmartScreen Filter will check the addresses of webpages and downloads you attempt to view against a frequently updated list of webpages and downloads that have been reported to Microsoft as unsafe or suspicious. SmartScreen will also check downloaded programs that you attempt to run against a list of commonly downloaded or run programs to help you make more informed trust decisions. More information can be found by visiting the Internet Explorer Privacy Statement at go.microsoft.com/fwlink/?linkid=280122. By enabling SmartScreen in either Windows or Internet Explorer, you consent to this feature, and you agree to use the SmartScreen Filter only in conjunction with Windows or Internet Explorer. You may not, either manually or by enabling or authorizing any software or service, copy, display, distribute, collect or store any data provided by the SmartScreen Filter.
- k. Windows Defender. If turned on, Windows Defender will search your device for many types of malicious software ("malware"), including viruses, worms, bots, rootkits, "spyware", "adware," and other potentially unwanted software. If you choose the "recommended" security settings when you first start using the software, such malware and other potentially unwanted software rated "high" or "severe" will automatically be removed. This removal may result in other software on your device ceasing to work or your breaching a license to use that software. It is possible that software that is not unwanted may be removed or disabled. If you use Windows Defender and Windows Update, Windows Defender is regularly updated through Windows Update.
- l. Windows digital rights management technology. Some content owners use Windows digital rights management technology (DRM) to protect their copyrights and other intellectual property, including by disabling the software's ability to play protected content if Windows DRM fails. You agree that Microsoft may include a revocation list with the licenses.
- m. Windows Media Player. When you use Windows Media Player it checks with Microsoft for compatible online music services in your region and new versions of the player. You may only use Windows Media Player as described at

go.microsoft.com/fwlink/?linkid=104605.

- n. Windows Update. If you use the Windows Update service in the software, updates or downloads to the Windows Update service will be required for proper functioning of the service, from time to time, and will be downloaded and installed without further notice to you.
- o. Windows Store for Windows Embedded 8.1 Industry Pro Retail. NF Corporation has disabled links to the Windows Store and you must not enable such links.
- p. Windows Store for Windows Embedded 8.1 Industry Pro, Windows Embedded 8.1 Industry Pro Tablet, Windows Embedded 8.1 Industry Pro Small Tablet. In addition to the terms of this agreement for Internet-based features, you may only use the Windows Store under the terms available at go.microsoft.com/fwlink/?linkid=246694. Those terms also contain information about Windows Notification Service. Windows apps or any preinstalled apps on your device may use Windows Notification Service. You agree that notifications may be sent to you as described in the Windows 8.1 Privacy Statement and Windows Store terms of service.

6. Proof of License

If you acquired the software on the device, or on a disc or other physical media, your proof of license is the genuine Microsoft certificate of authenticity label with the accompanying genuine product key, and proof of purchase from a supplier of genuine Microsoft software. A valid license may also include a Windows activation file installed on the device by NF Corporation. If there is a COA or other Windows label, it must be affixed to the device or appear on the NF Corporation's software packaging or peripherals when purchased. If you receive an authenticity label separate from your device, it does not establish proof of license.

If you acquired and downloaded the software online, your proof of license is the genuine Microsoft product key for the software that you received with your purchase, and your proof of purchase from an authorized electronic supplier of genuine Microsoft software. Proof of purchase may be subject to verification by your merchant's records.

7. Updates and Upgrades

You may only obtain updates or upgrades for the software from Microsoft or authorized sources. Certain upgrades, support, and other services may be offered only to users of genuine Microsoft software. For more information about Genuine Windows, see go.microsoft.com/fwlink/?linkid=104612. To identify genuine Microsoft software, see howtotell.com.

8. Fonts, Icons, Images, and Sounds

- a. Font components. While the software is running, you may use its fonts to display and print content. You may temporarily download the fonts to a printer or other output device to print content, and you may embed fonts in content only as permitted by the embedding restrictions in the fonts.
- b. Icons, images, and sounds. While the software is running, you may access and use its icons, images, sounds, and media only from the licensed device. You may not share the sample images, sounds and media provided with the software or use them for any other purpose.

9. .NET Framework

The software includes one or more components of the .NET Framework, which you may use only as described at go.microsoft.com/fwlink/?linkid=66406, if you use the .NET Framework components to conduct internal benchmark testing.

10. H.264/AVC and MPEG-4 Visual Standards and VC-1 Video Standards

THIS PRODUCT IS LICENSED UNDER THE AVC, THE VC-1, AND THE MPEG-4 PART 2 VISUAL PATENT PORTFOLIO LICENSES FOR THE PERSONAL AND NON-COMMERCIAL USE OF A CONSUMER TO (i) ENCODE VIDEO IN COMPLIANCE WITH THE ABOVE STANDARDS ("VIDEO STANDARDS") AND/OR (ii) DECODE AVC, VC-1, AND MPEG-4 PART 2 VIDEO THAT WAS ENCODED BY A CONSUMER ENGAGED IN A PERSONAL AND NON-COMMERCIAL ACTIVITY AND/OR WAS OBTAINED FROM A VIDEO PROVIDER LICENSED TO PROVIDE SUCH VIDEO. NO LICENSE IS GRANTED OR SHALL BE IMPLIED FOR ANY OTHER USE. ADDITIONAL INFORMATION MAY BE OBTAINED FROM MPEG LA, L.L.C SEE WWW.MPEGLA.COM.

11. Adobe Flash Player

The software may include a version of Adobe Flash Player. You agree that your use of the Adobe Flash Player is governed by the license terms for Adobe Systems Incorporated at go.microsoft.com/fwlink/?linkid=248532. Adobe and Flash are either registered trademarks or trademarks of Adobe Systems Incorporated in the United States and/or other countries.

12. Third Party Programs

This software contains certain third-party programs. You agree that your use of them is governed by the license terms provided with those programs.

13. Not Fault Tolerant

The software is not fault tolerant. NF Corporation installed the software on the device and is responsible for how it operates on the device.

14. Support Services

Contact NF Corporation for support options. Refer to the support number provided with the device.

15. Disclaimer of Warranty

The software is licensed "as-is." You bear the risk of using it. Microsoft gives no express warranties, guarantees or conditions. You may have additional consumer rights under your local laws which this agreement cannot change. To the extent permitted under your local laws, NF Corporation and Microsoft excludes the implied warranties of merchantability, fitness for a particular purpose and non-infringement. For Australia only: You may have statutory guarantees under the Australian Consumer Law and nothing in these terms is intended to affect those rights.

16. Limitation on and Exclusion of Remedies and Damages

You can recover from Microsoft and its suppliers only direct damages up to the amount you paid for the software. You cannot recover any other damages, including consequential, lost profits, special, indirect or incidental damages.

This limitation applies to

- anything related to the software, services, content (including code) on third party Internet sites, or third party programs; and
- claims for breach of contract, breach of warranty, guarantee or condition, strict liability, negligence, or other tort to the extent permitted by applicable law.

It also applies even if

- repair, replacement or a refund for the software does not fully compensate you for any losses; or
- Microsoft knew or should have known about the possibility of the damages.

Some states do not allow the exclusion or limitation of incidental or consequential damages, so the above limitation or exclusion may not apply to you. They also may not apply to you because your country may not allow the exclusion or limitation of incidental, consequential or other damages.

17. Export Restrictions

You must comply with all domestic and international export laws and regulations that apply to the software, which include restrictions on destinations, end users, and end use. For further information on geographic and export restrictions, visit go.microsoft.com/fwlink/?linkid=141397 and microsoft.com/exporting.

18. Entire Agreement

This agreement (together with terms accompanying any software supplements, updates, and services that are provided by NF Corporation, or Microsoft and that you use), and the terms contained in web links listed in this agreement are the entire agreement for the software and any such supplements, updates, and services (unless Microsoft provides other terms with such supplements, updates, or services). You can review the terms at any of the links in this agreement after your software is running by typing the URLs into your browser address bar, and you agree to do so. You agree, that for each service or included app, if any, that is governed by this agreement and also specific terms linked in this agreement, you will read the terms for that service before using the service. You understand that by using the service, you ratify this agreement and the linked terms. There are also informational links in this agreement. The links containing terms that bind you and us are:

- go.microsoft.com/fwlink/?LinkID=301572 (Windows Embedded Industry 8.1 Privacy Statement)
- go.microsoft.com/fwlink/?linkid=280262 (Windows 8.1 Privacy Statement)
- go.microsoft.com/fwlink/?linkid=281874 (Arbitration Procedure)
- go.microsoft.com/fwlink/?linkid=104605 (Windows Media Player)
- go.microsoft.com/fwlink/?linkid=246694 (Windows Store Terms of Use)
- go.microsoft.com/fwlink/?linkid=246338 (Microsoft Services Agreement)
- xbox.com/legal/livetou (Xbox LIVE Terms of Use)
- go.microsoft.com/fwlink/?linkid=66406 (.NET Framework Terms)
- go.microsoft.com/fwlink/?linkid=248532 (Adobe Flash Player License Terms)

(Blank)

WARRANTY

NF Corporation certifies that this product was thoroughly tested and inspected and found to meet its published specifications when it was shipped from our factory. In the unlikely event that you experience an issue during use, please contact our company or agency of our company from which you purchased the product.

All NF products are warranted against defects in materials and workmanship for a period of one year from the date of shipment. During the warranty period, NF will repair the defective product without any charge for the parts and labor.

For repair service under warranty, the product must be returned to either NF or an agent designated by NF. The Purchaser shall prepay all shipping cost, duties and taxes for the product to NF from another country, and NF shall pay shipping charges to return the product to the purchaser.

This warranty shall not apply when corresponding to following particulars.

- A) Failure caused by improper handling or use of the product in a manner that does not conform with the provisions of the Instruction Manual.
- B) Failure or damage caused by transport, dropping, or other handling of the product after purchase.
- C) Failure caused by repair, adjustment, or modification of the product by a company, organization, or individual not approved by NF.
- D) Failure caused by abnormal voltage or the influence of equipment connected to this product.
- E) Failure caused by the influence of supply parts from the customer.
- F) Failure caused by such as corrosion that originate in the use of causticity gas, organic solvent, and chemical.
- G) Failure caused by the insect or small animal that invaded from the outside.
- H) Failure or damage caused by fire, earthquakes, flood damage, lightning, war, or other uncontrollable accident.
- I) Failure caused by the reason that was not able to be foreseen by the science and technology level when shipped from our company.
- J) Replacement and replenishment of consumables such as batteries.

NF Corporation

Request for Repair

When a failure occurred and the product was found to be defective or you have any uncertainty, please get in touch with NF Corporation or its authorized agent.

In such a case, let us know the model name (or product name), serial number (SERIAL No. given on the nomenclature plate), and symptom and operating conditions as detail as possible.

Though we will make efforts to reduce the repair period, when five or more years have passed since you purchased the product, it may take time due to, for instance, the out of stock of repair parts.

Also, if the production of repair parts is discontinued, the product is extremely damaged, or the product is modified, we may decline the repair.

WABUN: (DA00057751-005)

If there are any misplaced or missing pages, we will replace the manual.
Contact the sales representative.

NOTES

- Reproduction of the contents of this manual is forbidden by applicable laws.
- The contents of this manual may be revised without notice.
- Information provided in this manual is intended to be accurate and reliable. However, we assume no responsibility for any damage regarding the contents of this manual.
- We assume no responsibility for influences resulting from the operations in this manual.

Copyright 2023. **NF Corporation**

FRA51615 INSTRUCTION MANUAL (OPERATION)

NF Corporation

6-3-20, Tsunashima Higashi, Kohoku-ku, Yokohama

223-8508 JAPAN

Phone +81-45-545-8128 Fax +81-45-545-8187

